

The TCP/IP Guide

Version 3.0
September 20, 2005

Charles M. Kozierok



"aquarelle" © 2003 Charles M. Kozierok

Copyright Notice and Disclaimers

Copyright © 2001-2005 Charles M. Kozierok. All Rights Reserved.

This electronic book is made available only under the terms and provisions of the TCPIPGuide.com Electronic Book License Agreement (<http://www.tcpipguide.com/la.htm>), and is protected under United States and international copyright law. No part of this document may be reproduced, distributed, stored in a retrieval system or transmitted in any form or by any means—be it electronic, mechanical, photographic, magnetic or otherwise—without the prior written permission of the author.

Although every reasonable effort has been made to ensure that the information contained in this document is correct as of the time of publishing, there is always the possibility of error with any technical resource, either due to mistakes made by the author or the author's sources. Accordingly, the author does not guarantee or warrant the accuracy or completeness of any of the information in this electronic book, and is not responsible for any errors or omissions. This document is designed as a general educational resource; the author is not rendering any professional service. Information contained in this book should be verified with an appropriate professional before undertaking any project.

The information in this electronic book is provided on an “as is” basis. The author specifically makes no representations or warranties of any kind regarding the accuracy, completeness, applicability, performance, merchantability, or fitness for any particular purpose of the content herein, even if the author has been informed in advance of such intended purpose. The author shall not be liable to any person or entity with respect to any damage or loss whatever, whether direct or indirect, whether incidental or consequential, resulting or alleged to have resulted from the use of the information in this electronic book.

All trademarks and service marks used in this document are the property of their respective owners. All names and other terms used in this document that are believed to be trademarks or service marks have been treated as proper nouns to distinguish them from non-trademarked terms. No claim is made or implied regarding the trademark status of any term based on its use in this document.

Dedication

This Guide is dedicated to my family: my wife Robyn and my three sons, Ryan, Matthew and Evan.

I suppose that it's a cliché to dedicate a book to your wife. If so, it's for a very good reason: who plays a more important role in the life of an author than his or her spouse? Robyn is my partner; the person who is always there; the one who shares my life in so many ways. The expression about a great woman being behind every good man is true, yet my wife is deserving of recognition for reasons that go far beyond the usual reasons such as being "supportive".

Financially, she agreed to take on a regular working position to make it possible for me to spend time on a very long project with an uncertain payoff. She took on most of the tasks of taking our children to school and dealing with their needs, to give me time to write. She also gracefully agreed to "do without" many things that many other wives would not have been too happy about.

But most of all, she deserves a world of credit for putting up with *me*. ☺ For constantly reassuring me that it was okay that I was spending years on a project that might not be successful. For listening to me talk for countless hours, and for giving her opinions on many portions of my writing, all on a subject that really doesn't interest her at all. And most importantly, for encouraging me when I felt this was a waste of time, and even kicking me in the butt when I felt like giving up. Without Robyn, this Guide simply would not exist. Thanks, R.

My three boys deserve credit for similar reasons, but to a lesser extent. They have had to put up with my constantly sitting at the computer trying to tune them out so I could concentrate; my too-frequent grouchy moods; and my reluctance to spend time with them when I had work on my plate. I am sure there were many times that they wished I just had a regular "day job".

Ryan, my big boy, has been very patient in waiting for me to finish this project so we can resume several activities that we used to engage in regularly. Matthew, my fun-loving and rambunctious middle son, has also had to deal with my not having as much time as I would have liked to spend time with him. And little Evan has had a father working on a long-term project for his entire life! All three of my boys have been very understanding, and provided me with much needed joy and laughter at times when I needed it most.

Acknowledgments

I dedicated this Guide to my wife and children to reflect the important role they have played in life in general terms, and in accomplishing this Guide in particular. However, there are many others who also contributed to the completion of this document, and I'd like to take a moment to acknowledge them.

I want to thank my "original" family, my father Leon, and sisters Cari and Cindy, for being supportive and lending a helpful ear about various issues during the time that I've engaged in this project. Thanks also to my "adoptive" family, Eli, Marge, Larry and Steven. And I definitely want to thank the small group of close friends who have helped with ideas, advice and much needed laughs, especially Morley, Jeff, James and Jon, all of whom had to listen to far more of my blathering about this project over the last few years than any human being should have to tolerate. ☺

I would also like to specifically acknowledge the following individuals and organizations for their assistance:

- ☉ [Adobe Systems Incorporated](#), for providing this relatively unknown author with two important pieces of software that I used in creating this Guide. First, [Adobe Framemaker](#), one of the best desktop publishing programs around, which was used to format and publish this document. Second, [Adobe Photoshop](#), the industry standard program for photo and graphics editing, which was used for some of the graphics in this Guide, and will play a more central role in subsequent Guides containing more photographs.
- ☉ [SmartDraw.com](#), for the excellent SmartDraw diagramming software that was used to create most of the over 300 illustrations that appear in this Guide.
- ☉ Harald Heim of [The Plugin Site](#), for graciously providing me with two excellent Photoshop plugins that any serious photographer should consider: the [FocalBlade](#) sharpening tool and [ColorWasher](#) color-correction plugin.
- ☉ Fernando Gont and Barry Margolin, for their excellent technical review of The TCP/IP Guide, and their corrections and suggestions for improvement to the document.
- ☉ Bill Pollock, president and publisher of [No Starch Press](#), for constantly expressing his faith in my abilities as an author, for answering questions about the business, for being a sounding board, and for agreeing to publish The TCP/IP Guide in book form.
- ☉ [Tcat Houser](#), author and instructor, whose generosity, positive attitude and enthusiasm for my writing helped boost my confidence as I worked to complete this project.
- ☉ All the regulars at [The PC Guide Discussion Forums](#), for creating a fun community, keeping the site active, and agreeing to provide opinions on my writing. Thanks especially to Paleo Pete and mjc for doing such a great job of moderating the forums.
- ☉ Christine Hylands of [Junefire DTP](#), for assistance with creating certain graphics in this Guide, as well as designing its Web site (on short notice).
- ☉ Everyone who has supported The PC Guide and The TCP/IP Guide, financially and otherwise, which made it possible for me to spend time on this project.

I've probably missed a few people who should be on this list; I hope all who are deserving of my appreciation will forgive their omission and accept my thanks.

About The Author

I was born in 1966 in Windsor, Ontario, Canada and raised in nearby Toronto. I married my wife Robyn in 1990; we now live in southern Vermont with our three sons: Ryan (now 12), Matthew (9) and Evan (4).

I have had an interest in the field of computers ever since my early years, starting at the age of 14 when I received my first computer, an Apple II that was a gift from my parents. Since that time I have worked in various computer-related fields in hardware and software. In 1989 I obtained a Bachelor of Applied Science from the University of Waterloo, in Waterloo, Ontario, Canada. I completed my formal education in 1993 with two Master's degrees, in Management and in Electrical Engineering and Computer Science (EECS), from MIT.

After a brief “conventional” technical career, I created and published The PC Guide, an extensive online reference work on personal computers and in 1998 I decided to devote myself to my writing projects full time. The TCP/IP Guide was part of a larger networking project that I spent time on earlier this decade. I continue to work in the technical writing and editing field on various projects, for myself and other companies.

You may have noticed something missing here: no impressive listings of credentials. No, I'm not a New York Times best-selling author; I haven't been a professor at a prestigious Ivy League university for a quarter-century; neither am I a top executive at a Silicon Valley giant. In some ways, I am a student of technology, just like you are. And my experience over the years has shown me that many of the people who know the most about how technology works also have rather limited success in explaining what they know in a way that will allow me to understand it. My interests, and I believe my skills, lie not in being an expert, but an *educator*; in presenting complex information in a form that is sensible, digestible and fun to read.

When I am not working—all too rare these days—I spend time with my family and enjoy the peaceful quiet and natural beauty of the state of Vermont. I enjoy listening to many types of music, walking in the woods, hiking, and playing tennis. I am also an avid amateur photographer, with particular interests in nature and landscapes.

Table of Contents

Copyright Notice and Disclaimers.....	ii
Dedication.....	iii
Acknowledgments.....	iv
About The Author.....	v
Table of Contents.....	vi
List of Figures.....	xxiii
List of Tables.....	xxxii
The TCP/IP Guide: Introduction and "Guide To The Guide"	39
🕒 Introduction To The TCP/IP Guide.....	40
🕒 Goals of The TCP/IP Guide.....	41
🕒 Scope of The TCP/IP Guide.....	43
🕒 Structure and Organization of The TCP/IP Guide.....	44
🕒 TCP/IP Guide Features, Inserts and Icons.....	47
🕒 Tips For Using Adobe Acrobat Reader To View The TCP/IP Guide ...	49
🕒 Feedback and Suggestions.....	53
🕒 Version History.....	54
Networking Fundamentals.....	56
🕒 Introduction to Networking.....	57
🕒 What Is Networking?.....	57
🕒 The Advantages (Benefits) of Networking.....	58
🕒 The Disadvantages (Costs) of Networking.....	60
🕒 Fundamental Network Characteristics.....	62
🕒 Networking Layers, Models and Architectures.....	62
🕒 Protocols: What Are They, Anyway?.....	64
🕒 Circuit Switching and Packet Switching Networks.....	66
🕒 Connection-Oriented and Connectionless Protocols.....	69
🕒 Messages: Packets, Frames, Datagrams and Cells.....	71
🕒 Message Formatting: Headers, Payloads and Footers.....	73
🕒 Message Addressing and Transmission Methods: Unicast, Broadcast and Multicast Messages.....	74

• Network Structural Models and Client/Server and Peer-to-Peer Networking	77
• Types and Sizes of Networks	81
• Local Area Networks (LANs), Wireless LANs (WLANs) and Wide Area Networks (WANs) and Variants (CANs, MANs and PANs)	81
• Segments, Networks, Subnetworks and Internetworks.....	83
• The Internet, Intranets and Extranets	86
• Network Performance Issues and Concepts	88
• Putting Network Performance In Perspective.....	88
• Balancing Network Performance with Key Non-Performance Characteristics.....	89
• Performance Measurements: Speed, Bandwidth, Throughput and Latency.....	91
• Understanding Performance Measurement Units	94
• Theoretical and Real-World Throughput, and Factors Affecting Network Performance	96
• Simplex, Full-Duplex and Half-Duplex Operation	99
• Quality of Service (QoS)	101
• Network Standards and Standards Organizations.....	103
• Proprietary, Open and De Facto Standards	103
• Networking Standards	106
• International Networking Standards Organizations	107
• Networking Industry Groups	109
• Internet Standards Organizations (ISOC, IAB, IESG, IETF, IRSG, IRTF).....	110
• Internet Registration Authorities and Registries (IANA, ICANN, APNIC, ARIN, LACNIC, RIPE NCC).....	113
• Internet Standards and the Request For Comment (RFC) Process.....	115
• Backgrounder: Data Representation and the Mathematics of Computing	119
• Binary Information and Representation: Bits, Bytes, Nibbles, Octets and Characters	120
• Decimal, Binary, Octal and Hexadecimal Numbers.....	123
• Decimal, Binary, Octal and Hexadecimal Number Conversion.....	127
• Binary, Octal and Hexadecimal Arithmetic	131
• Boolean Logic and Logical Functions.....	132
• Bit Masking (Setting, Clearing and Inverting) Using Boolean Logical Functions.....	136
The Open System Interconnection (OSI) Reference Model....	140
• History of the OSI Reference Model	141

①	General Reference Model Issues	143
①	The Benefits of Networking Models.....	143
①	Why Understanding The OSI Reference Model Is Important To You ...	144
①	How To Use The OSI Reference Model.....	145
①	Comparing the OSI Reference Model to Network Architectures and Protocol Stacks	147
①	Key OSI Reference Model Concepts	148
①	OSI Reference Model Networking Layers, Sublayers and Layer Groupings	148
①	"N" Notation and Other OSI Model Layer Terminology	151
①	Interfaces: Vertical (Adjacent Layer) Communication	153
①	Protocols: Horizontal (Corresponding Layer) Communication	156
①	Data Encapsulation, Protocol Data Units (PDUs) and Service Data Units (SDUs).....	157
①	Indirect Device Connection and Message Routing	162
①	Understanding The OSI Reference Model: An Analogy	165
①	OSI Reference Model Layers.....	168
①	Physical Layer (Layer 1)	168
①	Data Link Layer (Layer 2).....	170
①	Network Layer (Layer 3).....	172
①	Transport Layer (Layer 4)	174
①	Session Layer (Layer 5)	177
①	Presentation Layer (Layer 6)	178
①	Application Layer (Layer 7)	180
①	OSI Reference Model Layer Mnemonics	182
①	OSI Reference Model Layer Summary	184
	TCP/IP Protocol Suite and Architecture.....	186
①	TCP/IP Overview and History	186
①	TCP/IP Services and Client/Server Operation	190
①	TCP/IP Architecture and the TCP/IP Model.....	193
①	TCP/IP Protocols	197
	TCP/IP Lower-Layer (Interface, Internet and Transport) Protocols (OSI Layers 2, 3 and 4)	203
①	TCP/IP Network Interface Layer (OSI Data Link Layer) Protocols	204
①	TCP/IP Serial Line Internet Protocol (SLIP) and Point-to-Point Protocol (PPP)	205
①	SLIP and PPP Overview and Role In TCP/IP	206
①	Serial Line Internet Protocol (SLIP)	209
①	Point-to-Point Protocol (PPP).....	213

❶	PPP Fundamentals and Operation	214
❶	PPP Overview, History and Benefits	214
❶	PPP Components and General Operation	217
❶	PPP Link Setup and Phases.....	219
❶	PPP Standards	223
❶	PPP Core Protocols: Link Control, Network Control and Authentication	228
❶	PPP Link Control Protocol (LCP).....	228
❶	PPP Network Control Protocols (IPCP, IPXCP, NBFCP and others)	233
❶	PPP Authentication Protocols: Password Authentication Protocol (PAP) and Challenge Handshake Authentication Protocol (CHAP)	236
❶	PPP Feature Protocols.....	240
❶	PPP Link Quality Monitoring/Reporting (LQM/LQR).....	240
❶	PPP Compression Control Protocol (CCP) and Compression Algorithms	242
❶	PPP Encryption Control Protocol (ECP) and Encryption Algorithms	245
❶	PPP Multilink Protocol (MP/MLP/MLPPP)	248
❶	PPP Bandwidth Allocation Protocol (BAP) and Bandwidth Allocation Control Protocol (BACP)	251
❶	PPP Protocol Frame Formats.....	254
❶	PPP General Frame Format.....	254
❶	PPP General Control Protocol Frame Format and Option Format	260
❶	PPP Link Control Protocol (LCP) Frame Formats.....	264
❶	PPP Authentication Protocol (PAP, CHAP) Frame Formats	267
❶	PPP Multilink Protocol (MP) Frame Format.....	271
❶	TCP/IP Network Interface / Internet "Layer Connection" Protocols.....	277
❶	Address Resolution and the TCP/IP Address Resolution Protocol (ARP).....	278
❶	Address Resolution Concepts and Issues.....	279
❶	The Need For Address Resolution	279
❶	Address Resolution Through Direct Mapping.....	282
❶	Dynamic Address Resolution	285
❶	Dynamic Address Resolution Caching and Efficiency Issues.....	286
❶	TCP/IP Address Resolution Protocol (ARP).....	289
❶	ARP Overview, Standards and History	290
❶	ARP Address Specification and General Operation	291
❶	ARP Message Format	294
❶	ARP Caching.....	296
❶	Proxy ARP	298
❶	TCP/IP Address Resolution For IP Multicast Addresses	301
❶	TCP/IP Address Resolution For IP Version 6.....	303
❶	Reverse Address Resolution and the TCP/IP Reverse Address Resolution Protocol (RARP).....	305
❶	TCP/IP Internet Layer (OSI Network Layer) Protocols	309
❶	Internet Protocol (IP/IPv4, IPng/IPv6) and IP-Related Protocols (IP NAT, IPSec, Mobile IP).....	310
❶	Internet Protocol Concepts and Overview	311
❶	IP Overview and Key Operational Characteristics	311
❶	IP Functions.....	313
❶	IP History, Standards, Versions and Closely-Related Protocols.....	314

④	Internet Protocol Version 4 (IP, IPv4).....	317
④	IP Addressing	318
④	IP Addressing Concepts and Issues	319
④	IP Addressing Overview and Fundamentals.....	319
④	IP Address Size, Address Space and "Dotted Decimal" Notation	323
④	IP Basic Address Structure and Main Components: Network ID and Host ID.....	325
④	IP Addressing Categories (Classful, Subnetted and Classless) and IP Address Adjuncts (Subnet Mask and Default Gateway).....	327
④	Number of IP Addresses and Multihoming	329
④	IP Address Management and Assignment Methods and Authorities	332
④	IP "Classful" (Conventional) Addressing	334
④	IP "Classful" Addressing Overview and Address Classes.....	334
④	IP "Classful" Addressing Network and Host Identification and Address Ranges	337
④	IP Address Class A, B and C Network and Host Capacities.....	341
④	IP Addresses With Special Meanings	343
④	IP Reserved, Loopback and Private Addresses	345
④	IP Multicast Addressing.....	348
④	Problems With "Classful" IP Addressing.....	351
④	IP Subnet Addressing ("Subnetting") Concepts.....	354
④	IP Subnet Addressing Overview, Motivation, and Advantages.....	355
④	IP Subnetting: "Three-Level" Hierarchical IP Subnet Addressing.....	357
④	IP Subnet Masks, Notation and Subnet Calculations.....	359
④	IP Default Subnet Masks For Address Classes A, B and C	364
④	IP Custom Subnet Masks.....	366
④	IP Subnet Identifiers, Subnet Addresses and Host Addresses.....	370
④	IP Subnetting Summary Tables For Class A, Class B and Class C Networks.....	373
④	IP Variable Length Subnet Masking (VLSM)	377
④	IP Subnetting: Practical Subnet Design and Address Determination Example	382
④	IP Subnetting Step #1: Requirements Analysis.....	383
④	IP Subnetting Step #2: The Key Design Trade-off: Partitioning Network Address Host Bits	384
④	IP Subnetting Step #3: Determining The Custom Subnet Mask.....	388
④	IP Subnetting Step #4: Determining Subnet Identifiers and Subnet Addresses	391
④	IP Subnetting Step #5: Determining Host Addresses For Each Subnet.....	397
④	IP Classless Addressing: Classless Inter-Domain Routing (CIDR) / "Supernetting".....	402
④	IP Classless Addressing and "Supernetting" Overview, Motivation, Advantages and Disadvantages.....	402
④	IP "Supernetting": Classless Inter-Domain Routing (CIDR) Hierarchical Addressing and Notation	406
④	IP Classless Addressing Block Sizes and "Classful" Network Equivalents.....	409
④	IP CIDR Addressing Example.....	411
④	IP Datagram Encapsulation and Formatting.....	417
④	IP Datagram Encapsulation.....	417
④	IP Datagram General Format.....	419
④	IP Datagram Options and Option Format	425
④	IP Datagram Size, Maximum Transmission Unit (MTU), Fragmentation and Reassembly.....	430

• IP Datagram Size, the Maximum Transmission Unit (MTU), and Fragmentation Overview	430
• IP Message Fragmentation Process.....	434
• IP Message Reassembly Process.....	438
• IP Datagram Delivery and Routing	441
• IP Datagram Direct Delivery and Indirect Delivery (Routing).....	441
• IP Routing Concepts and the Process of Next-Hop Routing	444
• IP Routes and Routing Tables	447
• IP Routing In A Subnet Or Classless Addressing (CIDR) Environment	449
• IP Multicasting	452
• Internet Protocol Version 6 (IPv6) / IP Next Generation (IPng).....	454
• IPv6 Overview, Changes and Transition	455
• IPv6 Motivation and Overview	455
• Major Changes And Additions In IPv6	458
• Transition from IPv4 to IPv6.....	459
• IPv6 Addressing	462
• IPv6 Addressing Overview: Addressing Model and Address Types	462
• IPv6 Address Size and Address Space.....	464
• IPv6 Address and Address Notation and Prefix Representation	466
• IPv6 Address Space Allocation	470
• IPv6 Global Unicast Address Format	473
• IPv6 Interface Identifiers and Physical Address Mapping	479
• IPv6 Special Addresses: Reserved, Private (Link-Local / Site-Local), Unspecified and Loopback	480
• IPv6/IPv4 Address Embedding	484
• IPv6 Multicast and Anycast Addressing	486
• IPv6 Autoconfiguration and Renumbering	492
• IPv6 Datagram Encapsulation and Formatting.....	495
• IPv6 Datagram Overview and General Structure	495
• IPv6 Datagram Main Header Format.....	497
• IPv6 Datagram Extension Headers.....	501
• IPv6 Datagram Options.....	507
• IPv6 Datagram Size, Maximum Transmission Unit (MTU), Fragmentation and Reassembly	511
• IPv6 Datagram Delivery and Routing	516
• IP Network Address Translation (NAT) Protocol	518
• IP NAT Overview, Motivation, Advantages and Disadvantages	518
• IP NAT Address Terminology.....	522
• IP NAT Static and Dynamic Address Mappings	525
• IP NAT Unidirectional (Traditional/Outbound) Operation.....	527
• IP NAT Bidirectional (Two-Way/Inbound) Operation	531
• IP NAT Port-Based ("Overloaded") Operation: Network Address Port Translation (NAPT) / Port Address Translation (PAT)	535
• IP NAT "Overlapping" / "Twice NAT" Operation	539
• IP NAT Compatibility Issues and Special Handling Requirements	542
• IP Security (IPSec) Protocols	545
• IPSec Overview, History and Standards	545
• IPSec General Operation, Components and Protocols	548
• IPSec Architectures and Implementation Methods.....	550
• IPSec Modes: Transport and Tunnel	553

• IPsec Security Associations and the Security Association Database (SAD); Security Policies and the Security Policy Database (SPD); Selectors; the Security Parameter Index (SPI)	557
• IPsec Authentication Header (AH).....	559
• IPsec Encapsulating Security Payload (ESP)	564
• IPsec Key Exchange (IKE).....	569
• Internet Protocol Mobility Support (Mobile IP)	572
• Mobile IP Overview, History and Motivation.....	572
• Mobile IP Concepts and General Operation	576
• Mobile IP Addressing: Home and "Care-Of" Addresses	580
• Mobile IP Agent Discovery, and Agent Advertisement and Solicitation Messages.....	583
• Mobile IP Home Agent Registration and Registration Messages	589
• Mobile IP Data Encapsulation and Tunneling.....	594
• Mobile IP and TCP/IP Address Resolution Protocol (ARP) Operation	597
• Mobile IP Efficiency Issues	600
• Mobile IP Security Considerations	602
• Internet Control Message Protocol (ICMP/ICMPv4 and ICMPv6)	604
• ICMP Concepts and General Operation.....	605
• ICMP Overview, History, Versions and Standards.....	605
• ICMP General Operation	607
• ICMP Message Classes, Types and Codes.....	610
• ICMP Message Creation and Processing Conventions and Rules.....	614
• ICMP Common Message Format and Data Encapsulation.....	616
• ICMP Message Types and Formats.....	619
• ICMP Version 4 (ICMPv4) Error Message Types and Formats	620
• ICMPv4 Destination Unreachable Messages	620
• ICMPv4 Source Quench Messages	624
• ICMPv4 Time Exceeded Messages.....	626
• ICMPv4 Redirect Messages.....	629
• ICMPv4 Parameter Problem Messages	633
• ICMP Version 4 (ICMPv4) Informational Message Types and Formats	636
• ICMPv4 Echo (Request) and Echo Reply Messages.....	636
• ICMPv4 Timestamp (Request) and Timestamp Reply Messages	638
• ICMPv4 Router Advertisement and Router Solicitation Messages	640
• ICMPv4 Address Mask Request and Reply Messages	644
• ICMPv4 Traceroute Messages	646
• ICMP Version 6 (ICMPv6) Error Message Types and Formats	649
• ICMPv6 Destination Unreachable Messages.....	649
• ICMPv6 Packet Too Big Messages	652
• ICMPv6 Time Exceeded Messages.....	654
• ICMPv6 Parameter Problem Messages	657
• ICMP Version 6 (ICMPv6) Informational Message Types and Formats	660
• ICMPv6 Echo Request and Echo Reply Messages	661
• ICMPv6 Router Advertisement and Router Solicitation Messages	662
• ICMPv6 Neighbor Advertisement and Neighbor Solicitation Messages.....	666
• ICMPv6 Redirect Messages.....	671
• ICMPv6 Router Renumbering Messages	673
• ICMPv6 Informational Message Options.....	677
• TCP/IP IPv6 Neighbor Discovery Protocol (ND)	683
• IPv6 ND Overview, History, Motivation and Standards.....	683

• IPv6 ND General Operational Overview: ND Functions, Functional Groups and Message Types.....	685
• IPv6 ND Functions Compared to Equivalent IPv4 Functions	688
• IPv6 ND Host-Router Discovery Functions: Router Discovery, Prefix Discovery, Parameter Discovery and Address Autoconfiguration	689
• IPv6 ND Host-Host Communication Functions: Address Resolution, Next-Hop Determination, Neighbor Unreachability Detection and Duplicate Address Detection	691
• IPv6 ND Redirect Function.....	693
• TCP/IP Routing Protocols (Gateway Protocols)	696
• Overview Of Key Routing Protocol Concepts: Architectures, Protocol Types, Algorithms and Metrics	698
• TCP/IP Interior Routing Protocols (RIP, OSPF, GGP, HELLO, IGRP, EIGRP).....	703
• TCP/IP Routing Information Protocol (RIP, RIP-2 and RIPng)	704
• RIP Fundamentals and General Operation	705
• RIP Overview, History, Standards and Versions	705
• RIP Route Determination Algorithm and Metric	707
• RIP General Operation, Messaging and Timers.....	711
• RIP Protocol Limitations and Problems	714
• RIP Special Features For Resolving RIP Algorithm Problems.....	718
• RIP Version-Specific Message Formats and Features	723
• RIP Version 1 (RIP-1) Message Format.....	723
• RIP Version 2 (RIP-2) Message Format and Features	726
• RIPng ("RIPv6") Message Format and Features.....	729
• Open Shortest Path First (OSPF).....	733
• OSPF Overview, History, Standards and Versions.....	733
• OSPF Basic Topology and the Link State Database (LSDB)	735
• OSPF Hierarchical Topology, Areas and Router Roles.....	738
• OSPF Route Determination Using SPF Trees	741
• OSPF General Operation and Message Types	745
• OSPF Message Formats	747
• Other Interior Routing Protocols	757
• TCP/IP Gateway-to-Gateway Protocol (GGP)	757
• The HELLO Protocol (HELLO)	759
• Interior Gateway Routing Protocol (IGRP).....	761
• Enhanced Interior Gateway Routing Protocol (EIGRP)	763
• TCP/IP Exterior Gateway/Routing Protocols (BGP and EGP)	765
• TCP/IP Border Gateway Protocol (BGP/BGP-4)	766
• BGP Fundamentals and General Operation	767
• BGP Overview, History, Standards and Versions	767
• BGP Topology, Speakers, Border Routers and Neighbor Relationships (Internal and External Peers).....	771
• BGP Autonomous System Types, Traffic Flows and Routing Policies.....	773
• BGP Route Storage and Advertisement, and BGP Routing Information Bases (RIBs).....	776
• BGP Path Attributes and Algorithm Overview.....	777
• BGP Route Determination and the BGP Decision Process	780
• BGP General Operation and Messaging.....	782
• BGP Detailed Messaging, Operation and Message Formats	785

• BGP Message Generation and Transport, and General Message Format.....	785
• BGP Connection Establishment: Open Messages	788
• BGP Route Information Exchange: Update Messages	791
• BGP Connectivity Maintenance: Keepalive Messages	796
• BGP Error Reporting: Notification Messages	798
• TCP/IP Exterior Gateway Protocol (EGP).....	802
• TCP/IP Transport Layer Protocols.....	805
• Transmission Control Protocol (TCP) and User Datagram Protocol (UDP).....	806
• TCP and UDP Overview and Role In TCP/IP.....	807
• TCP/IP Transport Layer Protocol (TCP and UDP) Addressing: Ports and Sockets	810
• TCP/IP Processes, Multiplexing and Client/Server Application Roles.....	810
• TCP/IP Ports: Transport Layer (TCP/UDP) Addressing	813
• TCP/IP Application Assignments and Server Port Number Ranges: Well-Known, Registered and Dynamic/Private Ports.....	816
• TCP/IP Client (Ephemeral) Ports and Client/Server Application Port Use.....	818
• TCP/IP Sockets and Socket Pairs: Process and Connection Identification ...	821
• Common TCP/IP Applications and Assigned Well-Known and Registered Port Numbers	823
• TCP/IP User Datagram Protocol (UDP).....	827
• UDP Overview, History and Standards	827
• UDP Operation.....	828
• UDP Message Format	830
• UDP Common Applications and Server Port Assignments	832
• TCP/IP Transmission Control Protocol (TCP).....	836
• TCP Overview, Functions and Characteristics.....	837
• TCP Overview, History and Standards.....	837
• TCP Functions: What TCP Does.....	840
• TCP Characteristics: How TCP Does What It Does	842
• TCP Fundamentals and General Operation	845
• TCP Data Handling and Processing: Streams, Segments and Sequence Numbers.....	845
• TCP Sliding Window Acknowledgment System For Data Transport, Reliability and Flow Control.....	849
• TCP Ports, Connections and Connection Identification	859
• TCP Common Applications and Server Port Assignments	861
• TCP Basic Operation: Connection Establishment, Management and Termination.....	864
• TCP Operational Overview and the TCP Finite State Machine (FSM)	864
• TCP Connection Preparation: Transmission Control Blocks (TCBs) and Passive and Active Socket OPENS.....	869
• TCP Connection Establishment Process: The "Three-Way Handshake"	871
• TCP Connection Establishment Sequence Number Synchronization and Parameter Exchange.....	876
• TCP Connection Management and Problem Handling, the Connection Reset Function, and TCP "Keepalives"	879
• TCP Connection Termination.....	882
• TCP Message Formatting and Data Transfer.....	889
• TCP Message (Segment) Format.....	889

• TCP Checksum Calculation and the TCP "Pseudo Header"	895
• TCP Maximum Segment Size (MSS) and Relationship to IP Datagram Size	898
• TCP Sliding Window Data Transfer and Acknowledgement Mechanics	901
• TCP Immediate Data Transfer: "Push" Function	912
• TCP Priority Data Transfer: "Urgent" Function	914
• TCP Reliability and Flow Control Features and Protocol Modifications	916
• TCP Segment Retransmission Timers and the Retransmission Queue	916
• TCP Non-Contiguous Acknowledgment Handling and Selective Acknowledgment (SACK)	919
• TCP Adaptive Retransmission and Retransmission Timer Calculations	925
• TCP Window Size Adjustment and Flow Control	928
• TCP Window Management Issues	932
• TCP "Silly Window Syndrome" and Changes To the Sliding Window System For Avoiding Small-Window Problems	936
• TCP Congestion Handling and Congestion Avoidance Algorithms	940
• Summary Comparison of TCP/IP Transport Layer Protocols (UDP and TCP)	945

TCP/IP Application Layer Protocols, Services and Applications (OSI Layers 5, 6 and 7) 946

• Name Systems and TCP/IP Name Registration and Name Resolution	947
• Name System Issues, Concepts and Techniques	948
• Name System Overview and Motivation	948
• Name System Functions: Name Space, Name Registration and Name Resolution	952
• Name Spaces and Name Architectures (Flat and Hierarchical)	954
• Name Registration Methods, Administration and Authorities	957
• Name Resolution Techniques and Functional Elements of A Name Resolution System	960
• Efficiency, Reliability and Other Name Resolution Issues and Features ..	962
• TCP/IP Name Systems: Host Tables and Domain Name System (DNS)	964
• Overview and History of TCP/IP Host Names and Name Systems	965
• TCP/IP Host Table Name System	967
• TCP/IP Domain Name System (DNS)	971
• DNS Overview, Functions and Characteristics	972
• DNS Overview, History and Standards	972
• DNS Design Goals, Objectives and Assumptions	975
• DNS Components and General Functions	977
• DNS Name Space, Architecture and Terminology	981
• DNS Domains and the DNS Hierarchical Name Architecture	981
• DNS Structural Elements and Terminology: Domains, Subdomains, and Nodes; Roots, Leaves and Branches; Parents, Children and Siblings	983
• DNS Labels, Names and Syntax Rules	987
• Absolute (Fully-Qualified) and Relative (Partially-Qualified) Domain Name Specifications	990
• DNS Name Registration, Public Administration, Zones and Authorities	992
• DNS Hierarchical Authority Structure and the Distributed Name Database	992
• DNS Organizational (Generic) Top Level Domains and Authorities	994

⦿	DNS Geopolitical (Country Code) Top Level Domains and Authorities	999
⦿	DNS Second-Level and Lower Domains, Delegation of Registration Authority and Public Registration	1002
⦿	DNS Public Registration Disputes (Conflicts, Cybersquatting, "Deceptive Naming", Etc.) and Dispute Resolution	1003
⦿	DNS Name Space Administrative Hierarchy Partitioning: DNS Zones of Authority	1007
⦿	DNS Private Name Registration	1010
⦿	DNS Name Servers and Name Resolution	1013
⦿	DNS Name Server Concepts and Operation	1014
⦿	DNS Name Server Functions, Name Server Architecture and General Operation	1014
⦿	DNS Name Server Data Storage: Resource Records and Classes	1017
⦿	DNS Name Server Types and Roles: Primary/Master, Secondary/Slave and Caching-Only Servers	1020
⦿	DNS Zone Management, Contacts and Zone Transfers	1023
⦿	DNS Root Name Servers	1026
⦿	DNS Name Server Caching, Negative Caching and Data Persistence	1028
⦿	DNS Name Server Load Balancing	1032
⦿	DNS Name Server Enhancements: DNS Notify, Incremental Zone Transfers, and DNS Update (Dynamic DNS)	1033
⦿	DNS Resolution Concepts and Resolver Operations	1037
⦿	DNS Resolver Functions and General Operation	1037
⦿	DNS Basic Name Resolution Techniques: Iterative and Recursive Resolution	1039
⦿	DNS Name Resolution Efficiency Improvements: Caching and Local Resolution	1043
⦿	DNS Name Resolution Process	1046
⦿	DNS Reverse Name Resolution Using the IN-ADDR.ARPA Domain	1049
⦿	DNS Electronic Mail Support and Mail Exchange (MX) Resource Records	1053
⦿	DNS Messaging and Message, Resource Record and Master File Formats	1056
⦿	DNS Message Generation and Transport	1056
⦿	DNS Message Processing and General Message Format	1058
⦿	DNS Message Header and Question Section Format	1061
⦿	DNS Message Resource Record Field Formats	1066
⦿	DNS Name Notation and Message Compression Technique	1071
⦿	DNS Master File Format	1074
⦿	DNS Changes To Support IP Version 6	1079
⦿	Network File and Resource Sharing Protocols and the TCP/IP Network File System (NFS)	1081
⦿	Overview of File and Resource Sharing Protocol Concepts and Operation	1082
⦿	TCP/IP Network File System (NFS)	1084
⦿	NFS Overview, History, Versions and Standards	1084
⦿	NFS Architecture and Components	1086
⦿	NFS Data Storage and Data Types, and the External Data Representation (XDR) Standard	1089
⦿	NFS Client/Server Operation Using Remote Procedure Calls (RPCs)	1091
⦿	NFS Server Procedures and Operations	1094
⦿	NFS File System Model and the Mount Protocol	1099

①	TCP/IP Network Configuration and Management Protocols (BOOTP, DHCP, SNMP and RMON)	1101
①	Host Configuration and TCP/IP Host Configuration Protocols (BOOTP and DHCP)	1102
②	Host Configuration Concepts, Issues and Motivation	1103
②	TCP/IP Bootstrap Protocol (BOOTP)	1106
③	BOOTP Overview, History and Standards	1106
③	BOOTP Client/Server Messaging and Addressing.....	1109
③	BOOTP Detailed Operation.....	1112
③	BOOTP Message Format	1115
③	BOOTP Vendor-Specific Area and Vendor Information Extensions	1119
③	BOOTP Relay Agents (Forwarding Agents).....	1122
②	TCP/IP Dynamic Host Configuration Protocol (DHCP)	1127
③	DHCP Overview, Motivation, History and Standards.....	1128
③	DHCP Address Assignment and Dynamic Address Allocation and Management	1131
④	DHCP Address Assignment and Allocation Mechanisms.....	1131
④	DHCP Leases, Lease Length Policies and Management.....	1134
④	DHCP Lease "Life Cycle" Overview (Allocation, Reallocation, Renewal, Rebinding and Release) and Lease Timers	1137
④	DHCP Lease Address Pools, Ranges (Scopes) and Address Management.....	1140
②	DHCP Configuration and Operation	1144
④	DHCP Overview of Client and Server Responsibilities	1144
④	DHCP Configuration Parameters, Storage and Communication	1146
④	DHCP General Operation and Client Finite State Machine	1148
④	DHCP Lease Allocation Process	1151
④	DHCP Lease Reallocation Process	1158
④	DHCP Lease Renewal and Rebinding Processes	1161
④	DHCP Early Lease Termination (Release) Process	1165
④	DHCP Parameter Configuration Process For Clients With Non-DHCP Addresses.....	1166
②	DHCP Messaging, Message Types and Formats	1169
④	DHCP Message Generation, Addressing, Transport and Retransmission.....	1169
④	DHCP Message Format.....	1172
④	DHCP Options, Option Format and "Option Overloading"	1175
④	Summary Of DHCP Options / BOOTP Vendor Information Fields.....	1181
②	DHCP Client/Server Implementation, Features and Issues	1190
④	DHCP Server General Implementation and Management Issues	1190
④	DHCP Client General Implementation and Management Issues	1192
④	DHCP Message Relaying and BOOTP Relay Agents.....	1193
④	DHCP Autoconfiguration / Automatic Private IP Addressing (APIPA).....	1195
④	DHCP Server Conflict Detection	1198
④	DHCP and BOOTP Interoperability	1199
④	DHCP Security Issues.....	1201
②	DHCP For IP Version 6 (DHCPv6)	1203
①	TCP/IP Network Management Framework and Protocols (SNMP and RMON)	1205
②	TCP/IP Internet Standard Management Framework Overview, Architecture, Components and Concepts	1206
③	Overview and History of the TCP/IP Internet Standard Management Framework and Simple Network Management Protocol (SNMP)	1206

❶	TCP/IP SNMP Operational Model, Components and Terminology	1209
❷	TCP/IP Internet Standard Management Framework Architecture and Protocol Components	1212
❸	TCP/IP Internet Standard Management Framework and SNMP Versions (SNMPv1, SNMPv2 Variants, SNMPv3)	1214
❹	TCP/IP Internet Standard Management Framework and SNMP Standards	1217
❶	TCP/IP Structure of Management Information (SMI) and Management Information Bases (MIBs)	1222
❶	TCP/IP Structure of Management Information (SMI) and Management Information Bases (MIBs) Overview	1222
❷	TCP/IP MIB Objects, Object Characteristics and Object Types	1226
❸	TCP/IP MIB Object Descriptors and Identifiers and the Object Name Hierarchy and Name Notation	1230
❹	TCP/IP MIB Modules and Object Groups	1234
❷	TCP/IP Simple Network Management Protocol (SNMP) Protocol	1239
❶	SNMP Protocol Overview, History and General Concepts	1240
❷	SNMP Protocol Operations	1242
❶	SNMP Protocol General Operation, Communication Methods and Message Classes	1242
❷	SNMP Protocol Basic Request/Response Information Poll Using GetRequest and (Get)Response Messages	1245
❸	SNMP Protocol Table Traversal Using GetNextRequest and GetBulkRequest Messages	1246
❹	SNMP Protocol Object Modification Using SetRequest Messages	1248
❺	SNMP Protocol Information Notification Using Trap(v2) and InformRequest Messages	1250
❻	SNMP Protocol Security Issues and Methods	1252
❸	SNMP Protocol Messaging and Message Formats	1255
❶	SNMP Protocol Message Generation, Addressing, Transport and Retransmission	1255
❷	SNMP Message Field Definitions, General Message Format and Message Sections	1257
❸	SNMP Version 1 (SNMPv1) Message Format	1261
❹	SNMP Version 2 (SNMPv2) Message Formats	1265
❺	SNMP Version 3 (SNMPv3) Message Format	1274
❹	TCP/IP Remote Network Monitoring (RMON)	1279
❸	TCP/IP Key Applications and Application Protocols	1283
❶	TCP/IP Application Layer Addressing: Uniform Resource Identifiers, Locators and Names (URIs, URLs and URNs)	1284
❶	Uniform Resource Identifiers, Locators and Names (URIs, URLs and URNs): Overview, History, Significance and Standards	1285
❷	Uniform Resource Locators (URLs)	1288
❶	URL General Syntax	1288
❷	URL Schemes (Applications / Access Methods) and Scheme-Specific Syntaxes	1292
❸	URL Relative Syntax and Base URLs	1296
❹	URL Length and Complexity Issues	1300
❺	URL Obscuration, Obfuscation and General Trickery	1303
❸	Uniform Resource Names (URNs)	1308

❶	TCP/IP File and Message Transfer Applications and Protocols (FTP, TFTP, Electronic Mail, USENET, HTTP/WWW, Gopher)	1312
❷	File and Message Transfer Overview and Application Categories	1313
❸	TCP/IP General File Transfer Protocols (FTP and TFTP)	1315
❶	File Transfer Protocol (FTP)	1316
❶	FTP Overview, History and Standards	1317
❷	FTP Concepts and General Operation	1319
❶	FTP Operational Model, Protocol Components and Key Terminology	1319
❷	FTP Control Connection Establishment, User Authentication and Anonymous FTP Access.....	1323
❸	FTP Data Connection Management, Normal (Active) and Passive Data Connections and Port Usage.....	1326
❹	FTP General Data Communication and Transmission Modes	1330
❺	FTP Data Representation: Data Types, Data Structures and Format Control	1331
❸	FTP Commands and Replies.....	1335
❶	FTP Internal Protocol Commands and Command Groups	1335
❷	FTP Replies, Reply Code Format and Important Reply Codes	1339
❸	FTP User Interface and User Commands	1344
❹	FTP Sample User and Internal Command Dialog.....	1348
❷	Trivial File Transfer Protocol (TFTP)	1351
❶	TFTP Overview, History and Standards	1351
❷	TFTP General Operation, Connection Establishment and Client/Server Communication	1354
❸	TFTP Detailed Operation and Messaging	1356
❹	TFTP Options and Option Negotiation	1359
❺	TFTP Message Formats.....	1363
❹	TCP/IP Electronic Mail System: Concepts and Protocols (RFC 822, MIME, SMTP, POP3, IMAP)	1369
❶	TCP/IP Electronic Mail System Overview and Concepts	1370
❶	TCP/IP Electronic Mail System Overview and History.....	1370
❷	TCP/IP Electronic Mail Communication Overview: Message Composition, Submission, Delivery, Receipt, Processing and Access	1372
❸	TCP/IP Electronic Mail Message Communication Model and Device and Protocol Roles	1375
❷	TCP/IP Electronic Mail Addresses and Addressing.....	1379
❶	TCP/IP Electronic Mail Addressing and Address Resolution	1379
❷	TCP/IP Historical and Special Electronic Mail Addressing	1382
❸	TCP/IP Electronic Mail Aliases / Address Books, Multiple Recipient Addressing and Electronic Mailing Lists.....	1384
❸	TCP/IP Electronic Mail Message Formats and Message Processing: RFC 822 and MIME	1387
❶	TCP/IP Electronic Mail Standard Message Format: RFC 822.....	1388
❶	TCP/IP Electronic Mail RFC 822 Standard Message Format Overview, Structure and General Formatting Rules	1388
❷	TCP/IP Electronic Mail RFC 822 Standard Message Format Header Field Definitions and Groups.....	1391
❸	TCP/IP Electronic Mail RFC 822 Standard Message Format Processing and Interpretation.....	1395
❷	TCP/IP Enhanced Electronic Mail Message Format: Multipurpose Internet Mail Extensions (MIME)	1398
❶	MIME Message Format Overview, Motivation, History and Standards.....	1398
❷	MIME Basic Structures and Headers	1401

⦿	MIME Content-Type Header and Discrete Media: Types, Subtypes and Parameters.....	1405
⦿	MIME Composite Media Types: Multipart and Encapsulated Message Structures.....	1411
⦿	MIME Content-Transfer-Encoding Header and Encoding Methods.....	1416
⦿	MIME Extension for Non-ASCII Mail Message Headers	1420
⦿	TCP/IP Electronic Mail Delivery Protocol: The Simple Mail Transfer Protocol (SMTP)	1422
⦿	SMTP Overview, History and Standards	1422
⦿	SMTP Communication and Message Transport Methods, Client/Server Roles and Terminology	1424
⦿	SMTP Connection and Session Establishment and Termination.....	1426
⦿	SMTP Mail Transaction Process	1430
⦿	SMTP Special Features, Capabilities and Extensions	1434
⦿	SMTP Security Issues.....	1436
⦿	SMTP Commands.....	1439
⦿	SMTP Replies and Reply Codes	1441
⦿	TCP/IP Electronic Mail Access and Retrieval Protocols and Methods	1446
⦿	TCP/IP Electronic Mail Mailbox Access Model, Method and Protocol Overview	1447
⦿	TCP/IP Post Office Protocol (POP/POP3)	1450
⦿	POP Overview, History, Versions and Standards.....	1450
⦿	POP3 General Operation, Client/Server Communication and Session States	1452
⦿	POP3 Authorization State: User Authentication Process and Commands	1453
⦿	POP3 Transaction State: Mail and Information Exchange Process and Commands.....	1456
⦿	POP3 Update State: Mailbox Update and Session Termination Process and Commands.....	1461
⦿	TCP/IP Internet Message Access Protocol (IMAP/IMAP4).....	1463
⦿	IMAP Overview, History, Versions and Standards	1463
⦿	IMAP General Operation, Client/Server Communication and Session States	1466
⦿	IMAP Commands, Results and Responses.....	1469
⦿	IMAP Not Authenticated State: User Authentication Process and Commands	1472
⦿	IMAP Authenticated State: Mailbox Manipulation/Selection Process and Commands.....	1474
⦿	IMAP Selected State: Message Manipulation Process and Commands.....	1476
⦿	Other TCP/IP Electronic Mail Access and Retrieval Methods.....	1479
⦿	TCP/IP Direct Server Electronic Mail Access.....	1479
⦿	TCP/IP World Wide Web Electronic Mail Access.....	1481
⦿	Usenet (Network News) and the TCP/IP Network News Transfer Protocol (NNTP).....	1483
⦿	Usenet Overview, Concepts and General Operation	1484
⦿	Usenet Overview, History and Standards	1484
⦿	Usenet Communication Model: Message Composition, Posting, Storage, Propagation and Access	1487
⦿	Usenet Addressing: Newsgroups, Newsgroup Hierarchies and Types.....	1490
⦿	Usenet Message Format and Special Headers.....	1494
⦿	TCP/IP Network News Transfer Protocol (NNTP).....	1499
⦿	NNTP Overview and General Operation.....	1499
⦿	NNTP Inter-Server Communication Process: News Article Propagation	1501

⦿ NNTP Client-Server Communication Process: News Posting and Access	1505
⦿ NNTP Commands	1509
⦿ NNTP Command Extensions.....	1512
⦿ NNTP Status Responses and Response Codes.....	1517
⦿ TCP/IP World Wide Web (WWW, "The Web") and the Hypertext Transfer Protocol (HTTP)	1522
⦿ TCP/IP World Wide Web and Hypertext Overview and Concepts.....	1523
⦿ World Wide Web and Hypertext Overview and History	1523
⦿ World Wide Web System Concepts and Components	1525
⦿ World Wide Web Media and the Hypertext Markup Language (HTML)	1528
⦿ World Wide Web Addressing: HTTP Uniform Resource Locators (URLs)	1533
⦿ TCP/IP Hypertext Transfer Protocol (HTTP)	1536
⦿ HTTP Overview, History, Versions and Standards	1537
⦿ HTTP General Operation and Connections	1540
⦿ HTTP Operational Model and Client/Server Communication	1540
⦿ HTTP Transitory and Persistent Connections and Pipelining.....	1543
⦿ HTTP Persistent Connection Establishment, Management and Termination	1545
⦿ HTTP Messages, Message Formats, Methods and Status Codes	1548
⦿ HTTP Generic Message Format.....	1548
⦿ HTTP Request Message Format.....	1550
⦿ HTTP Response Message Format.....	1553
⦿ HTTP Methods.....	1555
⦿ HTTP Status Code Format, Status Codes and Reason Phrases.....	1559
⦿ HTTP Message Headers	1565
⦿ HTTP General Headers.....	1565
⦿ HTTP Request Headers	1569
⦿ HTTP Response Headers	1573
⦿ HTTP Entity Headers	1575
⦿ HTTP Entities, Transfers, Coding Methods and Content Management	1578
⦿ HTTP Entities and Internet Media Types	1578
⦿ HTTP Data Transfer, Content Encodings and Transfer Encodings	1580
⦿ HTTP Data Length Issues, "Chunked" Transfers and Message Trailers.....	1583
⦿ HTTP Content Negotiation and "Quality Values"	1587
⦿ HTTP Features, Capabilities and Issues	1590
⦿ HTTP Caching Features and Issues.....	1590
⦿ HTTP Proxy Servers and Proxying	1594
⦿ HTTP Security and Privacy	1597
⦿ HTTP State Management Using "Cookies"	1599
⦿ Gopher Protocol (Gopher)	1603
⦿ TCP/IP Interactive and Remote Application Protocols	1607
⦿ Telnet Protocol.....	1608
⦿ Telnet Overview, History and Standards	1608
⦿ Telnet Connections and Client/Server Operation	1611
⦿ Telnet Communications Model and the Network Virtual Terminal (NVT)	1613
⦿ Telnet Protocol Commands.....	1617
⦿ Telnet Interrupt Handling Using Out-Of-Band Signaling: The Telnet Synch Function	1620
⦿ Telnet Options and Option Negotiation	1622
⦿ Berkeley Remote ("r") Commands.....	1628
⦿ Berkeley Remote Login (rlogin).....	1628
⦿ Berkeley Remote Shell (rsh).....	1630
⦿ Other Berkeley Remote ("r") Commands (rcp, ruptime, rwho).....	1631

• Internet Relay Chat Protocol (IRC).....	1633
• TCP/IP Administration and Troubleshooting Utilities and Protocols.	1636
• TCP/IP Host Name Utility (hostname).....	1637
• TCP/IP Communication Verification Utility (ping/ping6).....	1638
• TCP/IP Route Tracing Utility (tracert/traceroute6)	1643
• TCP/IP Address Resolution Protocol Utility (arp).....	1648
• TCP/IP DNS Name Resolution and Information Lookup Utilities (nslookup, host and dig)	1649
• TCP/IP DNS Registry Database Lookup Utility (whois/nicname)	1655
• TCP/IP Network Status Utility (netstat).....	1657
• TCP/IP Configuration Utilities (ipconfig, winipcfg and ifconfig)	1664
• Miscellaneous TCP/IP Troubleshooting Protocols: Echo, Discard, Character Generator, Quote Of The Day, Active Users, Daytime, Time	1670

List of Figures

Figure 2: Packet Switching	67
Figure 1: Circuit Switching	67
Figure 3: Network Message Formatting.....	74
Figure 4: Unicast, Multicast and Broadcast Message Addressing and Transmission.....	76
Figure 5: Peer-to-Peer Networking.....	78
Figure 6: Client/Server Networking	79
Figure 7: Internet Standards Organizations	111
Figure 8: Binary Information Representations and Terms	122
Figure 9: Binary, Octal and Hexadecimal Number Representations	125
Figure 10: Clearing Bits Using an <i>AND</i> Bit Mask.....	137
Figure 11: OSI Reference Model Layers	150
Figure 12: OSI Reference Model Layer Relationships and Terminology.....	152
Figure 13: OSI Reference Model Interfaces for Vertical Communication.....	155
Figure 14: OSI Reference Model Protocols: Horizontal Communication	158
Figure 15: OSI Reference Model Data Encapsulation	159
Figure 16: OSI Reference Model PDU and SDU Encapsulation.....	161
Figure 17: Message Routing in the OSI Reference Model	164
Figure 18: OSI Reference Model Mnemonics	182
Figure 19: TCP/IP Client/Server Operation.....	192
Figure 20: OSI Reference Model and TCP/IP Model Layers.....	195
Figure 21: TCP/IP Protocols.....	198
Figure 22: Operation of the Serial Line Internet Protocol (SLIP).....	211
Figure 23: PPP Location in TCP/IP Architecture.....	216
Figure 24: Overview of PPP Operation	219
Figure 25: PPP Phases	221
Figure 26: PPP Link Control Protocol (LCP) Message Exchanges	229
Figure 27: PPP LCP Link Configuration Process	231
Figure 28: PPP IP Control Protocol (IPCP) Message Exchanges.....	235
Figure 29: PPP Password Authentication Protocol (PAP) Authentication.....	237
Figure 30: PPP Challenge Handshake Authentication Protocol (CHAP) Authentication	238
Figure 31: Multilink PPP Architecture.....	249
Figure 32: PPP General Frame Format	256
Figure 33: Sample PPP Data Frame	256
Figure 34: PPP Control Message Format	261
Figure 35: PPP Control Message Carrying Options	263
Figure 36: PPP Control Message Option Format.....	264
Figure 37: PPP PAP Authenticate-Request Frame Format.....	269
Figure 38: PPP PAP Authenticate-Ack and Authenticate-Nak Frame Format.....	269
Figure 39: PPP CHAP Challenge and Response Frame Format.....	271
Figure 40: PPP CHAP Success and Failure Frame Format.....	271
Figure 41: PPP Multilink Protocol Long Fragment Frame Format	273
Figure 42: PPP Multilink Protocol Short Fragment Frame Format.....	274

Figure 43: PPP Multilink Protocol (MP) Fragmentation Demonstration	276
Figure 44: Why Address Resolution Is Necessary	281
Figure 45: Address Resolution Through Direct Mapping	283
Figure 46: Address Resolution Problems With Large Hardware Address Size	284
Figure 47: Dynamic Address Resolution.....	286
Figure 48: Address Resolution Protocol (ARP) Transaction Process.....	292
Figure 49: Address Resolution Protocol (ARP) Message Format.....	296
Figure 50: ARP Proxy Operation	300
Figure 51: Mapping of Multicast IP Addresses to IEEE 802 Multicast MAC Addresses	302
Figure 52: Operation of the Reverse Address Resolution Protocol (RARP).....	306
Figure 53: Reverse Address Resolution Protocol (RARP) Operation.....	307
Figure 54: The Main Function of IP: Internetwork Datagram Delivery.....	312
Figure 55: IP Interfaces for Common Network Devices	321
Figure 56: IP Address Binary, Hexadecimal and Dotted Decimal Representations	324
Figure 57: Basic IP Address Division: Network ID and Host ID	326
Figure 58: Mid-Octet IP Address Division	327
Figure 59: Multihomed Devices On An IP Internetwork	331
Figure 60: Division of IPv4 Address Space Into Classes.....	336
Figure 61: Class Determination Algorithm for “Classful” IP Addresses.....	338
Figure 62: IP Address Class Bit Assignments and Network/Host ID Sizes.....	341
Figure 63: IP Multicast Address Ranges and Uses	350
Figure 64: The Main Problem With “Classful” Addressing.....	353
Figure 65: Subnetting A Class B Network.....	358
Figure 66: Determining the Subnet Mask of a Subnetted Network.....	361
Figure 67: Determining the Subnet ID of an IP Address Through Subnet Masking.....	362
Figure 68: Default Subnet Masks for Class A, Class B and Class C Networks	365
Figure 69: Custom Subnet Masks for Class C Networks	369
Figure 70: Class C (/24) Network Split Into Eight Conventional Subnets.....	378
Figure 71: Class C (/24) Network Split Using Variable Length Subnet Masking (VLSM).....	379
Figure 72: Variable Length Subnet Masking (VLSM) Example	381
Figure 73: Subnetting Design Trade-Off For Class C Networks.....	385
Figure 74: Example Class C Subnetting: An “Easy Decision”	386
Figure 75: Example Class B Subnetting: A More Difficult Decision	387
Figure 76: Determining The Custom Subnet Mask for A Class C Network	389
Figure 77: Determining The Custom Subnet Mask for A Class B Network	390
Figure 78: Determining Subnet Addresses For A Class C Network	393
Figure 79: Determining Subnet Addresses For A Class B Network	395
Figure 80: Determining Host Addresses For A Class C Network.....	399
Figure 81: Classless Addressing (CIDR) Solves The “Granularity Problem”	405
Figure 82: CIDR (“Slash”) Notation and Its Subnet Mask Equivalent.....	407
Figure 83: Example Hierarchical Division Of A /15 CIDR Address Block.....	412
Figure 84: Hierarchical Address Division Using Classless Addressing (CIDR)	413
Figure 85: IP Datagram Encapsulation	418

Figure 86: Internet Protocol Version 4 (IPv4) Datagram Format	423
Figure 87: Internet Protocol Version 4 (IPv4) Option Format	427
Figure 88: IP Maximum Transmission Unit (MTU) and Fragmentation.....	432
Figure 89: IPv4 Datagram Fragmentation.....	433
Figure 90: IPv4 Datagram Fragmentation Process.....	436
Figure 91: Direct and Indirect (Routed) Delivery of IP Datagrams	442
Figure 92: IP Datagram Next-Hop Routing	446
Figure 93: IP Routing and Routing Tables	448
Figure 94: A (Poor) Representation of Relative IPv4 and IPv6 Address Space Sizes	465
Figure 95: Binary, Decimal and Hexadecimal Representations of IPv6 Addresses	467
Figure 96: IPv6 Global Unicast Address Format.....	474
Figure 97: Example IPv6 Unicast Routing Prefix Structure	478
Figure 98: Converting IEEE 802 MAC Addresses To IPv6 Modified EUI-64 Identifiers	481
Figure 99: IPv4-Compatible Embedded IPv6 Address Representation	485
Figure 100: IPv4-Mapped Embedded IPv6 Address Representation	485
Figure 101: IPv6 Multicast Address Format	488
Figure 102: IPv6 Multicast Scope	489
Figure 103: IPv6 Solicited Node Address Calculation.....	490
Figure 104: IPv6 General Datagram Structure	497
Figure 105: IPv6 Main Header Format.....	499
Figure 106: IPv6 Extension Header Linking Using the <i>Next Header</i> Field	502
Figure 107: IPv6 <i>Routing</i> Extension Header Format	505
Figure 108: IPv6 <i>Fragment</i> Extension Header Format	506
Figure 109: IPv6 <i>Hop-By-Hop Options</i> and <i>Destination Options</i> Header Formats	509
Figure 110: IPv6 Datagram Fragmentation.....	515
Figure 111: IP Network Address Translation (NAT) Terminology	526
Figure 112: Operation Of Unidirectional (Traditional/Outbound) NAT	530
Figure 113: Operation Of Bidirectional (Two-Way/Inbound) NAT	534
Figure 114: Operation Of Port-Based (“Overloaded”) NAT	538
Figure 115: Operation Of “Overlapping” NAT / “Twice NAT”	542
Figure 116: Overview of IPSec Protocols and Components.....	549
Figure 117: IPSec “Bump In The Stack” (BITS) Architecture	552
Figure 118: IPSec “Bump In The Wire” (BITW) Architecture	553
Figure 119: IPSec Transport Mode Operation.....	554
Figure 120: IPSec Tunnel Mode Operation.....	556
Figure 121: IPv6 Datagram Format With IPSec Authentication Header (AH)	561
Figure 122: IPv4 Datagram Format With IPSec Authentication Header (AH)	562
Figure 123: IPSec Authentication Header (AH) Format.....	563
Figure 124: IPv6 Datagram Format With IPSec Encapsulating Security Payload (ESP).....	566
Figure 125: IPv4 Datagram Format With IPSec Encapsulating Security Payload (ESP).....	567
Figure 126: IPSec Encapsulating Security Payload (ESP) Format.....	569

Figure 127: The Main Problem With Mobile Devices on IP Internetworks.....	574
Figure 128: General Operation of the Mobile IP Protocol	578
Figure 129: Mobile IP Operation With A Foreign Agent “Care-Of” Address	582
Figure 130: Mobile IP <i>Mobility Agent Advertisement Extension</i> Format.....	587
Figure 131: Mobile IP <i>Prefix-Lengths Extension</i> Format	588
Figure 132: Mobile IP <i>Registration Request</i> Message Format	591
Figure 133: Mobile IP <i>Registration Reply</i> Message Format.....	594
Figure 134: Mobile IP Encapsulation and Tunneling.....	596
Figure 135: ARP Proxying By Mobile IP Home Agent	599
Figure 136: A Mobile IP Inefficiency “Worst Case Scenario”	601
Figure 137: ICMP General Operation	609
Figure 138: ICMP Common Message Format.....	617
Figure 139: ICMPv4 <i>Destination Unreachable</i> Message Format	621
Figure 140: ICMPv4 <i>Source Quench</i> Message Format.....	625
Figure 141: Expiration of an IP Datagram and <i>Time Exceeded</i> Message Generation	627
Figure 142: ICMPv4 <i>Time Exceeded</i> Message Format	628
Figure 143: Host Redirection Using an ICMP <i>Redirect</i> Message	630
Figure 144: ICMPv4 <i>Redirect</i> Message Format.....	631
Figure 145: ICMPv4 <i>Parameter Problem</i> Message Format	634
Figure 146: ICMPv4 <i>Echo</i> and <i>Echo Reply</i> Message Format.....	637
Figure 147: ICMPv4 <i>Timestamp</i> and <i>Timestamp Reply</i> Message Format	640
Figure 148: ICMPv4 <i>Router Advertisement</i> Message Format.....	642
Figure 149: ICMPv4 <i>Router Solicitation</i> Message Format	643
Figure 150: ICMPv4 <i>Address Mask Request</i> and <i>Address Mask Reply</i> Message Format.....	645
Figure 151: ICMPv4 <i>Traceroute</i> Message Format.....	647
Figure 152: ICMPv6 <i>Destination Unreachable</i> Message Format	650
Figure 153: ICMPv6 <i>Packet Too Big</i> Message Format	653
Figure 154: An Example of A Router Loop.....	655
Figure 155: ICMPv6 <i>Time Exceeded</i> Message Format	656
Figure 156: ICMPv6 <i>Parameter Problem</i> Message Format	658
Figure 157: ICMPv6 <i>Echo Request</i> and <i>Echo Reply</i> Message Format	662
Figure 158: ICMPv6 <i>Router Advertisement</i> Message Format.....	665
Figure 159: ICMPv6 <i>Router Solicitation</i> Message Format	666
Figure 160: ICMPv6 <i>Neighbor Advertisement</i> Message Format.....	669
Figure 161: ICMPv6 <i>Neighbor Solicitation</i> Message Format	670
Figure 162: ICMPv6 <i>Redirect</i> Message Format	673
Figure 163: ICMPv6 <i>Router Renumbering</i> Message Format.....	676
Figure 165: ICMPv6 <i>Target Link-Layer Address</i> Option Format	678
Figure 164: ICMPv6 <i>Source Link-Layer Address</i> Option Format	678
Figure 166: ICMPv6 <i>Prefix Information</i> Option Format	680
Figure 167: ICMPv6 <i>Redirected Header</i> Option Format	681
Figure 168: ICMPv6 <i>MTU</i> Option Format	682
Figure 169: Neighbor Discovery Protocol (ND) Functional Groups and Functions	686
Figure 170: ND Host Redirection Using an ICMPv6 <i>Redirect</i> Message	694

Figure 171: TCP/IP Autonomous System (AS) Routing Architecture	700
Figure 172: Example RIP Autonomous System	709
Figure 173: Propagation of Network Routing Information Using RIP	710
Figure 174: The RIP “Counting To Infinity” Problem	716
Figure 175: RIP Problem Solving Using Split Horizon With Poisoned Reverse	720
Figure 176: RIP Version 1 (RIP-1) Message Format.....	725
Figure 177: RIP Version 2 (RIP-2) Message Format.....	729
Figure 178: RIPng Message Format.....	732
Figure 179: Example OSPF Autonomous System	736
Figure 180: Example OSPF Hierarchical Topology Autonomous System	740
Figure 181: Example OSPF Autonomous System With Costs	743
Figure 182: OSPF Route Determination Using The Shortest Path First Algorithm	744
Figure 183: OSPF Calculated Shortest Path First Tree	745
Figure 184: OSPF Common Header Format	749
Figure 185: OSPF <i>Hello</i> Message Format.....	750
Figure 186: OSPF <i>Database Description</i> Message Format.....	752
Figure 187: OSPF <i>Link State Request</i> Message Format	753
Figure 189: OSPF <i>Link State Acknowledgment</i> Message Format.....	754
Figure 188: OSPF <i>Link State Update</i> Message Format	754
Figure 190: OSPF <i>Link State Advertisement</i> Header Format	756
Figure 191: BGP Example Topology and Designations	773
Figure 192: BGP General Message Format	787
Figure 193: BGP <i>Open</i> Message Format	790
Figure 194: BGP <i>Update</i> Message Format	795
Figure 195: BGP <i>Keepalive</i> Message Format.....	797
Figure 196: BGP <i>Notification</i> Message Format.....	799
Figure 197: Process Multiplexing and Demultiplexing In TCP/IP	812
Figure 198: TCP/IP Process Multiplexing/Demultiplexing Using TCP/UDP Ports	815
Figure 199: TCP/IP Client/Server Application Port Mechanics.....	821
Figure 201: UDP Pseudo Header Format.....	831
Figure 200: UDP Message Format.....	831
Figure 202: TCP Data Stream Processing and Segment Packaging.....	847
Figure 203: Operation Of An Unreliable Protocol	850
Figure 204: Basic Reliability: Positive Acknowledgment With Retransmission (PAR)	851
Figure 205: Enhanced Positive Acknowledgment With Retransmission (PAR)	853
Figure 206: Conceptual Division of TCP Transmission Stream Into Categories....	855
Figure 207: TCP Transmission Stream Categories and Send Window Terminology.....	856
Figure 208: TCP Stream Categories and Window After Sending Usable Window Bytes.....	857
Figure 209: Sliding The TCP Send Window.....	858
Figure 210: The TCP Finite State Machine (FSM)	868
Figure 211: TCP “Three-Way Handshake” Connection Establishment	

Procedure	874
Figure 212: TCP Simultaneous Open Connection Establishment Procedure.....	875
Figure 213: TCP Sequence Number Synchronization	878
Figure 214: TCP Connection Termination Procedure	885
Figure 215: TCP Simultaneous Connection Termination Procedure.....	888
Figure 216: TCP Segment Format	893
Figure 217: TCP “Pseudo Header” For Checksum Calculation	896
Figure 218: TCP Header Checksum Calculation.....	897
Figure 219: TCP Transmission Categories, Send Window and Pointers	903
Figure 220: TCP Receive Categories and Pointers.....	904
Figure 221: TCP Transaction Example Showing Server’s Send Pointers	910
Figure 222: TCP Transaction Example Showing Client’s Send Pointers	911
Figure 223: TCP Transaction Example With Retransmission.....	920
Figure 224: TCP “Aggressive” Retransmission Example.....	924
Figure 225: TCP Retransmission With Selective Acknowledgment (SACK).....	926
Figure 226: TCP Window Size Adjustments and Flow Control	931
Figure 227: The Problem With “Shrinking” The TCP Window.....	934
Figure 228: TCP “Silly Window Syndrome”	938
Figure 229: Internetwork Access Without A Name System	950
Figure 230: Internetwork Access With A Name System.....	951
Figure 231: Name System Functions	953
Figure 232: Flat Name Architecture (Flat Name Space)	955
Figure 233: Hierarchical Name Architecture (Structured Name Space)	956
Figure 234: DNS Functions	978
Figure 235: Example of a Global Hierarchical Domain Architecture	982
Figure 236: DNS Name Space Tree and Domain-Related Terminology.....	985
Figure 237: DNS Name Space “Family Tree”	986
Figure 238: DNS Labels and Domain Name Construction	989
Figure 239: Internet DNS Organizational (Generic) Top-Level Domains (TLDs).....	998
Figure 240: DNS Zones Of Authority.....	1009
Figure 241: DNS Resource Record Master File and Binary Field Formats	1018
Figure 242: Geographic Locations of Internet DNS Root Name Servers	1029
Figure 243: Iterative DNS Name Resolution	1041
Figure 244: Recursive DNS Name Resolution.....	1042
Figure 245: Example Of The DNS Name Resolution Process.....	1048
Figure 246: The DNS <i>IN-ADDR.ARPA</i> Reverse Name Resolution Hierarchy	1051
Figure 247: DNS General Message Format	1059
Figure 248: DNS Message Header Format.....	1064
Figure 249: DNS Message <i>Question</i> Section Format	1065
Figure 250: DNS Common Resource Record Format.....	1067
Figure 251: DNS <i>Start Of Authority</i> Resource Record Data Format	1070
Figure 252: DNS Standard Name Notation	1072
Figure 253: NFS Architectural Components	1088
Figure 254: General Operation Of the Boot Protocol	1111
Figure 255: Boot Protocol Operation	1113
Figure 256: BOOTP Message Format.....	1118

Figure 257: BOOTP Vendor-Specific Area Format Showing Vendor Information Fields	1120
Figure 258: BOOTP Operation Using A Relay Agent.....	1124
Figure 259: DHCP “Life Cycle” Example	1139
Figure 260: DHCP Scope.....	1141
Figure 261: DHCP Multi-Server Non-Overlapping Scopes.....	1142
Figure 262: DHCP Client Finite State Machine.....	1152
Figure 263: DHCP Lease Allocation Process	1154
Figure 264: DHCP Lease Reallocation Process	1159
Figure 265: DHCP Lease Renewal and Rebinding Processes.....	1163
Figure 266: DHCP Parameter Configuration Process	1167
Figure 267: DHCP Message Format	1176
Figure 268: DHCP <i>Options</i> Field Format	1178
Figure 269: DHCP Automatic Private IP Addressing (APIPA)	1197
Figure 270: SNMP Operational Model	1211
Figure 271: Components of the TCP/IP Internet Standard Management Framework	1213
Figure 272: SNMP Management Information Base (MIB)	1227
Figure 273: Global Object Name Hierarchy and SNMP MIB Hierarchies	1233
Figure 274: SNMP Information Poll Process	1246
Figure 275: SNMP Object Modification Process	1249
Figure 276: SNMP General Message Format.....	1260
Figure 277: SNMP Version 1 (SNMPv1) General Message Format.....	1262
Figure 278: SNMP Version 1 (SNMPv1) Common PDU Format.....	1264
Figure 279: SNMP Version 1 (SNMPv1) <i>Trap-PDU</i> Format.....	1265
Figure 280: SNMP Version 2 (SNMPv2p) General Message Format	1267
Figure 281: Community-Based SNMP Version 2 (SNMPv2c) General Message Format.....	1268
Figure 282: User-Based SNMP Version 2 (SNMPv2u) General Message Format	1270
Figure 283: SNMP Version 2 (SNMPv2) Common PDU Format.....	1273
Figure 284: SNMP Version 2 (SNMPv2) <i>GetBulkRequest-PDU</i> Format	1274
Figure 285: SNMP Version 3 (SNMPv3) General Message Format.....	1276
Figure 286: SNMP Remote Network Monitoring (RMON) MIB Hierarchy	1280
Figure 287: Example Uniform Resource Locator (URL).....	1290
Figure 288: File Transfer Protocol (FTP) Operational Model	1321
Figure 289: FTP Connection Establishment and User Authentication	1324
Figure 290: FTP Active Data Connection.....	1327
Figure 291: FTP Passive Data Connection	1328
Figure 292: FTP Reply Code Format.....	1341
Figure 293: TFTP Read Process	1358
Figure 294: TFTP Write Process.....	1360
Figure 295: TFTP Read Process With Option Negotiation.....	1362
Figure 296: TFTP <i>Read Request / Write Request</i> Message Format	1365
Figure 298: TFTP <i>Acknowledgment</i> Message Format.....	1366
Figure 297: TFTP <i>Data</i> Message Format.....	1366
Figure 299: TFTP <i>Error</i> Message Format.....	1367

Figure 300: TFTP <i>Option Acknowledgment</i> Message Format.....	1368
Figure 301: Electronic Mail (E-Mail) Communication Model.....	1377
Figure 302: MIME Multipart Message Structure.....	1414
Figure 303: MIME Base64 Encoding.....	1419
Figure 304: SMTP Transaction Session Establishment and Termination.....	1428
Figure 305: SMTP Mail Transaction Process.....	1432
Figure 306: Post Office Protocol (POP3) Finite State Machine.....	1454
Figure 307: Post Office Protocol (POP3) User Authentication Process.....	1455
Figure 308: Post Office Protocol (POP3) Mail Exchange Process.....	1459
Figure 309: Internet Message Access Protocol (IMAP) Finite State Machine.....	1467
Figure 310: Usenet (Network News) Communication Model.....	1489
Figure 311: Usenet Newsgroup Hierarchies.....	1493
Figure 312: NNTP Article Propagation Using The “Push” Model.....	1504
Figure 313: NNTP Full Newsgroup Retrieval Process.....	1507
Figure 314: Major Functional Components of the World Wide Web.....	1526
Figure 315: HTTP Client/Server Communication.....	1541
Figure 316: HTTP Request/Response Chain Using Intermediaries.....	1542
Figure 317: HTTP Request Message Format.....	1551
Figure 318: HTTP Response Message Format.....	1554
Figure 319: Impact of Caching on HTTP Request/Response Chain.....	1591
Figure 320: Telnet Communication and the Network Virtual Terminal (NVT).....	1615
Figure 321: Operation of the traceroute/tracert Utility.....	1645
Figure 322: Windows 95/98/ME <i>winipcfg</i> Utility.....	1669

List of Tables

Table 1: Version History.....	55
Table 2: Binary Information Group Representations and Terms	121
Table 3: Binary and Decimal Number Equivalents	124
Table 4: Binary, Octal and Hexadecimal Digit Conversion.....	127
Table 5: Hexadecimal to Decimal Number Conversion.....	128
Table 7: Decimal to Hexadecimal Number Conversion.....	130
Table 6: Decimal to Binary Number Conversion.....	130
Table 8: Binary Addition.....	131
Table 9: Hexadecimal Addition.....	132
Table 10: NOT Operator Truth Table.....	133
Table 11: NOT Operator Truth Table (Using Bit Values)	134
Table 12: AND Operator Truth Table.....	134
Table 13: OR Operator Truth Table	134
Table 14: Exclusive OR (XOR) Operator Truth Table	135
Table 15: Setting Bits Using an OR Bit Mask	137
Table 17: Inverting Bits Using an XOR Bit Mask.....	138
Table 16: Clearing Bits Using an AND Bit Mask	138
Table 18: OSI Reference Model Real-World Analogy	165
Table 19: OSI Reference Model Layer Summary	184
Table 20: TCP/IP Protocols: Network Interface Layer (OSI Layer 2)	199
Table 21: TCP/IP Protocols: Network Interface / Network Layer ("OSI Layer 2/3").....	199
Table 22: TCP/IP Protocols: Network Layer (OSI Layer 3).....	200
Table 23: TCP/IP Protocols: Host-to-Host Transport Layer (OSI Layer 4).....	201
Table 24: TCP/IP Protocols: Application Layer (OSI Layer 5/6/7).....	201
Table 25: PPP Phases.....	223
Table 26: PPP Base Standards	224
Table 27: PPP LCP Support Protocol Standards	225
Table 28: PPP Network Control Protocol Standards	225
Table 29: PPP Feature Protocol Standards	226
Table 30: PPP Application and Miscellaneous Standards	226
Table 31: PPP Compression Control Protocol (CCP) Compression Algorithms.....	244
Table 32: PPP Encryption Control Protocol (ECP) Encryption Algorithms	247
Table 33: PPP General Frame Format.....	255
Table 34: PPP <i>Protocol</i> Field Ranges	257
Table 35: Common Protocols Carried In PPP Frames and <i>Protocol</i> Field Values	258
Table 36: PPP Control Message Format.....	260
Table 37: PPP Control Messages, Code Values and PPP Protocol Usage.....	262
Table 38: PPP Control Message Option Format	263
Table 39: PPP Link Control Protocol (LCP) Frame Types and Fields.....	265
Table 40: PPP Password Authentication Protocol (PAP) Frame Formats.....	268
Table 41: PPP Challenge Handshake Authentication Protocol (CHAP)	

Formats	270
Table 42: PPP Multilink Protocol Fragment Frame Format.....	272
Table 43: Address Resolution Protocol (ARP) Message Format	294
Table 44: IP Address Classes and Class Characteristics and Uses	335
Table 45: IP Address Class Bit Patterns, First-Octet Ranges and Address Ranges	339
Table 46: IP Address Class Network and Host Capacities	342
Table 47: IP Address Patterns With Special Meanings	344
Table 48: Reserved, Loopback and Private IP Addresses	347
Table 49: IP Multicast Address Ranges and Uses	349
Table 50: Well-Known IP Multicast Addresses	350
Table 51: Determining the Subnet ID of an IP Address Through Subnet Masking	361
Table 52: Default Subnet Masks for Class A, Class B and Class C Networks	365
Table 53: Subnetting Summary Table For Class A Networks.....	374
Table 54: Subnetting Summary Table For Class B Networks.....	376
Table 55: Subnetting Summary Table For Class C Networks.....	377
Table 56: CIDR Address Blocks and “Classful” Address Equivalents	410
Table 57: Internet Protocol Version 4 (IPv4) Datagram Format.....	420
Table 58: Original Definition Of IPv4 <i>Type Of Service (TOS)</i> Field	424
Table 59: Internet Protocol Version 4 (IPv4) Option Format.....	426
Table 60: Internet Protocol Version 4 (IPv4) Options	427
Table 61: IPv6 Address Space Allocations.....	471
Table 62: Generic IPv6 Global Unicast Address Format.....	474
Table 63: IPv6 Global Unicast Address Format	474
Table 64: Historical IPv6 Unicast Routing Prefix Structure	476
Table 65: Example IPv6 Unicast Routing Prefix Structure.....	477
Table 66: IPv6 Multicast Address Format.....	487
Table 67: Important IPv6 “Well-Known” Multicast Addresses	489
Table 68: IPv6 General Datagram Structure	496
Table 69: IPv6 Main Header Format	497
Table 70: Common IPv6 <i>Next Header</i> Values	499
Table 71: IPv6 Extension Headers.....	503
Table 72: IPv6 <i>Routing</i> Extension Header Format.....	504
Table 73: IPv6 <i>Fragment</i> Extension Header Format.....	505
Table 74: IPv6 Option Format	508
Table 75: Operation Of Unidirectional (Traditional/Outbound) NAT	529
Table 76: Operation Of Bidirectional (Two-Way/Inbound) NAT	533
Table 77: Operation Of Port-Based (“Overloaded”) NAT	537
Table 78: Operation Of “Overlapping” NAT / “Twice NAT”	541
Table 79: Important IP Security (IPSec) Standards	547
Table 80: IPSec Authentication Header (AH) Format	563
Table 81: IPSec Encapsulating Security Payload (ESP) Format	568
Table 82: Mobile IP <i>Mobility Agent Advertisement Extension</i> Format	586
Table 83: Mobile IP <i>Prefix-Lengths Extension</i> Format.....	588
Table 84: Mobile IP <i>Registration Request</i> Message Format	592
Table 85: Mobile IP <i>Registration Reply</i> Message Format	593

Table 86: Non-ICMP Internet Standards That Define ICMP Messages.....	607
Table 87: ICMP Message Classes, Types and Codes.....	612
Table 88: ICMP Common Message Format	617
Table 89: ICMPv4 <i>Destination Unreachable</i> Message Format.....	621
Table 90: ICMPv4 <i>Destination Unreachable</i> Message Subtypes.....	622
Table 91: ICMPv4 <i>Source Quench</i> Message Format	625
Table 92: ICMPv4 <i>Time Exceeded</i> Message Format.....	628
Table 93: ICMPv4 <i>Redirect</i> Message Format.....	631
Table 94: ICMP <i>Redirect</i> Message Interpretation Codes.....	632
Table 95: ICMPv4 <i>Parameter Problem</i> Message Format.....	633
Table 96: ICMPv4 <i>Parameter Problem</i> Message Interpretation Codes	634
Table 97: ICMPv4 <i>Echo</i> and <i>Echo Reply</i> Message Format	637
Table 98: ICMPv4 <i>Timestamp</i> and <i>Timestamp Reply</i> Message Format.....	639
Table 99: ICMPv4 <i>Router Advertisement</i> Message Format	641
Table 100: ICMPv4 <i>Router Solicitation</i> Message Format	643
Table 101: ICMPv4 <i>Address Mask Request</i> and <i>Address Mask Reply</i> Message Format	645
Table 102: ICMPv4 <i>Traceroute</i> Message Format	647
Table 103: ICMPv6 <i>Destination Unreachable</i> Message Format.....	650
Table 104: ICMPv6 <i>Destination Unreachable</i> Message Subtypes.....	651
Table 105: ICMPv6 <i>Packet Too Big</i> Message Format.....	652
Table 106: ICMPv6 <i>Time Exceeded</i> Message Format.....	656
Table 107: ICMPv6 <i>Parameter Problem</i> Message Format.....	658
Table 108: ICMPv6 <i>Parameter Problem</i> Message Interpretation Codes	659
Table 109: ICMPv6 <i>Echo Request</i> and <i>Echo Reply</i> Message Format.....	661
Table 110: ICMPv6 <i>Router Advertisement</i> Message Format	663
Table 111: ICMPv6 <i>Router Solicitation</i> Message Format	665
Table 112: ICMPv6 <i>Neighbor Advertisement</i> Message Format	667
Table 113: ICMPv6 <i>Neighbor Solicitation</i> Message Format.....	669
Table 114: ICMPv6 <i>Redirect</i> Message Format.....	671
Table 115: ICMPv6 <i>Router Renumbering</i> Message Format	674
Table 116: ICMPv6 <i>Source Link-Layer Address</i> Option Format.....	677
Table 117: ICMPv6 <i>Target Link-Layer Address</i> Option Format.....	678
Table 118: ICMPv6 <i>Prefix Information</i> Option Format.....	679
Table 119: ICMPv6 <i>Redirected Header</i> Option Format.....	681
Table 120: ICMPv6 <i>MTU</i> Option Format.....	681
Table 121: RIP Version 1 (RIP-1) Message Format	724
Table 122: RIP Version 2 (RIP-2) Message Format	728
Table 123: RIPng Message Format.....	731
Table 124: Example OSPF Link State Database (LSDB)	737
Table 125: Example OSPF Link State Database (LSDB) With Costs.....	742
Table 126: Example Calculated OSPF Routes	745
Table 127: OSPF Common Header Format.....	748
Table 128: OSPF <i>Hello</i> Message Format	749
Table 129: OSPF <i>Database Description</i> Message Format	750
Table 130: OSPF <i>Link State Request</i> Message Format.....	752
Table 131: OSPF <i>Link State Update</i> Message Format.....	753

Table 132: OSPF <i>Link State Acknowledgment</i> Message Format	754
Table 133: OSPF <i>Link State Advertisement</i> Header Format	755
Table 134: Border Gateway Protocol (BGP) Versions and Defining Standards	768
Table 135: Additional Defining Standards For BGP-4	769
Table 136: Summary of BGP Path Attributes	779
Table 137: BGP General Message Format.....	786
Table 138: BGP <i>Open</i> Message Format	788
Table 139: BGP <i>Update</i> Message Format.....	791
Table 140: Details of BGP <i>Update</i> Message <i>Attribute Type</i> Subfield	794
Table 141: BGP <i>Keepalive</i> Message Format	797
Table 142: BGP <i>Notification</i> Message Format	798
Table 143: BGP <i>Notification</i> Message <i>Error Codes</i>	799
Table 144: BGP <i>Notification</i> Message <i>Error Subcodes</i>	800
Table 145: TCP and UDP Port Number Ranges	818
Table 146: Common TCP/IP Well-Known Port Numbers and Applications.....	824
Table 147: Common TCP/IP Registered Port Numbers and Applications.....	825
Table 148: UDP Message Format	830
Table 149: Common UDP Applications and Server Port Assignments	834
Table 150: Supplementary TCP Standards.....	839
Table 151: Common TCP Applications and Server Port Assignments.....	862
Table 152: TCP Finite State Machine (FSM) States, Events and Transitions	866
Table 153: TCP “Three-Way Handshake” Connection Establishment Procedure.....	873
Table 154: TCP Simultaneous Open Connection Establishment Procedure	875
Table 155: TCP Connection Termination Procedure	884
Table 156: TCP Simultaneous Connection Termination Procedure	887
Table 157: TCP Segment Format.....	890
Table 158: TCP Options.....	894
Table 159: TCP “Pseudo Header” For Checksum Calculation	896
Table 160: TCP Transaction Example With Send and Receive Pointers	907
Table 161: Summary Comparison of UDP and TCP	945
Table 162: Example TCP/IP Host Table.....	967
Table 163: Documents Discussing TCP/IP Domain Name System (DNS) Concepts	973
Table 164: Initial Standards Defining The TCP/IP Domain Name System (DNS).....	973
Table 165: Additional DNS Standards.....	974
Table 166: Internet DNS Organizational (Generic) Top-Level Domains.....	997
Table 167: Summary Of Common DNS Resource Records	1019
Table 168: Internet DNS Root Name Servers	1028
Table 169: DNS General Message Format.....	1058
Table 170: DNS Message <i>Header</i> Format	1061
Table 171: DNS Message <i>Question</i> Section Format.....	1065
Table 172: DNS Common Resource Record Format	1067
Table 173: DNS <i>Address</i> Resource Record Data Format.....	1068
Table 174: DNS <i>Name Server</i> Resource Record Data Format	1068

Table 175: DNS <i>Canonical Name</i> Resource Record Data Format.....	1068
Table 176: DNS <i>Start Of Authority</i> Resource Record Data Format.....	1069
Table 177: DNS <i>Pointer</i> Resource Record Data Format.....	1070
Table 178: DNS <i>Mail Exchange</i> Resource Record Data Format.....	1071
Table 179: DNS <i>Text</i> Resource Record Data Format.....	1071
Table 180: DNS Master File Format Syntax and Examples.....	1077
Table 181: Sample DNS Master File	1078
Table 182: NFS External Data Representation (XDR) Data Types.....	1090
Table 183: NFS Version 2 and Version 3 Server Procedures	1094
Table 184: NFS Version 4 Server Procedures	1096
Table 185: NFS Version 4 Server Operations.....	1097
Table 186: NFS Mount Protocol Server Procedures.....	1100
Table 187: BOOTP Message Format	1115
Table 188: BOOTP Vendor Information Field Format.....	1121
Table 189: DHCP Client Finite State Machine	1149
Table 190: DHCP Message Format.....	1173
Table 191: DHCP Option Format	1177
Table 192: DHCP Option Categories	1179
Table 193: DHCP/BOOTP Options: RFC 1497 Vendor Extensions.....	1181
Table 194: DHCP/BOOTP Options: IP Layer Parameters Per Host	1183
Table 195: DHCP/BOOTP Options: IP Layer Parameters Per Interface	1184
Table 196: DHCP/BOOTP Options: Link Layer Parameters Per Interface	1184
Table 197: DHCP/BOOTP Options: TCP Parameters.....	1185
Table 198: DHCP/BOOTP Options: Application and Service Parameters	1185
Table 199: DHCP Options: DHCP Extensions	1188
Table 200: SNMP Version 1 (SNMPv1) Standards	1218
Table 201: SNMP Security (SNMPsec) Standards	1218
Table 202: Party-Based SNMP Version 2 (SNMPv2p) Standards	1218
Table 203: Community-Based SNMP Version 2 (SNMPv2c) Standards.....	1219
Table 204: User-Based SNMP Version 2 (SNMPv2u) Standards	1220
Table 205: SNMP Version 3 (SNMPv3) Standards	1220
Table 206: SNMP SMI Version 2 <i>Max-Access</i> Values	1228
Table 207: SNMP SMI Regular Data Types	1229
Table 208: Example SNMP SMIv2 Object Definition.....	1230
Table 209: SNMP Generic MIB Object Groups	1235
Table 210: Some Common SNMP MIB Modules	1237
Table 211: SNMP PDU (Message) Classes	1244
Table 212: SNMP Variable Binding Format	1260
Table 213: SNMP Version 1 (SNMPv1) General Message Format.....	1261
Table 214: SNMP Version 1 (SNMPv1) Common PDU Format.....	1262
Table 215: SNMP Version 1 (SNMPv1) <i>Trap-PDU</i> Format	1264
Table 216: SNMP Version 2 (SNMPv2p) General Message Format.....	1266
Table 217: Community-Based SNMP Version 2 (SNMPv2c) General Message Format	1268
Table 218: User-Based SNMP Version 2 (SNMPv2u) General Message Format	1269
Table 219: SNMP Version 2 (SNMPv2) Common PDU Format.....	1271

Table 220: SNMP Version 2 (SNMPv2) PDU <i>Error Status</i> Field Values.....	1272
Table 221: SNMP Version 2 (SNMPv2) <i>GetBulkRequest-PDU</i> Format.....	1273
Table 222: SNMP Version 3 (SNMPv3) General Message Format.....	1277
Table 223: SNMP RMON MIB Object Groups.....	1281
Table 224: URL Special Character Encodings.....	1291
Table 225: Relative URL Specifications and Absolute Equivalents.....	1299
Table 226: FTP Access Control Commands.....	1336
Table 227: FTP Transfer Parameter Commands.....	1337
Table 228: FTP Service Commands.....	1337
Table 229: FTP Reply Code Format: First Digit Interpretation.....	1340
Table 230: FTP Reply Code Format: Second Digit Interpretation.....	1340
Table 231: FTP Reply Codes.....	1342
Table 232: FTP Multiple-Line Text Reply Example.....	1344
Table 233: FTP User Commands.....	1346
Table 234: Sample FTP Session.....	1348
Table 235: TFTP Options.....	1363
Table 236: TFTP <i>Read Request / Write Request</i> Message Format.....	1364
Table 237: TFTP <i>Data</i> Message Format.....	1365
Table 238: TFTP <i>Acknowledgment</i> Message Format.....	1366
Table 239: TFTP <i>Error</i> Message Format.....	1367
Table 240: TFTP <i>Option Acknowledgment</i> Message Format.....	1368
Table 241: RFC 822 Electronic Mail Header Field Groups and Fields.....	1393
Table 242: Multipurpose Internet Mail Extensions (MIME) Standards.....	1401
Table 243: MIME <i>text</i> Media Type Subtypes.....	1407
Table 244: MIME <i>image</i> Media Type Subtypes.....	1408
Table 245: MIME <i>audio</i> Media Type Subtypes.....	1408
Table 246: MIME <i>video</i> Media Type Subtypes.....	1408
Table 247: MIME <i>model</i> Media Type Subtypes.....	1409
Table 248: MIME <i>application</i> Media Type Subtypes.....	1410
Table 249: Example MIME Multipart Message.....	1415
Table 250: MIME Base64 Encoding Groups.....	1418
Table 251: Example SMTP Mail Transaction.....	1433
Table 252: SMTP Extensions.....	1435
Table 253: SMTP Commands.....	1439
Table 254: SMTP Reply Code Format: First Digit Interpretation.....	1442
Table 255: SMTP Reply Code Format: Second Digit Interpretation.....	1443
Table 256: SMTP Reply Codes.....	1443
Table 257: Example POP3 Authorization.....	1455
Table 258: POP3 Transaction Commands.....	1457
Table 259: Example POP3 Mail Exchange Process.....	1460
Table 260: IMAP “Any State” Commands.....	1470
Table 261: IMAP <i>Not Authenticated</i> State Commands.....	1473
Table 262: IMAP <i>Authenticated</i> State Commands.....	1474
Table 263: IMAP <i>Selected</i> State Commands.....	1477
Table 264: Usenet “Big Eight” Newsgroup Hierarchies.....	1491
Table 265: Usenet Header Categories and Headers.....	1496
Table 266: Common Additional Usenet Headers.....	1498

Table 267: NNTP Base Commands	1510
Table 268: NNTP Transport Extensions.....	1512
Table 269: NNTP <i>LIST</i> Command Extensions	1513
Table 270: NNTP Newsreader Extensions	1514
Table 271: NNTP Reply Code Format: First Digit Interpretation	1517
Table 272: NNTP Reply Code Format: Second Digit Interpretation	1518
Table 273: NNTP Reply Codes.....	1519
Table 274: Common Hypertext Markup Language (HTML) Elements	1530
Table 275: HTTP Status Code Format: First Digit Interpretation.....	1560
Table 276: HTTP Status Codes	1561
Table 277: HTTP <i>Cache-Control</i> Directives	1566
Table 278: HTTP <i>Warning</i> Header Codes	1569
Table 279: Example HTTP Response Using Content-Length Header	1586
Table 280: Example HTTP Response Using Chunked Transfer Encoding.....	1586
Table 281: Interpretation of Standard Telnet NVT ASCII Control Codes	1616
Table 282: Telnet Protocol Commands.....	1619
Table 283: Common Telnet Options.....	1623
Table 284: Using the <i>hostname</i> Utility To Check A Host Name	1637
Table 285: Verifying Communication Using the <i>ping</i> Utility.....	1640
Table 286: Common UNIX <i>ping</i> Utility Options and Parameters	1641
Table 287: Common Windows <i>ping</i> Utility Options and Parameters.....	1642
Table 288: Route Tracing Using the <i>tracert</i> Utility	1646
Table 289: Common UNIX <i>tracert</i> Utility Options and Parameters	1647
Table 290: Common Windows <i>tracert</i> Utility Options and Parameters	1647
Table 291: DNS Name Resolution Using the <i>nslookup</i> Utility	1650
Table 292: Typical <i>nslookup</i> Utility Commands	1651
Table 293: DNS Name Resolution Using the <i>host</i> Utility	1652
Table 294: Typical <i>host</i> Utility Options and Parameters.....	1653
Table 295: DNS Name Resolution Using the <i>dig</i> Utility.....	1654
Table 296: DNS Domain Registry Lookup Using the <i>whois</i> Program.....	1656
Table 297: Typical UNIX <i>netstat</i> Option Groups, Options and Parameters.....	1658
Table 298: Typical UNIX <i>netstat</i> Universal Options and Parameters.....	1659
Table 299: Sample Connections List From UNIX <i>netstat</i> Utility	1660
Table 300: Sample IP Statistics From UNIX <i>netstat</i> Utility.....	1661
Table 301: Typical Windows <i>netstat</i> Option Groups, Options and Parameters	1662
Table 302: Typical Windows <i>netstat</i> Universal Options and Parameters.....	1662
Table 303: Sample ICMP Statistics From Windows <i>netstat</i> Utility	1663
Table 304: Sample Routing Table Display From Windows <i>netstat</i> Utility	1663
Table 305: Typical UNIX <i>ifconfig</i> Syntaxes, Options and Parameters	1665
Table 306: Typical UNIX <i>ifconfig</i> Universal Options and Parameters.....	1665
Table 308: Sample Routing Table Display From Windows <i>netstat</i> Utility	1666
Table 307: Typical UNIX <i>ifconfig</i> Interface Configuration Parameters	1666
Table 309: Typical Windows <i>ipconfig</i> Options and Parameters.....	1667
Table 310: Simplified Configuration Information From Windows <i>ipconfig</i> Utility.....	1668
Table 311: Detailed Configuration Information From Windows <i>ipconfig</i>	

Utility.....	1668
Table 312: Miscellaneous TCP/IP Troubleshooting Protocols	1670

The TCP/IP Guide: Introduction and "Guide To The Guide"

Chances are pretty good that even before you started reading this Guide, you had heard of "TCP/IP"—even if you didn't know exactly what it was or even what all those letters stood for. The reason for this is simple: TCP/IP is **everywhere!** It is today by far the most commonly-used internetworking protocol suite. It has gained prominence in large part due to its role in operating the global Internet, which has in a few short years transformed our society in so many ways. Millions of people use TCP/IP and the Internet without really knowing how they work. For those in the technology field, however, understanding TCP/IP is becoming more important with each passing year.

As we journey together through this TCP/IP Guide, we will explore many hundreds of pages of material that will explain both the generalities and specifics of TCP/IP in a way that I hope you will find educational and interesting. Before diving into the actual technology, however, I felt that I should provide you with some introductory material to help frame the discussions that follow. Thus, I have included this section, to serve as an introduction to this Guide and to provide some information that will help you use it to its full potential.

I begin with some material that will be of interest to those who want to know the background of The TCP/IP Guide. I provide a general introduction to the Guide, describing its history, and how it came about. I then describe the goals of this Guide and what I was trying to accomplish in writing it. I also discuss the scope of the Guide, so you know what it covers and what it does not.

The rest of the section contains more practical information to help you best utilize this rather large document. I explain how the Guide is structured and organized, and discuss its special features. I then provide some specific tips to help you navigate the Guide using the Adobe Acrobat Reader software you are likely using at this moment. ☺ I also explain how you can provide feedback on the Guide and suggestions for improving it, and I conclude with a summary of the Guide's version history.



Note: There is no actual technical content in this section. If you are the type who buys something and starts using it right away without cracking open the manual, you may want to skip this section. If so, you should start by looking at the high-level discussion of the [TCP/IP protocol suite](#); alternately, you may wish to begin at the [Networking Fundamentals](#) section or with a look at the [OSI Reference Model](#). However, I do recommend at least skimming the topics in this section before you move on, especially the topics discussing the structure and organization of the Guide and its features. This will make the rest of the Guide easier to understand and probably save you time in the long run.

Introduction To The TCP/IP Guide

As I sit here writing this introductory material a few weeks before finishing off a multi-year project culminating in this TCP/IP Guide, I reflect on how funny life can be. Prior to a few years ago, I never really thought of myself as a writer. I have no training as an author, and my interests have always been in computers. I always assumed that I would end up in a technical job, such as computer programming or hardware design.

Perhaps ironically, then, it was my interest in personal computers that led to my writing The PC Guide in 1997. After I put the first version of that site online, I received many compliments on its usefulness. This didn't surprise me, since the material was of course designed to be useful. ☺ What shocked me were all the comments I received about how people appreciated my writing. They said they found my material easy to understand, and some said they had even read through textbooks but never understood the concepts they explained until they encountered my site. I discovered that I perhaps I had a talent I had never before considered; more, I realized that it felt good to dissect a difficult technical subject and help people understand it.

In early 2001 I decided that I wanted to embark on a new writing project to go along with the PC materials I had written in The PC Guide. I felt then, as I do now, that the future of information technology lies not so much in bigger and faster computers, but in better ways of exchanging information between them. I wanted to know more about networking and inter-networking. So, I decided to create a Networking Guide to complement my PC Guide. I thought that this would take about six months.

Remember what I said above about life being funny? ☺ Well, as soon as I embarked on my project to create a Networking Guide, I realized that I had opened a virtual Pandora's Box. I had never realized just how large a topic networking was; there were literally hundreds of different protocols, technologies, algorithms, concepts and devices to learn about. These were all interconnected in a myriad of ways, and it was hard to explain how one protocol or technology worked without first explaining another one. The amount of complexity was amazing.

To make matters worse, I found that it was very hard to find information about networks that really explained how everything worked. This seemed like an opportunity to me—I decided that since so many people felt I did a good job explaining PC technology, that I should take a crack at networking. Once I accepted that it would take more than six months, I figured I should plan on up to two years to get this writing project completed. Well... life is even funnier than I imagined. ☺ Fast forward from early 2001 to August 2003, and I find myself at my desk, looking over my writing project. I realize that I have been at this now for two-and-a-half years, yet due to my desire to cover as much as possible, I have at least a year's more work to go.

I began to feel burnt out from working on this new Networking Guide for such a long time, during which it has existed only in my mind and on my PC's hard disk drive. Even though part of me wanted to wait to finish the entire Networking Guide and publish it all at once, a larger part of me felt the need to publish at least some of what I had already written. I looked

over the material I had completed, and realized that most of the TCP/IP material was done. I felt TCP/IP was a topic that was particularly important in the Internet era, and one that I could cover as a standalone Guide. A few more months' work, and the TCP/IP Guide was born.

That's the story of the creation of an improbable TCP/IP Guide by an improbable author. ☺ You may look at the 1600-odd pages in this Guide and wonder at how this could be only a *part* of the document that I originally began. But that is in fact the case, and should give you an idea of just how large the complete project would have been had I waited to publish it in whole. Perfectionists should *never* start open-ended projects!

So, after nearly three years in all, the TCP/IP Guide is complete, and I am pretty pleased with how it came out. I feel that the breadth and depth of the coverage is unparalleled in any other single TCP/IP resource, and I have worked very hard to make my descriptions understandable and enjoyable to read. I spent many weeks designing the layout of the Guide, and many more creating and fine-tuning hundreds of examples and diagrams to help illustrate most of the technologies and concepts that underlie TCP/IP. Add to this the many benefits of electronic publication, such as a clickable table of contents, hyperlinks and a real-time search index, and I think this Guide will be of value to both beginners and advanced users alike. I hope you find it useful.

Goals of The TCP/IP Guide

Every author who sets out to write a book or other document has certain objectives that he or she hopes to accomplish when the work is completed. This is why you can go into a library or bookstore, pick up several books that cover the same subject, and discover that they are surprisingly different—not just in their content or scope, but in their entire approach to the material.

I too had a number of goals when I set out to write this Guide; you certainly don't need to know them in order to read and appreciate the material, but knowing what I had in mind while I was writing may help you while you are reading. And if you are reading this information prior to licensing The TCP/IP Guide, knowing what I strove for in writing the Guide may help you decide if this is the right resource for you.

My overall goal in writing this Guide was to create a resource that would allow anyone to obtain a deep understanding of how TCP/IP technologies really work. To accomplish this, I had a number of specific objectives that guided my writing efforts:

- ☉ **Comprehensiveness:** Like most authors writing a resource that covers a large subject, I wanted the TCP/IP Guide to be comprehensive. Of course no single document can cover everything, so I have had to limit [the scope of the material](#). However, I feel I cover more about TCP/IP as a whole than any other single book or other resource.

-
- ④ **Comprehensibility:** Creating a resource that is comprehensive is important, but I felt that it was even more important that the Guide be **comprehensible**. Over the past few years, I've had the opportunity to review many hundreds of books, guides, Web sites and papers related to networking. I have found that even though most of them are generally high in quality, too many use unexplained technical jargon or assume extensive prior knowledge of networking concepts and technologies on the part of the reader. I worked very hard to ensure that my descriptions, even of very complex concepts, can be understood by almost every student of networking.
 - ④ **Rationale:** It's certainly important to know how every TCP/IP protocol functions. However, to gain a true understanding of complex material, one also needs to understand the reasons behind why things are what they are. In writing this material I have always tried to explain not just the *what* but also the **why** of TCP/IP. I have anticipated and answered questions that I believed would commonly arise in the mind of someone learning about this technology.
 - ④ **Illustrations:** A picture is worth a thousand words, as they say. There are many concepts that no amount of verbiage will adequately explain, while a simple illustration will do the trick. For this reason, I spent many months creating over 300 full-color diagrams (some simple and some not so simple!) to complement the written material in The TCP/IP Guide.
 - ④ **User-Friendliness:** I have intentionally broken many of the rules of conventional book authorship, in creating a document that uses a conversational, first-person style, and no small amount of humor where appropriate. My intention was to make you feel at home while you read material that can be quite technically difficult. I want you to think of me like a friend sitting next to you at your computer explaining how TCP/IP works, rather than a professor preaching at you from a pulpit.
 - ④ **Organization:** Many networking books consist of dozens of subjects just listed one after the other, leaving the reader to wonder how everything fits together. When I first began this Guide, I spent weeks just organizing it, with the result being a [hierarchical structure](#) that indicates clearly how subjects are inter-related. I also carefully laid out each individual section to ensure that it covered its topic in a way that made sense.
 - ④ **Multiple Levels of Detail:** I realized that some people reading a TCP/IP Guide might only want a quick summary of the operation of its constituent protocols, while others want to learn all the nuances of how everything works. I have provided the full details that most readers will want, while also providing overview topics in each section that summarize each technology for quick perusal. This gives you the option of either skimming the surface or "diving deep", as you choose.
 - ④ **Platform Independence:** I have endeavored whenever possible to avoid describing TCP/IP in terms specific to any hardware or software platform. Even though I use a PC for most of my computing and UNIX for other aspects, most of the material is not particular to any type of device or operating system (though I do focus more on networks of smaller computers than larger ones).

How successful was I in achieving these goals? I'd like to think I did a pretty good job, but ultimately, you will be the judge!

Scope of The TCP/IP Guide

The first step to dealing with a problem is recognizing that you have one. So, I have to come clean with you, my reader. I have a problem: an addiction to... detail. ☺ Every time I set out to write about a particular protocol, technology or concept, I start with a modest goal regarding how much I want to write. I always begin knowing that I really need to control myself, to prevent my project from going on forever. But as I explore each subject, I learn more and more, and I start to say to myself things like... “this is important, I simply **must** include coverage for it” and... “if I am going to cover subject #1, I also should cover subject #2, because they are related”. This is [how I turned a six-month project into a multi-year ordeal](#). ☺

However, even though self-control in this area is a weakness for me, even *I* realized I could not possibly cover **everything** related to TCP/IP in this Guide. Consider that the TCP/IP suite contains dozens of protocols and technologies that have each had thick books written about them. I was willing to spend years on this project but not decades. ☺ Thus, I had to limit the scope of this Guide somewhat, both to preserve what remains of my sanity and to spare you from having to wade through a ridiculously large document.

Here are a few different points that will help explain decisions that I made to limit the scope of The TCP/IP Guide:

- ☺ **Theory versus Practice:** This is primarily a *reference resource* on the TCP/IP protocol suite. The material here is designed to allow a student to learn the nuts and bolts of how TCP/IP works. I do discuss quite a number of “real-world” practical issues related to how TCP/IP internetworks operate, but this is not my primary focus here. If you want to really understand what TCP/IP is and what makes it work, you’ve come to the right place. If all you want is simple instructions on how to connect a few PCs together in your home using TCP/IP, this probably isn’t the Guide for you. ☺
- ☺ **Current versus Future Protocols:** Most of the emphasis in this Guide is on the present state of the art in TCP/IP. The suite is always changing, and there are constantly new protocols being written and revisions to existing protocols being published. I have not provided extensive coverage of technologies still in development, to try to keep the size of the Guide manageable, and to reduce the number of changes I will have to make to keep the material up-to-date.

The one exception to this general rule of thumb is version 6 of the Internet Protocol. IPv6 represents a significant change to the core of how most of TCP/IP operates. While not universally deployed yet, IPv6 is sufficiently far along in its development that I feel any student of TCP/IP needs to know what it is and how it works, and understand its significance. Thus, I have included a [detailed section describing it](#), and also mentioned how it impacts the operation of several other key protocols such as [ICMP](#), [DNS](#) and [DHCP](#).

- ☺ **Application Coverage:** There are many thousands of different applications that run on TCP/IP internetworks, and I could not possibly hope to describe all of them. The scope of this Guide is limited to the most important, [“classical” TCP/IP applications and application protocols](#), such as electronic mail, general file transfer and the World Wide Web.

-
- ☉ **TCP/IP versus The Internet:** The TCP/IP protocol suite and the Internet are very closely related in many ways, as you will discover as you read this Guide. In fact, they are often tied together so much that it is hard to discuss one without the other. However, the Internet as a whole is an enormous subject, and trying to describe it in general terms would have substantially increased the size of this Guide. Thus, I describe Internet issues only within the context of explanations of TCP/IP technologies.

For example, while I cover the [World Wide Web](#) in this Guide, I discuss its generalities only briefly. I focus my technical discussions on how the [Hypertext Transfer Protocol \(HTTP\)](#) that implements it works. I don't talk all about how to set up a Web site, or how to choose a Web browser, or any of those sorts of details. These are covered in a dazzling array of different books, papers and of course, Web sites. ☺

- ☉ **Limited TCP/IP Security Coverage:** Security is a very important and very large topic, especially in modern networking. This Guide does include a fairly detailed section on the operation of the [IP Security protocols \(IPSec\)](#), and also touches upon security issues in describing several other protocols and technologies. However, it is not specifically geared towards detailed discussions of security considerations. It is possible that in the future I will add more security-related information, but for now, if your primary interest is TCP/IP security matters, you will want to supplement this Guide with other materials.
- ☉ **Small Computer Orientation:** In general terms, TCP/IP technologies can be used to connect together any types of devices that have the appropriate hardware and software. There are some issues, however, where explanations require me to focus on how specific types of underlying networks and devices work; this is especially true of some of my diagrams. In these cases, my preference has generally been to show how TCP/IP is used to connect together typical small computers such as PCs, Macintoshes and UNIX workstations, which are what most people use.

Structure and Organization of The TCP/IP Guide

You may have already noticed that the TCP/IP Guide is organized in a way that is very different from most books. I believe this structure will help you not only find the information you need easily, it will even assist you in understanding the content. However, because it is unorthodox, I want to take a few moments to explain what I have done and why.

In reviewing other networking books and materials before I wrote this Guide, I was consistently disappointed--not in the descriptions of the various subjects, but in the way they were organized. Invariably, these resources would cover a lot of material, but it would be presented as a poorly-structured set of seemingly unrelated chapters—"subject salad" as I sometimes call it. A typical networking book would have dozens of little chapters cobbled together and presented almost as if they were independent of each other. The reader had to figure out how they all connected, and also had to wade through several repeated descriptions of similar concepts, due to aspects that were common between certain technologies. This was all exacerbated by the inability to hyperlink between related topics in a print book.

TCP/IP is a complex topic largely because so many of the concepts and technologies are closely related. TCP/IP as a whole consists of a number of defining concepts and a large number of individual protocols, many of which interact in a specific way. Many of those protocols in turn consist of either subprotocols or descriptive elements that are related to each other in a particular fashion. For example, you can't easily describe IP datagram formatting without making reference to IP addressing, which in turn is related to IP routing, which is of course related to IP routing protocols, and so forth.

For this reason, I didn't want to just make this book consist of several dozen chapters slapped together as peers and leave you to figure out how they fit together. So, I spent several weeks just trying to come up with a way to describe TCP/IP technologies in a coherent, organized way that made sense. My primary goal was to come up with a structure that would clearly show how all the various protocols, concepts and technologies were interrelated, to help you understand the subject as a whole, and not just as a collection of parts.

The result of this effort is that rather than using a set of dozens of chapters all at the same level, this Guide uses a *hierarchical* structure with many levels. The Guide contains several sections on various high-level subjects, which we will explore in a moment. Most of these contain subsections that describe components or more detailed elements within the higher-level subject. These in turn can contain their own subsections and so on, possibly going down several layers in detail.

The Guide is formatted so that each section header and section starts at the top of a page. This facilitates printing small sections of information (for use as handouts in a classroom setting, for example) and also helps make navigating using hyperlinks easier. A special horizontal divider graphic is used to clearly mark the end of each section.

Another organizational feature of this Guide is that I have made extensive use of *overview* topics. Most sections that include multiple individual topics begin with an overview topic that provides a high-level look at the contents of that section. These serve two purposes. First, they introduce the subject and provide a context for understanding the detailed discussions that follow it, for those who want to read about the protocol or technology in detail. Second, they serve as a "short cut" for those who do not wish to read an entire section. Some large sections containing subsections will have an overview for the section as a whole, and an overview for some of the subsections as well. This is by design, to provide you with flexibility in choosing what you want to read.

Some of you might find that this all of this takes a bit of getting used to, but it has advantages compared to a "flat" set of chapters. The hierarchical structure itself helps you understand how the many protocols, concepts and other bits and pieces of TCP/IP fit together. It shows you what aspects of TCP/IP are closely and more distantly related. The hierarchy and the use of overview topics allows you to explore a particular subject of interest in the manner you choose, by enabling you to easily choose some subsections to delve into while skipping others that you may already understand or simply not wish to know.

So, where to begin in exploring this large Guide? Well, you can just read the entire thing from cover to cover, but most people lack the time and patience to do that! The key to taking advantage of this Guide's hierarchical structure is to make use of the nested bookmarks that should appear on the left side of your Adobe PDF reader. These let you clearly see the structure of each part of the Guide and let you instantly jump to any topic of interest. The next two topics describe in more detail [features of the Guide](#) and how to [optimize your use of Adobe Acrobat Reader](#).

Chapters of The TCP/IP Guide

Due to the hierarchical structure just described, there are only six “top-level” sections in this Guide, which I sometimes called *chapters*. You will probably find that it usually makes the most sense to begin with these higher-level sections and work your way down to the more detailed topics they contain. Here is a brief description of each, to get you started:

- ☉ [Introduction and “Guide To The Guide”](#): You're reading it! ☺
- ☉ [Networking Fundamentals](#): This is a background chapter that provides lots of useful general information on networks for those who may be very new to the entire subject. It has subsections that explain what networking is, discuss key networking characteristics, describe networking standards, provide information on binary mathematics and much more. If you are experienced with networks and computers in general you may wish to skip this (or at least, skim it and only read the topics that interest you).
- ☉ [The Open System Interconnection \(OSI\) Reference Model](#): A description of the important OSI Reference Model, which is used extensively to explain networking architectures and protocol layering concepts. Unless you already know and understand the OSI model, this section is worth reading before getting into the “meat” of the Guide.
- ☉ [TCP/IP Protocol Suite and Architecture](#): This is the first section that is specifically about TCP/IP; it introduces the protocol suite and discusses it in general terms. This includes a look at its history, a description of the TCP/IP architectural model and an overview of key protocols. It should be the place to start reading about TCP/IP for virtually everyone using this Guide, as it provides necessary background information and a context for understanding the more detailed chapters below.
- ☉ [TCP/IP Lower-Layer \(Interface, Internet and Transport\) Protocols \(OSI Layers 2, 3 and 4\)](#): This large chapter describes all of the TCP/IP protocols that operate at layers 2 through 4 of the OSI model, and is organized by layer for easier reference by function. This chapter encompasses about half the entire Guide; it includes all of the most important “core” TCP/IP protocols, including IP, IPv6, ICMP, UDP, TCP and much more.
- ☉ [TCP/IP Application Layer Protocols, Services and Applications \(OSI Layers 5, 6 and 7\)](#): This chapter is also very large, as it covers all the TCP/IP application protocols and services that correspond to the upper three layers of the OSI Reference Model. This includes protocols such as DNS, DHCP, SNMP, FTP and HTTP, as well as applications such as electronic mail, the World Wide Web and diagnostic utilities.

As you can see, most of this Guide is actually contained in the last two chapters, since TCP/IP is primarily defined by the functions of its various protocols.

TCP/IP Guide Features, Inserts and Icons

I created The TCP/IP Guide to provide you with an unparalleled breadth and depth of information on TCP/IP. This meant including a lot of content in this Guide—it has over 600 sections, subsections and individual topics, and is over 1,600 pages long. However, I recognized as I was writing this tome that the real goal is not just to provide a lot of detailed information, but also to present it in such a way that it can be easily understood by you, the reader. This requires more than just writing large amounts of text and putting it all into a large file.

For this reason, I have incorporated a number of special features into this Guide to help make it easier for you to “digest”. ☺ These include tools that will help you navigate through the information, others that let you quickly jump to related topics, and graphical elements that explain difficult topics or simply highlight important text elements. Most of these features are also designed to exploit the many advantages of electronic documents, such as hyperlinking and the ability to embed full-color graphics.

Special Features

Here is a description of some of these special features, in no particular order:

- ☺ **Hierarchical Table of Contents:** The TCP/IP Guide uses a hierarchical structure, which I described in detail in [the previous topic discussing the Guide’s organization](#). A complete [Table of Contents](#) has of course been included, which reflects this hierarchical structure. It is fully hyperlinked, so you can quickly jump to any topic of interest just by clicking your mouse on the topic’s title.

For your convenience, there is also a link to the Table of Contents in the footer of each page. Just click on the word “[Contents](#)” that appears after the name and version number of the Guide.

- ☺ **Hierarchical Bookmark List:** The Table of Contents mentioned just above is also implemented as a set of hierarchical bookmarks, which should automatically appear in a window pane on the left side of your screen when you open the Guide in Adobe Acrobat. These bookmarks are convenient, since they remain open while you read the Guide. You can use them to check your current location in the document, and to jump to any section or topic. [See the next topic for details on how to find these bookmarks](#) if they do not appear automatically when you open the Guide.
- ☺ **Figures:** The TCP/IP Guide contains over 300 full-color illustrations, which support the text descriptions of TCP/IP technologies and protocols, and help make sense of difficult concepts. Each figure is cross-referenced with a hyperlink from an appropriate place in the text. Most include brief descriptions that allow you to understand what the figure means without even having to read the full text of the topic where the figure is located.
- ☺ **Tables:** The Guide has over 300 tables, which present large amounts of information in an organized and readable manner, or highlight examples for your convenience. These tables use alternating white and colored rows for enhanced readability. Like the figures, these tables are cross-referenced from the text using hyperlinks.

-
- ☉ **Lists of Figures and Tables:** I have provided a [List of Figures](#) and a [List of Tables](#) to allow you to easily find any figure or table using either its number or title. Like the Table of Contents, all entries on these lists are hyperlinked for your convenience.
 - ☉ **Hyperlinks:** In addition to the hyperlinks in the Table of Contents and lists mentioned above and the cross-references to figures and tables, there are over 3,000 additional hyperlinks within the actual text of the Guide. These links are shown in blue text; when you see one, clicking it will take you to the topic discussing whatever subject matter was highlighted by the link. This lets you quickly find information relevant to understanding the topic you are currently exploring.

Note that all hyperlinks that appear in the main part of this Guide are internal links that go to other places within the Guide; external links are shown separately (see below).

- ☉ **Highlighting:** I use a consistent highlighting mechanism to make the text easier to read. When new terms are introduced they are shown in *italics*; I also italicize the names of fields, messages, options and other protocol constructs to set them apart from regular text. Emphasized words are shown in ***bold italics***. Document titles are *italicized and underlined*. There are also a few places where colored text is used for emphasis.
- ☉ **Full Text Search:** The TCP/IP Guide does not have a conventional index of topics like most books because it has something better—the ability to search for any string and have the PDF file viewer software automatically take you to each place where it occurs in the document. This is described in detail in [the next topic](#).

Inserts and Icons

Most of the text discussions in The TCP/IP Guide are shown as free-form text as you would expect in any document. However, there are certain situations in which I want to provide you with a piece of information that is either not directly related to the subject of the main text, or is deserving of your special attention. For these purposes, the Guide uses a set of special *inserts*, each of which is clearly marked by a particular icon, and called out from the text using a pair of horizontal bars. There are five different inserts used in the Guide, which I have shown and described below.



Note: This insert used when I need to clarify or explain something that I feel you need to know, but which is either not directly related to the topic under discussion, or is sufficiently “tangential” that it needs to be separated from the main text to avoid disrupting its flow. Examples include terminology explanations, “sidebar” historical discussions, anecdotes, and clarifications relating to how I am describing particular concepts.



Key Concept: I tried very hard in crafting this Guide to provide a variety of ways to present information, to better suit the learning styles of different readers. To that end, I have created hundreds of these inserts, which summarize and highlight the most important concepts and essential pieces of knowledge in The TCP/IP Guide. They can be very useful for quickly distilling the essence of a topic without reading an entire explanation, or for refreshing your memory of a topic you have already read. Obviously, however, they contain few details, so you should not assume that you fully understand a topic or concept just by reading this sort of summary.



Background Information: When you see this insert near the front of a section or a particular description, it indicates that I am recommending that you read another part of the Guide before proceeding with that section. While I have attempted to make each section able to stand alone to a certain degree, some just make more sense if read in a particular order (usually the order in which the sections are listed within their parent section).



Related Information: This insert mentions another section or topic within The TCP/IP Guide that contains information related to the section where the insert is located, but which is not background material. It may help you understand the content you are reading, or put it into better context.



On The Web: This insert is used when I need to link to a relevant document or resource on the World Wide Web. The insert contains a brief description of the linked item and its URL, highlighted in blue italics.

Be sure to also read the next topic, which provides some very useful advice on how best to use the Adobe Acrobat (PDF) Reader software. This will help you get the most of the features I have just described.

Tips For Using Adobe Acrobat Reader To View The TCP/IP Guide

The TCP/IP Guide is packaged as an Adobe Acrobat *portable document format (PDF)* file. PDF files are normally viewed using a software program called the *Adobe Acrobat Reader* (or just *Adobe Reader*). Since Acrobat has become the industry standard for distributing electronic documents, you have probably used it to view PDF files many times in the past.

Some of you, however, may be new to PDF files, and most others have probably never used it to view a document of this size. I felt it would be helpful to provide you with a few suggestions for how best to use the software to view this Guide.

Obviously, I cannot begin to explain all the features and options in the Adobe Acrobat software, nor would I wish to try. You should consult the built-in help features of the program for general assistance on how to use it. My interest here is only in highlighting some specific Acrobat tools that I think will help you in best navigating the Guide and benefitting from its features.

So, here are some specific tips to getting the most of The TCP/IP Guide using the Adobe Acrobat Reader. These are based on version 6 of the software, running on a Windows PC platform. Note that earlier versions of the software may not have all of the features I discuss below. Versions running on other operating systems likely have the same features, but may be accessed using different menu options or key sequences.

Basic Navigation

To move through the document:

- ☉ Use the “Up Arrow” and “Down Arrow” keys to go up or down one line.
- ☉ Use the “Page Up” and “Page Down” keys to go up or down one screenful of information.
- ☉ Use the “Left Arrow” and “Right Arrow” keys to go up or down one full page. (This may be the same as a full screen if you have the viewing mode set to display exactly one full page at a time on the screen.)
- ☉ Use the “Home” key to go to the first page, or “End” to go to the end of the Guide.

You can also use the scroll-wheel on most mice to navigate through the document, or the scroll bar on the right side of the document. There are also arrow buttons for navigation, at the bottom of the page on either side of the page number display, and the “View Menu” has a “Go To” submenu with navigation options as well.

Hyperlinks

Hyperlinks are shown in blue text; when you move the pointer over one, it will change from a hand to a pointing finger. Just click the link to go to its target.

To return to the place where the link was located, select the “View” menu, then “Go To” and “Previous View”, or more easily, press “Alt+Left Arrow”. The small green button pointing to the left at the bottom of the screen does the same thing. This is **very** useful when you want to follow a hyperlink quickly to check a related piece of information and then return back to the place where you were reading. You can do this multiple times as well—if you click three hyperlinks in sequence, you can go back three times to each hyperlink in sequence.

Enabling Bookmarks

When you open The TCP/IP Guide, a pane should automatically appear on the left side that shows the contents of the document in a hierarchical structure identical to [the structure of the Guide itself](#). Use these bookmarks to navigate the Guide and jump to topics of interest.

If for whatever reason the bookmarks are not displayed, click the vertical “Bookmarks” tab on the upper left of the document area to show them, or select the “View” menu, then “Navigation Tabs”, then “Bookmarks”.

Wrapping Long Bookmarks

Some of the section and topic titles in The TCP/IP Guide are quite long, and by default, you may only be able to see the first few words of each in the bookmarks area. To see the full title, click on the “Options” drop-down box in the bookmarks window, then select “Wrap Long Bookmarks”.

Jumping To A Particular Page

Most often, you will find that it is easiest to jump to a particular section or topic using the bookmarks, the [Table of Contents](#) or text hyperlinks. However, you can also go to a specific page number manually. Either click on the current page number near the bottom of the page and enter the number of the page you want, or press “Shift+Control+N” to bring up the “Go To Page” dialog box.



Note: I have intentionally numbered the entire Guide starting with page number 1—as opposed to restarting the page numbers after the Table of Contents and so forth—so that the Adobe Acrobat page numbers and document page numbers are identical.

Zooming

By default, The TCP/IP Guide opens up at 100% (actual size) magnification. This provides the best quality of text and graphics on most monitors, but may not be suitable for some displays, especially very small or large ones. You can change the displayed size in a variety of ways. Select a different magnification using the zoom factor drop-down box at the top of the program, or click one of the pictures of a piece of paper there. To bring up a dialog box with zoom options, select the “View” menu and then “Zoom To...”, or press “Ctrl+M”. If you are not sure what magnification to use, try making the Acrobat window full-screen and then selecting “Fit Width”.

Page Layout

By default, the Guide displays as a continuous scroll of pages, as I find this usually makes reading a long document easier. It also enables hyperlinks to properly position the document to the exact location of the target of the link. If you prefer, you can change to

single page layout by selecting the “View” menu, then “Page Layout”, then “Single Page”. If you do this, however, when you click a hyperlink, it will load the target page number without scrolling to the title of the hyperlink’s target.

Text Search

To search for a term or phrase, select the “Edit” menu, then “Search”, or press “Ctrl+F”. This should cause a *pane* to appear on the right side that presents a few options for you to search the Guide. A few specific pointers here:

- ☉ To search for a word or phrase, simply enter it into the box at the top of the search pane. A results box will come up containing just the single TCP/IP Guide document; click the “+” next to it for a list of each location in the document where the word or phrase occurs. Select one and you will be taken directly to it.
- ☉ To instantly go to the next search result, press “Ctrl+G”; to go to the previous one, press “Shift+Ctrl+G”. Of course, you can also just select a different result from the box, rather than moving through each one in sequence.
- ☉ For more advanced searches, click “Use Advanced Search Options” near the bottom of the search window.
- ☉ Click “New Search” to look for a different word or phrase, or use the “Hide” button at the top right to close the search pane.
- ☉ The Guide comes with a precompiled index that makes searching through it very fast despite its size. This index should be automatically loaded when you open the Guide. Make sure it is selected by checking that under “Where would you like to search?” the button is next to “In the index named The TCP-IP Guide.pdx”. If you select instead “In the current PDF document”, the software will search through every page one by one which will take a long time.

If the index is not present as an option in the search box, try adding it manually. Click “Use Advanced Search Options” near the bottom of the search pane. Then click the “Look In:” drop-down box to see if the index is listed. If it is, select it, otherwise, click “Select Index...”. Then click “Add” and navigate to the location on your computer’s hard disk or CD-ROM drive where The TCP/IP Guide is located. Select “The TCP-IP Guide.pdx” and it should attach the index to the document. Then click “Use Basic Search Options” near the bottom of the window to return to the simpler search box.



Note: If you experience errors when attempting to use the index, this may be due to an issue with older versions of Adobe Acrobat Reader (even though the PDF was created to allow compatibility with older software!) Try upgrading to the latest version of the software; [you can download it free from Adobe’s Web site](#). Sorry for the inconvenience.

Feedback and Suggestions

One of the ways that this Guide differs from the typical technical reference book is that it is a very *personal* work. When you read the material here, I want you to feel like I am explaining the many technologies and concepts to you personally, because that's how I feel when I am writing. A published Guide of this sort is by its nature a type of "one-way" communication, from me to you; however, I am also interested in what you have to say to me. For this reason I strongly encourage you to provide me with feedback on this Guide and suggestions that you may have for it.



On The Web: All technical documents have mistakes in them; this one is no exception, which is why the Guide is revised regularly. Before contacting me regarding an error or problem with this Guide, please check to see if you have the latest version, which may have addressed your concern; the list of versions and the major changes they contain is at <http://www.tcpipguide.com/versions.htm>. If you are reading the current version, please check the errata page, to see if what you found has already been reported. That page can be found here: <http://www.tcpipguide.com/errata.htm>

Please Write Me About...

Here, specifically are some of the areas where I would very much like your feedback:

- ☉ **Error Reports:** Please don't be shy about reporting any errors you may find with this Guide, be they typos, mistakes in my reasoning, glitches in diagrams or anything else. Simply put, I'm not perfect, and I can't fix problems that I don't know exist.

If you do decide to report an error, please check the errata page mentioned above before contacting me. If your problem is not mentioned there, please e-mail me (see below) and indicate clearly what version of the Guide you are using, and the topic name or page number where you found the problem.

- ☉ **Constructive Criticisms and Suggestions for Improvement:** If there is something you don't like about the material, please tell me. Even better, make a suggestion for how to improve it.
- ☉ **Requests For Additional Content:** Is there an area of the Guide where you wish I had gone into more detail, or a protocol you feel I should have covered but did not? Please feel free to let me know.
- ☉ **Compliments:** If you like The TCP/IP Guide, then by all means please tell me, I won't mind at all! 😊
- ☉ **Questions About The Guide:** Questions that pertain directly to the use of the Guide, its construction, or related matters are fine.

Obviously I cannot guarantee that I will implement every idea or suggestion, but I will certainly consider each one. I also try to always respond to my e-mail personally, since I think it is rude for me not to reply when someone takes the time to provide me with feedback. (I do not, however, usually bother to reply to "flaming" or rude e-mails.)

Please Do Not Write Me About...

The only request I would make is this: ***please do not contact me with technical questions or requests for assistance***. I'm a pretty busy guy and I get a lot of e-mail. I simply do not have the time to help people with specific problems. Since I initially wrote my first project (The PC Guide) in 1997, I have repeatedly asked people not to send me technical questions, but they keep doing it. I have now had to take the position of simply ignoring such messages. Specifically, I ***will not respond*** to the following:

- ☹ Requests for network or PC design, setup, configuration or troubleshooting assistance. There are a number of excellent resources for assistance with these types of issues on the Web, such as The PC Guide Discussion Forums (see below).
- ☹ Questions from exams, certification practice tests, and so forth. Please do your own homework, if you want to learn anything at all.
- ☹ Requests for me to write long treatises about TCP/IP protocols or technologies that go beyond what this Guide already contains. There's a lot of detail here, but I obviously couldn't include everything that everyone might have wanted to know about. If you don't find what you need here, try using another TCP/IP book, or searching the Internet for the information you need. I am happy to consider requests for enhancements to future versions of the Guide, but I do not have the time for personal instruction.



On The Web: If you do need help or advice with networking problems or issues, try The PC Guide Discussion Forums. While many of the discussions there are oriented specifically around PC hardware and operating system issues, there are also forums dedicated to networking concerns. You can find them here: <http://www.pcguides.com/forums>

My Contact Address

Now that you have read all that—you did read it, didn't you? ☺—you can reach me through e-mail at this address: tcpipfb@tcpipguide.com

Version History

Like all technical documents, The TCP/IP Guide must be revised on a regular basis, to correct problems and make updates to reflect changing technology. The fact that the Guide is self-published in electronic form allows me to update it much more often than is possible with a printed book. To differentiate between successive revisions of the Guide, I use a version number system; you can find the version number of the document you are reading right now in the footer of each page. I also provide a history of the Guide's past versions in this topic, for your reference.

The version number takes the form “N.N”, where each “N” is an integer. The right-most digit is the minor version number; it is incremented whenever a new version of the Guide is published that contains only relatively minor fixes and improvements. The left-most digit is the major version number, and is changed only when significant changes are made to the Guide, such as a large number of fixes and enhancements, or the addition of substantial new content.



On The Web: The version history in this topic is obviously only current as of the date that this particular version of the Guide was published. The most recent list of versions can be found at <http://www.tcpipguide.com/versions.htm>. Also, even though this is an electronic document, a fair bit of work is still required to publish each new version. Therefore, I do not put out a new version each time a problem is reported to me or I make a minor enhancement. To see a list of problems or issues that are due to be corrected in the next version, please check The TCP/IP Guide errata page: <http://www.tcpipguide.com/errata.htm>

The version history of The TCP/IP Guide can be found in [Table 1](#).

Table 1: Version History

Version Number	Version Date	Description
1.0	January 1, 2004	Initial release of The TCP/IP Guide.
2.0	June 7, 2004	Extensive rewrite of version 1.0 of The TCP/IP Guide. The Guide was thoroughly reviewed by two TCP/IP experts and numerous technical errors and clarity problems were addressed. Most of the larger topics have had subheaders added to make them more readable. Hundreds of other minor glitches, typos and problems have also been corrected.
3.0	Sept. 20, 2005	This release contains dozens of technical corrections, grammatical fixes and other minor improvements. Technically, this might only have been worthy of a minor upgrade (to version 2.1) but since this version coincides with the publication of The TCP/IP Guide print book, I decided to go straight to version 3.0.



Networking Fundamentals

In order to get the most of The TCP/IP Guide, a certain level of knowledge regarding the basics of networking is very helpful. Unlike many other resources, however, I did not want to start with the assumption that my reader knew what networking was all about. After all, that's why you are reading this Guide!

So, I decided to include this section, which provides an overview of some of the basic issues related to networking. This area is where I place discussions of some of the most fundamental networking concepts and ideas. It serves not only to provide you, the reader, with useful background material, but also as a repository for “general” information so that I don't need to repeat it in many different places elsewhere in the Guide. This in turn allows those who already know about these basics to avoid having to skip over them in many other locations.

In this section I have provided several subsections that introduce networking and talk about some of its most important fundamental concepts. First, I introduce networking in very broad terms, discussing what it is and why it is important. Then, I describe several fundamental characteristics of networks that you will need to understand the various networking technologies. I discuss the different general types and sizes of networks and how they are differentiated. I then talk about many different matters related to network performance. I explain the importance of networking standards and standards organizations. Finally, I provide a background section that describes the fundamentals of how data is stored and manipulated in computers; if you are new to computing you may find that information useful when reading some parts of this Guide.



Note: If you are experienced in networking and related technologies, you may wish to skip this chapter. Hyperlinks in other areas of the Guide refer back here as appropriate, so if you need to “fill in” your knowledge of a particular fundamental “on the fly” you can do so rather easily.



Note: This section discusses fundamental networking issues that may be of use in understanding certain TCP/IP concepts. However, some of the material is very broadly oriented towards discussions of networking as a whole and is not specific to TCP/IP internetworking.

Introduction to Networking

In this day and age, networks are everywhere. The Internet has also revolutionized not only the computer world, but the lives of millions in a variety of ways even in the “real world”. We tend to take for granted that computers should be connected together. In fact, these days, whenever I have two computers in the same room, I have a difficult time **not** connecting them together!

Given the ubiquitousness of networking, it's hard to believe that the field is still a relatively young one, especially when it comes to hooking up small computers like PCs. In approaching any discussion of networking, it is very useful to take a step back and look at networking from a high level. What is it, exactly, and why is it now considered so important that it is assumed that most PCs and other devices should be networked?

In this section, I provide a quick introduction to networking, discussing what it is all about in general terms. I begin by defining networking in the most general terms. I then place networking in an overall context by describing some of its advantages and benefits, as well as some of its disadvantages and costs.

What Is Networking?

For such an extensive and involved subject, which includes so many different technologies, hardware devices and protocols, the definition of networking is actually quite simple. A network is simply a collection of computers or other hardware devices that are connected together, either physically or logically, using special hardware and software, to allow them to exchange information and cooperate. Networking is the term that describes the processes involved in designing, implementing, upgrading, managing and otherwise working with networks and network technologies.



Key Concept: A network is a set of hardware devices connected together, either physically or logically to allow them to exchange information.

Networks are used for an incredible array of different purposes. In fact, the definitions above are so simple for the specific reason that networks can be used so broadly, and can allow such a wide variety of tasks to be accomplished. While most people learning about networking focus on the interconnection of PCs and other “true” computers, you use various types of networks every day. Each time you pick up a phone, use a credit card at a store, get cash from an ATM machine, or even plug in an electrical appliance, you are using some type of network.

In fact, the definition can even be expanded beyond the world of technology altogether: I'm sure you've heard the term "networking" used to describe the process of finding an employer or employee by talking to friends and associates. In this case too, the idea is that independent units are connected together to share information and cooperate.

The widespread networking of personal computers is a relatively new phenomenon. For the first decade or so of their existence, PCs were very much "islands unto themselves", and were rarely connected together. In the early 1990s, PC networking began to grow in popularity as businesses realized the advantages that networking could provide. By the late 1990s, networking in homes with two or more PCs started to really take off as well.

This interconnection of small devices represents, in a way, a return to the "good old days" of mainframe computers. Before computers were small and personal, they were large and centralized machines that were shared by many users operating remote terminals. While having all of the computer power in one place had many disadvantages, one benefit was that all users were connected because they shared the central computer.

Individualized PCs took away that advantage, in favor of the benefits of independence. Networking attempts to move computing into the middle ground, providing PC users with the best of both worlds: the independence and flexibility of personal computers, and the connectivity and resource sharing of mainframes. In fact, networking is today considered so vital that it's hard to conceive of an organization with two or more computers that would not want to connect them together!

The Advantages (Benefits) of Networking

You have undoubtedly heard the "the whole is greater than the sum of its parts". This phrase describes networking very well, and explains why it has become so popular. A network isn't just a bunch of computers with wires running between them. Properly implemented, a network is a system that provides its users with unique capabilities, above and beyond what the individual machines and their software applications can provide.

Most of the benefits of networking can be divided into two generic categories: *connectivity* and *sharing*. Networks allow computers, and hence their users, to be connected together. They also allow for the easy sharing of information and resources, and cooperation between the devices in other ways. Since modern business depends so much on the intelligent flow and management of information, this tells you a lot about why networking is so valuable.

Here, in no particular order, are some of the specific advantages generally associated with networking:

-
- ④ **Connectivity and Communication:** Networks connect computers and the users of those computers. Individuals within a building or work group can be connected into *local area networks (LANs)*; LANs in distant locations can be interconnected into larger *wide area networks (WANs)*. Once connected, it is possible for network users to communicate with each other using technologies such as electronic mail. This makes the transmission of business (or non-business) information easier, more efficient and less expensive than it would be without the network.
 - ④ **Data Sharing:** One of the most important uses of networking is to allow the sharing of data. Before networking was common, an accounting employee who wanted to prepare a report for her manager would have to produce it on his PC, put it on a floppy disk, and then walk it over to the manager, who would transfer the data to her PC's hard disk. (This sort of “shoe-based network” was sometimes sarcastically called a “sneakernet”.)

True networking allows thousands of employees to share data much more easily and quickly than this. More so, it makes possible applications that rely on the ability of many people to access and share the same data, such as databases, group software development, and much more. [Intranets and extranets](#) can be used to distribute corporate information between sites and to business partners.

- ④ **Hardware Sharing:** Networks facilitate the sharing of hardware devices. For example, instead of giving each of 10 employees in a department an expensive color printer (or resorting to the “sneakernet” again), one printer can be placed on the network for everyone to share.
- ④ **Internet Access:** The Internet is itself an enormous network, so whenever you access the Internet, you are using a network. The significance of the Internet on modern society is hard to exaggerate, especially for those of us in technical fields.
- ④ **Internet Access Sharing:** Small computer networks allow multiple users to share a single Internet connection. Special hardware devices allow the bandwidth of the connection to be easily allocated to various individuals as they need it, and permit an organization to purchase one high-speed connection instead of many slower ones.
- ④ **Data Security and Management:** In a business environment, a network allows the administrators to much better manage the company's critical data. Instead of having this data spread over dozens or even hundreds of small computers in a haphazard fashion as their users create it, data can be centralized on shared servers. This makes it easy for everyone to find the data, makes it possible for the administrators to ensure that the data is regularly backed up, and also allows for the implementation of security measures to control who can read or change various pieces of critical information.
- ④ **Performance Enhancement and Balancing:** Under some circumstances, a network can be used to enhance the overall performance of some applications by distributing the computation tasks to various computers on the network.
- ④ **Entertainment:** Networks facilitate many types of games and entertainment. The Internet itself offers many sources of entertainment, of course. In addition, many multi-player games exist that operate over a local area network. Many home networks are set up for this reason, and gaming across wide area networks (including the Internet) has also become quite popular. Of course, if you are running a business and have easily-amused employees, you might insist that this is really a **disadvantage** of networking and not an advantage!



Key Concept: At a high level, networks are advantageous because they allow computers and people to be connected together, so they can share resources. Some of the specific benefits of networking include communication, data sharing, Internet access, data security and management, application performance enhancement, and entertainment.

Well, if that list isn't enough to convince you that networking is worthwhile, then... I have *no* idea what it is you do with your computers! ☺ At any rate, it's quite possible that only some of the above items will match your particular circumstances, but at least one will definitely apply to almost every situation, assuming you own or manage more than one computer.

The Disadvantages (Costs) of Networking

Now that I have portrayed the [great value and many useful benefits of networking](#), I must bring you crashing back to earth with that old nemesis of the realistic: TANSTAAFL. For those who are not Heinlein fans, this acronym stands for “There Ain’t No Such Thing As A Free Lunch”. Even though networking really does represent a “whole that is greater than the sum of its parts”, it does have some real and significant costs and drawbacks associated with it.

Here are a few of the items that balance against the advantages of networking.

- ☉ **Network Hardware, Software and Setup Costs:** Computers don't just magically network themselves, of course. Setting up a network requires an investment in hardware and software, as well as funds for planning, designing and implementing the network. For a home with a small network of two or three PCs, this is relatively inexpensive, possibly amounting to less than a hundred dollars with today's low prices for network hardware, and operating systems already designed for networks. For a large company, cost can easily run into tens of thousands of dollars—or more.
- ☉ **Hardware and Software Management and Administration Costs:** In all but the smallest of implementations, ongoing maintenance and management of the network requires the care and attention of an IT professional. In a smaller organization that already has a system administrator, a network may fall within this person's job responsibilities, but it will take time away from other tasks. In more substantial organizations, a network administrator may need to be hired, and in large companies an entire department may be necessary.
- ☉ **Undesirable Sharing:** With the good comes the bad; while networking allows the easy sharing of useful information, it also allows the sharing of undesirable data. One significant “sharing problem” in this regard has to do with viruses, which are easily spread over networks and the Internet. Mitigating these effects costs more time, money and administrative effort.

-
- ☉ **Illegal or Undesirable Behavior:** Similar to the point above, networking facilitates useful connectivity and communication, but also brings difficulties with it. Typical problems include abuse of company resources, distractions that reduce productivity, downloading of illegal or illicit materials, and even software piracy. In larger organizations, these issues must be managed through explicit policies and monitoring, which again, further increases management costs.
 - ☉ **Data Security Concerns:** If a network is implemented properly, it is possible to greatly improve the security of important data. In contrast, a poorly-secured network puts critical data at risk, exposing it to the potential problems associated with hackers, unauthorized access and even sabotage.

Most of these costs and potential problems can be managed; that's a big part of the job of those who set up and run networks. In the end, as with any other decision, whether to network or not is a matter of weighing the advantages against the disadvantages. Of course today, nearly everyone decides that networking *is* worthwhile.



Key Concept: Networking has a few drawbacks that balance against its many positive aspects. Setting up a network has costs in hardware, software, maintenance and administration. It is also necessary to manage a network to keep it running smoothly, and to address possible misuse or abuse. Data security also becomes a much bigger concern when computers are connected together.



Fundamental Network Characteristics

There are many different kinds of networks, and network technologies used to create them. The proliferation of networking methods has generally occurred for a very good reason: different needs require different solutions. The drawback of this is that there are so many different types of protocols and technologies for the networking student to understand! Before you can really compare these approaches, you need to understand some of the basic characteristics that make networks what they are. While network types may be quite dissimilar, they are often described and even contrasted on the basis of a number of common attributes.

In this section, I introduce and discuss a number of key networking concepts that describe and differentiate different types of networks and networking technologies. I also introduce and define a number of terms and “buzzwords” that you cannot avoid if you are going to learn about networks. The topics here include explanations of protocols, switching methods, types of network messages, message formatting, and ways of addressing messages. I also discuss the differences between client-server and peer-to-peer networking.



Note: If you have considerable experience in networking, you may not need to read everything in this section. I'd suggest scanning the headings of the various topics here; if you understand the terminology mentioned in a topic's title, you can probably feel pretty safe in skipping it.

Networking Layers, Models and Architectures

One of the reasons why many people find networking difficult to learn is that it can be a very complicated subject. One of the chief reasons for this complexity is that networks consist of so many hardware and software elements. While a network user may only perceive that he or she is using one computer program (like a Web browser) and one piece of hardware (like a PC), these are only parts of a much larger puzzle. In order for even the simplest task to be accomplished on a network, dozens of different components must cooperate, passing control information and data to accomplish the overall goal of network communication.

The best way to understand any complex system is to break it down into pieces and then analyze what they do and how they interact. The most logical approach for this is to divide the overall set of functions into modular components, each of which is responsible for a particular function. At the same time, we also need to define interfaces between these components, which describe how they fit together. This enables us to simplify the complexity of networking by approaching it in digestible chunks.

Networking Layers

Networking technologies are most often compartmentalized in this manner by dividing their functions into *layers*, each of which contains hardware and/or software elements. Each layer is responsible for performing a particular type of task, as well as interacting with the layers above it and below it. Layers are conceptually arranged into a vertical stack. Lower layers are charged with more concrete tasks such as hardware signaling and low-level communication; they provide services to the higher layers. The higher layers in turn use these services to implement more abstract functions such as implementing user applications.

Dividing networks into layers this way is somewhat like the division of labor in a manufacturing facility, and yields similar benefits. Each hardware device or software program can be specialized to perform the function needed by that layer, like a well-trained specialist on an assembly line. The different modules can be combined in different ways as needed. Understanding how a network functions overall is also made much easier this way.

Networking Models

One other important benefit of layering is that it makes it possible for technologies defined by different groups to interoperate. For this to be possible, it is necessary for everyone to agree on how layers will be defined and used. The most common tool for this purpose is a *networking model*. The model describes what the different layers are in the network, what each is responsible for doing, and how they interact. A universally-accepted model ensures that everyone is on the same page when creating hardware and software.

The most common general model in use today is the *Open Systems Interconnection (OSI) Reference Model*, which consists of seven stacked layers. These range from the Physical Layer (layer one) at the bottom, which is responsible for low-level signaling, to the Application Layer (layer seven) at the top, where application software is implemented. Understanding the OSI model is essential to understanding networking as a whole. I explain models and layers in more detail, as well as providing a complete description of the OSI Reference Model, in [its own dedicated section](#).

Networking Architectures

Closely related to the concept of a model is that of an *architecture*. An architecture is essentially a set of rules that describes the function of some portion of the hardware and software that constitute a stack of layers. Such a rule-set usually takes the form of a specification or standard that describes how equipment and programs using the technology must behave. A networking architecture is designed to implement the functions associated with a particular contiguous set of layers of the OSI Reference Model, either formally or informally.

In this Guide we are, of course, interested in the TCP/IP protocol suite, which runs the Internet, and a complex set of technologies that spans many layers of the OSI model. It is by examining the various components of TCP/IP and how they implement different OSI model layers that we will really learn how TCP/IP works. For starters, the name of the suite, TCP/IP, comes from the Transmission Control Protocol (TCP), which operates at layer four

of the OSI model, and the Internet Protocol (IP) that runs at OSI model layer three. IP provides services to layer four and uses services of layer two below it. TCP uses IP's functions and provides functions to the layers above it. The complete examination of TCP/IP starts by looking at [its architecture and a second, special model](#) that was developed specifically to make sense of TCP/IP.

Protocols: What Are They, Anyway?

If there's one word you will get used to seeing a lot as you go through this Guide, it is this one: *protocol*. You will see reference to networking protocols, internetworking protocols, high-level protocols, low-level protocols, protocol stacks, protocol suites, sub-protocols, and so on. Clearly protocols are important, yet many reference works and standards use the term over and over again without ever explaining it. One reason for this may be because the term is somewhat vague and can have many meanings, which can make it difficult to grasp.

The Meaning of the Word "Protocol"

In some cases, understanding a technical term is easier if we go back to look at how the term is used in plain English. In the real world, a protocol often refers to a code of conduct, or a form of etiquette observed by diplomats. These people must follow certain rules of ceremony and form to ensure that they communicate effectively, and without coming into conflict. They also must understand what is expected of them when they interact with representatives from other nations, to make sure that, for example, they do not offend due to unfamiliarity with local customs. Even we "normal people" follow protocols of various sorts, which are sort of the "unwritten rules of society".

This may seem to have little to do with networking, but in fact, this is a pretty good high-level description of what networking protocols are about. They define a language and a set of rules and procedures that enable devices and systems to communicate. Obviously, computers do not have "local customs", and they hardly have to worry about committing a "faux pas" that might cause another computer to take offense. What networking protocols concern themselves with is ensuring that all the devices on a network or internetwork are in agreement about how various actions must be performed in the total communication process.

So, a protocol is basically a way of ensuring that devices are able to talk to each other effectively. In most cases, an individual protocol describes how communication is accomplished between one particular software or hardware element in two or more devices. In the context of the [OSI Reference Model](#), a protocol is formally defined as a set of rules governing communication between entities at the same Reference Model layer. For example, the [Transmission Control Protocol \(TCP\)](#) is responsible for a specific set of functions on TCP/IP networks. Each host on a TCP/IP network has a TCP implementation, and they all communicate with each other logically at [layer four of the OSI model](#).

While OSI Reference Model definitions are sometimes overly theoretical in nature, this particular one is rather accurate in assessing protocols in real-world networking. If something doesn't specify a means of communication, it arguably isn't a protocol.



Key Concept: A *networking protocol* defines a set of rules, algorithms, messages and other mechanisms that enable software and hardware in networked devices to communicate effectively. A protocol usually describes a means for communication between corresponding entities at the same OSI Reference Model layer in two or more devices.



Related Information: The formalized OSI Reference Model meaning of the word “protocol” is covered in the [OSI model topic on horizontal layer communication](#).

Different Uses of the Word “Protocol”

Despite the strict OSI definition, the term “protocol” is often used colloquially to refer to many different concepts in networking. Some of the more common “alternative” uses of the word include the following:

- ☉ **Protocol Suites:** It is very common to hear the word “protocol” used to refer to sets of protocols that are more properly called *protocol suites* (or *stacks*, in reference to a stack of layers). For example, TCP/IP is often called just a “protocol” when it is really a (large) set of protocols.

Sometimes, the name of the technology itself leads to this confusion. The [Point-to-Point Protocol \(PPP\)](#), for example, is not one protocol; it contains many individual protocols that serve different functions and even have distinct message formats. Thus, PPP is really a protocol suite, or alternately, can be considered a protocol with “sub-protocols”.

- ☉ **Microsoft Windows Protocols:** One important example of the issue of referring to protocol suites as single protocols is the networking software in Microsoft Windows. It usually calls a full networking stack like [TCP/IP](#) or [IPX/SPX](#) just a “protocol”. When you install one of these “protocols”, however, you actually get a software module that supports a full protocol suite.
- ☉ **Other Technologies:** Sometimes technologies that are not protocols at all are called protocols, either out of convention or perhaps because people think it sounds good. For example, [TCP/IP Remote Network Monitoring \(RMON\)](#) is often called a protocol when it is really just an enhancement to the [Simple Network Management Protocol \(SNMP\)](#)—which is a protocol!

So, does it really matter whether a protocol is a “true” protocol or not? Well, the networking hardware devices and software programs sure don’t care. 😊 But hopefully having read about the term and what it means, you will be able to better understand the word when you encounter it in your studies—especially in the places where it may not always be used in a way entirely consistent with its formal definition.

Circuit Switching and Packet Switching Networks

In my “[grand overview](#)” of networking, I describe networks as devices that are connected together using special hardware and software, to allow them to exchange information. The most important word in that sentence is the final one: *information*. As you will see in your exploration of this Guide, there are many methods for exchanging information between networked devices. There are also a number of ways of categorizing and describing these methods and the types of networks that use them.

One fundamental way of differentiating networking technologies is on the basis of the method they use to determine the path between devices over which information will flow. In highly simplified terms, there are two approaches: either a path can be set up between the devices in advance, or the data can be sent as individual data elements over a variable path.

Circuit Switching

In this networking method, a connection called a *circuit* is set up between two devices, which is used for the whole communication. Information about the nature of the circuit is maintained by the network. The circuit may either be a fixed one that is always present, or it may be a circuit that is created on an as-needed basis. Even if many potential paths through intermediate devices may exist between the two devices communicating, only one will be used for any given dialog. This is illustrated in [Figure 1](#).

The classic example of a circuit-switched network is the telephone system. When you call someone and they answer, you establish a circuit connection and can pass data between you, in a steady stream if desired. That circuit functions the same way regardless of how many intermediate devices are used to carry your voice. You use it for as long as you need it, and then terminate the circuit. The next time you call, you get a new circuit, which may (probably will) use different hardware than the first circuit did, depending on what’s available at that time in the network.

Packet Switching

In this network type, no specific path is used for data transfer. Instead, the data is chopped up into small pieces called *packets* and sent over the network. The packets can be routed, combined or fragmented, as required to get them to their eventual destination. On the receiving end, the process is reversed—the data is read from the packets and re-

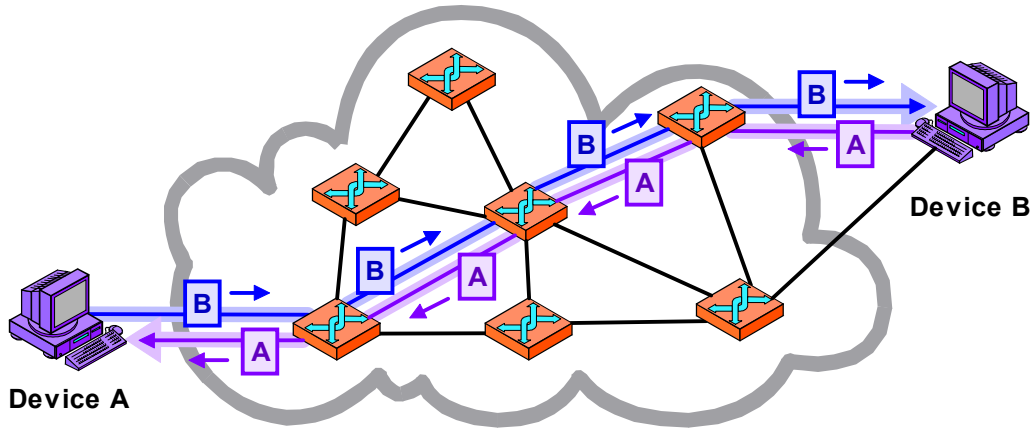

Figure 1: Circuit Switching

In a circuit-switched network, before communication can occur between two devices, a circuit is established between them. This is shown as a thick blue line for the conduit of data from Device A to Device B, and a matching purple line from B back to A. Once set up, all communication between these devices takes place over this circuit, even though there are other possible ways that data could conceivably be passed over the network of devices between them. Contrast this diagram to [Figure 2](#).

assembled into the form of the original data. A packet-switched network is more analogous to the postal system than it is to the telephone system (though the comparison isn't perfect.) An example is shown in [Figure 2](#).

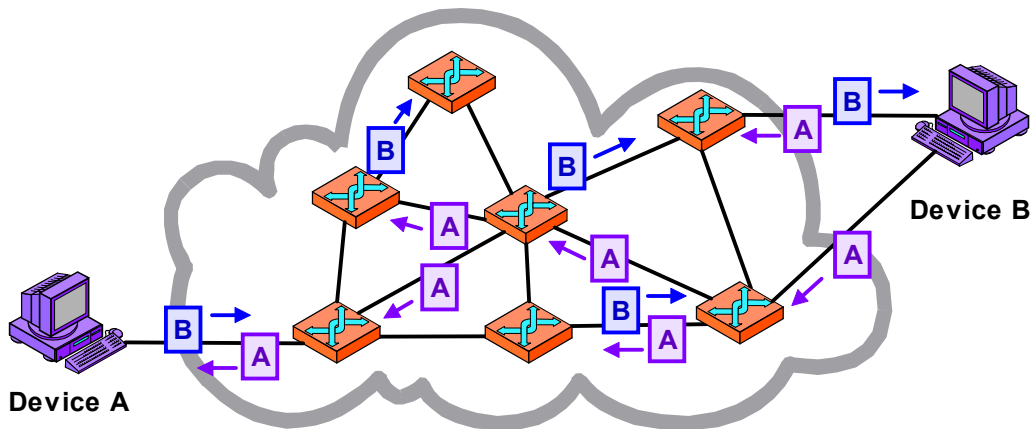

Figure 2: Packet Switching

In a packet-switched network, no circuit is set up prior to sending data between devices. Blocks of data, even from the same file or communication, may take any number of paths as it journeys from one device to another. Compare this to [Figure 1](#)



Key Concept: One way that networking technologies are categorized is based on the path used to carry data between devices. In *circuit switching*, a circuit is first established and then used to carry all data between devices. In *packet switching* no fixed path is created between devices that communicate; it is broken into packets, each of which may take a separate path from sender to recipient.

Comparing Circuit Switching and Packet Switching

A common temptation when considering alternatives such as these is to ask which is “better”—and as usually is the case, the answer is “neither”. There are places where one is more suited than the other, but if one were clearly superior, both methods wouldn't be used.

One important issue in selecting a switching method is whether the network medium is *shared* or *dedicated*. Your phone line can be used for establishing a circuit because you are the only one who can use it—assuming you can keep that pesky wife/husband/child/sister/brother/father/mother off the phone.

However, this doesn't work well in LANs, which typically use a single shared medium and baseband signaling. If two devices were to establish a connection, they would “lock out” all the other devices for a long period of time. It makes more sense to chop the data into small pieces and send them one at a time. Then, if two other devices want to communicate, *their* packets can be interspersed and everyone can share the network.

The ability to have many devices communicate simultaneously without dedicated data paths is one reason why packet switching is becoming predominant today. However, there are some disadvantages of packet switching compared to circuit switching. One is that since all data does not take the same, predictable path between devices, it is possible that some pieces of data may get lost in transit, or show up in the incorrect order. In some situations this does not matter, while in others it is very important indeed.

While the theoretical difference between circuit and packet switching is pretty clear-cut, understanding how they are used is a bit more complicated. One of the major issues is that in modern networks, they are often combined. For example, suppose you connect to the Internet using a dial-up modem. You will be using IP datagrams (packets) to carry higher-layer data, but it will be over the circuit-switched telephone network. Yet the data may be sent over the telephone system in digital packetized form. So in some ways, both circuit switching and packet switching are being used concurrently.

Another issue is the relationship between circuit and packet switching, and whether a technology is connection-oriented or connectionless. The two concepts are related but not the same; [the next topic](#) discusses this in much more detail.



Note: Note that the word “packet” is only one of several terms that are used to refer to messages that are sent over a network. Other terms you will encounter include [frame](#), [datagram](#), [cell](#) and [segment](#).

Connection-Oriented and Connectionless Protocols

In [the previous topic](#) I described and contrasted networking technologies based on whether or not they use a dedicated path, or *circuit*, over which to send data. Another way in which technologies and protocols are differentiated has to do with whether or not they use *connections* between devices. This issue is closely related to the matter of packet versus circuit switching.

Division of Protocols into Connection-Related Categories

Protocols are divided into two categories based on their use of connections:

- ☉ **Connection-Oriented Protocols:** These protocols require that a logical connection be established between two devices before transferring data. This is generally accomplished by following a specific set of rules that specify how a connection should be initiated, negotiated, managed and eventually terminated. Usually one device begins by sending a request to open a connection, and the other responds. They pass control information to determine if and how the connection should be set up. If this is successful, data is sent between the devices. When they are finished, the connection is broken.
- ☉ **Connectionless Protocols:** These protocols do not establish a connection between devices. As soon as a device has data to send to another, it just sends it.



Key Concept: A *connection-oriented* protocol is one where a logical connection is first established between devices prior to data being sent. In a *connectionless* protocol, data is just sent without a connection being created.

The Relationship Between Connection Orientation and Circuits

You can probably immediately see the relationship between the concepts of circuits and connections. Obviously, in order to establish a circuit between two devices, they must also be connected. For this reason, circuit-switched networks are inherently based on connections. This has led to the terms “circuit-switched” and “connection-oriented” being used interchangeably.

However, this is an oversimplification that results due to a common logical fallacy—people make the mistake of thinking that if A implies B, then B implies A, which is like saying that since all apples are fruit, then all fruit are apples. A connection is needed for a circuit, but a circuit is *not* a prerequisite for a connection. There are, therefore, protocols that are connection-oriented, while not being predicated on the use of circuit-based networks at all.

These connection-oriented protocols are important because they enable the implementation of applications that require connections, over packet-switched networks that have no inherent sense of a connection. For example, to use the TCP/IP [File Transfer Protocol](#), you want to be able to connect to a server, enter a login and password, and then execute commands to change directories, send or retrieve files, and so on. This requires the establishment of a connection over which commands, replies and data can be passed. Similarly, the [Telnet Protocol](#) obviously involves establishing a connection—it lets you remotely use another machine. Yet, both of these work (indirectly) over the IP protocol, which is based on the use of packets, through the principle of [layering](#).

To comprehend the way this works, one must have a basic understanding of the layered nature of modern networking architecture (as I discuss in some detail in [the chapter that talks about the OSI Reference Model](#)). Even though packets may be used at lower layers for the mechanics of sending data, a higher-layer protocol can create logical connections through the use of messages sent in those packets.



Key Concept: Circuit-switched networking technologies are inherently connection-oriented, but not all connection-oriented technologies use circuit switching. Logical connection-oriented protocols can in fact be implemented on top of packet switching networks to provide higher-layer services to applications that require connections.

Connection-Oriented and Connectionless Protocols in TCP/IP

Looking again at TCP/IP, it has two main protocols that operate at the [transport layer of the OSI Reference Model](#). One is the [Transmission Control Protocol \(TCP\)](#), which is connection-oriented; the other, the [User Datagram Protocol \(UDP\)](#), is connectionless. TCP is used for applications that require the establishment of connections (as well as TCP's other service features), such as FTP; it works using a set of rules, as described earlier, by which a logical connection is negotiated prior to sending data. UDP is used by other applications that don't need connections or other features, but do need the faster performance that UDP can offer by not needing to make such connections before sending data.

Some people consider this to be like a “simulation” of circuit-switching at higher network layers; this is perhaps a bit of a dubious analogy. Even though a TCP connection can be used to send data back and forth between devices, all that data is indeed still being sent as packets; there is no real circuit between the devices. This means that TCP must deal with all the potential pitfalls of packet-switched communication, such as the potential for data

loss or receipt of data pieces in the incorrect order. Certainly, the existence of connection-oriented protocols like TCP doesn't obviate the need for circuit switching technologies, though you will get some arguments about that one too. ☺

The principle of layering also means that there are other ways that connection-oriented and connectionless protocols can be combined at different levels of an internetwork. Just as a connection-oriented protocol can be implemented over an inherently connectionless protocol, the reverse is also true: a connectionless protocol can be implemented over a connection-oriented protocol at a lower level. In a preceding example, I talked about Telnet (which requires a connection) running over IP (which is connectionless). In turn, IP can run over a connection-oriented protocol like ATM.

Messages: Packets, Frames, Datagrams and Cells

Many networking technologies are based on [packet switching](#), which involves the creation of small chunks of data to be sent over a network. Even though the word “packet” appears in the name of this method, the data items sent between networked devices are most generically called *messages*. “Packet” is one of a variety of similar words that are used in different contexts to refer to messages sent from one device to another.

In some cases these different terms can be very useful; simply the type of name used for the message can tell you something about what the message contains. In particular, different message names are usually associated with protocols and technologies operating at specific layers of the [OSI Reference Model](#). Thus, the use of these different names can help clarify discussions that involve multiple protocols operating at different layers.

Unfortunately, these terms can also cause confusion, because they are not always applied in a universal or even consistent manner. Some people are strict about applying particular message designations only to the appropriate technologies where they are normally used, while others use the different terms completely interchangeably. This means that you should be familiar with the different message types and how they are normally used, but be prepared for the unexpected.

Common Names For Messages

The most common terms that are used for messages are the following:

- ☉ **Packet:** This term is considered by many to most correctly refer to a message sent by protocols operating at the [network layer](#) of the OSI Reference Model. So, you will commonly see people refer to “IP packets”. However, this term is commonly also used to refer generically to any type of message, as I mentioned at the start of this topic.
- ☉ **Datagram:** This term is basically synonymous with “packet” and is also used to refer to network layer technologies. It is also often used to refer to a message that is sent at a higher level of the OSI Reference Model (more often than “packet” is).

-
- ☉ **Frame:** This term is most commonly associated with messages that travel at low levels of the OSI Reference Model. In particular, it is most commonly seen used in reference to [data link layer](#) messages. It is occasionally also used to refer to [physical layer](#) messages, when message formatting is performed by a layer one technology. A frame gets its name from the fact that it is created by taking higher-level packets or datagrams and “framing” them with additional header information needed at the lower level.
 - ☉ **Cell:** Frames and packets, in general, can be of variable length, depending on their contents; in contrast, a *cell* is most often a message that is fixed in size. For example, the fixed-length, 53-byte messages sent in Asynchronous Transfer Mode (ATM) are called cells. Like frames, cells usually are used by technologies operating at the lower layers of the OSI model.
 - ☉ **Protocol Data Unit (PDU) and Service Data Unit (SDU):** These are the formal terms used in the OSI Reference to describe protocol messages. A PDU at layer N is a message sent between protocols at layer N. It consists of layer N header information and an encapsulated message from layer N+1, which is called both the *layer N SDU* and the *layer N+1 PDU*. After you stop scratching your head, see [the topic on OSI model data encapsulation](#) for a discussion of this that may actually make sense. ☺

I should also point out that there are certain protocols that use unusual names to refer to their messages, which aren’t used elsewhere in the world of networking. One prominent example is the [Transmission Control Protocol \(TCP\)](#), which calls its messages *segments*.



Key Concept: Communication between devices on packet-switched networks is based on in items most generically called *messages*. These pieces of information also go by other names such as *packets*, *datagrams*, *frames* and *cells*, which often correspond to protocols at particular layers of the OSI Reference Model. The formal OSI terms for messages are *protocol data unit (PDU)* and *service data unit (SDU)*.

Message Terminology in this Guide

As for this Guide and its use of these terms, I have made a specific effort not to imply anything about the nature of a message solely based on the name it uses, but I do try to follow the most common name used for a particular technology. For example, messages sent over Ethernet are almost always called Ethernet frames—they are not generally called Ethernet datagrams, for example. However, I do not structure discussions so that the type of name used for a message is the only way to determine what sort of message it is.

Message Formatting: Headers, Payloads and Footers

Messages are the structures used to send information over networks. They vary greatly from one protocol or technology to the next in how they are used, and as I described in [the previous topic](#), they are also called by many different names. Shakespeare had the right idea about names, however. The most important way that messages differ is not in what they are called but in terms of their *content*.

Every protocol uses a special *formatting method* that determines the structure of the messages it employs. Obviously, a message that is intended to connect a Web server and a Web browser is going to be quite different from one that connects two Ethernet cards at a low level. This is why I separately describe the formats of dozens of different protocol messages in various parts of this Guide.

Fundamental Message Elements

While the format of a particular message type depends entirely on the nature of the technology that uses it, messages on the whole tend to follow a fairly uniform overall structure. In generic terms, each message contains the following three basic elements (see [Figure 3](#)):

- **Header:** Information that is placed before the actual data. The header normally contains a small number of bytes of control information, which is used to communicate important facts about the data that the message contains and how it is to be interpreted and used. It serves as the communication and control link between protocol elements on different devices.
- **Data:** The actual data to be transmitted, often called the *payload* of the message (metaphorically borrowing a term from the space industry!) Most messages contain some data of one form or another, but some actually contain none: they are used only for control and communication purposes. For example, these may be used to set up or terminate a logical connection before data is sent.
- **Footer:** Information that is placed after the data. There is no real difference between the header and the footer, as both generally contain control fields. The term *trailer* is also sometimes used.

Since the header and footer can both contain control and information fields, you might rightly wonder what the point is of having a separate footer anyway. One reason is that some types of control information are calculated using the values of the data itself. In some cases, it is more efficient to perform this computation as the data payload is being sent, and then transmit the result after the payload in a footer. A good example of a field often found in a footer is redundancy data, such as a CRC code, that can be used for error detection by the receiving device. Footers are most often associated with lower-layer protocols, especially at the [data link layer](#) of the OSI Reference Model.

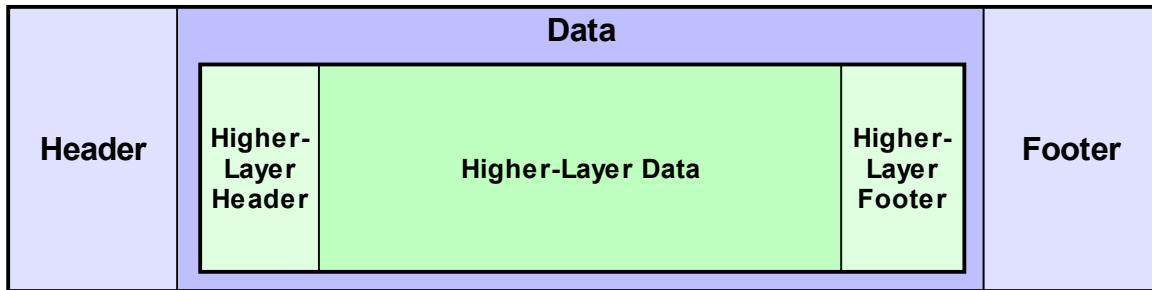

Figure 3: Network Message Formatting

In the most general of terms, a message consists of a *data payload* to be communicated, bracketed by a set of *header* and *footer* fields. The data of any particular message sent in a networking protocol will itself contain an encapsulated higher-layer message containing a header, data, and footer. This “nesting” can occur many times as data is passed down a protocol stack. The header is found in most protocol messages; the footer only in some.



Key Concept: The general format of a networking message consists of a *header*, followed by the *data* or *payload* of the message, followed optionally by a *footer*.

Header and footer information is functionally the same except for position in the message; footer fields are only sometimes used, especially in cases where the data in the field is calculated based on the values of the data being transmitted.

Interpretation of Message Elements

Generally speaking, any particular protocol is only concerned with its *own* header (and footer, if present). It doesn't care much about what is in the data portion of the message, just as a delivery person only worries about driving the truck and not so much on what it contains. At the beginning of that data will normally be the headers of other protocols that were used higher up in the protocol stack; this too is shown in [Figure 3](#). In the OSI Reference Model, a message handled by a particular protocol is said to be its *protocol data unit* or *PDU*; the data it carries in its payload is its *service data unit* or *SDU*. The SDU of a lower-layer protocol is usually a PDU of a higher-layer protocol. [The discussion of data encapsulation](#) contains a full explanation of this important concept.

Message Addressing and Transmission Methods: Unicast, Broadcast and Multicast Messages

In a networking technology that uses messages to send data, there are a number of tasks that must be undertaken in order to successfully transmit the data from one place to another. One is simply the *addressing* of the message—putting an address on it so that the system knows where it is supposed to go. Another is *transmitting* the message, which is of course sending it to its intended recipient.

There are several different ways of addressing and transmitting a message over a network. One way in which messages are differentiated is in how they are addressed, and to how many recipients. Which method is used depends on what the function of the message is, and also on whether or not the sender knows specifically whom they are trying to contact, or only generally.

Message Transmission Methods

To help explain these different methods, I will use a real-world analogy. Consider a social function with 300 people that is being held in a large hall. These people are mingling and are having different conversations. There are different kinds of messages that may need to be sent in this setting, much as is the case with networks.

Bearing this analogy in mind, consider these three kinds of message transmissions, which are illustrated in [Figure 4](#):

- ① **Unicast Messages:** These are messages that are sent from one device to another device; they are not intended for others. If you have a friend at this social event, this is the equivalent of pulling him or her aside for a private conversation. Of course, there is still the possibility of someone else at the event overhearing your conversation—or even eavesdropping on it. The same is true in networking as well—addressing a message to a particular computer doesn't guarantee that others won't also read it, just that they normally will not do so.
- ② **Broadcast Messages:** As the name suggests, these messages are sent to every device on a network. They are used when a piece of information actually needs communicating to everyone on the network, or used when the sending station needs to send to just one recipient, but doesn't know its address.

For example, suppose a new arrival at the social gathering saw a blue sedan with New Hampshire plates in the parking lot that had its lights left on. He of course does not know whose car this is. The best way to communicate this information is to broadcast it by having the host make an announcement that will be heard by all, including the vehicle's owner. In networks, broadcast messages are used for a variety of purposes, including finding the locations of particular stations or the devices that manage different services.

- ③ **Multicast Messages:** These are a compromise between the previous two types: they are sent to a group of stations that meet a particular set of criteria. These stations are usually related to each other in some way, such as serving a common function, or being set up into a particular *multicast group*. (Note that one can also consider broadcast messages to be a special case of multicast, where the group is “everyone”.)

Back to our analogy: this would be somewhat like a group of friends who go to this large social hall and then stay together in a small discussion group—or perhaps use radios to talk to each other from a distance. Multicasting requires special techniques that make clear who is in the intended group of recipients.

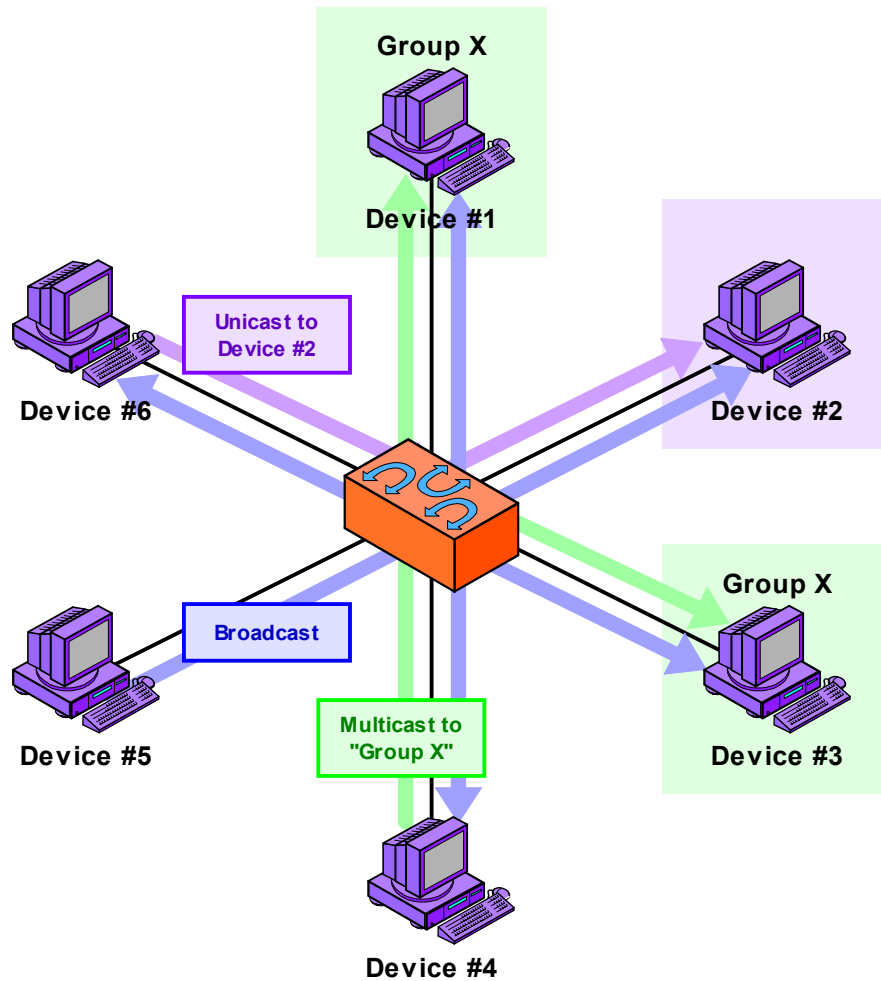

Figure 4: Unicast, Multicast and Broadcast Message Addressing and Transmission

The three basic type of addressing and message delivery in networking are illustrated in this simplified local area network. Device #6 is sending a *unicast* message to #2 shown in purple. Device #4 is sending a *multicast* message to multicast group “X”. In this case, that group includes devices #1 and #3, shown in green. Finally, Device #5 is sending a *broadcast* message, which goes to all other devices on the LAN.

Message Addressing Methods

Since the transmission methods above differ based on how many and which devices receive the transmission, they are tied directly to the methods used for addressing:

- ☉ **Unicast Addressing:** Unicast delivery requires that a message be addressed to a specific recipient. This is the most common type of messaging, so this addressing capability is present in almost all protocols.
- ☉ **Broadcast Addressing:** Broadcasts are normally implemented via a special address that is reserved for that function. Whenever devices see a message sent to that address, they all interprets it as meaning “this message goes to everyone”.

-
- ☉ **Multicast Addressing:** Multicasts are the most complex type of message because they require a means of identifying a set of specific devices to receive a message. It is often necessary to create several such groups, which may or may not partially overlap in their membership. Some mechanism is needed to manage which devices are in which groups.



Key Concept: Three basic methods are used to address and transmit data between networked devices. A *unicast* transmission goes from one device to exactly one other; this is the “normal” method used for most message transactions. A *broadcast* transmission is sent from one device to all connected devices on a network. A *multicast* transmission is addressed and sent to a select group of devices.



Note: A new type of message addressing method was defined as part of [IP version 6](#): the *anycast* message. This term identifies a message that should be sent to the closest member of a group of devices. [The topic on IPv6 multicast and anycast addressing](#) describes this type of addressing and transmission.

Finally, one special case in the field of addressing is worth mentioning. In some networks or links, only two devices are connected together, forming what is often called a *point-to-point network*. In this situation, everything sent by one device is implicitly intended for the other, and vice-versa. Thus, no addressing of messages on a point-to-point link is strictly necessary.

Network Structural Models and Client/Server and Peer-to-Peer Networking

I mentioned in [my discussion of the advantages of networking](#) that networks are normally set up for two primary purposes: *connectivity* and *sharing*. If you have a network with a number of different machines on it, each computer can interact with the hardware and software of the others, to enable a variety of tasks to be performed. How precisely this is done depends to a large degree on the overall design of the network.

Resource Sharing Roles and Structural Models

One very important issue in network design is how to configure the network for the sharing of resources. Specifically, the network designer must decide whether or not to dedicate resource management functions to the devices that constitute it. In some networks, all devices are treated equal in this regard, while in others, each computer is responsible for a particular job in the overall function of providing services. In this latter arrangement, the devices are sometimes said to have *roles*, somewhat like actors in a play.

Two common terms are used to describe these different approaches to setting up a network, sometimes called choosing a *structural model*.

Peer-to-Peer Networking

In a strict peer-to-peer networking setup, every computer is an equal, a *peer* in the network. Each machine can have resources that are shared with any other machine. There is no assigned role for any particular device, and each of the devices usually runs similar software. Any device can and will send requests to any other, as illustrated in [Figure 5](#).

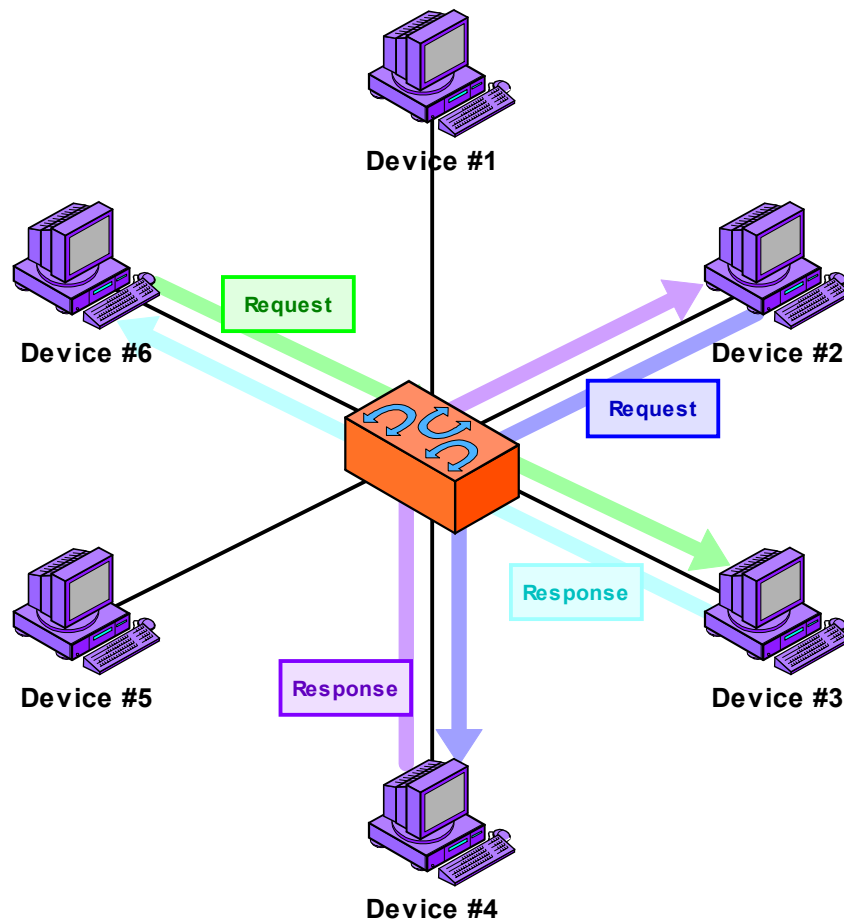

Figure 5: Peer-to-Peer Networking

In this model, each device on the network is treated as a peer, or equal. Each device can send requests and responses, and none are specifically designated as performing a particular role. This model is more often used in very small networks. Contrast to [Figure 6](#).

Client/Server Networking

In this design, a small number of computers are designated as centralized *servers* and given the task of providing services to a larger number of user machines called *clients*. The servers are usually powerful computers with a lot of memory and storage space, and fast network connections. The clients are typically smaller, “regular” computers like PCs, optimized for human use.

The term “client/server” also frequently refers to protocols and software, which are designed with matching, complementary components. Usually, server software runs on server hardware, and client software is used on client computers that connect to those servers. Most of the interaction on the network is between client and server, and not between clients, as shown in [Figure 6](#). Server software is designed to efficiently respond to requests, while client software provides the interface to the human users of the network.

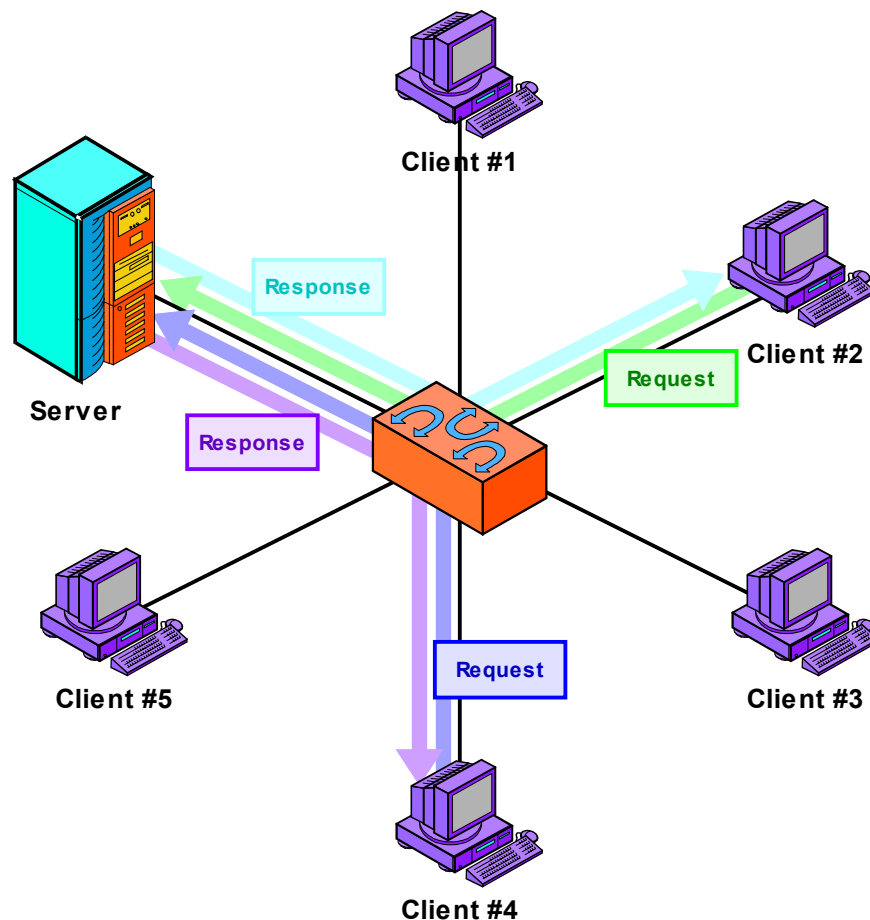

Figure 6: Client/Server Networking

In the client/server model, a small number of devices are designated as servers and equipped with special hardware and software that allows them to more efficiently interact simultaneously with multiple client machines. While the clients can still interact with each other, most of the time they send requests of various sorts to the server, and the server sends back responses to them. Contrast this to the peer-to-peer networking example in [Figure 5](#).



Key Concept: Networks are usually configured to share resources using one of two basic *structural models*. In a *peer-to-peer network*, each device is an equal and none are assigned particular jobs. In a *client/server network*, however, devices are assigned particular roles—a small number of powerful computers are set up as *servers* and respond to requests from the other devices, which are *clients*. Client/server computing also refers to the interaction between complementary protocol elements and software programs, and is rising in popularity due to its prevalence in TCP/IP and Internet applications.

Comparing Client/Server and Peer-to-Peer Networking

The choice of client/server or peer-to-peer is another where there is no “right answer” in this regard. Which should be used depends entirely on the needs of the particular network.

Peer-to-peer networking has primary advantages of simplicity and low cost, which means it has traditionally been used on small networks. Client/server networking provides advantages in the areas of performance, scalability, security and reliability, but is more complicated and expensive to set it up. This makes it better-suited to larger networks. Over time, however, there has been a steady evolution towards client/server networking, even on smaller networks. Many years ago it was common to see even networks with 20 to 50 machines using the peer-to-peer model; today, even networks with only a half-dozen machines sometimes are set up in a client/server mode because of the advantages of centralized resource serving.

The rise in popularity of client/server networking is ironic because in some ways, it is actually a throwback to the days of large mainframes decades ago. A mainframe with attached terminals can be thought of as a client/server network with the mainframe itself being the server and the terminals being clients. This analogy is not perfect, of course, because modern client computers do a lot more work than dumb terminals do on mainframes.

One of the reasons why the client/server structural model is becoming dominant is that it is the primary model used by the world’s largest network: the Internet. Client/server architecture is the basis for most TCP/IP protocols and services. For example, the term “Web browser” is really another name for a “Web client”, and a “Web site” is really a “Web server”.



Related Information: For more information on client/server computing, I recommend you read [the topic devoted to TCP/IP client/server operation](#). That topic also contains a very relevant exposition on the different meanings of the terms “client” and “server” in hardware, software and transactional contexts.



Types and Sizes of Networks

One of the reasons that understanding networks can be difficult at times is that there are so many different types! When someone talks about a “network”, this can mean anything from two computers hooked together in an apartment to a globe-spanning entity with millions of nodes. Every network is unique, and each one has an important role to play in filling the communication and data-sharing needs of different individuals and organizations. In fact, the great diversity and flexibility of networking is one of its most important strengths.

In this section I describe the major types of networks that exist by drawing distinctions between them based on their size and scope, and show how each type and size is used. I begin with a discussion of LANs, WLANs and WANs, and a few variations on these three main categories. I explore the many terms that are related to the various sizes of networks and how they are used, including segments, subnetworks, internetworks, intranets and extranets



Note: As with other networking fundamentals discussions, if you have some background or experience in networking, you may not need to read everything in this section. I'd suggest scanning the headings of the various topics here to get a handle for what you feel you need to read.

Local Area Networks (LANs), Wireless LANs (WLANs) and Wide Area Networks (WANs) and Variants (CANs, MANs and PANs)

Two of the most basic ways that networks are differentiated and contrasted are the relative distances between the devices that they connect, and the general mechanisms used to communicate between them. The reason for making these distinctions is that the technological needs of a network differ greatly depending on the amount of ground you are trying to cover, and also on the overall way that you want to transmit and receive information.

Fundamental Network Classifications

Many people, including me, like to divide the many kinds of networks in existence into three general classes:

- ① **Local Area Networks (LANs):** Networks that connect together computers that are relatively close to each other—generally, within the same room or building. When most people think about networking PCs and other small computers, this is what they usually have in mind. The vast majority of regular LANs connect using cables, so the term “LAN” by itself usually implies a wired LAN, but not always.

-
- ④ **Wireless Local Area Networks (Wireless LANs or WLANs):** Local area networks that connect devices without wires, using radio frequencies or light. WLANs can be entirely wireless, but most are not: they usually connect wireless devices to each other and also to the wired portion of the network. Due to the limits of most wireless technologies, wireless LANs usually connect devices that are very close to each other, generally within a few hundred feet at most.
 - ④ **Wide Area Networks (WANs):** Networks that connect together devices or other networks over a greater distance than is practical for local area networking. If the distance between devices can be measured in miles, you will generally use WAN and not LAN technology to link them.

More often than not, WANs are used to link together physically distant LANs. For example, a company with locations in two different cities would normally set up a LAN in each building and then connect them together in a WAN. I also consider most Internet access technologies to be a form of wide area networking, though some might not agree with that. There is also the term *wireless WAN (WWAN)*, which just refers to a WAN that uses wireless technology.

Difficulties in Categorizing Network Classes

As with most other distinctions and categorizations in the world of networking, the lines between these various definitions are not very concrete. As I mentioned already, wireless LANs are usually not entirely wireless, because they contained wired elements. Similarly, trying to say absolutely when a network is “local” and when it is “wide” is difficult.

It's also somewhat pointless to spend too much energy on differentiating these network classes precisely. In some cases it's not the definitions that decide what technology to use, but rather the technology that indicates what kind of network you have! Since some protocols are designed for wide area networking, if you are using them, many would say you have a WAN, even if all the devices in that technology are near each other. On the other hand, some LAN technologies allow the use of cables that can run for many miles; most would still consider a mile-long Ethernet fiber link to be a LAN connection, even though it may span WAN distances.

There are many dimensions in which local and wide area networking technologies differ; two of the most important are *cost* and *performance*. It's easy to establish a high-speed conduit for data between two systems that are in the same room; much more difficult if the two are in different states. This means that in the world of WAN, one either pays a lot more or gets a lot less throughput—and often both.

"Intermediate" Network Types

The blurry line between LAN and WAN is becoming more muddled every years. One reason is the emergence of “intermediate” network types that straddle the line between these more familiar terms.

-
- ☉ **Campus Area Networks (CANs):** A *campus area network (CAN)* is one created to span multiple buildings in the same location, such as the campus of a university. Campus area networking is a “gray area”, since neither LANs nor WANs alone are always well-suited for this type of application. Often, a mix of LAN and WAN techniques are used for campus networking, depending on the characteristics of the campus and the needs of the organization.
 - ☉ **Metropolitan Area Networks (MANs):** Another “intermediate” term that you may see sometimes is the *metropolitan area network* or *MAN*. As the name implies, this refers to a network that spans a particular small region or a city. Metropolitan area networks can be considered either as “small WANs” that cover a limited geographical area, or as “large LANs” that cover an area greater than that normally associated with a local network. Wireless metropolitan area networks are of course sometimes called *WMANs*; IEEE 802.16 is an example of a WMAN standard.

Personal Area Networks (PANs)

Finally, there is one other term occasionally used that should be mentioned: the *personal area network (PAN)*. This type of network generally means a very small LAN with a range of only a few feet, intended mostly to connect together devices used by a single person (or very small group). The term is most commonly used in reference to Bluetooth / IEEE 802.15 wireless technology, so you will sometimes see the terms *wireless personal area network (WPAN)* and just *PAN* used interchangeably.



Key Concept: Networks are often divided by size and general communication method into three classes. *Local area networks (LANs)* generally connect together proximate devices, usually using cables. *Wireless LANs (WLANs)* are like cabled LANs but use radio frequency or light technology to connect devices without wires. *Wide area networks (WANs)* connect distant devices or LANs to each other. *Campus area networks (CANs)* and *metropolitan area networks (MANs)* fall between *LANs* and *WANs* in terms of overall size; *personal area networks (PANs)* are like very small LANs and often appear as *wireless PANs (WPANs)*.

Segments, Networks, Subnetworks and Internetworks

One of the reasons that networks are so powerful is that they can not only be used to connect computers together, but to connect groups of computers together. Thus, network connections can exist at multiple levels; one network can be attached to another network, and that entire whole can be attached to another set of networks, and so on. The ultimate example of this is, of course, the Internet, a huge collection of networks that have been interconnected into... dare I say a “Web”? ☺

This means a larger network can be described as consisting of several smaller networks or even parts of networks that are linked together. Conversely, we can talk about taking individual networks or network portions and assembling them into larger structures. The

reason why this concept is important is that certain technologies are best explained when looking at an entire large network at a high level, while others really require that we drill down to the detailed level of how constituent network pieces work.

Common Terms Describing the Size of Networks

Over time, a collection of terms has evolved in the networking world to describe the relative sizes of larger and smaller networks. Understanding these different terms is important not only for helping you comprehend what you read about networks, but also because they are important concepts in network design. This is particularly true for local area networking, where decisions regarding how to set up segments and how to connect them to each other have an important impact on the overall performance and usability of the network. Here are some of the most common ones.

Network

This is the least specific of the terms mentioned here. Basically, a network can be of pretty much any size, from two devices to thousands. When networks get very large, however, and are clearly comprised of smaller networks connected together, they are often no longer called networks but internetworks, as we will see momentarily. Despite this, it is fairly common to hear someone refer to something like “Microsoft’s corporate network”, which obviously contains thousands or even tens of thousands of machines.

Subnetwork (Subnet)

A subnetwork is a portion of a network, or a network that is part of a larger internetwork. This term is also a rather subjective one; subnetworks can in fact be rather large when they are part of a network that is very large.

The abbreviated term “subnet” can refer generically to a subnetwork, but also has a [specific meaning in the context of TCP/IP addressing](#).

Segment (Network Segment)

A segment is a small section of a network. In some contexts, a segment is the same as a subnetwork and the terms are used interchangeably. More often, however, the term “segment” implies something smaller than a subnetwork. Networks are often designed so that, for the sake of efficiency, with computers that are related to each other or that are used by the same groups of people put on the same network segment.

This term is notably problematic because it is routinely used in two different ways, especially in discussions related to Ethernet. The earliest forms of Ethernet used coaxial cables, and the coax cable itself was called a “segment”. The segment was shared by all devices connected to it, and became the *collision domain* for the network (a phrase referring generally to a collection of hardware devices where only one can transmit at a time.)

Each Ethernet physical layer had specific rules about how many devices could be on a segment, how many segments could be connected together, and so on, depending on what sort of network interconnection devices were being used. Devices such as hubs and repeaters were used to extend collision domains by connecting together these segments of cable into wider networks. Over time, the terms “collision domain” and “segment” started to be used interchangeably. Thus today a “segment” can refer either to a specific piece of cable, or to a collection of cables connected electrically that represent a single collision domain.



Note: As if that potential ambiguity in the use of the word “segment” isn’t bad enough, it also has another, totally unrelated meaning: it is the name of [the messages sent in the Transmission Control Protocol!](#)

Internetwork (or Internet)

Most often, this refers to a larger networking structure that is formed by connecting together smaller ones. Again, the term can have either a generic or a specific meaning, depending on context. In some technologies, an internetwork is just a very large network that has networks as components. In others, a network is differentiated from an internetwork based on how the devices are connected together.

An important example of the latter definition is TCP/IP, where a network usually refers to a collection of machines that are linked at [layer two of the OSI Reference Model](#), using technologies like Ethernet or Token Ring and interconnection devices such as hubs and switches. An internetwork is formed when these networks are linked together at [layer three](#), using routers that pass Internet Protocol datagrams between networks. Naturally, this is highly simplified, but in studying TCP/IP you should keep this in mind when you encounter the terms “network” and “internetwork”.



Note: The shorter form of the word internetwork (“internet”) is often avoided by people who wish to avoid confusion with the proper noun form (“The Internet”). The latter of course refers only to the [well-known global internetwork of computers](#) and all the services it provides. I personally try to use the word “internetwork” most of the time in this Guide instead of “internet”, for this very reason.



Key Concept: Several terms are often used to describe the relative sizes of networks and parts of networks. The most basic term is *network* itself, which can refer to most anything, but often means a set of devices connected using an OSI layer two technology. A *subnetwork* is a part of a network (or internetwork), as is a *segment*, though the latter often has a more specific meaning in certain technologies. An *internetwork* refers either generically to a very large network, or specifically to a set of layer-two networks connected using routers at layer three.

The Internet, Intranets and Extranets

I mentioned in [the topic discussing segments, networks, subnetworks and internetworks](#) that the Internet is really the king of internetworks. After all, you don't get to be called "the" something unless you pretty much define it.

In fact, the Internet is not just a large internetwork, but substantially more. The Internet is defined not just as the computers that are connected to each other around the world, but as the set of services and features that it offers. More than that, the Internet defines a specific way of doing things, of sharing information and resources between people and companies. And though it might be a bit melodramatic to say so, to many people the Internet is a way of life. As Internet use and popularity exploded in the 1990s, many people realized that the techniques and technologies used on the Internet would be useful if applied to internal company networks as well. The term *intranet* was coined to refer to an internal network that functioned like a "private Internet". It comes from the prefix "intra", which means "within". Of course, "inter" is the opposite of "intra", so this makes some people think that an "intranet" is the opposite of an "internet". In fact, most intranets **are** internetworks as well!

As if that weren't bad enough from a jargon standpoint, the buzzword buzzards then decided to take matters a step further. If an intranet is "extended" to allow access to it not only strictly from within the organization, but also by people or groups outside the main company, this is sometimes called an *extranet*. "Extra" of course, is a prefix that means "outside" or "beyond".

So, an extranet is a type of internal, private Internet that, uh, well, isn't entirely internal. An extranet is an extended intranet, which is really a type of internet that works like the Internet. (You can start to see why I am not a big fan of these fancy terms. But then, I don't get to choose them; I just have to help you understand them!) An extranet isn't public and open to all—it is controlled by a private organization. At the same time, it isn't entirely private either.

As you can see, the lines between the Internet, intranets and extranets were pretty blurry from the start, and the concepts are rapidly blending into a diffuse mass of gray, as the whole computing world becomes more tightly integrated. For example, even if you have an entirely private intranet, you will want to connect it to the Internet to communicate with the

“outside world” and to allow access to Internet resources. And an extranet may be implemented, in part, through the public Internet infrastructure, using technologies such as virtual private networking (VPN). I think you get the picture.

The key that binds all of these concepts together is that they all use “Internet technologies”, a term that is itself somewhat vague. This usually refers to the use of the [TCP/IP protocol suite](#), which is the defining technology of the Internet, as well as the set of services that are available on the Internet.

The bottom line is that being told that a company has an “intranet” or an “extranet”—as opposed to a plain old boring “network”—doesn’t tell you much at all. It is best not to rely on the slogans and instead look at the underlying characteristics of the network or internetwork itself. Furthermore, when designing such a network, focus on using the technologies and protocols that make sense—let the marketing people decide what to call it later. 😊



Key Concept: The generic noun *internet* is a short form for the word *internetwork*, while the proper noun *Internet* refers to the global internetwork of TCP/IP networks we all know and use. The term *intranet* refers to an internal network that uses TCP/IP technologies like the Internet does. An *extranet* is like an intranet that is extended to individuals or organizations outside the company. All these terms can be used ambiguously, so care must be taken in determining exactly what they mean in any given context.



Network Performance Issues and Concepts

Networking is largely about connecting together devices so that information can be shared between them. Since the idea is to send data from one place to another, a very important characteristic of any network is its *speed*: how fast can data be transmitted and received? This matter of speed turns out to be only one of several issues that determine the overall *performance* of a network. The issue is complex enough that I decided a section was warranted to introduce the various related topics and help you understand how to look at network performance in a balanced way. When it comes to network performance, there's a *lot* of hype out there!

In the computing world, performance is, in general, one of the most often discussed but least well-understood characteristics of any system or hardware device. This is true of networking as well. For example, most people know the raw throughput rating of their network hardware, and may even start to draw conclusions about its capabilities based on those numbers. Many, however, don't realize that they will never actually achieve that "rated" amount of performance in the real world.

Most of the other "subtle" issues related to performance are also typically ignored or misunderstood, such as the impact of software drivers on hardware performance, and the fact that certain applications need more than just raw bit speed—they need *reliable* delivery of data. But even beyond all of this, one of the most important issues related to network performance is understanding what your needs are, to make sure you don't spend too much money for performance you don't need—or worse, create a network that can't meet your requirements.

In this section, I discuss various performance issues and concepts that are related to networking in one way or another. First and foremost, I try to put performance in context, and also contrast it with non-performance issues. Then, I talk about several key performance terms and metrics: speed, bandwidth, throughput and latency. I also talk about some of the units used to measure network performance. I then explain how the real-world performance of a network differs from its theoretical performance, and talk about factors that have an impact on network performance. I conclude by contrasting full-duplex and half-duplex network operation, and talking about quality of service, a concept that is especially important in the use of networks for real-time applications such as streaming multimedia.

Putting Network Performance In Perspective

Performance is probably the "mother of all buzzwords" in the computer industry. There are many people who consider it the ultimate goal of any computer or computer system, and by extension, any network. A lot of people spend many dollars and hours of time trying to maximize it. There's good reason for this: performance *is* very important. A network that does not offer adequate performance simply will not get the job done for those that rely on

it. However, it is very important to keep performance in perspective. Successfully maximizing performance requires that you first take a step back and look at the issue in a big picture way.

The first question you must ask yourself is also the most essential one: how important is performance to you? Before you answer this question, recall the old auto racing adage: “speed costs money—how fast do you want to go?” While there are some situations where you can get much better performance in a network by spending just a little more money, in general, you don't get more performance without paying for it in some way. That may mean more dollar cost for the network, or it may mean a trade-off of some non-performance characteristic.

If you are designing or specifying a network, it's very important to keep in mind that your goal is to come up with a system that will meet the needs that were determined for it during requirements analysis. This means coming up with a network that has a level of performance that matches the requirements, and of course leaves some room for expansion. Unless you have an unlimited budget—and who does?—your objective is not “performance at any cost”. It is to create a network that meets *all* of your users' needs, including [balancing performance and non-performance characteristics](#).

A primary reason why I make a point of trying to keep performance in perspective is that so many others do not—especially those who are trying to sell you things. Companies are constantly coming out with the “latest and greatest” high-performance networking technologies. The usual way that they try to sell them is by attempting to convince everyone that they just cannot live without this latest advance; that they “need” to upgrade—immediately, if not sooner! Well, it's simply not the case. As just one example, even though Ethernet hardware now exists that runs with a theoretical throughput of 10,000 megabits per second, there are many older networks that continue to work just fine at a hundredth that speed—or even a thousandth!

Finally, remember that designing a network is usually not an “irreversible”, permanent decision. Networks can be upgraded and expanded. While it is prudent to build some “slack” into any network to allow for growth, it is not wise to spend too much on planning for the future when changes can be made later. This is especially true given that network hardware prices drop over time. Again here, this is a matter of drawing an appropriate balance between future performance planning and budget.

Balancing Network Performance with Key Non-Performance Characteristics

We all know that performance is very important to any network. However, anyone putting together a network must also be concerned with many different non-performance characteristics as well. Depending on the network, these can be just as essential to the users of the network as performance, and possibly even more critical. More than this, non-performance issues often *trade off* against performance, and in fact, often more than not one has to be reduced to get performance to increase.

So, if you want to create a very-high-performance network, you need to understand the key non-performance network characteristics where you may need to compromise. Here are a few of these issues, and specifically how they relate to performance concerns:

- ④ **Design and Implementation Cost:** Unless you have bottomless pockets, you need to be concerned with the network's costs. As mentioned in [the prior topic](#), cost is the main trade-off with performance. Going faster costs more money—not always, but usually.
- ④ **Quality:** The quality of the network is a function of the quality of the components used and how they are installed. Quality is important because of its impact on all of the factors described here, such as reliability and ease of administration, as well as performance. Quality doesn't trade off **directly** with performance—you can design high-quality, high-performance networks—but it does **compete** with performance for resources such as budget. All else being equal, it costs a great deal more to implement a high-quality, high-performance network than a high-quality, low-speed one.
- ④ **Standardization:** Network protocols and hardware can either be designed to meet universally-accepted standards, or non-standard, proprietary ones. Standard designs are almost always preferable, as they make interoperability, upgrading, support and training easier. Proprietary standards may include enhancements that improve performance, but may increase cost and/or make management more difficult.
- ④ **Reliability:** This is related to several other issues, especially quality and performance. Faster networks aren't necessarily less reliable, but it's more difficult and expensive to run them as reliably as slower ones.
- ④ **Expandability and Upgradability:** It's very important to always plan for the future when creating a network. Higher-performance networks can be more difficult to expand; they are certainly more expensive to expand. Once again, the matter of implementing a network with capacity for future needs now, as opposed to upgrading later if it becomes necessary, is an important network design decision.
- ④ **Ease of Administration and Maintenance:** Higher-performance networks require more work and resources to administer and maintain, and are more likely to require troubleshooting, than slower ones.
- ④ **Premises and Utility Issues:** Implementation of high-speed networks may be limited by the physical premises, or may have an impact on how they are laid out. Choosing a higher-speed option may require more infrastructure to be put in place, increasing cost. The classic example of this is seen in choosing between wired and wireless options for a home or small office network: with wires you can go much faster, but do you really want to run the wires?

Anyway, now you have a flavor of how performance balances against some of the other key issues in networking. The idea of this topic wasn't to convince you not to build a high-performance network, just to let you know part of the price you will pay.



Key Concept: While performance is one of the most important characteristics of any network, there are others that are equally important. In many cases, the cost, quality, reliability, expandability, maintainability and other attributes of a network may in fact trade off against overall performance. The faster you want your network to go, the more difficult it is to ensure these other attributes are kept at sufficiently high levels.

Performance Measurements: Speed, Bandwidth, Throughput and Latency

There are a number of terms that are commonly used to refer to various aspects of network performance. Some of them are quite similar to each other, and you will often see them used—and in many cases, misused or even **abused**. ☺ It's a good idea for us to take a look at each of them, therefore, discuss how they are commonly used and what they really mean.

More than just the issue of different terms related to performance, however, is the more important reality that there are multiple **facets** to performance. Depending on the application, the manner in which data is sent across the network may be more important than the raw speed at which it is transported. In particular, many multimedia applications require real-time performance; they need data sent in such a manner that it will be delivered steadily. For these purposes, raw speed isn't as important as **consistent** speed, and this is an issue that is often not properly recognized.

Performance Measurement Terms

Let's take a look at the most common performance measurement terms and see what they are all about.

Speed

This is the most generic performance term used in networking. As such, it can mean just about **anything**. Most commonly, however, it refers to the *rated* or *nominal* speed of a particular networking technology. For example, Fast Ethernet has a nominal speed of 100 megabits per second; it is for that reason often called 100 Mbit Ethernet, or given a designation such as “100BASE-TX”.

Rated speed is the biggest “performance magic number” in networking—you see it used to label hardware devices, and many people bandy the numbers about as if they actually were the real “speed of the network”. The problem with using nominal speed ratings is that they are *theoretical* only, and as such, tell an incomplete story. No networking technology can run at its full rated speed, and many run **substantially** below it, due to [real-world performance factors](#).

Speed ratings such as “100 Mbps Ethernet” are also often referred to as the “throughput” of a technology, even though the maximum theoretical speed of a technology is more analogous to bandwidth than throughput, and the two are not identical. More on this in the next two bullet points.

Bandwidth

Bandwidth is a widely-used term that usually refers to the data-carrying capacity of a network or data transmission medium. It indicates the maximum amount of data that can pass from one point to another in a unit of time. The term comes from the study of electromagnetic radiation, where it refers to the width of a band of frequencies used to carry data. It is usually given in a theoretical context, though not always.

Bandwidth is still used in these two senses: “frequency band width” and data capacity. For example, radio frequencies are used for wireless technologies, and the bandwidth of such technologies can refer to how wide the RF band is. More commonly, though, it refers to how much data can be sent down a network, and is often used in relative terms. For example, for Internet access, a cable or xDSL is considered “high bandwidth” access; using a regular analog modem is “low bandwidth”.

Throughput

Throughput is a measure of how much actual data can be sent per unit of time across a network, channel or interface. While throughput can be a theoretical term like bandwidth, it is more often used in a practical sense, for example, to measure the amount of data actually sent across a network in the “real world”. Throughput is limited by bandwidth, or by rated speed: if an Ethernet network is rated at 100 megabits per second, that's the absolute upper limit on throughput, even though you will normally get quite a bit less. So, you may see someone say that they are using 100 Mbps Ethernet but getting throughput of say, 71.9 Mbps on their network.

The terms bandwidth and throughput are often used interchangeably, even though they are really not exactly the same, as I just discussed.



Key Concept: The three terms used most often to refer to the overall performance of a network are *speed*, *bandwidth*, and *throughput*. These are related and often used interchangeably, but are not identical. The term *speed* is the most generic and often refers to the rated or nominal speed of a networking technology. *Bandwidth* can refer either to the width of a frequency band used by a technology, or more generally to data capacity, where it is more of a theoretical measure. *Throughput* is a specific measure of how much data flows over a channel in a given period of time. It is usually a practical measurement.

Latency

This very important, often overlooked term, refers to the *timing* of data transfers on a communications channel or network. One important aspect of latency is how long it takes from the time a request for data is made until it starts to arrive. Another aspect is how much control a device has over the timing of the data that is sent, and whether the network can be arranged to allow for the consistent delivery of data over a period of time. Low latency is considered better than high latency.

Applying Performance Measurement Terms

As with all networking terms, there are no hard and fast rules; many people are rather loose with their use of the terms above. You will even see terms such as “throughput bandwidth”, “bandwidth throughput” and other charming inventions from the department of redundancy department. ☺ More often, you will just see a lot of mish-mashed term usage, and especially, spurious conclusions being drawn about what data streams a network can handle based on its rated speed. Making matters worse is that speed ratings are usually specified in bits per second, but throughput may be given in bits or bytes per second.

In general, “speed”, bandwidth and throughput get a lot of attention, while latency gets little. Yet latency considerations are very important for many real-time applications such as streaming audio and video and interactive gaming. In fact, they are often more important than raw bandwidth.

For example, suppose you move to a rural home and your choices for Internet access are a regular 28.8 kbps modem connection or fancy satellite Internet. The companies selling satellite connectivity call it “broadband” and advertise very high rated speeds—400 kbps or more. They make a big deal about it being “over 10 times as fast as dialup” and they certainly charge a lot for this very high-tech service. This is a slam dunk, right?

Wrong. The satellite connection has high bandwidth, but very poor (high) latency due to the time it takes for the signals to travel to and from the satellite. It is definitely much better than the modem for downloading that nice little 150 MB patch from Microsoft. However, it is much **worse** than the modem for playing the latest online video game with your buddy over the Internet, because of the latency, or *lag*, in transmissions. Every move you make in your game will be delayed for over half a second as the signal bounces around between the satellite and the earth, making online gaming nearly impossible. Thus, whether satellite Internet is worth the extra money depends entirely on what you plan to use it for.



Related Information: An important issue closely related to latency is quality of service, a general term that refers (among other things) to the ability of networks to deliver necessary bandwidth and reliable data transfer for applications that need it. [See the topic devoted to this subject later in this section.](#)



Key Concept: Where bandwidth and throughput indicate how fast data moves across a network, *latency* describes the nature of how it is conveyed. It is most often used to describe the delay between the time that data is requested and the time when it arrives. A networking technology with very high throughput and bad (high) latency can be worse for some applications than one with relatively low throughput but good (low) latency.

Understanding Performance Measurement Units

People who make networking hardware, or write materials that try to tell you how to operate it, make use of many terms to describe performance, such as [throughput and bandwidth](#). In addition, they also use several different *units* to measure performance. Unfortunately—and I'm sure you knew this was coming—these units are often used incorrectly, and they are also very similar to each other in name. Worse, they also have overlapping abbreviations, and lots of people use these abbreviations without making clear what the heck they are talking about. Isn't that great?

“Bits and Bytes”

The first issue is “the infamous letter B”. Or rather, I should say, the matter of the “big B” and the “little b”. By popular convention, the capitalized “B” is supposed to be used for “byte”, and the lower-case “b” for bit—this is the way these abbreviations are always used in this Guide. (A byte is normally eight bits; sometimes the term *octet* is used instead. If you aren't familiar with these terms, refer to [the primer on binary basics](#), where you will also find a discussion of the small “controversy” related to bytes and octets.)

Unfortunately, this convention is not followed strictly by everyone. As a result, you may on occasion see “b” being used to refer to bytes, and “B” used for bits. This “b” and “B” business causes a tremendous amount of confusion sometimes, with people mistaking bits for bytes and accidentally thinking that networks are running eight times faster or slower than they really are.

Bear in mind when looking at speed ratings that they are almost always given in terms of bits, not bytes. The “56k” in a “56k modem” means 56,000 bits, not 56,000 bytes, of theoretical transfer speed. (This is true even if someone calls it a “56K” modem.) Similarly, Fast Ethernet operates at 100 megabits per second, not megabytes, and a 1.544 Mbps T-1 link sends a theoretical maximum of 1,544,000 bits each second. This, at least, is usually pretty consistent.

When it comes to throughput measurements, however, both bits and bytes are used, so you have to be careful. Raw throughput values are normally given in bits per second, but many software applications report transfer rates in bytes per second, including many Web browsers and FTP client programs. This often leads to users wondering why they are only getting one eighth of their expected download or transfer speeds.



Key Concept: In most cases in discussions of networking performance, the lower-case letter “b” refers to “bits” and the upper-case “B” to “bytes”. However, these conventions are not always universally followed, so context must be used to interpret a particular measurement.

Throughput Measurement Units and the Kilo, Mega and Giga Multipliers

The standard unit for bit throughput is the “bit per second”, commonly abbreviated “bit/s”, “bps” or “b/s”. The byte unit is “byte per second”, abbreviated “bytes/s”, “Bps” or “B/s”— unless some cruel author decides to use a lower-case “b” just to confuse you. This means that the maximum theoretical throughput of 100BASE-TX (100 Mbps) Ethernet is about 12 MB/s. Where the context is unclear, it is better to spell out the unit as “100 Mbits/s” or “12 Mbytes/s”, which of course, I try to do in this Guide.

You will also occasionally, especially when dealing in the realm of communications, see throughput measured in characters per second, or “cps”. In most computer systems (including PCs) each character takes up one byte, so “cps” is equivalent to “bytes/s”, “B/s” or “Bps”.

Of course, most networking technologies don’t move just a few bits and bytes around every second; they move, thousands, millions, or even billions. Thus, most speed ratings are not in bits per second, but rather *kilobits* (kb), *megabits* (Mb), or *gigabits* (Gb) per second, and the same thing can be done for bytes. Thus, we find terms such as “100 Mbps Ethernet” or “700 kb/s ADSL”.

Here we run into another problem: the existence of both decimal and binary versions of the terms “kilo”, “mega” and “giga”. For example, the decimal form of the prefix for a million (“mega”) is 10^6 or 1,000,000, while the binary form is 2^{20} or 1,048,576. This differential of about 5% leads to all sorts of confusion. When you see these abbreviations, bear in mind that in networking, they almost always refer to the decimal form. Thus, 100 Mbps Ethernet is rated at 100,000,000 bits per second, not 104,857,600 bits per second.



Key Concept: The unit most often used to express networking throughput is *bits per second* or *bps*. This term is often expressed in thousands, millions or billions as *kbps*, *Mbps* or *Gbps*. It almost always uses the decimal, not binary, versions of the kilo, mega or giga multipliers.

Signaling Rate and the Baud

Finally, there’s another term that you will encounter frequently in discussions of modems and some other technologies: the *baud*. Named for telegraphy pioneer Jean Maurice Emile Baudot (1845-1903), this is a unit that measures the number of changes, or transitions, that occur in a signal in each second. So, if the signal changes from a “one” value to a “zero” value (or vice-versa) one hundred times per second, that is a rate of 100 baud.

In the early days of very slow modems, each bit transition encoded a single bit of data. Thus, 300 baud modems sent a theoretical maximum of 300 bits per second of data. This led to people confusing the terms “baud” and “bits per second”—and the terms are still used interchangeably *far* too often. You'll commonly hear people refer to a 28.8kbps modem, for example, as running at “28,800 baud”.

But the two units are in fact not the same; one measures data (the throughput of a channel) and the other transitions (called the *signaling rate*). Modern modems use advanced modulation techniques that encode more than one bit of data into each transition. A 28,800 bps modem typically encodes nine bits into each transition; it runs at 3,200 baud, not 28,800 baud (the latter number being the product of 3,200 and 9). In fact, there's no way to operate a modem on a conventional phone line at 28,800 baud—it exceeds the frequency bandwidth of the phone line. That's the reason why advanced modulation is used to encode more data into each transition.



Key Concept: The units *baud* and *bps* are often treated equivalently, but are not the same. *Baud* measures not the throughput of a network but its signaling rate, meaning the number of times that the signal changes value in each second. Since modern encoding and modulation techniques often encode either greater or fewer than one bit value into each such transition, the throughput and baud rate of network technologies are usually different.

Wow, when I started writing this topic, I never envisioned that I would have to write so much just to explain something that *should* be fairly simple. Leave it to computer people to complicate the simple, but well, there you have it. At least you should now be able to figure out what all those terms are about, and can impress your friends and relatives with explanations of why their 56k modem doesn't actually run at 56,000 baud. ☺

Theoretical and Real-World Throughput, and Factors Affecting Network Performance

When assessing the performance of networks, keep in mind that there is always a difference between theoretical speed ratings, and “real-world” throughput. If you are lucky—rather, if your network is set up well—then this difference is relatively small but still significant. Otherwise, the difference can be extremely large. Notice that there is no option for the difference between theoretical and practical performance being “negligible”!

Major Categories of Real-World Performance Impact Factors

The reasons for the difference between what a network or communications method is supposed to be able to do and what it can actually do are many. I consider them as generally falling into three categories: normal network overhead, external performance limiters, and network configuration problems.

Normal Network Overhead

Every network has some degree of normal network overhead, which guarantees that you will never be able to use all of the bandwidth of any connection for data. Take as an example 10 Mbit/s Ethernet. Sure, the line may be able to transmit 10,000,000 bits every second, but not all of those bits are data! Some are used to package and address the data—data can't just be thrown onto the network in raw form. Also, many of those bits are used for general overhead activities, dealing with collisions on transmissions, and so on. There are natural inefficiencies in any networking technology.

Even beyond this, there are other overhead issues. Any network transaction involves a number of different [hardware and software layers](#), and overhead exists at each of them, from the application and operating system down to the hardware. These overheads mean that you generally lose at least 20% of the “rated” speed of a LAN technology “off the top”, and sometimes even more. For example, 7 Mbits/s user data throughput on a regular 10 Mbit/s Ethernet network is actually very good.

External Performance Limiters

There are external factors that limit the performance of a network. Important issues here include the ability of the hardware to process the data, and also any bandwidth limitations that exist in the chain of data transmission between two nodes. Hardware issues most often show up with very fast networking technologies. Consider a Gigabit (1000 Mbps) Ethernet connection between two regular PCs. In “theory”, this connection should allow the transmission of 1 gigabit of data every second. Well, even beyond the matter of overhead mentioned above, no regular PC is capable of pumping this much data per second if its life depended on it. Only high-end servers have this capacity—and even they would have problems sustaining this unless they were doing nothing else. An older PC's hard disk probably can't even stream data fast enough to keep a 100 Mbit/s Ethernet connection busy. Thus, upgrading a 100 Mbps Ethernet card in an older machine to Gigabit is not likely to help as much as you might expect.

Bandwidth limitations cause network throughput issues because the entire network can only run as fast as its slowest link. These bottlenecks create reduced performance. As a common example, suppose you have a cable modem connection to the Internet that is rated at 1 Mbps for downloads. It may be very fast most of the time, but if the Web site you are accessing is totally bogged down, or it is having connectivity problems itself, you are not going to download from that site at 1Mbps. In fact, probably not even close.

Finally, it's also important to remember that there are many technologies that simply do not always operate at a constant fixed speed; they may change speeds based on physical network characteristics. A good example is an analog modem, which can vary greatly in performance depending on the quality of the line over which it operates.

Network Configuration Problems

The issues I mentioned above are usually ones that you cannot do anything about; they are just the nature of the networking beast. The third category of performance limiters, *misconfiguration*, is different. This refers to network slowdowns that occur because hardware or software have not been set up correctly. Poor cabling, misconfigured interface cards, or bad drivers can **seriously** reduce the performance of a network—by 90% or even more.

These problems can usually be corrected, but only if you are looking for them. Driver problems are particularly insidious because the natural tendency is for people to blame hardware when slowdowns occur. However, you cannot get the most of your hardware devices without proper software to run it. These issues are much more significant with “bleeding edge” hardware than with established products, incidentally.

Also included in this category of issues are problems that occur due to poor design. For example, putting 30 busy workstations on a shared 10 Mbit/s Ethernet segment is likely to result in poor performance—using a network switch would be much better, since this would create multiple, independent segments for higher performance. Another common mistake is not providing a “fatter pipe” (higher bandwidth connection) to servers in a client/server setup. These issues can be avoided or ameliorated by reconfiguring the network—or even better, designing it properly in the first place, right?

The Effect of Asymmetry

In addition to the above, bear in mind that many networking technologies, especially ones used for Internet access, are *asymmetric*, meaning that they offer much higher bandwidth in one direction than the other. Usually, this is arranged so that more bandwidth goes down to the user than from the user to the network, since most Internet users download far more than they upload. However, it's always important to find out if a speed rating is for both directions, or for only one direction, and if so, what the other direction's speed is. Common technologies with asymmetric performance include 56k modems, ADSL, cable modems, and satellite Internet access. Beware, because the marketing droids who sell these technologies will often try to hide the asymmetry of their services, usually highlighting only the bigger download figure and avoiding mention of the slower uploads.

Asymmetry can also have unexpected effects on network performance, because most communications, even if they seem unidirectional, are not. The most common case is when an Internet access technology has much higher download bandwidth than upload bandwidth. When using TCP/IP to download data, acknowledgments must be sent regularly. If the upstream bandwidth is too low, this may make it impossible to fully exploit the download bandwidth of the link.

Performance Metric Issues

Finally, take into account that there are many different ways of measuring and assessing performance. Synthetic benchmark programs are often used to measure throughput, and can produce impressive performance scores—which usually have little to do with how a network will actually operate. Such metrics are best used for comparison purposes, by

showing that one network or system is faster than another, rather than paying too much attention to the actual number they produce. Even when doing comparisons, however, caution is wise.



Key Concept: The theoretical rated speed of a network is never achieved in practice, for a number of reasons. *Overhead* issues mean that not all of the possible capacity of a network can be used for data. *External factors* such as hardware bandwidth limitations restrict data input and output. *Configuration problems* can also greatly reduce real-world performance. Finally, it is important to remember that many technologies are asymmetric, offering higher speed in one direction than the other, and the larger number is often the one that is advertised.

Simplex, Full-Duplex and Half-Duplex Operation

Another aspect of performance that is worthy of some attention is the mode of operation of the network or connection. Obviously, whenever we connect together device *A* and device *B*, there must be some way for *A* to send to *B* and *B* to send to *A*. Many people don't realize, however, that networking technologies can differ in terms of how these two directions of communication are handled. Depending on how the network is set up, and the characteristics of the technologies used, performance may be improved through the selection of performance-enhancing modes.

Basic Communication Modes of Operation

Let's begin with a look at the three basic modes of operation that can exist for any network connection, communications channel, or interface.

Simplex Operation

In simplex operation, a network cable or communications channel can only send information in one direction; it's a "one-way street". This may seem counter-intuitive: what's the point of communications that only travel in one direction? In fact, there are at least two different places where simplex operation is encountered in modern networking.

The first is when two distinct channels are used for communication: one transmits from *A* to *B* and the other from *B* to *A*. This is surprisingly common, even though not always obvious. For example, most if not all fiber optic communication is simplex, using one strand to send data in each direction. But this may not be obvious if the pair of fiber strands are combined into one cable.

Simplex operation is also used in special types of technologies, especially ones that are asymmetric. For example, one type of satellite Internet access sends data over the satellite only for downloads, while a regular dial-up modem is used for upload to the service provider. In this case, both the satellite link and the dial-up connection are operating in a simplex mode.

Half-Duplex Operation

Technologies that employ half-duplex operation are capable of sending information in both directions between two nodes, but only one direction or the other can be utilized at a time. This is a fairly common mode of operation when there is only a single network medium (cable, radio frequency and so forth) between devices.

While this term is often used to describe the behavior of a pair of devices, it can more generally refer to any number of connected devices that take turns transmitting. For example, in conventional Ethernet networks, any device can transmit, but only one may do so at a time. For this reason, regular (unswitched) Ethernet networks are often said to be “half-duplex”, even though it may seem strange to describe a LAN that way.

Full-Duplex Operation

In full-duplex operation, a connection between two devices is capable of sending data in both directions simultaneously. Full-duplex channels can be constructed either as a pair of simplex links (as described above) or using one channel designed to permit bidirectional simultaneous transmissions. A full-duplex link can only connect two devices, so many such links are required if multiple devices are to be connected together.

Note that the term “full-duplex” is somewhat redundant; “duplex” would suffice, but everyone still says “full-duplex” (likely, to differentiate this mode from half-duplex).

Comparing Half-Duplex and Full-Duplex Operation

Of these three options, full-duplex is obviously the one that yields the highest performance. Full-duplex operation doubles the theoretical bandwidth of the connection. If a link normally runs at 1 Mbps but can work in full-duplex mode, it really has 2 Mbps of bandwidth (1 Mbps in each direction). Remember the key word “theoretical” however—you do not really get double the performance in real life, because communications usually do not involve sending lots of data in both directions at once. However, you certainly get better throughput than in a half-duplex mode.

In some cases, the mode of operation is a function of the technology and cannot be changed. In others, however, full-duplex mode is a matter of the correct hardware settings, and also whether the software supports full-duplex operation or not. Thus, getting higher performance in this area is sometimes simply a matter of ensuring proper configuration.

Full-duplex operation has been pretty much taken for granted in communications for years. The more interesting development has been the rise in significance of full-duplex operation for local area networking. Traditionally, LANs have always used half-duplex operation on a

shared access medium. As the use of switches has increased, allowing dedicated bandwidth to each computer, full-duplex operation has become very popular. Full-duplex operation in Ethernet not only allows the simultaneous transmission of data in both directions, it also eliminates contention for the formerly shared access medium—no more collisions. The combination of these two effects improves performance, sometimes substantially.



Key Concept: There are three basic operating modes that describe how data is sent between connected devices on a network. In *simplex* operation, data can flow in only one direction between two devices. *Half-duplex* networks allow any device to transmit, but only one may do so at a time. *Full-duplex* operation means two attached devices can each transmit and receive simultaneously—this offers the greatest potential performance, since throughput is not decreased by forcing one device to wait for another before sending data.

Quality of Service (QoS)

I mentioned in my [discussion of common network performance measurements](#) that there were many different aspects to network performance. I also introduced the concept of *latency*, which measures how long it takes for data to travel across a network. Latency is one important part of a larger issue in networking that is sometimes called *quality of service* or QoS.

The inherent nature of most networking technologies is that they are more concerned with pumping data from one place to another as fast as possible than they are with how the data is sent. For example, the Internet is designed on top of the [Internet Protocol](#), a [packet-switching technology](#) that is designed to get packets from point “A” to point “B” in whatever way is most effective, without the user necessarily having any ability to know what route will be taken. In fact, some packets in the same data stream may be sent along different routes. Packets may be stored for a while before being forwarded to their destination, or even dropped and retransmitted.

For most applications, such as simple file or message transfers, this is perfectly fine. However, there are applications where this sort of service is simply of “too low quality”. In these cases, the nature of how the data is delivered is more important than merely how fast it is, and there is a need for technologies or protocols that offer “quality of service”. This general term can encompass a number of related features; common ones include the following:

- ☉ **Bandwidth Reservation:** The ability to reserve a portion of bandwidth in a network or interface for a period of time, so that two devices can count on having that bandwidth for a particular operation. This is used for multimedia applications where data must be streamed in real-time and packet rerouting and retransmission would result in problems. This is also called *resource reservation*.

-
- ☉ **Latency Management:** A feature that limits the latency in any data transfer between two devices to a known value.
 - ☉ **Traffic Prioritization:** In conventional networks, “all packets are created equal”. A useful QoS feature is the ability to handle packets so that more important connections receive priority over less important one.
 - ☉ **Traffic Shaping:** This refers to the use of buffers and limits that restrict traffic across a connection to be within a pre-determined maximum.
 - ☉ **Network Congestion Avoidance:** This QoS feature refers to monitoring particular connections in a network, and rerouting data when a particular part of the network is becoming congested.

So, in essence, quality of service in the networking context is analogous to quality of service in the “real world”. It is the difference between getting take-out and sit-down service at a nice French restaurant—both cure the hunger pangs, but they meet very different needs. Some applications, especially multimedia one such as voice, music and video, are time-dependent and require a constant flow of information more than raw bandwidth; for these uses, a burger and fries in a paper bag just won’t cut the mustard. 😊



Key Concept: The generic term *quality of service* describe the characteristics of how data is transmitted between devices, rather than just how quickly it is sent. Quality of service features seek to provide more predictable streams of data rather than simply faster ones. Examples of such features include bandwidth reservation, latency minimums, traffic prioritization and shaping, and congestion limitation. Quality of service is more important for specialty applications such as multimedia than for routine applications such as those that transfer files or messages.

To support quality of service requirements, many newer technologies have been developed or enhanced to add quality of service features to them. This includes the ability to support *isochronous transmissions*, where devices can reserve a specific amount of bandwidth over time to support applications that must send data in real time. One technology that has received a lot of attention for its quality of service features is Asynchronous Transfer Mode (ATM). ATM is designed to support traffic management features that are not generally available on networks not created to provide quality of service features (such as Ethernet)



Note: “Quality of service” has become a big buzzword, lately. By itself, this term conveys about as much useful information about what the technology offers as being told that it is “high performance”. You have to dig past the marketingspeak and find out exactly what QoS features are being offered.



Network Standards and Standards Organizations

You can't study networking and its related technologies without very quickly encountering a whole host of standards that are related to the subject—and organizations that create these standards. Network standards facilitate the interoperability of network technologies and are extremely important. It may be an exaggeration to say that networking wouldn't exist without standards, but it isn't to say that networking *as we know it* would not exist without them. Networks are literally everywhere, and every hardware device or protocol is governed by at least one standard, and usually many.

In this section I provide a brief examination of the often-overlooked subject of network standards and standards organizations. I begin with a background discussion of why standards are important, highlighting the differences between proprietary, de facto and open standards. I give an overview of networking standards in general terms, and then describe the most important international standards organizations and industry groups related to networking. I then describe the structure of the organizations responsible for Internet standards, including the registration authorities and registries that manage resources such as addresses, domain names and protocol values. I conclude with a discussion of the Request For Comment (RFC) process used for creating Internet standards.

Proprietary, Open and De Facto Standards

Why are standards important? Well, because I said so. They are. Alright, fine, I'll try to do a bit better than that; even my young kids won't take that for an answer any more. But I have to warn you that the proper answer is a lot longer than the cute answer. ☺

An old saw in the computer world says that “the beauty of standards is that there are so many to choose from”. This little joke reflects the frustration that technicians often feel at the sheer number of standards that are found in the industry: thousands. Aside from differing in terms of content—what technologies and protocols they describe—standards also often differ in terms of the type of standards they are, and how they came about. In fact, part of the reason why there are sometimes “so many to choose from” in a particular area is *because* of how they come about.

Proprietary Standards

In the early days of computing, many people didn't quite understand just how important universal standards were. Most companies were run by skilled inventors, who came up with great ideas for new technologies and weren't particularly interested in sharing them. It wasn't considered a “smart business move” to share information about new inventions with other companies—the competition! Oh sure, every company believed that standards were important, but they thought it was even more important that *they* be the ones to control those standards.

I'll give you an example of what I mean. Let's imagine that it's 1985, and I have just come up with a great networking technology, which I have incorporated into a fancy new local area networking product called "SooperDoooperNet". (Catchy, eh?) SooperDoooperNet is *my* product. I have patents on the technology, I control its design and manufacture, and I sure as heck don't tell anyone else how it works—if I did, they would copy me, right?

Now, I could sell interface cards, cables and accessories for SooperDoooperNet, and a company that wanted to use it could install the cards in all of their PCs and be assured that they would be able to talk to each other. This solves the interoperability problem for this company by creating a "SooperDoooperNet standard". This would be an example of a *proprietary* standard—it's owned by one company or person.

The problem with proprietary standards is that other companies are excluded from the standard development process, and therefore have little incentive to cooperate with the standard owner. In fact, just the opposite: they have a strong motivation to develop a competing proprietary standard, even if it doesn't improve on the existing one.

So when my competition sees what I am doing, he is not going to also create network interface cards that can work with SooperDoooperNet, which would require paying me a royalty. Instead, he's going to develop a new line of networking hardware called MegaAwesomeNet, which is very similar to SooperDoooperNet in operation but uses different connectors and cable and logic. He too will try to sell bunches of cards and cables—to my customers, if possible!

You can see what the problem is here: the market ends up with different companies using different products that can't interoperate. If you install SooperDoooperNet, you *have* to come to me for any upgrades or changes—you have no choices. Worse, what happens if Acme Manufacturing, which has 50 PCs running SooperDoooperNet, merges with Emca Manufacturing, which has 40 PCs running MegaAwesomeNet? Well, the IT people have a problem, that's what. Sure, there would be ways to solve it, but wouldn't everyone be better off to just avoid these difficulties in the first place? And how could you create something like the Internet if everyone's networks used different "standards"?

Open Standards

Eventually, companies learned that they would be better off to have standards that everyone agreed with, instead of constantly fighting with each other. This is particularly true of networking, where devices need to talk to each other. If many companies get together and agree to cooperate, they can create an *open standard* instead of a bunch of proprietary ones. The name is rather self-explanatory; rather than being the closely-guarded secret of one organization, an open standard is available to any who are interested in using it.

One key to the success of an open standard is a steering organization to promote it. Usually, a neutral, non-profit trade association or working group is established to develop and promote the standard, and the various for-profit hardware and software companies join this group and support it financially. These groups also work with [standards approval bodies](#) like the ITU and ISO to gain acceptance for their standards.

Of course, the companies aren't doing this just to be nice to their customers. In creating open standards, they split the “market share pie” between them, but they make the pie grow much larger by attracting more customers. Customers like open standards more than proprietary ones, because they give them more choices, and increase their ability to interact with other companies, troubleshoot problems, hire skilled workers, and expand in the future. As for the companies, they still compete in their specific offerings, so it's not like they all end up making the same products. For all of these reasons, open standards are now far more common than proprietary ones.

However, the process involved in creating these standards is often a difficult one. In some cases the standards organization will draft the standard from the ground up, but in others it may select one technology as the basis for the standard from several that are submitted in what is commonly called a “technology bake-off”. Thus, many different companies may come to the table with different approaches, each of them vying for selection as the standard for use by the group. Politics can cause groups to get bogged down for years fighting over various options, or even to split into multiple groups. Good examples are what occurred in the conflict between supporters of 100VG-AnyLAN and Fast Ethernet, and the problems with standards politics that have plagued the world of powerline networking.

Furthermore, there are still some companies that believe strongly in proprietary standards, because they really want to control and direct the market. One of the most famous/infamous in this regard is Sony, a company that makes excellent hardware but frequently refuses to accept established standards. For this reason, some people avoid their products, even though they are good; because they want to stick to industry standards.

De Facto Standards

This brings me to the third type of standard that is often seen in the computer world: the *de facto* standard. “De facto” is Latin for “in fact”, so a de facto standard is one that is used as a universal standard just because over time it became widely used, and not because the standard was developed and approved by a standards committee. A good example of a de facto standard is the “AT” command set used by modems; virtually all modems use it, but this resulted not from an industry group agreeing to adopt and deploy it. Rather, it was developed unilaterally by Hayes, the pioneering modem company, and then adopted by virtually every other modem maker until it became a standard.

One reason why proprietary standards are still sometimes seen is that some companies want to produce a standard that will become so universally used that it becomes the de facto standard, thus giving them a leadership position in that market. Again, in my estimation Sony falls into this category—they often want to do things “their way” and create proprietary standards that they try to promote using their powerful market presence.

Sometimes this succeeds but often it does not, resulting a fragmented market of incompatible products. An excellent example is when Sony created a new format for digital camera flash memory (the “memory stick”) rather than using the CompactFlash format used by other camera manufacturers. The result of this was not everyone using memory sticks as Sony had hoped, but two incompatible standards that increase confusion and yield no real benefit to the customer.



Key Concept: Networking standards can be classified as *proprietary*, *open* or *de facto*. *Proprietary* standards are owned by one particular organization. If that organization has sufficient market clout and the industry lacks alternatives to its standard, it may be adopted by the whole industry, becoming a *de facto* standard. Usually, however, differing proprietary standards compete with each other, resulting in a fragmented market. In contrast, *open* standards are not owned by anyone—they are created by neutral organizations to ensure that compatible products can be designed and developed by many different companies. This makes life easier for the customer as well as promoting the market as a whole.

Networking Standards

All networking technologies have standards associated with them. These are usually highly technical documents, and often presume that the reader has a fair bit of knowledge about networking. If you aren't an expert, you will probably have some difficulty understanding networking standards. (Some people seem to think *I* am an expert, but I too have trouble with most of the details in a typical networking standard.)

In fact, many technologies have quite a number of standards associated with them. A networking technology may have more than one standard for any or all of the following reasons:

- The original standard has been revised or updated;
- The technology is sufficiently complex that it needs to be described in more than one document;
- The technology borrows from or builds on documents used in related technologies;
- More than one organization has been involved in developing the technology.

Standards documents created in the United States are usually developed in English, but are also routinely translated into other languages. European standards are often published simultaneously in English, French and German, and perhaps other languages as well.

Today, virtually all networking standards are “open” standards, administered by a standards organization or industry group. As I explained in the [previous topic](#), open standards are more popular than proprietary ones in the computer industry, and that's particularly so when it comes to networking. In fact, the few technologies where there is no universally-accepted open standard have been losing ground to those with open standards, particularly in the areas of wireless LANs and home networking—pretty much proving how important an open process really is.

I considered having a separate section where I listed all of the various standards used for networking within the Guide. However, this would be a very large section indeed, and the discussions of the various standards would be somewhat “detached” from the places where I describe the technologies they define. Instead, I have many different smaller discussions

of standards, within the sections where I describe each networking method or protocol. These can usually be found in an overview topic introducing each technology type, though for more complex protocols I have a dedicated topic just discussing relevant standards and where they are documented.

International Networking Standards Organizations

The rise of [open standards](#) not owned by any one company has been a great boon to customers of computer and networking products, as well as the manufacturers that sell to them. In order to facilitate the development of open standards, however, organizations are needed that will coordinate the creation and publishing of these documents. Generally, these are non-profit organizations that specifically take a neutral stance regarding technologies and work for the betterment of the industry as a whole.

Here are some of the standards organizations that you are likely to encounter when reading about networking and the Internet:

- **International Organization for Standardization (ISO):** Probably the biggest standards organization in the world, the ISO is really a federation of standards organizations from dozens of nations. In the networking world, the ISO is best known for its [OSI Reference Model](#).



Note: The shortened name of the International Organization for Standardization is indeed “ISO”, and not “IOS” as you might imagine. In fact, it is not an acronym at all. Since the full name of the body differs from one language to the next, any acronym for that name would differ as well. Instead, the organization chose the name “ISO” from the Greek word “isos”, meaning “equal”. Many people, especially in the United States, think “ISO” is short for “International Standards Organization”, but this is incorrect.

-
- **American National Standards Institute (ANSI):** ANSI is the main organization responsible for coordinating and publishing computer and information technology standards in the United States. While they are commonly thought of as developing and maintaining standards, they do neither. Instead, they oversee and accredit the organizations that actually create the standards, qualifying them as *Standards Developing Organizations* or *SDOs*. ANSI also publishes the standards documents created by the SDOs, and serves as the United States' representative to the ISO.
 - **Information Technology Industry Council (ITIC):** ITIC is a group of several dozen companies in the information technology (computer) industry. ITIC is the SDO approved by ANSI to develop and process standards related to many computer-related topics. It was formerly known as the *Computer and Business Equipment Manufacturers Association (CBEMA)*.

-
- ④ **National Committee for Information Technology (NCITS):** A committee established by the ITIC to develop and maintain standards related to the information technology world. NCITS was formerly known by the name *Accredited Standards Committee X3, Information Technology*, or more commonly, just X3. It maintains several sub-committees that develop and maintain standards for various technical subjects.
 - ④ **Institute of Electrical and Electronics Engineers (IEEE):** The IEEE (pronounced “eye-triple-ee”) is a well-known professional organization for those in the electrical or electronics fields, including computers and networking. IEEE’s main claim to fame in the networking industry is the IEEE 802 Project, which encompasses many popular networking technologies including Ethernet.
 - ④ **Electronic Industries Alliance (EIA):** The EIA is an international industry association that is best known for publishing electrical wiring and transmission standards.
 - ④ **Telecommunications Industry Association (TIA):** The TIA is the communications sector of the EIA, and is responsible for developing communications standards. Since communications, wiring and transmission are all related, and since the TIA and EIA organizations are also related, standards produced by the EIA or TIA are often labeled with the combined prefixes “EIA/TIA” or “TIA/EIA”.
 - ④ **International Telecommunication Union - Telecommunication Standardization Sector (ITU-T):** ITU-T is another large international body that develops standards for the telecommunications industry. The ITU-T was formerly named the *International Telephone and Telegraph Consultative Committee* or *CCITT* (the abbreviation was of the French version of the organization’s name, *Comité consultatif international téléphonique et télégraphique*.)
 - ④ **European Telecommunications Standards Institute (ETSI):** An organization with members from dozens of countries both within and outside Europe that is dedicated to developing telecommunications standards for the European market (and elsewhere). ETSI is known for, among other things, regulating the use of radio bandwidth in Europe and developing standards such as HiperLAN.

This list represents some of the more important organizations that are responsible for establishing and publishing standards in the networking world. It is not an exhaustive list, however. I should also point out that the set of related organizations responsible for creating Internet standards is not shown in this list as I have covered them in two dedicated topics on [Internet standards organizations](#) and [registration authorities](#).

I want to emphasize that many of the organizations above do not actually develop the various standards. Generally, these are oversight organizations—“high level management” if you will—that work with many other smaller groups who actually develop the standards. Also, in many cases a particular standard may be published by more than one standards organization, so it may be labeled with more than one name.



Key Concept: There are a number of well-known international organizations that play an important role in the development of open networking standards. Some of the most important of these are ISO, ANSI, ITIC, IEEE, EIA/TIA, ITU-T and ETSI. These are oversight organizations, responsible for overall management of the standards development process, rather than for the particulars of creating individual standards.

Networking Industry Groups

As I explained in the [previous topic](#), most open standards are coordinated and published by a small number of large, often international standards organizations. However, these are not the only groups of people who are involved in the development of standards for networking and Internet technologies. There are also many different networking *industry groups* that play an important role in the standard creation process.

Networking industry groups differ in a few ways from standards organizations. They are typically dedicated to the promotion of a specific technology, where standards organizations are more generic and handle the oversight of hundreds of different ones. Industry groups are also generally smaller than standards organizations, with members drawn primarily from the field of developers and manufacturers that create products for the particular technology the group promotes.

Perhaps most importantly, industry groups often actually write and maintain the standards, where standards organizations are generally more “supervisors” who ensure that the standards meet, well, the standards for the development of standards. Some industry groups, however, are concerned only with marketing and promotion activities.

Obviously, these industry groups work closely together with the standards organizations. In some cases, they may even be part of the same overall organization, and all of the different groups are related in some ways. For example, the IEEE 802 project consists of a number of working groups that are charged with maintaining and developing specific technology standards, which the larger IEEE organization approves and publishes.

One of these working groups is the 802.11 working group, which develops wireless Ethernet technology. At the same time that this group “does its thing”, there is an industry group called the *Wireless Ethernet Compatibility Alliance (WECA)*. This group works to ensure the cross-vendor compatibility of 802.11b wireless networking hardware and software.

Other industry groups are formed specifically to develop independent standards that are not approved through a formal standardization process. Examples include groups such as HomePNA, IrDA and HomeRF. One of the problems with these groups is that they usually do not make their standards open to the public. This is undoubtedly due to some sort of security concern or desire to keep the “inner workings” of their technology “secret”.

Unfortunately for these groups, this policy harms the ability of regular people to learn about how their technologies work. For example, in writing this and other reference works, I am almost always unable to obtain specifications from most of the private industry groups. They either refuse to allow me to get the document at all, or want to charge me a great deal of money for the privilege (well into the thousands of dollars in some cases). In doing this, these groups harm their own cause, by making it more difficult for those interested in their technologies to learn about them. This is another key advantage of open standards managed by public organizations such as ANSI or the IEEE.

Internet Standards Organizations (ISOC, IAB, IESG, IETF, IRSG, IRTF)

High-quality, widely-accepted [open standards](#) become more important the larger the number of people that use a network. The largest network of all is of course the *Internet*, which connects millions of people on thousands of individual networks into a globe-spanning internetwork. The Internet has revolutionized not only networking and computing, but communication, business, and even society as a whole. One of the critical factors in the success of the Internet has been its development using open standards.

Of course, nobody sat down one day and said “hey, let’s create the Internet!” (No, not even Al Gore. ☺) It began as a small research network, and was developed over time concurrently with the technology set that implemented it: [TCP/IP](#). At first, a relatively small organization was sufficient to manage the development of Internet standards and oversee its activities, but as the Internet continued to grow, this became inadequate. Eventually a more formalized structure of organizations was required, to manage the Internet development process and other activities to ensure the continued success and growth of the Internet and the TCP/IP technologies that power it.

Today, there are six organizations that are responsible for the development of the Internet’s architecture, standards and policies, and related activities. They are closely-related, with certain organizations being responsible for oversight of others, as shown in [Figure 7](#). These organizations perform many tasks, and can be somewhat confusing to understand, since many have similar-sounding names and responsibilities. Therefore, I will concentrate mostly on their role in the development of Internet standards, since that is our primary interest in this discussion.

Key Internet Standards Organizations

Here is a brief description, rather simplified, of the key Internet standards organizations:

- ☉ **Internet Society (ISOC):** A professional society responsible for general, high-level activities related to the management, development and promotion of the Internet. ISOC has thousands of individual and organizational members that engage in activities such as research, education, public policy development and standardization. It is responsible for providing financial and administrative support to the other organizations listed below. From the standpoint of standards development, ISOC’s key role is its responsibility for oversight of the IAB.

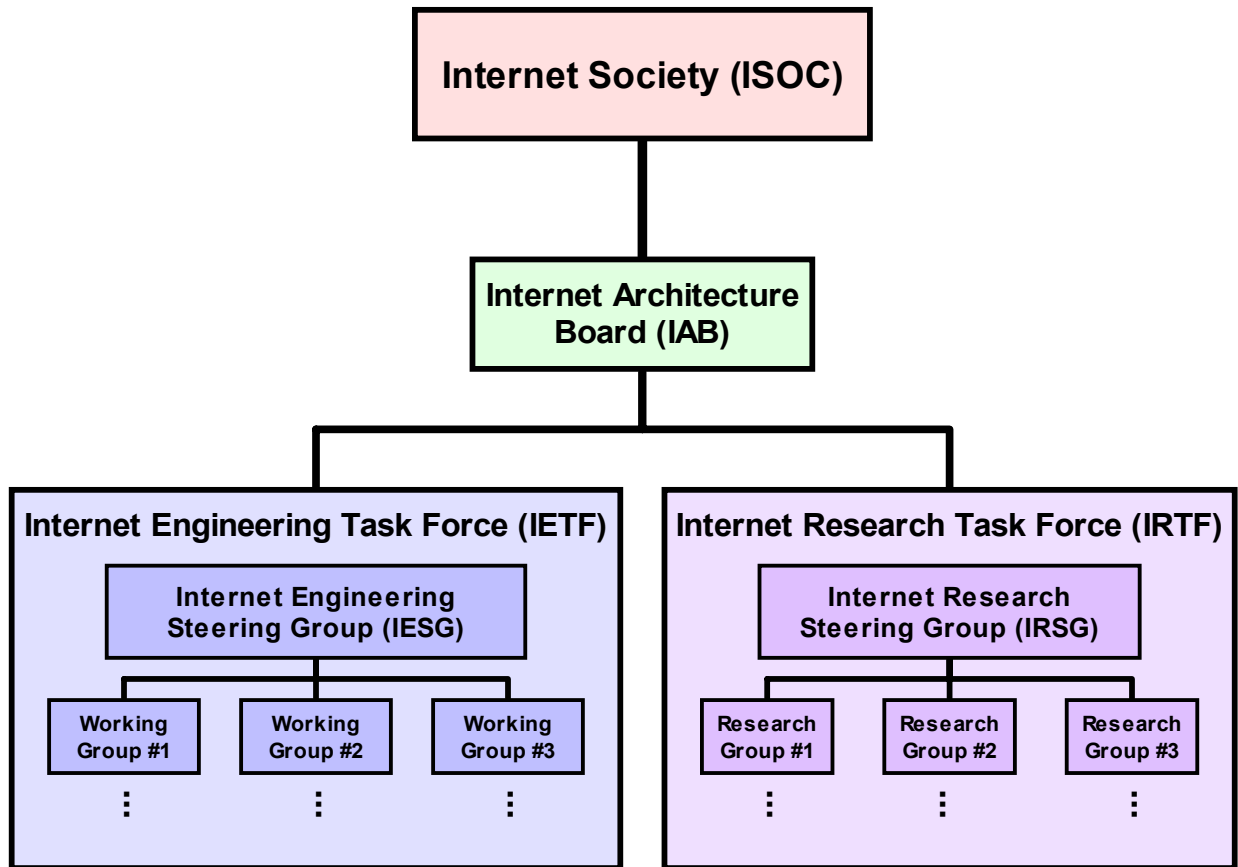

Figure 7: Internet Standards Organizations

The *Internet Society (ISOC)* oversees the *IAB*, which in turn directs the *IETF* and *IRTF*. The *IETF* develops current Internet and TCP/IP standards, and is headed by the *IESG*, which manages *IETF working groups (WGs)*. The *IRTF* is the *IETF*'s research counterpart, containing *research groups (RGs)* led by the *IRSG*.

- ☉ **Internet Architecture Board (IAB):** Formerly the *Internet Activities Board*, the IAB is charged with overall management of the development of Internet standards. It makes “big picture” policy decisions related to how Internet technologies and structures should work, to ensure that various standardization efforts are coordinated and consistent with overall development of the Internet. It is responsible for publishing [Internet standards \(RFCs\)](#). It advises the ISOC, and oversees the IETF and IRTF; it also acts as an appeals body for complaints about the standardization activities performed by the IETF. The charter of the IAB is described in RFC 2850.
- ☉ **Internet Engineering Task Force (IETF):** The IETF focuses on issues related to the development of current Internet and TCP/IP technologies. It is divided into a number of *working groups (WGs)*, each of which is responsible for developing standards and technologies in a particular area, such routing or security. Each area is managed by an *area director (AD)*, who serves on the IESG. The IETF is overseen directly by the IESG and in turn by the IAB; it is described in RFC 3160.

-
- ☉ **Internet Engineering Steering Group (IESG):** The IESG is directly responsible for managing the IETF and the Internet standards development process. It consists of each of the area directors of the IETF, who make final decisions about the approval of proposed standards, and works to resolve any issues that may arise in the standardization process. The IESG is technically considered part of the IETF and is also described in RFC 3160.
 - ☉ **Internet Research Task Force (IRTF):** Where the IETF is focused primarily on short-term development issues, the IRTF is responsible for longer-term research related to the Internet and TCP/IP technologies. It is a much smaller organization than the IETF, consisting of a set of *research groups (RGs)*, which are analogous to the IETF's working groups. The IRTF is overseen by the IRSG and IAB. It is described in RFC 2014.
 - ☉ **Internet Research Steering Group (IRSG):** The IRSG manages the IRTF in a similar way to how the IESG manages the IETF. It consists of the chairs of each of the IRTF research groups and works with the chair of the whole IRTF to make appropriate decisions on research activities. It is also discussed in RFC 2014.

The Importance of the IETF

Of these organizations, the IETF is the one that you will most often hear referenced, because that is the organization directly responsible for the development of the majority of Internet standards. It is for this reason that throughout this Guide, whenever I mention Internet standards development efforts, I refer to the IETF as doing the work. This is of course a bit of an oversimplification, since all of these organizations play a role in the standards development process, [described in more detail in a separate topic](#).

Other Responsibilities of Standards Organizations

I also feel I should re-emphasize that many of these organizations are responsible for a great deal more than just standards development. This is especially true of the Internet Society, for which standardization is just one of many activities. The IAB also performs a number of functions not strictly associated with standards development, including managing [the assignment of protocol values done by IANA](#) and acting as a liaison between the Internet standards organizations and other standards bodies.



Key Concept: A group of related organizations is responsible for the development of TCP/IP standards and Internet technologies. The *Internet Society (ISOC)* has overall responsibility for many Internet activities including standards development. It oversees the *Internet Architecture Board (IAB)*, which makes high-level decisions about Internet technology development. Most of the actual work of creating current Internet standards is performed by the *Internet Engineering Task Force (IETF)*, which is managed by the *Internet Engineering Steering Group (IESG)*. Longer-term research is done by the IETF's sibling organization, the *Internet Research Task Force (IRTF)*, led by the *Internet Research Steering Group (IRSG)*.

Internet Registration Authorities and Registries (IANA, ICANN, APNIC, ARIN, LACNIC, RIPE NCC)

The success of the global Internet relies on the development of universally-accepted standards for protocols and other technologies. [Internet standards organizations](#) such as the IETF are thus critically important; they manage the standards development process, to ensure that everyone agrees on how to create hardware and software that will work together to communicate world-wide.

Important Standardization Functions

While the need to standardize protocols seems obvious, there are a couple of other aspects to Internet standardization that are equally important but perhaps not quite as well understood:

- ☉ **Parameter Standardization:** Most protocols rely on the use of parameters that control how they function. As just two of many, many examples, the [Internet Protocol](#) has a set of numbers that define different IP options, and the [Address Resolution Protocol \(ARP\)](#) has an *Operation Code* field that can take on many different values. Just as it is essential for devices to agree on what protocols to use, they must also agree on what parameters to use for those protocols, if communication is to be successful.
- ☉ **Global Resource Allocation and Identifier Uniqueness:** There are a number of resources that are used on the Internet that must be allocated from a fixed set of values and where uniqueness in assignment is essential. The most obvious example is that each TCP/IP host must have a unique [IP address](#); another important example is ensuring that only one organization uses a given [DNS domain name](#). If two devices have the same IP address or two organizations try to use the same domain name, the results would be unpredictable, but almost certainly bad.

Internet Centralized Registration Authorities

In both of the cases above, some sort of centralized organization is required. We need a group to take responsibility for managing parameters and ensuring that everyone uses the same ones, just as they use the same protocols. We also need to coordinate the assignment of identifiers such as addresses and names, to ensure that they are created and allocated in a way that is acceptable to all. In the world of the Internet, these are sometimes called *management authorities* or *registration authorities*.

The organization originally responsible for this task was the *Internet Assigned Numbers Authority (IANA)*. Amazingly, while the name makes it sound like the IANA was a huge bureaucracy, it was effectively one man: Jonathan B. (Jon) Postel, one of the most important pioneers of Internet and TCP/IP technologies. Jon Postel ran IANA until his untimely and unfortunate death in 1998.

IANA was originally charged with the task of managing which IP address blocks had been assigned to different companies and groups, and maintaining periodically-published lists of Internet parameters such as [UDP and TCP port numbers](#). It also was in charge of registrations of DNS domain names, which were more directly handled by the *Internet Network*

Information Center (InterNIC), a service managed by the United States government. *Network Solutions Inc. (NSI)* was later granted the contract to manage the InterNIC, and was eventually purchased by Verisign.

As the Internet continued to grow, an effort commenced in the mid-1990s to define a new organization that would be responsible for the central registration of Internet addresses and names. This took the form of a new private, non-profit company called the *Internet Corporation for Assigned Names and Numbers (ICANN)*. ICANN is officially charged with all of the centralized registration tasks I have mentioned so far in this topic, including IP address assignment, DNS domain name assignment, and protocol parameters management.

In a simpler world, this development would have meant that ICANN would have replaced IANA, which would no longer exist. Instead, ICANN kept IANA around, leaving that organization in charge of overseeing IP address registration and Internet parameters. ICANN is of course now in charge of IANA, so really both organizations are responsible for IP addresses and parameters. This often leads to confusion, and to make things worse, it is common to see IANA and ICANN mentioned in conjunction as “IANA/ICANN” or “ICANN/IANA”.



Key Concept: Internet registration authorities are centralized organizations responsible for coordinating protocol parameters and globally-assigned resources such as IP addresses. The first such organization was the *Internet Assigned Numbers Authority (IANA)*, which was initially in charge of IP address assignment, DNS domain name management and protocol parameters. Today the *Internet Corporation for Assigned Names and Numbers (ICANN)* has overall responsibility for these activities; the IANA operates under the auspices of ICANN and is still responsible for IP address assignment and parameter coordination.

Modern Hierarchy of Registration Authorities

In the original “classful” IP addressing scheme, addresses were assigned to organizations directly by IANA in address blocks: Class A, Class B and Class C addresses. Today, a hierarchical, classless addressing system called [Classless Inter-Domain Routing \(CIDR\)](#) is used instead. Address assignment in CIDR involves the hierarchical allocation of blocks of addresses, starting with large blocks that are given to big organizations, which split them to assign to smaller groups. (Much more detail on these methods can be found in the [large section on IP addressing](#).)

IANA, as the organization in charge of all IP addresses, assigns the largest blocks of addresses to *regional Internet registries (RIRs)* that are responsible for further allocation activities. Each RIR manages IP addresses and other Internet number resources (such as [autonomous system](#) numbers) for a particular region. The four regional registries are:

- ☉ **Asia Pacific Network Information Centre (APNIC):** Covers the Asia/Pacific region.
- ☉ **American Registry for Internet Numbers (ARIN):** Manages North America, part of the Caribbean, and sub-equatorial Africa.

-
- ④ **Latin American and Caribbean Internet Addresses Registry (LACNIC):** Responsible for Latin America and part of the Caribbean.
 - ④ **Réseaux IP Européens Network Coordination Center (RIPE NCC):** Takes care of Europe, the Middle East, Central Asia, and Africa north of the equator.

Each registry may assign address blocks to Internet service providers (ISPs) directly, or further delegate them to *national Internet registries (NIRs)* or smaller *local Internet registries (LIRs)*. [See the topic on IP address allocation issues for more details.](#)

Name registration has changed over the last several years. It is no longer part of IANA's responsibilities, and ICANN has opened up the name registration business so it is no longer the province of a single organization such as InterNIC/Network Solutions/Verisign. Now, many different accredited registrars can be used for name registration in many of the popular top-level domains. [This is discussed in the topic on DNS public registration.](#)



On The Web: The complete list of documents containing Internet and TCP/IP protocol parameters can be found on the IANA's web site at: <http://www.iana.org/numbers.html>

Internet Standards and the Request For Comment (RFC) Process

The precursors of the modern Internet were diminutive networks developed and run by a small group of computer scientists and engineers. These technologists knew that developing [open, widely-adopted standards](#) would be essential to the eventual growth of the Internet and the [TCP/IP protocol suite](#). But there was no formalized standards development mechanism back then.

Consensus-Based Standardization Using Requests For Comments (RFCs)

Standardization was achieved largely through building consensus through discussion about new technologies and protocols. If someone had a proposal for a new protocol or technology, or an idea for a change to an existing one, that person would create a memorandum describing it and circulate it to others. Since the goal was to solicit comments on the proposal, these memos were called *requests for comments (RFCs)*. Not all RFCs described formalized standards: many were just descriptive documents, clarifications or miscellaneous information.



Note: The documents defining early standards were originally called *Internet Engineering Notes (IENs)* before they were called RFCs.

Today, of course, the Internet is enormous and there is an official [structure of Internet standards organizations](#) that is responsible for creating new Internet and TCP/IP standards. Due to the many thousands of people who play an active role in developing Internet technologies, having an informal system where anyone could just write an RFC would lead to chaos. Thus, Internet and TCP/IP standards are still called RFCs, but the process of creating one is much more formal and organized today.

The Internet Engineering Task Force (IETF) is the standards body that is most directly responsible for the creation of Internet standards. The IETF's working groups, overseen by the Internet Engineering Steering Group (IESG) and the Internet Architecture Board (IAB), develop new protocols and technologies continuously, and these developments are formalized in RFCs.

The publishing of RFCs is handled by the office of the *RFC Editor*. From nearly thirty years, starting in 1969, "the" RFC Editor was Internet pioneer Jon Postel. After his death in 1998, the function was assigned to the Networking Division of the USC Information Sciences Institute (ISI), where Jon Postel was once director. The function of the RFC Editor is to publish and archive RFCs, and maintain an online repository of these documents so that they can be accessed and used by the Internet community.

The open and free access to RFCs has greatly contributed to the Internet's success. If you consider that even today there are standards bodies that charge thousands of dollars for access to a single standard, the ability to log on and immediately retrieve any of the thousands of RFCs is noteworthy.



On The Web: An up-to-date list of RFCs with hyperlinks to each document (except for some of the early ones) can be found at the office of the RFC Editor: <http://www.rfc-editor.org/rfc-index.html>

RFC Categories

As before, not all RFCs are official Internet standards, which is important to remember. Each RFC has a *category* or *status* associated with it that indicates its disposition:

- ☉ **Proposed Standard / Draft Standard / Standard:** These are documents that describe technologies said to be on the "standards track". That means they are either already formally approved as standards, or they are likely to become standards in the future. In many cases, the document is just given as "Standards Track" as opposed to one of those three precise labels. See below for more information.
- ☉ **Best Current Practice:** A document providing guideline information or recommendations from the IETF that is not a formal standard.
- ☉ **Informational:** A document that provides general information or commentary.
- ☉ **Experimental:** A proposal for an experimental standard that is not on the standards track. In some cases, protocols or proposed changes to existing protocols that are not accepted as formal standards are changed to "experimental" status.

-
- 🕒 **Historic:** Former standards that have been obsoleted.

The Internet Standardization Process

The full process for creating and publishing an Internet standard is lengthy and beyond the scope of this Guide. It is interesting, however, so I will outline it here briefly. The full details of the standards process can be found in... where else, an Internet RFC: 2026. 😊

Before a proposal will be considered for the Internet standardization process, it must be published as an *Internet Draft (ID)*. The IETF publishes a set of guidelines that specify how IDs must be created and submitted. Most IDs are written by members of working groups within the IETF who are involved in specific projects. However, since the standards process is open, any member of the public can make an independent submission for review as a standard, by creating an ID for consideration by the IETF and IESG. Internet Drafts are usually revised many times based on feedback from others in various working groups within the IETF.

If an Internet Draft has been reviewed and is considered valuable, well-understood and stable (meaning that it is not being rapidly updated with new revisions) it may become a candidate for standardization. The IESG can place the Draft on the Internet standards track by changing its status to *Proposed Standard*. Documents of this status are considered mostly complete, but may still be revised based on further review, testing and experimentation with the technology.

Once the specification is sufficiently mature and widely accepted, it may be elevated from Proposed Standard to *Draft Standard*. A key requirement for such advancement is that the technology must be demonstrated to be functional on at least two independent and interoperable implementations. This proves that the standard is sufficiently clear and complete that at least two different groups have been able to implement it compatibly.

A document only reaches Draft Standard when the IETF community believes it is technically mature and the specification is complete. Changes are usually made to Draft Standards only to correct problems encountered in testing, or resolve new issues that arise.

The final “station” on the Internet standards track is *Internet Standard*. This designation is only applied to very mature specifications that are popular and that have been widely implemented. A document that reaches this status often describes a technology that is or will become universally-implemented, and is assigned an “STD” (“standard”) number.

The RFC development process can take months or even years, depending on how complex the technology is, how many changes are required to the documents, and whether or not the proposal is considered important or interesting. Many RFCs never make it officially to Internet Standard status; Draft Standard status is generally considered sufficiently stable that the technology is often just implemented by companies when that level is reached. Some RFCs never even make it to Draft Standard status and the technologies they describe are still used in products.

Once an RFC is published, it cannot be changed. This is a specific policy decision intended to avoid the confusion that would otherwise result due to there being multiple versions of the same RFC. The RFC publication process incorporates a number of steps at which RFC authors can revise their documents, and check for editorial omissions and errors.

This need for a new document whenever a change is made is also why proposals are typically published with a category designation of “Standards Track” rather than “Proposed Standard”, “Draft Standard” and “Internet Standard”. This eliminates the need to publish a new RFC that has no changes other than a different category designation, if a proposal advances down the standards track without requiring any real changes.



Key Concept: Internet standards are described in a series of documents called *requests for comments (RFCs)*. The *RFC process* describes how an Internet standard is usually created. An idea for a new technology or enhancement begins with the creation of an *Internet Draft (ID)*. After review and feedback, if the proposal has support, it may be placed on the Internet standards track, and its status changed to *Proposed Standard*. As the fledgling standard matures, its status may advance to *Draft Standard* and eventually, *Internet Standard*. However, many RFCs are implemented in products without reaching *Internet Standard* status. There are also other RFCs that define experimental technologies or provide information without describing official Internet standards.



Backgrounder: Data Representation and the Mathematics of Computing

Humans use decimal (base 10) numbers to represent numeric information, and various alphabets and symbol systems to represent other types of information. In contrast, computers understand only one basic type of information: ones and zeroes, which themselves are representative of either an “on” or “off” electrical or light state within the hardware of the device. These ones and zeroes are combined in various ways to form all the more common data elements we are used to finding in computers: regular numbers, characters and files. However, all of these are really only abstractions; the ones and zeroes are always “underneath” whatever logical structures used within the computer.

This same basic foundation of ones and zeroes applies to networking as well. Even though most of the information in a network is exchanged in a logical fashion between higher-layer protocols, underlying all networking structures are the ones and zeroes sent over the network medium. Understanding how data is represented and manipulated in computer systems is important background information that will help you comprehend many of the different technologies. Not only are computer data representation and mathematics important for explaining how low-level physical layer modulation and encoding techniques work, they come into play even for higher-level concepts, such as how IP addresses are set up and used on the Internet.

In this section I provide some general background information on how numerical data is represented, stored and manipulated within computers and networking hardware. I begin with a description of binary numbers and the different terms used to refer to collections of binary information of various sizes. I describe the different types of numbering systems used in computer systems, such as octal, decimal and hexadecimal, and how data can be converted between these different types. I explain how arithmetic is performed on binary and hexadecimal numbers. I then discuss boolean logic and how logical functions are used to manipulate binary data.

These explanations then form the basis for a discussion of how logical functions are used for setting, clearing, inverting and masking bits. These operations are employed extensively in certain networking technologies and protocols. Masking operations are especially often used in IP addressing, so even though this section seems rather low-level it is quite relevant to the world of TCP/IP.

Needless to say, many of you reading this Guide know most or all of the information in this section, so feel free to skip (or just skim) those topics that you already know. However, I wanted to provide this background detail for the sake of those new to computing, or those needing a refresher. The pages are somewhat long and I try to assume little in the descriptions, so you may want to breeze through the parts that seem familiar. However, even those of you who know what a bit and byte are and the difference between binary and decimal numbers may find the discussion of bit masking worth perusing.



Note: There is only so much detail on the rudimentary basics of computing that I can cover in a Guide of this sort without getting too far afield. If the contents of this section are not sufficient to get you up to speed, I would recommend consulting a more comprehensive reference specific to computing theory and mathematics.

Binary Information and Representation: Bits, Bytes, Nibbles, Octets and Characters

The essence of computing is *information*. Computer hardware and software products are designed to allow the input, storage, transfer and expression of various types of information. A primary way in which types of information are differentiated is based on whether they are *analog* or *digital*. In highly simplified terms, analog information is continuous, while digital is discrete. The distinction between them can be seen by considering, for example, a light switch and a dimmer. A light switch allows a light to be turned on or off only—no “in-between” states. That’s digital information—on or off. In contrast, a dimmer allows you to fine-tune the light output from fully on to fully off, with an infinite number of intermediate states in between: this is analog.

Binary Information

Modern digital computers store all of their information in digital form, because of how they work at a fundamental level. Much the way a light bulb has only an “on” or “off” value, so too do the components that store and manipulate information within computers. Millions of *transistors* comprise computer processors and other circuits, and are, in highly-simplified form, digital switches. Thus, all information in computers is manipulated as collections of information pieces that can be only “on” or “off”, like a switch.

Since there are only two possible states, “on” or “off”, this is called *binary* information (the prefix “bi” meaning “two”, of course.) There are several advantages to using binary representation for information. It is a simple way to represent many types of information, such as the state of a light bulb, or whether a file has been successfully copied, or whether a temperature should be expressed in Celsius or Fahrenheit. It is also possible to collect multiple binary values together to represent more complex information.

Perhaps most importantly, binary information is *unambiguous*. “On” is “on” and “off” is “off”, and this is important as it allows devices to detect clearly the value of a particular piece of information. Computers like black and white; they are not particularly good at dealing with “shades of gray”. This becomes especially important in the field of networking when transmission of data can cause signals to become polluted by noise.

The “on” or “off” condition of a binary value can be expressed in a number of different ways. In logical expressions, we may consider the value to be “true” or “false”. For representing mathematical values, the most common representation is “one” (“on”) or “zero” (“off”).

Binary Information Representation and Groups

The fundamental building block of computer information is the *bit* (a contraction of *binary digit*). Every bit can be either 0 or 1. Making the value of a bit 1 is commonly called *setting* the bit; changing it to 0 is *resetting* or *clearing* it.

Of course, bits represent only a very small amount of information: a single fact or value. We must make collections of these bits so we can use them to store large amounts of information and more complex data types. The most common grouping is to take eight bits and reference them as a single unit. A collection of eight bits is technically called an *octet*, but is more commonly called a *byte*. (More on that in a moment.)

“Byte” is a jocular play on the term “bit”. Over time, other sizes of “bit collections” have also been defined. Some geek comedian decided that if eight bits made a “byte”, then four bits must be a “nybble” (or “nibble”). Hilarious. ☺ Larger collections have also been defined and given various names. [Table 2](#) summarizes the most common representations of groups of bits, and the terms used for them; their relative sizes are also shown graphically in [Figure 8](#).

Table 2: Binary Information Group Representations and Terms

Number of Bits	Common Representation Terms
1	Bit / Digit / Flag
4	Nybble / Nibble
8	Byte / Octet / Character
16	Double Byte / Word
32	Double Word / Long Word
64	Very Long Word

A few of these terms are worth special mention. Bit and byte we have already discussed, of course. A bit is also sometimes called a *flag*; this term is most often heard when a bit is used by itself to represent a particular information state. For example, a computer might use a “changed flag” to represent whether a particular file has been modified; this is an analogy to a flag either being raised or lowered to indicate a condition. These “flags” are often seen in networking message formats.

The term *character* is also used to express a set of eight bits. This use comes from the fact that computers often store alphanumeric characters, such as letters and numbers, one to a byte. The 16-bit *word* is fairly often used, but not nearly as much as “byte”. The larger collections of bits, such as double word and so on, are not often encountered in every-day parlance; they are used to represent chunks of data in technical fields such as hardware design or programming.

You may also have noticed the number of bits used for each of these terms is a power of two. This is of course not a coincidence. As we will see in the subsequent topics in this section, this occurs because when bits come in sets that are a power of two in size, they are

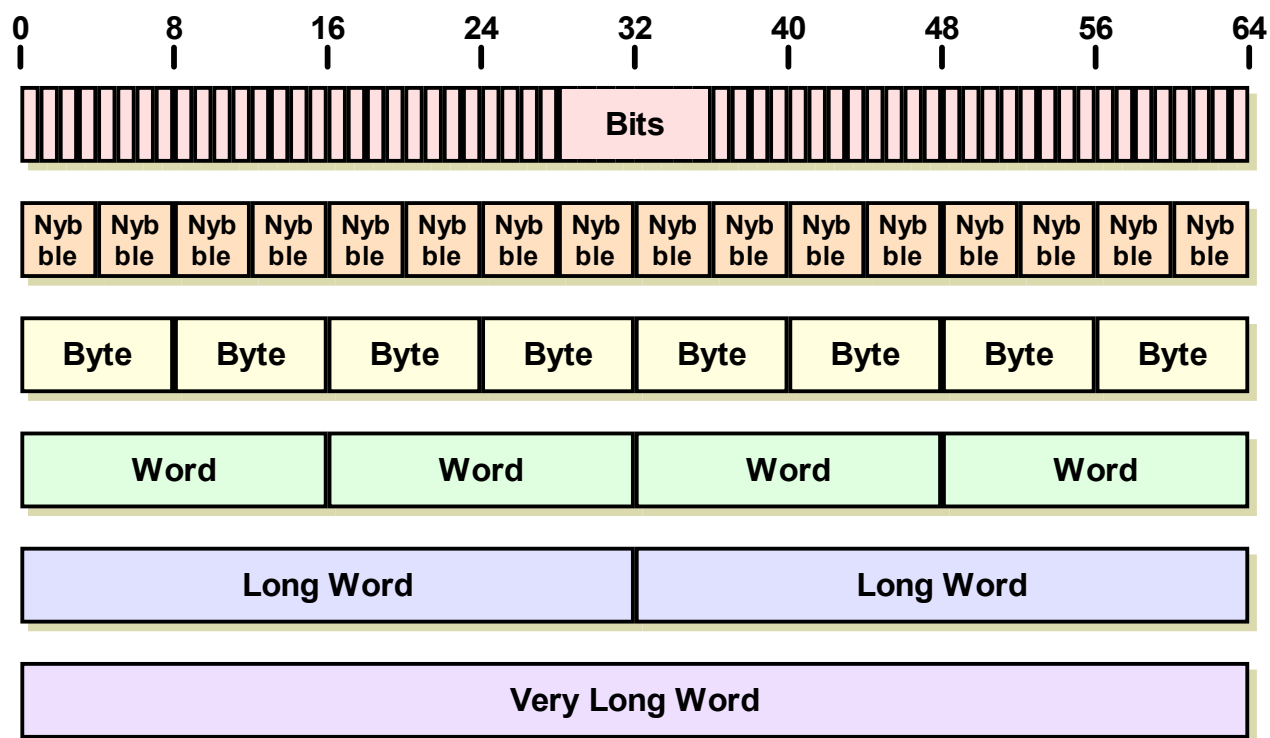

Figure 8: Binary Information Representations and Terms

This diagram shows the relative sizes of the most commonly-sized “collections” of binary information.

easier to represent and manipulate in a convenient manner. The number of bits in the term can itself be easily expressed using binary numbers. This will make more sense after you read [the topic that follows on decimal binary, octal and hexadecimal numbers](#).



Key Concept: Computers store all information in *binary digital* form, which means all data—be it text, photographs, audio or whatever else—is comprised only of collections of ones and zeroes. The fundamental building block of digital information is the *binary digit* or *bit*, which represents a single zero or one state. To represent larger amounts of information, bits can be collected into groups of four, eight, sixteen, 32 or 64, called *nybbles*, *bytes*, *words*, *long words* and *very long words* respectively.

Byte versus Octet

There has been some disagreement, and even controversy, surrounding the use of the words *byte* and *octet*. The former term has traditionally been the most popular in common parlance for a set of eight bits, especially in North America. However, it is **technically** not the correct term.

A byte is, formally, the smallest unit of data that can be read from or written to at one time in a computer system. In almost all cases today, that is indeed eight bits, but there have been some systems where a byte was not eight bits. Some older 36-bit computers used 9-bit bytes, and there were also systems that had byte sizes of 6 or 7 bits, or even variable-sized bytes. For this reason, many people, especially techie professionals, prefer the term *octet*, which clearly and unambiguously implies “eight”. This term is much more common outside North America.

This matter of *octets* and *bytes* is another of the little “tempests in tea pots” that computer people seem to love so much. The bottom line in modern computer systems, however, is that an octet is a byte and a byte in an octet, and the terms can be used interchangeably without too much danger. You will more often see *octets* used in technical standards. In this Guide, I use the term bytes for a simple reason: it is the term that most people are familiar with, including myself (though bear in mind that I live in North America; if I were European I might have rather different views on this!)



Key Concept: Formally, an *octet* is the correct term for exactly eight bits, while a *byte* is the smallest number of bits that can be accessed in a computer system, which may or may not equal eight. In practice, modern computers use 8-bit bytes, and the terms are used interchangeably (with byte being more common in North America, and octet often being preferred in Europe).

Decimal, Binary, Octal and Hexadecimal Numbers

The numbers we are used to using in every-day life are called *decimal numbers*, where the word “decimal” refers to the number ten. The reason for this is rather obvious: every digit can take on one of ten values: 0 to 9. Arithmetic performed on decimal numbers is also called *base 10* mathematics, because of this orientation around the number 10. (Why is the number 10 the foundation of our normal mathematical system? Hold both hands up and count...)

Computer systems, however, don’t have fingers or toes; they deal only with binary numbers. Each bit can represent not a value from 0 to 9, but from, well, 0 to 1. A single “0 or 1” value is sufficient for encoding a single fact, such as whether your car currently is using summer tires or snow tires. It’s not nearly enough to hold more complex information, such as your bank account balance, or a text document, or a picture of the Yellowstone canyon.

Binary Numbers and their Decimal Equivalents

For this reason, larger collections of bits have been defined by computer scientists, such as bytes (octets), words, and so forth. When individual bits are collected into sets in this way, they can be used together to represent larger integers, which are called *binary numbers*. Since there are only two possible values for each digit, binary numbers are also called *base 2* numbers.

A lot of people are intimidated by binary numbers, because at first they seem quite confusing. The key to understanding them is realizing that they are exactly the same as decimal numbers, except that instead of each digit having a value in the range of 0 to 9, each has a value in the range of 0 to 1. For example, when you count in decimal, you go up to 9 in the one's place, and then you need a second place for "tens". If you go above 99, you need a third place for "hundreds". Each additional place added on the left is a higher power of ten. Binary is the same, except the limit for each place is 1 instead of 9. In binary, you go up to 1 in the one's place, and then need a second place for "twos". If you go above 3, you need a third place for "fours". Each added place is a subsequent higher power of two, rather than ten.

Thus, where counting in decimal goes 0, 1, 2, 3, 4, 5, 6, 7, 8, 9, 10, 11, 12, 13 and so on, counting in binary goes 0, 1, 10, 11, 100, 101, 110, 111, 1000, 1001, 1010, 1011, 1100, 1101. The concept is identical—you just need a lot more digits for binary numbers because there are so many fewer values allowed for each digit. For example, the number "13" in decimal is the same as "1101" in binary. How? Well, in decimal, we have a 3 in the one's place, plus a "1" in the "tens" place, which has a value of 10. This is 3+10=13. In binary, we have a "1" in the "ones" place, plus a "1" in the "fours" place, plus a "1" in the "eights" place, which is 1+4+8 or 13.

To take a more complex example, 211 in decimal is 11010011 in binary. [Table 3](#) shows how the two are equivalent, by adding the values for each binary digit place where there is a 1. Read it from left to right, going top to bottom. Starting in the left-most column, we see that the example number has a 1 in the "128s" place. So we start with a sum of 128. In the next column there is a 1 in the "64s" place, so we add 64 for a running sum of 192. But in the "32s" place the binary digit value is 0, so we don't add 32 to the sum. We continue down to the "ones" place to get the decimal equivalent of the binary number.

Table 3: Binary and Decimal Number Equivalents

Binary Number	1	1	0	1	0	0	1	1
Power of Two	2 ⁷	2 ⁶	2 ⁵	2 ⁴	2 ³	2 ²	2 ¹	2 ⁰
Value of Digit Place	128	64	32	16	8	4	2	1
Value For This Number	128	64	0	16	0	0	2	1
Running Sum (from left to right)	128	128+64 = 192	192	192+16 = 208	208	208	208+2 = 210	210+1 = 211

As you can see from this, a binary number with N digits can hold up to 2^N values. So, a byte, with eight bits, can hold 2⁸ or 256 different values, which are numbered from 0 to 255. A 16-bit word can hold 2¹⁶ or 65,536 values.

Making Binary Numbers Easier to Use By Grouping Bits

One problem with binary numbers is that while computers love them, they are unintuitive for humans, who are used to decimal numbers. One reason for this is that they quickly get very, very long and cumbersome to deal with. For example, 1,000,000 in decimal is

1111010001001000000 in binary. To make binary numbers easier to work with, two different shorthand notations have been defined. In both of these, instead of working with each bit individually, they are collected into subgroups, each of which is assigned a single digit in an alternative numbering system.

Octal Numbers

Let's take the binary number 11110100, which is 244 in decimal. Now, instead of looking at each bit individually, let's chop them into groups of three, starting from the right. So, 11110100 becomes (11)(110)(100). Now, each of those groups has three bits, so each can have 2^3 values: from 0 to 7. In this case, (11)(110)(100) = (3)(6)(4), or 364 in the *octal* or *base-8* numbering system (see [Figure 9](#)). Just as with binary, octal numbers are the same as decimal numbers, except they are base 8 instead of base 10. So, 364 in octal is just 3 times 64 plus 6 times 8 plus 4, or 244. The advantage that octal has over binary is obvious: it's a lot less cumbersome to deal with larger numbers. 1,000,000 in decimal is 3641100 in octal.

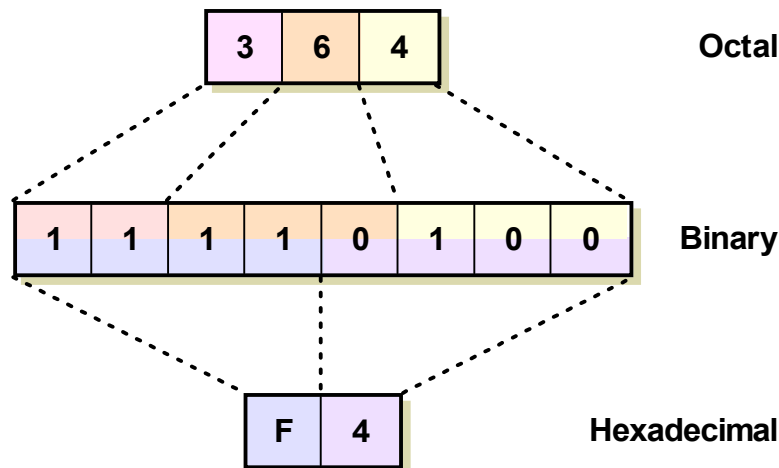

Figure 9: Binary, Octal and Hexadecimal Number Representations

A binary number can be represented in octal form by grouping its bits into sets of three, or in hexadecimal by using sets of four bits. These base-8 and base-16 numbers have the advantage of being far shorter than binary numbers, and hence much easier to work with.

Hexadecimal Numbers

Octal numbers were at one time quite commonly used, but are much less popular today. The problem with octal is that it divides bits into groups of three, but sets of binary numbers typically use a number of bits that is a multiple of *four*. An alternative method was defined that does the same thing but using groups of four. Since there are four bits in each group, each can have one of sixteen values, and this is called the *hexadecimal* or *base 16* numbering system. It is also commonly called just *hex* for short.



Note: As an interesting “sidebar”, the term *hexadecimal* was not the first one used for base-16 numbers in computing. Originally, these were called *sexadecimal* numbers. This is actually the correct term, since Latin prefixes (*sexa-*) are normally used for numbers, not Greek ones (*hexa-*). However, in the early 1950s, IBM decided that the word “sexadecimal” was just a little too “provocative” for their tastes, so they changed it to *hexadecimal*. IBM being IBM—especially back then—meant everyone else followed suit. As I understand it, neither term is etymologically perfect, but well, this note is long enough already. 😊

Now, let's go back to the example just above, 11110100 in binary, 244 in decimal. We divide this into groups of four, to get (1111)(0100). The binary value “1111” is 15, and “0100” is four, so we have (15)(4). Hmm, now we have a bit of a problem, don't we? We need to be able to represent “15”, but we only have 10 numerals. To get around this, in hexadecimal numbers the values 10, 11, 12, 13, 14, or 15 are represented by the letters “A”, “B”, “C”, “D”, “E” and “F” respectively. So, 11110100 in binary is (15)(4), or “F4” in hexadecimal (also shown in [Figure 9](#)).

Hexadecimal numbers are in some ways even less intuitive than binary ones. After all, it takes some practice to get used to thinking of letters as numbers. However, they are very useful due to the way they compactly represent binary information. Where 1,000,000 in decimal is 11110100001001000000 in binary, it is only “F4240” in hexadecimal—even shorter than the decimal number, since 16 is larger than 10. Also, a single byte has eight bits, so it can be represented using only two hexadecimal digits. Due to this convenience factor, hex numbers are widely used in the field of computing, including networking. For example, you will often see values expressed in hexadecimal for items such as MAC addresses, and for representing different types of information in frame or packet formats.



Key Concept: Regular numbers are called *decimal numbers* because they are built upon our base-10 system of mathematics. Computers use collections of one-or-zero bits called *binary numbers*, which can be treated just like regular numbers except that each digit can only be 0 or 1 instead of 0 to 9. Bits in a binary number can be expressed as *octal numbers* by grouping three bits into an octal digit that ranges from 0 to 7, or taking sets of four bits to create a single *hexadecimal* digit from 0 to 15. To represent the values 10 through 15 in hexadecimal using a single character, the letters A through F are used.

If you see a number that has a letter from “A” to “F” in it, you know it is a hex number, but not all hex numbers have those digits. Hex numbers are usually displayed in a special notation, to avoid confusing them with decimal numbers. That notation is either a prefix of “0x” or a suffix of “h” (sometimes both). Thus, the number “54” is just “54”, but “0x54” is “54” in hexadecimal, which is 5 times 16 plus 4, or “84” in decimal. Be sure to watch for these representations.

Decimal, Binary, Octal and Hexadecimal Number Conversion

Humans are accustomed to dealing with decimal numbers, while computers use binary digits. Octal and hexadecimal numbers are “short forms” for binary numbers, where each hexadecimal digit takes the place of either three or four binary digits. Since people and computers speak different “number languages”, it is often necessary to convert numbers from one of these systems to the other. If you spend any amount of time dealing with computers or networks, you will find yourself needing to do this on occasion, so it's worth taking a quick look at how it is done.

First of all, let me say this: the easiest way to convert between decimal, binary, octal and hexadecimal numbers is to use a scientific calculator. This is what most people do, and I highly recommend it. However, there are cases where you may need to be able to do this by hand—we don't all always have a calculator on us. Also, understanding the manual conversion process will help you comprehend more intuitively how binary, octal and hexadecimal numbers work. So, let's take a look.



Note: If you don't have a scientific calculator, there is a reasonable facsimile built into most versions of Windows: the *Calculator* program, which can usually be found in your Accessories folder. Open it, go to the *View* menu, and change the setting from “Standard” to “Scientific”. Click the button next to a numbering system. Then enter a number, and if you click a button next to a different numbering type, the number will be converted for you. Easy. (I would bet Apple and UNIX machines have similar tools, I just have more experience with Windows.)

Conversions Between Binary, Octal and Hexadecimal

Okay, let's start with the easy stuff first. Conversion between binary, octal and hexadecimal is very simple, as you may have noticed in [the preceding topic, where I introduced them](#). Each octal digit is three binary digits, and each hexadecimal digit is four binary digits. Thus, to convert from binary to octal or hex, just group the digits, and convert each group into an octal or hex digit. To go the other way, convert each hex or octal digit into a set of bits. [Table 4](#) shows the conversions from each of the octal and hexadecimal single-digit values to binary (with decimal digits thrown in for convenience):

Table 4: Binary, Octal and Hexadecimal Digit Conversion (Page 1 of 2)

Binary Digits	Octal Digit	Hexadecimal Digit	Decimal Digit
0000	0	0	0
0001	1	1	1
0010	2	2	2
0011	3	3	3
0100	4	4	4

Table 4: Binary, Octal and Hexadecimal Digit Conversion (Page 2 of 2)

Binary Digits	Octal Digit	Hexadecimal Digit	Decimal Digit
0101	5	5	5
0110	6	6	6
0111	7	7	7
1000		8	8
1001		9	9
1010		A	
1011		B	
1100		C	
1101		D	
1110		E	
1111		F	

Let's look at some specific examples using larger numbers:

- Binary to Octal:** Suppose we start with the binary number 110101001010. We divide this into groups of three: (110)(101)(001)(010). Each of these, we convert to a number from 0 to 7 (which is easy to do in your head if you practice a bit). The result is (6)(5)(1)(2) or 6512 octal.
- Hexadecimal to Binary:** Let's start with the hex number 0x4D1B. We convert each digit as given in the table above. So, we have 0x4D1B = (0100)(1101)(0001)(1011) or 0100110100011011.

Conversions From Binary, Octal and Hexadecimal to Decimal

Conversions to and from decimal are more complicated than conversions between binary, octal and hexadecimal, because 2, 8 and 16 are powers of two but ten is not. Of the two directions, conversions **to** decimal are easier: you take the value of each binary, octal or hexadecimal digit, convert it to decimal, and then multiply it by the power of 2, 8 or 16 represented by the digit's place in the number. Then you add all the numbers together. I did this in [the previous topic](#) with the example of the decimal number 211 (see [Table 3](#)).

Let's take an example of going from hexadecimal to decimal. [Table 5](#) shows the hexadecimal number 0x830C converted to decimal (octal uses a similar process). Read the table from left to right, top to bottom; each digit's value is multiplied by the appropriate power of 16 and added together, yielding the result 33,548 decimal.

Table 5: Hexadecimal to Decimal Number Conversion (Page 1 of 2)

Hexadecimal Number	8	3	0	C
Decimal Value of Digit	8	3	0	12

Table 5: Hexadecimal to Decimal Number Conversion (Page 2 of 2)

Power of 16	16^3	16^2	16^1	16^0
Value of Digit Place	4096	256	16	1
Value For This Number	$4096 * 8 = 32768$	$3 * 256 = 768$	$0 * 16 = 0$	$12 * 1 = 12$
Running Sum (from left to right)	32768	$32768 + 768 = 33536$	33536	$33536 + 12 = \mathbf{33548}$

Conversions From Decimal to Binary, Octal and Hexadecimal

Now let's consider conversions *from* decimal. These require that you perform the opposite of the calculation above: you divide and subtract instead of multiplying and adding.

Conversion From Decimal to Binary

The easiest of the three conversions from decimal is to binary—since the maximum value of each digit is one, there is no dividing, just subtraction. All you do is the following:

1. Find the largest power of two that is smaller than the number.
2. Put a “1” in the digit place for that power of two and subtract that power of two from the decimal number.
3. Repeat steps #1 and #2 until you are reduced to zero.

This is easier to explain using an example and a table, of course. Let's convert the decimal number 689, as shown in [Table 6](#). Again, read the table starting from the upper left, and going down and then across. We start by noticing that 1024 is not less than or equal to 689, so the “1024s” place gets a 0. In the next place, 512 is less than 689, so we make the “512s” place a 1 and subtract 512 from 689 to leave 177. The calculation continues, eventually showing shows that 689 decimal is 1010110001 binary.

Table 6: Decimal to Binary Number Conversion

Decimal Value Before Considering This Digit Place	689	689	177	177	49	49	17	1	1	1	1
Power of Two	2^{10}	2^9	2^8	2^7	2^6	2^5	2^4	2^3	2^2	2^1	2^0
Value of Digit Place	1024	512	256	128	64	32	16	8	4	2	1
Value of Digit Place Equal To or Less Than Current Decimal Number?	No	Yes	No	Yes	No	Yes	Yes	No	No	No	Yes
Subtraction Step	skip	689-512 = 177	skip	177-128 = 49	skip	49-32 = 17	17-16 = 1	skip	skip	skip	1-1 = 0
Binary Digits	0	1	0	1	0	1	1	0	0	0	1

Conversion From Decimal to Octal or Hexadecimal

The process for octal and hexadecimal is almost the same, except you must divide by powers of two instead of just subtracting:

1. Start with the highest power of 16 (hexadecimal) or 8 (octal) that is smaller than the number.
2. Divide the decimal number by that power, keeping only the integer part of the result.
3. Keep the remainder after the division is done, for the next step.
4. Repeat steps #1 to #3 until you get to the “ones” place, and then put there whatever is left after the higher digits were done.

Table 7 shows the same example as Table 6 but goes from decimal to hexadecimal instead of decimal to binary: 689 in decimal is 0x2B1 hexadecimal.

Table 7: Decimal to Hexadecimal Number Conversion

Decimal Value Before Considering This Digit Place	689	689	177	1
Power of 16	16^3	16^2	16^1	16^0
Value of Digit Place	4096	256	16	1
Value of Digit Place Smaller Than Current Decimal Number?	No	Yes	No	n/a
Division Step	skip	689/256 = 2.691; use “2” for this digit.	177/16 = 11.0625; use “B” for this digit.	n/a
Remainder After Division	skip	177	1	n/a
Hexadecimal Digits	0	2	B	1

Binary, Octal and Hexadecimal Arithmetic

Many of us use arithmetic every day as part of our regular lives without really noticing it, to give us the information we need to make decisions. In a similar way, computers perform arithmetic operations all the time as part of their normal operation. The main differences between how computers do it and how we do it are two-fold: computers use binary numbers, and computers are *much* faster.

As I said in my [introduction to binary, octal and hexadecimal numbers](#), those forms are different representations of numbers, and are not really much different than decimal numbers. They just have a different number of values per digit. In a similar vein, arithmetic with binary, octal or hexadecimal numbers is not that much different from the equivalent operations with decimal numbers. You just have to keep in mind that you are working with powers of 2, 8 or 16, instead of 10, which isn't always easy to do.

As was the case with [conversions](#), calculators are usually the way to go if you need to do math with binary, octal or hexadecimal numbers. If your calculator only does math with decimal numbers, one trick is to convert the numbers to decimal, then perform the operation, and convert back the result. However, you can fairly easily do the same addition, subtraction, multiplication and division on binary, octal or hex numbers that you do with decimal numbers, by using the Windows *Calculator* program or equivalent.

Multiplication and division of binary numbers is a common operation within computers, but isn't a calculation that often needs to be done by people who are working with them. Addition and subtraction are much more common (especially addition), and have the added bonus of being much easier to explain. You probably won't need to do this type of arithmetic that often, but it's good to understand it, at least a little. I am going to provide just a couple of examples to give you the general idea.

Binary Arithmetic

Let's start with binary. Adding binary numbers is the same as adding decimal ones, but you end up doing a *lot* of carrying of ones since there are so few values allowed per digit. [Table 8](#) shows an example, with one digit in each column; read it from right to left and top to bottom, just as you would usually do manual addition. So we start by adding the "1" in the "ones" place from the first number with the "1" in that place from the second number, yielding a raw digit sum of 2. This means the result for the "ones" digit is "1" and we carry a 1 to the "twos" place. We continue with this process until we have added all the digits.

Table 8: Binary Addition

Carry		1	1			1	1	—
First Binary Number	1	0	1	1	0	0	1	1
Second Binary Number	0	0	1	1	1	0	0	1
Raw Digit Sum	1	1	3	2	1	1	2	2

Table 8: Binary Addition

Result	1	1	1	0	1	1	0	0
Carry to Next Higher Digit			1	1			1	1

Octal and Hexadecimal Arithmetic

Octal and hexadecimal are pretty much the same, except that you carry if the sum in a particular digit exceeds either 8 or 16, respectively. Hexadecimal is more common, and more interesting, so let's take an example of adding two hex numbers together. While performing the operation, you will need to do conversions of single-digit hex numbers to decimal and back again, but this isn't too difficult.

This example is shown in [Table 9](#), which again should be read from right to left. We start by adding "8" (decimal 8) to "A" (decimal 10) in the "ones" place. This yields a raw sum of 18, from which we carry 16 as a "1" to the "16s" place and leave a result of 2. We add this 1 to the "D" (value 13) and "E" (14 value) of the "16s" place. This is a total of 28, leaving 12 ("C" in hexadecimal) and we carry a 1 to the "256s" place. This continues until we are left with a sum of 6DC2h.

Table 9: Hexadecimal Addition

Carry		1	1	
First Hex Number	2	C	D	8
Second Hex Number	4	0	E	A
Raw Digit Sum	2+4 = 6	1+12+0 = 13	1+13+14 = 28	8+10 = 18
Result	6	D	C	2
Carry to Next Higher Digit			1	1

Boolean Logic and Logical Functions

Every bit in a computer system can hold a value of either "one" or "zero", which represent the basic "on" or "off" states inherent in a binary digital system. In the preceding topics in this section, I demonstrated how groups of these bits can be collected into sets to represent larger binary numbers, and then how those can be used for performing various mathematical operations.

However, as I mentioned when I [introduced the concept of binary information](#), we can also interpret the "on" and "off" values of a binary digit as "true" or "false" respectively. These can represent various logical conditions within a computer or other system. Furthermore, there are various logical operations that can be used to manipulate and combine these "true" or "false" values to represent more complex logical states. One of the pioneers of using binary values in logical thought was British mathematician George Boole (1815-1864), and in recognition of his contribution to this field, this system of binary values and conditions is commonly called *boolean logic*.

Boolean Logical Functions

Boolean logic defines a number of *boolean logical functions*, which are also sometimes called *operators*. Each of these uses a logical algorithm to compute an output value based on the value of one or more inputs. The algorithm determines when the output is a “true” value, based on what combination of “true” and “false” values the inputs take. For this reason, the table that shows the inputs and outputs for a logical function is called a *truth table*. Each of the logical functions is analogous to a “real world” logical operation that we use to define various logical situations, as we will see.

It is much easier to see how boolean logic works by looking at examples, rather than reading these types of formal descriptions. So, let's just jump right in and see it in action, by looking at the different functions and how they work.

The *NOT* Function

Let's start with the simplest, the *NOT function*. As you might expect, this is just a negation; the output is the opposite of the input. The *NOT* function takes only one input, so it is called a *unary* function or operator. The truth table for *NOT* is shown in [Table 10](#). As you can see, the output is true when the input is false, and vice-versa.

Table 10: *NOT* Operator Truth Table

Input	Output
False	True
True	False

The *NOT* function logically represents the opposite of a condition. For example, suppose we have a bit called “B1” whose logical meaning is that when the bit is “true”, a particular pixel on a screen is lit up. Then the *boolean expression* “NOT B1” would be the opposite: it would be false when the pixel is lit up, and thus true only when the pixel is *not* lit up. Pretty straight-forward.

Now, before proceeding further, I am going to play a little trick on you. ☺ As I said above, boolean logic is based on “true” and “false” values. However, I also said that “true” and “false” are represented in computers by “one” or “zero” values. For this reason, boolean logic is often expressed in terms of ones and zeroes, instead of “true” and “false”. The circuits inside computer processors and other devices manipulate one and zero bits directly using these functions. In some (but not all) cases they interpret “one” and “zero” as “true” and “false”, but in either case the two representations are functionally equivalent.

Table 11 shows the same truth table as Table 10, but using bit values: each "True" is represented as a 1 and each "False" as a 0.

Table 11: NOT Operator Truth Table (Using Bit Values)

Input	Output
0	1
1	0

The AND and OR Functions

There are two other primary boolean functions that are widely used: the *AND function* and the *OR function*. The output of an *AND* function is true only if its first input **and** its second input **and** its third input (etc.) are all true. The output of an *OR* function is true if the first input is true **or** the second input is true **or** the third input is true (again, etc.)

Both *AND* and *OR* can have any number of inputs, with a minimum of two. Table 12 shows the truth table for the *AND* function, with two inputs. You can see that the output is a 1 only when both inputs are 1, and is 0 otherwise.

Table 12: AND Operator Truth Table

Input #1	Input #2	Output
0	0	0
0	1	0
1	0	0
1	1	1

Like the *NOT* function, the *AND* function represents a logical operation similar to how we use the word in our every day lives. For example, at lunch time, I might suggest to a colleague "let's go out for lunch *and* stop at the post office".

The truth table for the *OR* function (again with two inputs) is shown in Table 13. Here, the output is 1 whenever a 1 appears in at least one input, not necessarily both as in the previous table.

Table 13: OR Operator Truth Table

Input #1	Input #2	Output
0	0	0
0	1	1
1	0	1
1	1	1

Interestingly, unlike the *AND* function, the boolean *OR* function in fact does **not** have the same meaning as the way that we routinely use the word “or” in English. When we say “or”, we usually mean one “or” the other, but not both: “you can have apple pie *or* chocolate cake for dessert”. In the boolean *OR* however, the output is true as long as **any** of the inputs is true, even if more than one is.

Exclusive-OR (*XOR* or *EOR*)

A modification of *OR* called *Exclusive-OR* (abbreviated either *XOR* or *EOR*) represents the way we normally use “or” in the real world. Its output is only true if one input is true or the other, but **not both**. The truth table for *XOR* is as shown in [Table 14](#). Notice the difference between this table and [Table 13](#): the output is 0 in the case where both inputs is 1.

Table 14: Exclusive OR (*XOR*) Operator Truth Table

Input #1	Input #2	Output
0	0	0
0	1	1
1	0	1
1	1	0

Combining Boolean Functions to Create Boolean Expressions

The functions described above can also be combined in arbitrary ways to produce more complex logical conditions. Boolean logic expressions are used in many different contexts in the computing field. A common place that most people use them is in a World Wide Web search engine. For example, if you enter “cheese *AND* (cheddar *OR* swiss) *NOT* wisconsin” into a search engine, the program will return pages that contain the word “cheese” that also contain the word “cheddar” or “swiss” (or both), but that do **not** contain the word “wisconsin”.

(Sorry, Wisconsinite cheese lovers—but I live in Vermont! ☺)

Boolean functions are the building blocks of much of the circuitry within computer hardware. The functions are implemented as tiny *gates* that are designed to allow electrical energy to flow to the output only based on certain combinations of inputs as described by the truth tables for functions like *NOT*, *AND*, *OR* and others. In networking, boolean logic is important for describing certain conditions and functions in the operation of networks. Boolean functions are also very important because they are used to set, clear and mask strings of binary digits, which we will explore in the next topic.



Key Concept: *Boolean logic* is a system that uses boolean functions to produce outputs based on varying conditions in their input data. The most common boolean functions are *NOT*, which produces as output the opposite of its input; *AND*, which is true (1) only if all of its inputs are true (1); *OR*, which is true if any of its inputs is true; and *XOR*, which is true only if exactly one of its inputs is true (or put another way, if the inputs are different). These functions can be used in boolean logic expressions that represent conditional states for making decisions, and can also be used for bit manipulation.

Bit Masking (Setting, Clearing and Inverting) Using Boolean Logical Functions

The [boolean functions](#) *NOT*, *AND*, *OR* and *XOR* describe different ways that logical expressions can be used to manipulate “true” and “false” values to represent both simple and complex decisions or conditions. However, these functions can also be used in a more mundane manner, to allow the direct manipulation of binary data. This use of boolean logic is very important in a number of different applications in networking.

As I mentioned in [the topic introducing binary numbers](#), giving a bit a value of one is called *setting* the bit, while giving it a value of zero is either *resetting* or *clearing* it. In some situations bits are handled “individually”, and are set or cleared simply by assigning a one or zero value to each bit. However, it is common to have large groups of bits that are used collectively to represent a great deal of information, where many bits need to be set or cleared at once. In this situation, the boolean functions “come to the rescue”.

Setting Groups of Bits Using the OR Function

Setting bits en masse can be done by exploiting the properties of the *OR* function. Recall that the *OR* function's output is true (one) if any of its inputs is true (one). Thus, if you “OR” a bit with a value known to be one, the result is always going to be a one, no matter what the other value is. In contrast, if you “OR” with a zero, the original value, one or zero, is not changed.

By using a string with zeroes and ones in particular spots, you can set certain bits to 1 while leaving others unchanged. This procedure is comparable to how a painter masks areas that he does not want to be painted, using plastic or perhaps masking tape. Thus, the process is called *masking*. The string of digits used in the operation is called the *bit mask*, or more simply, just the *mask*.

An example will illustrate. Suppose we have the 12-bit binary input number 101001011010, and we want to set the middle six bits to be all ones. To do this, we simply *OR* the number with the 12-bit mask 00011111000. [Table 15](#) shows how this works, with the changed bits in the result highlighted—we simply *OR* each bit in the input with its corresponding bit in the mask:

Table 15: Setting Bits Using an *OR* Bit Mask

Input	1	0	1	0	0	1	0	1	1	0	1	0
Mask	0	0	0	1	1	1	1	1	1	0	0	0
Result of OR Operation	1	0	1	1	1	1	1	1	1	0	1	0

Clearing Groups of Bits Using the AND Function

To clear a certain pattern of bits, you do a similar masking operation, but using the *AND* function instead. If you *AND* a bit with zero, it will clear it to zero regardless of what the bit was before, while *AND*ing with one will leave the bit unchanged. So, to take the same example above and clear the middle six bits, we *AND* with the reverse bit mask, 11100000111. This is shown in [Table 16](#) and illustrated in [Figure 10](#).

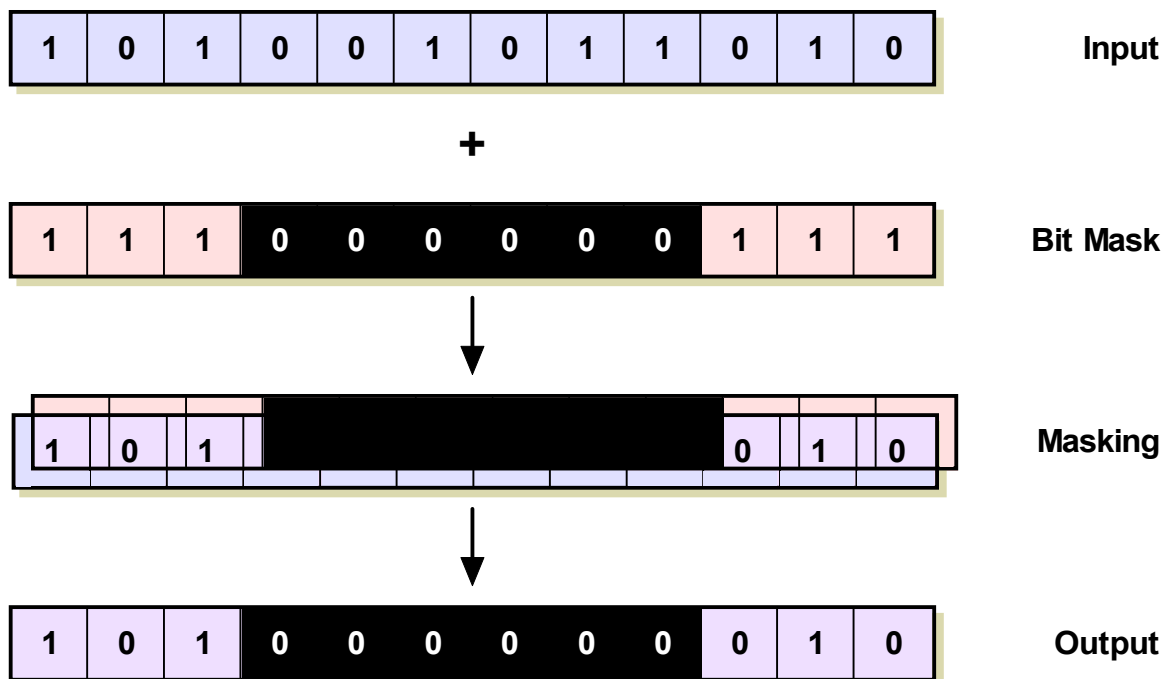

Figure 10: Clearing Bits Using an *AND* Bit Mask

This diagram shows how a bit mask can be used to clear certain bits in a binary number while preserving others. The mask shown here can be likened to a painter’s mask; each 1 represents a “transparent” area that keeps the corresponding input bit value, while each 0 is a bit where the original value is to be cleared. After performing an *AND* on each bit pair, the first three and last three bits are preserved while the middle six, since they were each *AND*ed with 0, are forced to 0 in the output.

Table 16: Clearing Bits Using an AND Bit Mask

Input	1	0	1	0	0	1	0	1	1	0	1	0
Mask	1	1	1	0	0	0	0	0	0	1	1	1
Result of AND Operation	1	0	1	0	0	0	0	0	0	0	1	0

We can also look at this “clearing” function a different way. We are clearing the bits where the mask is a zero, and in so doing “selecting” the bits where the mask is a one. Thus, *AND*ing with a bit mask means that you “keep” the bits where the mask is a one and “remove” the bits where it is a zero.

Inverting Groups of Bits Using the XOR Function

There are also situations in which we want to *invert* some bits; that is, change a one value to a zero, or a zero value to a one. To do this, we use the *XOR* function. While this is not as intuitive as the way masking works with *OR* and *AND*, if you refer to the *XOR* truth table (Table 14) you will see that if you *XOR* with a one, the input value is flipped, while *XOR*ing with a zero causes the input to be unchanged. To see how this works, let's take the same input example and invert the middle six bits, as shown in Table 17.

Table 17: Inverting Bits Using an XOR Bit Mask

Input	1	0	1	0	0	1	0	1	1	0	1	0
Mask	0	0	0	1	1	1	1	1	1	0	0	0
Result of XOR Operation	1	0	1	1	1	0	1	0	0	0	1	0

In the world of networking, bit masking is most commonly used for the manipulation of addresses. In particular, masking is perhaps best known for its use in differentiating between the host and subnetwork (subnet) portions of [Internet Protocol \(IP\) addresses](#), a process called *subnet masking* and described in [the section on IP subnet addressing](#).



Note: Masks are often expressed in either hexadecimal or decimal notation for simplicity of expression, as shown in the [IP subnetting summary tables](#). However, the masks are always applied in binary, as described above. You should convert the mask to binary if you want to see exactly how the masking operation is going to work.



Key Concept: The properties of the *OR* and *AND* boolean functions make them useful when certain bits of a data item need to be set (changed to 1) or cleared (changed to 0), a process called *bit masking*. To set bits to one, a mask is created and used in a bit-by-bit *OR* with the input; where the mask has a value of 1, the bit is forced to a 1, while each 0 bit leaves the corresponding original bit unchanged. Similarly, a mask used with *AND* clears certain bits; each 1 bit in the mask leaves the original bit alone, while each 0 forces the output to 0. Finally, *XOR* can be used to invert selected bits using a mask.



The Open System Interconnection (OSI) Reference Model

Models are useful because they help us understand difficult concepts and complicated systems. When it comes to networking, there are several models that are used to explain the roles played by various technologies, and how they interact. Of these, the most popular and commonly used is the *Open Systems Interconnection (OSI) Reference Model*.

The idea behind the OSI Reference Model is to provide a framework for both designing networking systems and for explaining how they work. As you read about networking, you will frequently find references to the various levels, or *layers*, of the OSI Reference Model. The existence of the model makes it easier for networks to be analyzed, designed, built and rearranged, by allowing them to be considered as modular pieces that interact in predictable ways, rather than enormous, complex monoliths.

In fact, it's pretty much impossible to read a lot about networking without encountering discussions that presume at least some knowledge of how the OSI Reference Model works. This is why I strongly advise that if you are new to the OSI Reference Model, you read this chapter carefully. While it is all arguably “background material”, reading it will help form an important foundation in your understanding of networks, and will make the rest of the Guide make more sense at the same time.

If you are quite familiar with the OSI Reference Model, you may wish to skip this chapter of the Guide, or just skim through it. You can always return later to brush up on particular issues, as needed. There are also many links that come back to the descriptions of the individual layers from various parts of the Guide.

In the pages that follow, I describe the OSI Reference Model in detail. I begin with a history of the model, and a discussion of some general concepts related to the OSI model and networking models overall. I provide a useful analogy to help you understand how the reference model works to explain the interaction of networks on multiple levels. I then describe each of the seven layers of the OSI Reference Model, and conclude with a summary of the layers and their respective functions.



Note: This section describing the OSI Reference Model is geared to a discussion of networks and internetworks in general, and not specifically to the TCP/IP protocol suite. Therefore, not all of the material in this section is directly relevant to learning about TCP/IP, though much of it is. You may also wish to refer to [the topic covering the reference model that describes TCP/IP](#), which also discusses how the TCP/IP and OSI models compare.

History of the OSI Reference Model

Looking at the origins of the OSI Reference Model takes us back to several issues that were discussed in the [Networking Fundamentals](#) chapter of this Guide; specifically, I am talking about [standards and standards organizations](#). The idea behind the creation of networking standards is to define widely-accepted ways of setting up networks and connecting them together. The OSI Reference Model represented an early attempt to get all of the various hardware and software manufacturers to agree on a framework for developing various networking technologies.

In the late 1970s, two projects began independently, with the same goal: to define a unifying standard for the architecture of networking systems. One was administered by the *International Organization for Standardization (ISO)*, while the other was undertaken by the *International Telegraph and Telephone Consultative Committee*, or *CCITT* (the abbreviation is from the French version of the name). These two [international standards bodies](#) each developed a document that defined similar networking models.

In 1983, these two documents were merged together to form a standard called *The Basic Reference Model for Open Systems Interconnection*. That's a mouthful, so the standard is usually referred to as the *Open Systems Interconnection Reference Model*, the *OSI Reference Model*, or even just the *OSI Model*. It was published in 1984 by both the ISO, as standard ISO 7498, and the renamed CCITT (now called the *Telecommunications Standardization Sector of the International Telecommunication Union* or *ITU-T*) as standard X.200. (Incidentally, isn't the new name for the CCITT **much** catchier than the old one? Just rolls off the old tongue, doesn't it. ☺)

One interesting aspect of the history of the OSI Reference Model is that the original objective was **not** to create a model primarily for educational purposes—even though many people today think that this was the case. The OSI Reference Model was intended to serve as the foundation for the establishment of a widely-adopted suite of protocols that would be used by international internetworks—basically, what the Internet became. This was called, unsurprisingly, the OSI Protocol Suite.

However, things didn't quite work out as planned. The rise in popularity of the Internet and its [TCP/IP protocols](#) met the OSI suite head on, and in a nutshell, TCP/IP won. Some of the OSI protocols were implemented, but as a whole, the OSI protocols lost out to TCP/IP when the Internet started to grow.

The OSI model itself, however, found a home as a device for explaining the operation of not just the OSI protocols, but networking in general terms. It was used widely as an educational tool—much as I use it myself in this Guide—and also to help describe interactions between the components of other protocol suites and even hardware devices. While most technologies were not designed specifically to meet the dictates of the OSI model, many are described in terms of how they fit into its layers. This includes networking protocols, software applications, and even different types of hardware devices, such as switches and

routers. The model is also useful to those who develop software and hardware products, by helping to make clear the roles performed by each of the components in a networking system.



Key Concept: The *Open Systems Interconnection Reference Model (OSI Reference Model or OSI Model)* was originally created as the basis for designing a universal set of protocols called the *OSI Protocol Suite*. This suite never achieved widespread success, but the model became a very useful tool for both education and development. The model defines a set of layers and a number of concepts for their use that make understanding networks easier.



General Reference Model Issues

Before getting into the details of how the OSI Reference Model works, I think it is a good idea to first discuss some of the basic issues related to reference models. In part, I want to explain why I place so much emphasis on the OSI model in this Guide, even going so far as to organize much of the document on the basis of this model. I also want you to understand why the model is important, and how it benefits networking not only on a conceptual level, but in reality as well.

So, in this section I describe several issues that relate to reference models in general terms, and of course, to the OSI Reference Model as well. I begin with some overview explanation of why networking models are beneficial, and why it is important for you to understand how the OSI model works. I then talk about how best to use the OSI Reference Model, and also contrast it to some “real-world” network architectures and protocol stacks.

The Benefits of Networking Models

In my [introduction to this Guide](#), I said that networking was complicated—in fact, I probably said it too often. ☺ Well, I wouldn't lie to you—it is. And in fact, it is for that exact reason that special pains must be taken to try to *simplify* it. One of the ways in which networking technology is made easier to understand is by splitting it into pieces, each of which plays a particular role, or is responsible for a specific job or function.

However, if this is to be done, we must have a way of ensuring that these various pieces can interoperate; that is, each must know what is expected of it, and also what it can expect from the other pieces. This is one of the important roles of networking models. They split the multitude of tasks required to implement modern networks, into smaller chunks that can be more easily managed. Just as importantly, they establish “walls” between those pieces, and rules for passing information over those walls.

A good analogy of a networking model is to that of an assembly line at a manufacturer. No company attempts to have one person build an entire car; even if they did, they wouldn't expect that individual to be able to learn how to do it all at once. The division of labor offers several advantages to a company that builds a complex product, such as an automobile. Generally speaking, these include the following:

- ☉ **Training and Documentation:** It is easier to explain how to build a complex system by breaking the process into smaller parts. Training can be done for a specific job without everyone needing to know how everything else works.
- ☉ **Specialization:** If everyone is responsible for doing every job, nobody gets enough experience to become an expert at anything. Through specialization, certain individuals develop expertise at particular jobs.

-
- ☉ **Easier Design Modification and Enhancement:** Separating the automobile into systems, and particular jobs required to build those systems, makes it easier to make changes in the future. Without such divisions, it would be much more difficult to determine what the impact might be of a change, which would serve as a disincentive for innovation.
 - ☉ **Modularity:** This is related to each of the items above. If the automobile's systems and manufacturing steps are broken down according to a sensible architecture or model, it becomes easier to interchange parts and procedures between vehicles. This saves time and money.

Networking models yield very similar benefits to the networking world. They represent a framework for dividing up the tasks needed to implement a network, by splitting the work into different levels, or *layers*. Hardware and software running at each layer is responsible for interacting with its corresponding hardware and software running on other devices at the same layer. The responsibilities of each hardware or software element are defined in part by specifically delineating lines that exist between the layers.

The result is that you get all of the benefits listed in the bullet points above: easier training, specialized capabilities at each layer, improved capabilities for modification, and modularity. Modularity is particularly important, as it allows you to interchange technologies that run at different layers. While nobody would try to build a vehicle that is partly a compact sedan, partly an SUV and partly a motorcycle, there are situations in networking where you may want to do something surprisingly similar to this. Networking models help make this possible.



Key Concept: Networking models such as the OSI Reference Model provide a framework for breaking down complex internetworks into components that can more easily be understood and utilized. The model defines networking functions not as a large, complicated whole, but as a set of layered, modular components, each of which is responsible for a particular function. The result is better comprehension of network operations, improved performance and functionality, easier design and development, and the ability to combine different components in the way best suited to the needs of the network.

Why Understanding The OSI Reference Model Is Important To You

A lot of networking books and other resources gloss over the OSI Reference Model, including only passing mention of it, or relegating it to an appendix. The usual stated reason for this is that the OSI model is “too theoretical” and “doesn't apply to modern networking protocols like TCP/IP”.

I believe that this is a misguided notion. While it is certainly true the OSI model is primarily theoretical, and that networking protocols aren't always designed to fit strictly within the confines of its layers, it's *not* true that the OSI model has little applicability to the “real

world”. In fact, it is difficult to read about networking technology today without seeing references to the OSI model and its layers, because the model’s structure helps to frame discussions of protocols and contrast various technologies.

As just a few examples: the OSI Reference Model provides the basis for understanding how technologies like Ethernet and HomePNA have some important similarities; it explains how a PC can communicate using any of several different sets of protocols, even simultaneously; it is an important part of understanding the differences between interconnection devices such as repeaters, hubs, bridges, switches and routers; and it also explains how many WAN technologies interoperate.

Far from being obsolete, the OSI model layers are now showing up more than ever in discussions of technology. In fact, some protocols are even *named* specifically in terms of their place in the OSI Reference Model! For an example, consider the Layer Two Tunneling Protocol. Also, switches are now commonly categorized as being layer 2, layer 3 or even higher-layer switches.

In theoretical discussions, the OSI Reference Model helps you understand how networks and network protocols function. In the “real world”, it also helps you figure out which protocols and devices can interact with each other. So, I encourage you to read on. It’s time well spent.



Key Concept: While many people scoff at the notion of studying the OSI Reference Model, understanding it is very helpful in making sense of networking protocols and technologies. The model is theoretical, but its concepts are employed regularly to describe the operation of real-world networks.

How To Use The OSI Reference Model

I have been trying to make the point in this section that the OSI Reference Model is a very important tool in understanding how networks function. However, while some people tend to play down the OSI model too much, suggesting that it really isn’t very relevant today, there are others who go to the other extreme. They use it too much, overanalyzing and trying to use the model in a way that was never intended.

The most common mistake is attempting to try to “make everything fit” into the layered structure of the OSI model. (I must confess to falling into this trap myself on occasion.) When I first started laying out the [structure of this Guide](#), I wanted to organize *everything* based on where it fell in terms of OSI model layers. I quickly discovered that this was like attempting to put pegs of various shapes into a board containing only round holes. I had to change my approach. I ended up organizing the Guide based on the OSI layers where it made sense, and using a different structure where it did not.

I recommend that you learn from my experience. A simple rule of thumb is this: refer the OSI Reference Model if it helps you make sense of technologies and understand how they work; **don't** use it if it makes things more complicated instead of more clear. In particular, bear the following in mind:

- ☹ It can be very hard to even figure out where some technologies fall within the model. Many protocols were designed without the OSI model in mind, and they may not fall neatly into one layer or another. Some overlap two or more layers; other protocol suites may have two protocols that share a layer.
- ☹ The boundaries between the upper layers (session, presentation and application) get particularly fuzzy. Some protocols are clearly designed to fit at one of these layers, while others may overlap all three. It is for this reason that [I do not categorize higher-level protocols by layer in this Guide](#). (The OSI Reference Model was in fact designed to take into account the fact that differentiating between these layers might not make sense.)
- ☹ The OSI Reference Model was designed primarily with LANs in mind. WAN technologies often fit very poorly into the OSI model, with lots of overlapping and partial layer coverage. However, it's still useful in most cases to look at these protocols in terms of their approximate fit in the OSI model, since parts of WAN technologies are sometimes interchanged.
- ☹ The people who design products don't generally worry about ensuring that their latest inventions implement only specific layers of the model. Thus, sometimes new products come out that “break the rules” and implement functions across more than one layer that used to be done by multiple devices at the individual layers. This is usually progress, a good thing. 😊

Finally, an observation... I have noticed that people learning about networking—especially those trying to memorize easy answers to difficult questions so they can pass exams—often ask “at what layer does this piece of hardware operate?” The problem here is not the answer but rather the question, which is simplistic. With the exception of simple physical devices such as connectors and cables, pretty much **all** networking devices operate at many layers. While a router, for example, is usually associated with layer three; it has two or more device interfaces that implement layers two and one. A better question is what is the **highest** layer at which a device functions.

The bottom line is that the OSI Reference Model is a tool. If you use it wisely, it can be immensely helpful to you. Just remember not to be too inflexible in how you apply it, and you'll be fine.



Key Concept: It is just as much a mistake to assign too much importance to the OSI Reference Model as too little. While the model defines a framework for understanding networks, not all networking components, protocols and technologies will necessarily fall into the model's strict layering architecture. There are cases where trying to use the model to describe certain concepts can lead to less clarity rather than more. One should remember that the OSI model is a *tool*, and should be used accordingly.

Comparing the OSI Reference Model to Network Architectures and Protocol Stacks

The OSI Reference Model is not the only model used to describe the structure of networks. There are several other models and systems that are used to describe various sets of networking technologies that work together. These are generally not theoretical models, but rather describe groupings of protocols that are actively used in actual networks. They are, therefore, more often called *networking architectures* and *protocol suites* than models.

As I mentioned in [the previous topic](#), many technologies and protocols don't "fit" well into the specific layers used in the OSI model. Similarly, most of the protocol suites used in the "real world" don't fit the OSI model exactly. This happens, of course, because they were developed independently of the OSI model. Still, most of these architectures and suites still use layers—they are just different ones than the OSI model uses.

Since the OSI model is so often referenced, it can be very helpful in making sense of other architectures, and even comparing them. Regardless of what the individual layers and technologies are called, networking protocol suites all try to accomplish the same goals in implementing a network. Thus, even though the layers are not the same, they are often comparable.

In the case of TCP/IP, a [special model called the DOD model or TCP/IP model](#) is usually used in discussions of the suite. This model has many similarities to the OSI model, but also some important differences. In other areas in the field of networking, still other models are used, such as the IEEE 802 networking architecture model. These too are similar in some ways to the OSI model but have their own unique characteristics.

Even within the scope of some individual specific technologies, a layered structure of related protocols can be seen. There are technologies that are generally considered to implement a single level of the OSI model that actually have portions that overlap several layers; examples include Ethernet and ATM. In fact, some protocols even have **subprotocols** that are layered within the confines of what is considered a single layer under OSI; a good example is the [TCP/IP Point-to-Point Protocol \(PPP\)](#), which, despite the name, is not a single protocol but a protocol suite unto itself.



Key OSI Reference Model Concepts

The OSI Reference Model is valuable as a tool for explaining how networks function, and for describing the relationships between different networking technologies and protocols. To accomplish this, the model relies on a number of important concepts and terms. To understand the model, then, I need to explain what these are and how they relate to the model as a whole.

In this section, I describe the key concepts that define how the OSI Reference Model works. I begin with a discussion of how the model uses layers, perhaps the single most important model concepts. I then talk about some of the notation and jargon you are likely to see used in general discussions of the model. I define in more detail what “interfaces” and “protocols” are in the context of the model. I then explain the important concept of data encapsulation and the terminology used to refer to messages in the OSI Reference Model: PDUs and SDUs. Finally, I put together most of the preceding issues by describing how the various layers work to handle the routing of messages on a theoretical basis.



Note: Many of the concepts discussed in this section are also used by many people in describing the details of various individual technologies. The best example is the word “protocol”, which is used [just about everywhere](#) to refer to just about anything. My focus here is on the conceptual definitions of such terms. However, the conceptual discussions here often also apply to real-world technologies. For example, data encapsulation is performed as data is sent between protocols and technologies at various OSI layers, pretty much as I describe it here.

OSI Reference Model Networking Layers, Sublayers and Layer Groupings

The most important OSI Reference Model concept is that of networking *layers*. It’s not an exaggeration to say that layers are really the heart of the OSI model—the entire point of the model is to separate networking into distinct functions that operate at different levels. Each layer is responsible for performing a specific task or set of tasks, and dealing with the layers above and below it. The rest of this section will deal with many of the different nuances of this layer orientation.

OSI Reference Model Layers

The OSI Reference Model is comprised of seven conceptual layers, each assigned a “ranking” number from one to seven. The layer number represents the position of the layer in the model as a whole, and indicates how “close” the layer is to the actual hardware used to implement a network. The first and lowest layer is the *physical layer*, which is where low-

level signaling and hardware are implemented. The seventh and highest layer is the *application layer*, which deals with high-level applications employed by users: both end users and the operating system software.

You can see that as we proceed from the first layer to the seventh, we move up the *layer stack* and in so doing, increase our level of *abstraction*. This means that the higher a layer is in the stack, the more it deals with logical concepts and software, and the less it deals with the hardware of a network and the “nuts and bolts” of making it work.

The first layer is the most concrete, as it deals with the actual hardware of networks, and the specific methods of sending bits from one device to another. It is the domain of hardware engineers and signaling experts. The second layer is a bit more abstract but still deals with signaling and hardware. As you proceed through the third, fourth and subsequent layers, the technologies at those layers become increasingly abstract. By the time you reach the seventh layer, you are no longer dealing with hardware or even operating system concepts very much; you are in the realm of the user and high-level programs that rely on lower levels to do the “heavy lifting” for them.

OSI Reference Model Layer Groupings

The OSI Reference Model does not formally assign any relationship between groups of adjacent layers. However, to help explain how the layers work, it is common to categorize them into two *layer groupings*:

- ☉ **Lower Layers (Layers 1, 2, 3 and 4):** The lower layers of the model—*physical, data link, network* and *transport*—are primarily concerned with the formatting, encoding and transmission of data over the network. They don't care that much about what the data is or what it is being used for, just about moving it around. They are implemented in both hardware and software, with the transition from hardware to software occurring as you proceed up from layer 1 to layer 4.
- ☉ **Upper Layers (Layers 5, 6 and 7):** The higher layers of the model—*session, presentation* and *application*—are the ones that are concerned primarily with interacting with the user, and implementing the applications that run over the network. The protocols that run at higher layers are less concerned with the low-level details of how data gets sent from one place to another; they rely on the lower layers to provide delivery of data. These layers are almost always implemented as software running on a computer or other hardware device.

There are some who would not necessarily agree with how I have chosen to divide the layers above. In particular, valid arguments can be made for including the transport layer in the upper layer group, since it is usually implemented as software and is fairly abstract. I believe it is better as part of the lower layer group since its primary job is still providing services to higher layers for moving data, however. Really, layer 4 is somewhat of a “transition zone” and is hard to categorize. [Figure 11](#) shows how I divide the OSI Reference Model layers into groups and indicates the special position of layer 4 in the stack.

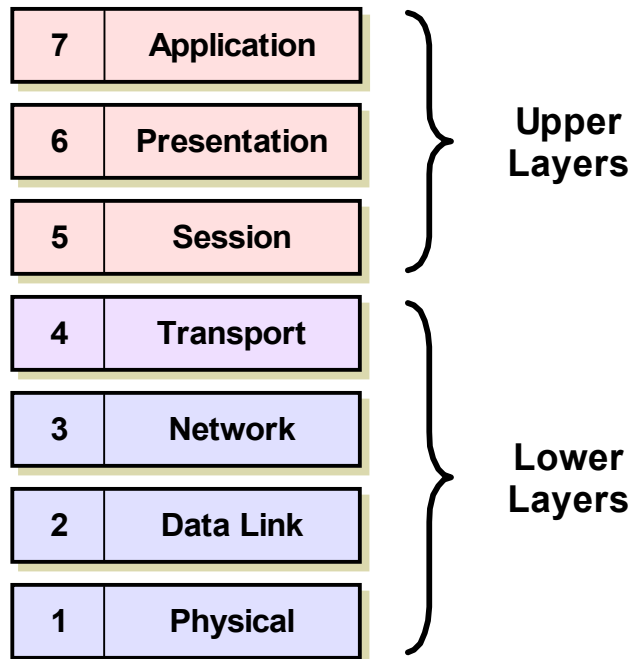

Figure 11: OSI Reference Model Layers

The OSI Reference Model divides networking functions into a stack of seven layers, numbered 1 through 7 from the bottom up. To help illustrate the differing levels of abstraction between layers near the top and those on the bottom, they are sometimes divided into two *layer groupings*—the *lower layers* and the *upper layers*. Of course, not everyone agrees on exactly how the division should be accomplished. In particular, the transport layer is sometimes considered an upper layer and sometimes a lower layer.



Key Concept: The most fundamental concept in the OSI Reference Model is the division of networking functions into a set of *layers*, from layer one at the bottom to layer seven at the top. As you go up the layer stack, you move away from concrete, hardware-specific functions to ones that are increasingly abstract, until reaching the realm of user applications at layer seven. The seven layers are sometimes divided into groupings: the lower layers (one, two and three) and the upper layers (four through seven). There is some disagreement on whether layer four is a lower or upper layer.

Relationships Between OSI Reference Model Layers

There are also certain OSI layers that have “natural” relationships to each other. The physical and data link layers, in particular, are closely related. For example, most people talk about Ethernet as being a “layer two technology”, but Ethernet specifications really deal with both layer 2 and layer 1. Similarly, layers three and four are often related; protocol suites are often designed so that layer three and four protocols work together; examples being TCP and IP in the [TCP/IP protocol suite](#) and IPX and SPX in the Novell suite.

In some areas, the layers are so closely related that the lines between them become *blurry*. This is particularly the case when looking at the higher layers; many technologies implement two or even all three of these layers, which is another reason why I feel they best belong in a group together. One important reason why the distinctions between layers five through seven are blurry is that the TCP/IP protocols are based on the [TCP/IP model](#), which combines the functions of layers five through seven in a single, thick layer.



Key Concept: The four lower layers of the OSI model are most often discussed individually, because the boundaries between them are reasonably clear-cut. In contrast, the lines between the session, presentation and application layers are somewhat blurry. As a result, sometimes protocols span two or even all three of these layers; this is especially true of TCP/IP application protocols, since the TCP/IP model treats layers five through seven as a single layer.

Sublayers

Finally, note that some OSI Reference Model layers are further divided into *sublayers* to help define more precisely the internal details of protocols and technologies at those layers. This is commonly done at the lower layers, especially the physical layer and the data link layer.

"N" Notation and Other OSI Model Layer Terminology

As a theoretical model, the OSI Reference Model comes complete with a set of terminology that is used to describe it and its constituent parts. This is sort of both good news and bad. The good news is that if you understand this terminology, it can help you comprehend much better most OSI model discussions, and also how technologies relate to the model. The bad news is that the terminology can also increase confusion—especially since it isn't always used consistently.

Common OSI Model Terminology Concepts

Let's discuss a few of the terminology concepts you will often see used to refer to the OSI Reference Model. Many of these are illustrated in [Figure 12](#).

Layer Names and Numbers

The various layers of the OSI Reference Model are referred to in a variety of ways. They may have their names spelled out in full, or they may be abbreviated. They are also often simply referenced by their layer number. So for example, all of these refer to the same thing: "data link layer", "Data Link Layer", "DLL", "L2", "layer two", "layer 2".

Similarly, you will often see layer names being used as adjectives to describe protocols and technologies. A "layer 3 technology" is one that operates primarily at the network layer.

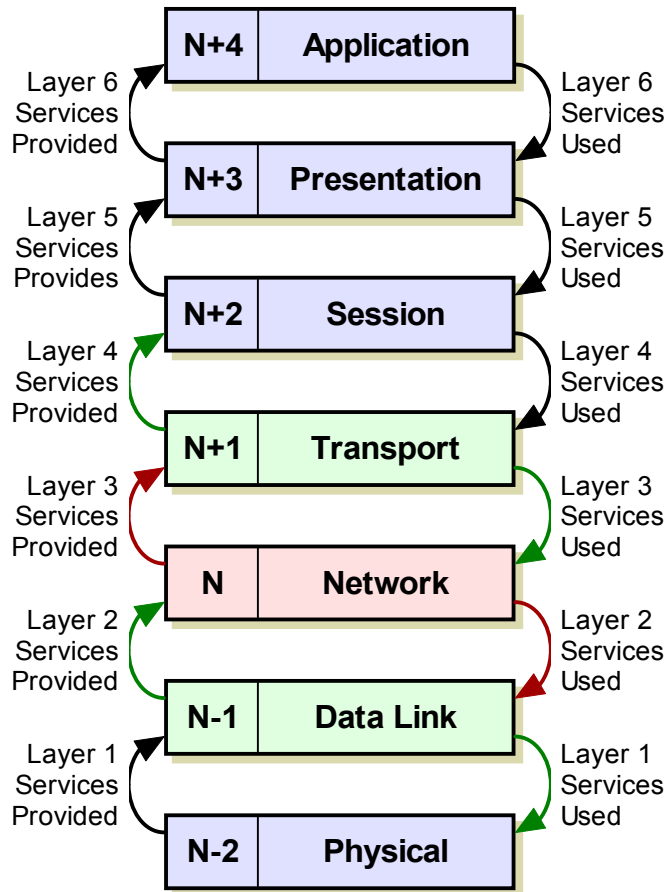

Figure 12: OSI Reference Model Layer Relationships and Terminology

This diagram shows the relationships between OSI model layers and the terminology used to refer to adjacent layers in the context of any particular layer. Each layer (except layer 7) provides services the layer above it; each layer (other than layer 1) uses services provided by the layer below. Another way of saying this is that each layer “N” provides services to layer “N+1” and uses the services of layer “N-1”. Taking the example of layer three, the network layer, we see that it provides services to layer four, and uses services of layer two. From the standpoint of the network layer, the transport layer is layer “N+1” and the data link layer “N-1”.

“N” Notation

The letter “N” is often used to generically refer to a number within the computer world. With respect to the OSI Reference Model, it’s common to see this letter used in discussions that relate generically to individual layers without mentioning a specific layer. You will hear terms like “N-functions” and “N-services”, which just refer to the functions and services provided within a particular layer.

As another example, you might see someone say that a particular technology “provides a useful service to the N+1 layer”. This just means it provides a function to the layer above the one at which it operates. Conceptually, every layer but the first and seventh have an “N-1” layer and an “N+1” layer, and so on. If you are looking at the network layer (layer 3) then the “N+2 layer” is the session layer (layer 5). [See the discussion of model layer interfaces for more information.](#)

Protocols and Interfaces

These words have special meaning within the context of the OSI model: a *protocol* represents communication between logical or physical devices at the same layer of the model while an *interface* represents information moving between adjacent layers within the same device.

Thus, in “N” notation, protocols represent communication between layer N on one device and layer N on another device, while interfaces deal with communication between layer N and N+1 or Layer N and N-1 on the same device. The topics on [OSI protocols](#) and [OSI interfaces](#) describe these issues much better.

Network Stacks

What do you get when you take a bunch of layers and put them all one on top of each other? Well, you get a *stack*. This term is used to refer to either the entire set of layers in a model or suite of technologies, or a partial set. Since each layer has protocols associated with it, this is also sometimes called the *protocol stack*.

Entities, Functions, Facilities and Services

These often-interchanged, somewhat vague terms refer to specific tasks or jobs performed at various layers in the model. An *N-entity* is a term that refers to a specific operation or job done at “layer N”. A *function* is basically the same thing. *Facilities* and *services* are what a layer provides to the layers above it. This is often expressed in N-notation as well: the “N+1” layer often uses a set of “N services” or “N facilities” provided by the “N” layer.

Making Sense of OSI Terminology

You may have just read all of that and said to yourself “why do they bother making this so **complicated** anyway?” Well, I can’t really argue with you. Remember, I **did** say there was bad news here. Now that you know what all of this stuff is about, should you run into it you won’t be... uh... *too* badly confused. ☺

Fortunately, the use of the buzzwords above is somewhat limited. Most references are to specific layer names or numbers, and in particular, the “N-1” and “N+1” stuff is rarely used in discussions of real-world technologies. However, it can be very useful in explaining the model itself, so you will see some of these terms as you read the rest of this chapter on the OSI model.

Interfaces: Vertical (Adjacent Layer) Communication

[The seven layers of the OSI Reference Model](#) are used to split up the various functions that are required to implement a networking system. On any given device in a network, different software and hardware routines and devices may be functioning on any or all of these

layers simultaneously. Since in general, all of these are supposed to be working together to implement networking functions, there is a need for layers to communicate *vertically* between the layers within a particular host.

OSI Interfaces

In OSI Reference Model parlance, the mechanism for communication between adjacent layers in the model is called an *interface*. Of course, the term “interface” is also used widely in other contexts in the computer and networking worlds, since its generic meaning refers to connecting just about *anything* together. However, when someone talks about an interface between OSI model layers, that person typically refers to the process by which data is passed between layer N of the model and layer N-1 or layer N+1.

These relationships are demonstrated in [Figure 13](#). For example, the layer 2/3 interface is used by a layer two and layer three protocol to pass data and control information; the layer 3/4 interface connects layers 3 and 4 together.



Note: Remember that not all layers may be implemented in every system or protocol stack in the “real world”. So it's possible that a process that is technically running at layer 7 might communicate with one running at layer 5. However, I am talking about the theoretical model here.

Vertical Communication

Vertical communication is done up and down the protocol stack every time anything is sent across the network, and of course, whenever anything is received. This occurs because the higher levels are implemented as logical functions, in software; there is no actual physical connection. The higher layers package data and send it down to the lower layers for it to be sent across the network. At the very lowest level, the data is sent over the network. On the receiving end, the process is reversed, with the data traveling back up to the higher layers on the receiving device. [The next topic dealing with horizontal communication](#) explains more about this logical interaction between corresponding layers.

Modularity and Inter-Layer Interactions

One of the primary goals of the OSI Reference Model is to allow the interconnection of different implementations of various layers. Thus, the intention is to have somewhat autonomous individual layers that you can “mix and match”—to a point. The only way to make this work is to have well-defined ways that the layers connect together, and that brings us back to the matter of interfaces. Each layer must present a consistent, well-documented interface to the layers above it so that any upper layer implementation can use the lower layer properly.

I'll provide an example from the world of TCP/IP to illustrate what I mean. The heart of the TCP/IP protocol suite is the Internet Protocol (IP). Whenever you use any application on the Internet—email, Web sites, FTP, chat rooms, and so on—you are indirectly using IP.

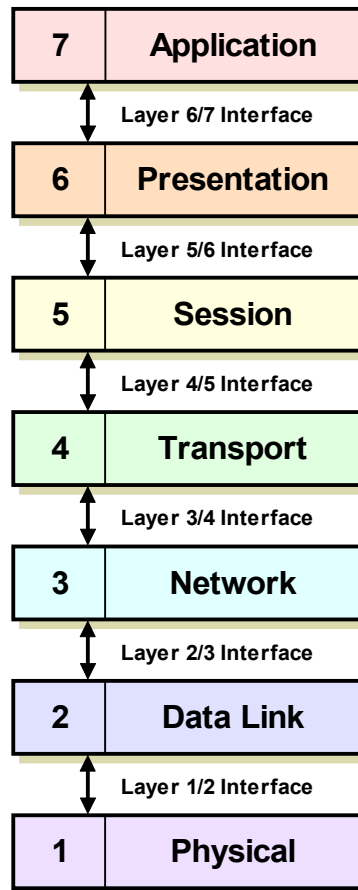

Figure 13: OSI Reference Model Interfaces for Vertical Communication

In OSI model terminology, an *interface* is a conduit for communication between adjacent layers in the layer stack.

However, you never use IP directly—you generally use one of two transport layer (layer 4) protocols: the [Transmission Control Protocol \(TCP\)](#) or the [User Datagram Protocol \(UDP\)](#). A standard interface exists between the network layer and the transport layer in the TCP/IP protocol stack, which defines how IP is to be used by upper layer protocols; this enables TCP and UDP to interface to it. Similarly, both TCP and UDP present a particular interface to the hundreds of higher-layer protocols and applications that use them at higher layers.

Many different types of communication actually take place between layers. Control information is passed to enable the higher layers to utilize the lower ones, and for the lower ones to pass status and results information back to the higher ones. Data is also passed in both directions across the interface. For transmission, it flows down to the lower layer, each time normally resulting in [data encapsulation](#). Upon reception, the process is reversed, with data being sent back up across the interface from lower to higher layer.



Key Concept: In the OSI Reference Model, an interface defines the mechanism for vertical communication between adjacent layers. The existence of well-defined interfaces between layers is what permits a higher layer to use the services of any of a number of lower layers, without requiring knowledge of how those layers are implemented.

Protocols: Horizontal (Corresponding Layer) Communication

Each layer in the OSI Reference Model has a particular role (or roles)—a set of general tasks for which it is responsible. On each system on the network, hardware and software are running at many of the different levels in the model. The routines doing a particular job on machine “A” are designed to communicate with similar or complementary ones that are running on machine “B”. This *horizontal communication* is the very heart of what networking is about. It is what enables Web browsers and Web servers to talk, email applications to exchange messages, and so much more.

OSI Protocols

Of course, all types of communication function only if everyone agrees to the same methods of accomplishing it. Each set of rules describing one type of communication is called a *protocol*. You can think of a protocol as being like a language or a set of instructions. Each function or service of a network has its own language; like human languages, some are similar to each other while others are quite unique.

If you've done any reading at all about networks, you have probably seen the term “protocol” many, many times. Like the word “interface”, the word “protocol” can have many meanings. In fact, it is so fundamental to networking, and used in so many different ways, that [I have a topic devoted to it](#) in the chapter on Networking Fundamentals.

All that aside, we must remember that the OSI Reference Model is intended to be a formal way of describing networks. As such, the term “protocol” has a formal meaning in the context of the model. It refers specifically to a set of communication rules, instructions and/or procedures that describe communication between specific software or hardware elements running *at the same layer* on different machines within a network.

Horizontal Communication

Let's consider how these corresponding layers communicate using protocols. First, recall that every layer in the model, except the bottom (physical) layer, is really a program or algorithm running on a computer. There is no way for, say, a Web browser and a Web server to actually connect together directly—they are just software programs, after all. Instead, the software running at various layers communicates **logically**. That is to say, through the use of software and procedures, a process running at layer 5 on one machine can accomplish *logical communication* with a similar process running at layer 5 on another machine.

Since machines are only physically connected at layer 1, this means that in order for a protocol at layer 5 to function, the data on the sending machine must “pass down” the data through the layers between layer 5 and layer 1. The data is then transmitted over the physical connection to layer 1 of the other machine, and “passed up” the protocol stack of the receiving machine to layer 5. This is how the two machines are logically linked at layer 5, even though they have no physical connection at that layer.

Thus, with the exception of the actual physical connection at layer 1, all horizontal communication also requires vertical communication—down the stack on one machine, and then back up the stack on the other. This process is illustrated in [Figure 14](#). (The communication doesn’t always go all the way back up the stack for each connection, however, as in the case of [routing](#).)



Key Concept: In the OSI Reference Model, a *protocol* refers specifically to a set of rules or procedures that define communication between software or hardware elements running at the same layer on network devices. Physical layer protocols are responsible for the actual transmission and reception of data at layer one. Protocols at higher layers pass data down through the layers below them to layer one for transmission, then across the network and back up to the corresponding entity at the same layer on the receiving device. The result is that software processes running at say, layer four on each of two devices can communicate *logically* as if they were directly connected at layer four, when they are not.

Data Encapsulation, Protocol Data Units (PDUs) and Service Data Units (SDUs)

Protocols are what describe the rules that control [horizontal communication](#), that is, conversations between processes that run at corresponding layers within the OSI Reference Model. At every layer (except layer one) these communications ultimately take the form of some sort of message that is sent between corresponding software elements on two or more devices. Since these messages are the mechanism for communicating information between protocols, they are most generally called *protocol data units (PDUs)*. Each PDU has a specific format that implements the features and requirements of the protocol.

Layer Services and Data Encapsulation

As we’ve already discussed in [our look at protocols](#), the communication between layers higher than layer one is *logical*; the only hardware connection is at the physical layer. Thus, in order for a protocol to communicate, it must pass down its PDU to the next lower layer for transmission. We’ve also already seen that [using OSI terminology](#), lower layers are said to provide *services* to the layers immediately above them. One of the services each layer provides is this function: to handle and manage data received from the layer above.

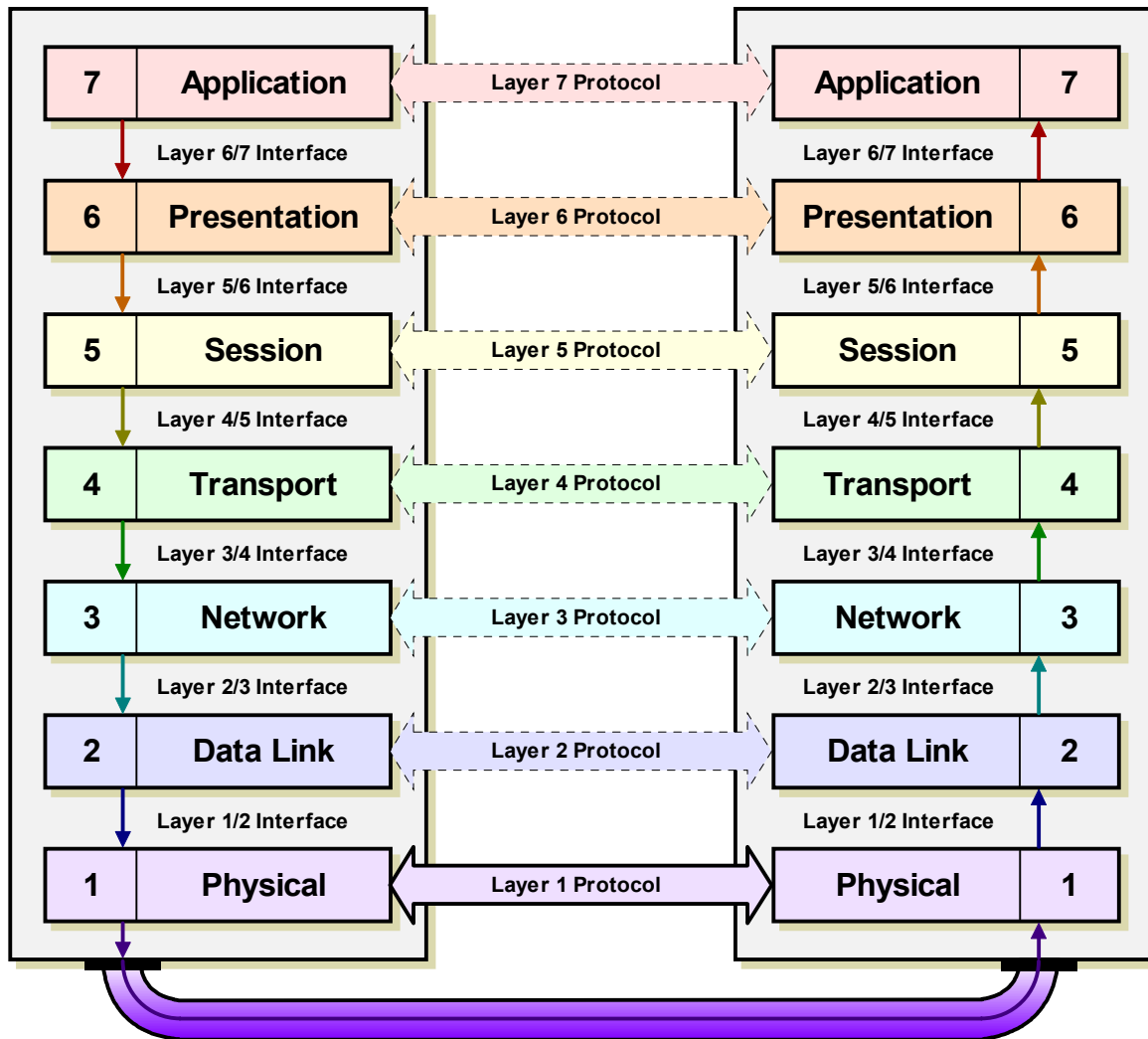

Figure 14: OSI Reference Model Protocols: Horizontal Communication

The term “protocol” has many meanings; in the context of the OSI Reference Model, it refers specifically to software or hardware elements that accomplish communication between corresponding layers on two or more devices. For example, the Internet Protocol is said to be a layer 3 protocol because each device uses IP software to communicate at layer 3. The actual transmission and reception of data only occurs at the lowest, physical layer; higher-layer protocols communicate *logically*, by passing data down interfaces until it reaches layer 1, transmitting at layer 1, and then passing the data back up to the appropriate layer at the recipient.

At any particular layer N, a PDU is a complete message that implements the protocol at that layer. However, when this “layer N PDU” is passed down to layer N-1, it becomes the **data** that the layer N-1 protocol is supposed to **service**. Thus, the layer N protocol data unit (PDU) is called the layer N-1 *service data unit (SDU)*. The job of layer N-1 is to transport this SDU, which it does in turn by placing the layer N SDU into its own PDU format, preceding the SDU with its own headers and appending footers as necessary. This process is called *data encapsulation*, because the entire contents of the higher-layer message are encapsulated as the data payload of the message at the lower layer.

What does layer N-1 do with its PDU? It of course passes it down to the next lower layer, where it is treated as a layer N-2 SDU. Layer N-2 creates a layer N-2 PDU containing the layer N-1 SDU and layer N-2's headers and footers. And the so the process continues, all the way down to the physical layer. In the theoretical model, what you end up with is a message at layer 1 that consists of application-layer data that is encapsulated with headers and/or footers from each of layers 7 through 2 in turn, as shown in [Figure 15](#).

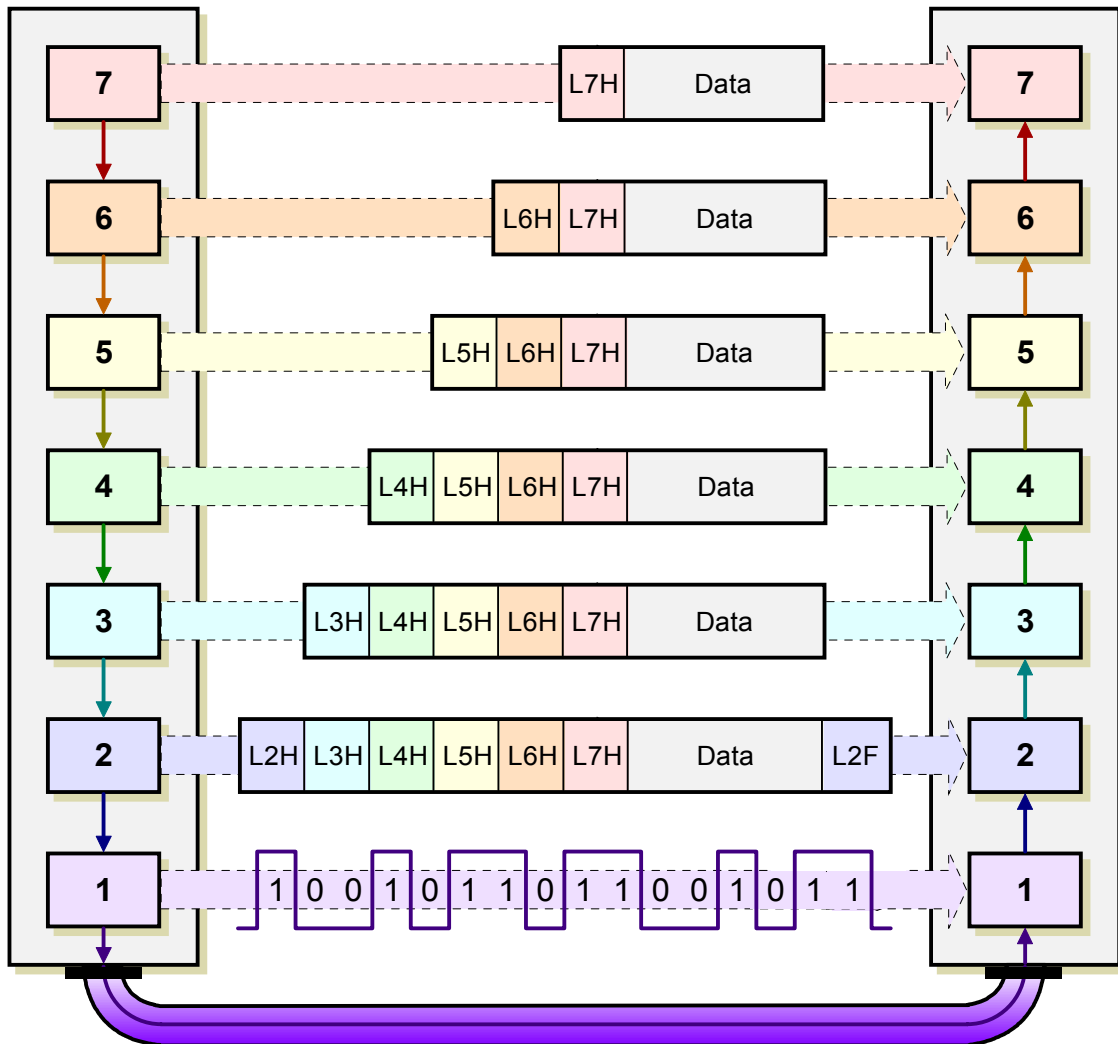

Figure 15: OSI Reference Model Data Encapsulation

Each protocol creates a *protocol data unit (PDU)* for transmission that includes headers required by that protocol and data to be transmitted. This data becomes the *service data unit (SDU)* of the next layer below it. This diagram shows a layer 7 PDU consisting of a layer 7 header (“L7H”) and application data. When this is passed to layer 6, it becomes a layer 6 SDU. The layer 6 protocol prepends to it a layer 6 header (“L6H”) to create a layer 6 PDU, which is passed to layer 5. The encapsulation process continues all the way down to layer 2, which creates a layer 2 PDU—in this case shown with both a header and a footer—that is converted to bits and sent at layer 1.

Data Encapsulation in TCP/IP

The “N-1, N-2” stuff makes this seem more difficult than it really is, so let’s use a real-world (simplified) example instead. The [Transmission Control Protocol \(TCP\)](#) operates at layer 4 of the OSI model. It transmits messages called *segments* that contain data encapsulated from higher-layer protocols. The layer below TCP is the [Internet Protocol \(IP\)](#) at layer 3. It receives data from TCP and encapsulates it for transmission.

So, in the formal language of the OSI Reference Model, TCP segments are created as layer 4 PDUs. When passed to IP, they are treated as layer 3 SDUs. The IP software packages these SDUs into messages called *IP packets* or *IP datagrams*, which are layer 3 PDUs. These are in turn passed down to a layer 2 protocol, say Ethernet, which treats IP datagrams as layer 2 SDUs, and packages them into layer 2 PDUs (Ethernet frames) which are sent on layer 1. (Actually, in some technologies further encapsulation even occurs at layer one prior to transmission.)

On the receiving device, the process of encapsulation is reversed. The Ethernet software inspects the layer 2 PDU (Ethernet frame) and removes from it the layer 2 SDU (IP datagram) which it passes up to IP as a layer 3 PDU. The IP layer removes the layer 3 SDU (TCP segment) and passes it to TCP as a layer 4 PDU. TCP in turn continues the process, going back up the protocol layer stack. The complete process is illustrated in [Figure 16](#).

This whole matter of passing data up and down the protocol stack, encapsulation and so on may seem needlessly complex. It also may appear to be rather inefficient; why send a message with so many headers and footer? However, the notion of data encapsulation is critical to creating modular, flexible networks.

Use of PDU and SDU Terminology

The term “protocol data unit” is rather formal. You will see it used in standards and sometimes in discussions, but more often, the “plain” message terms, such as “frame” and “datagram”, are encountered, as discussed in the [networking fundamentals topic on messages](#). Similarly, data encapsulated by these messages is not normally called a “service data unit” but rather simply the *message body* or *payload*, as discussed in [the topic on message formatting](#). There are cases, however, where knowing the difference between an SDU and a PDU is important to understanding the technology. One example is the IEEE 802.11 physical layer; the 802.11 standards talk about SDUs and PDUs constantly.



Related Information: See the [OSI Reference Model analogy](#) if you want to see an example that compares networking encapsulation to a type done in a real-world, non-networking context.

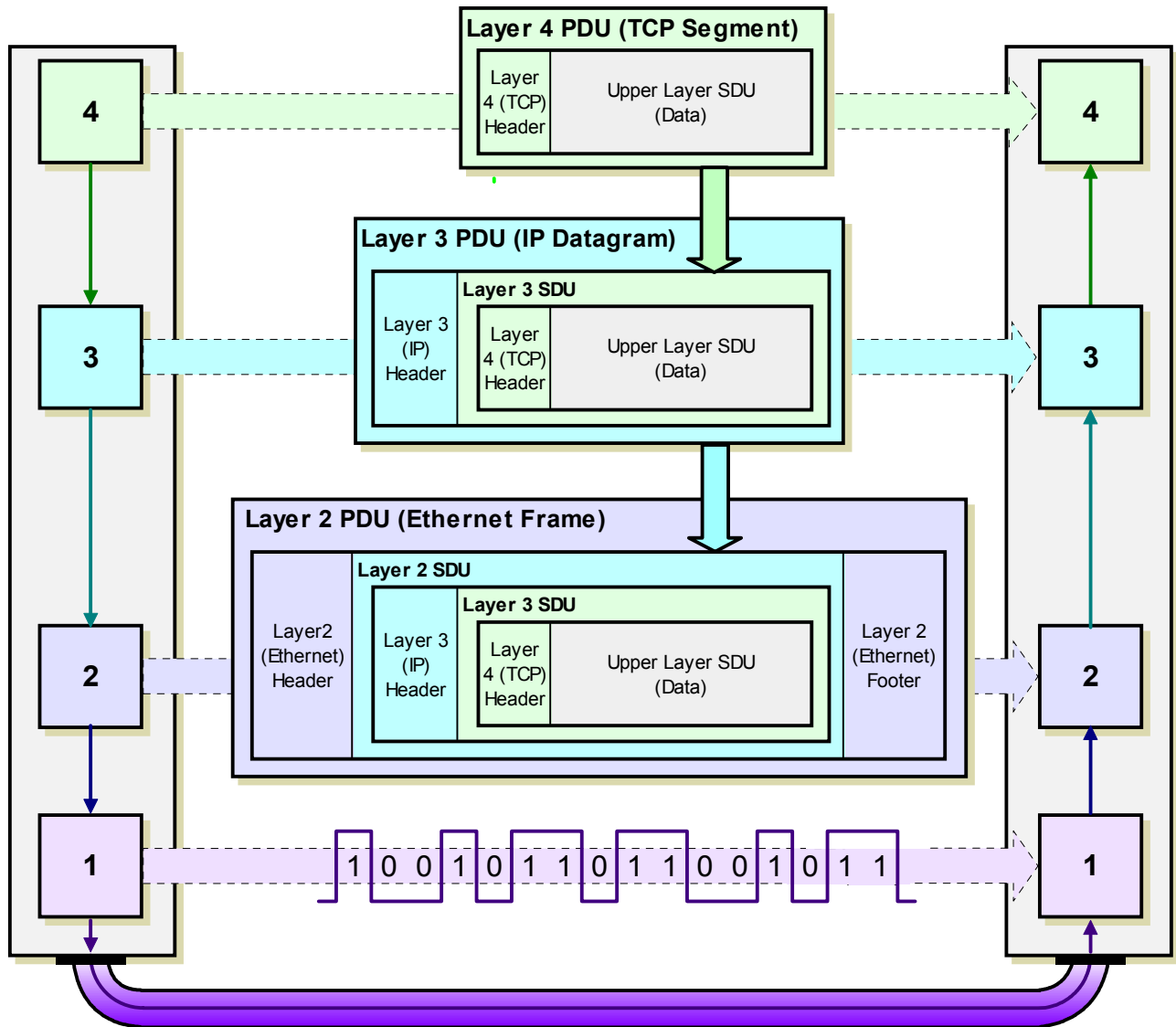

Figure 16: OSI Reference Model PDU and SDU Encapsulation

This example shows in more detail how OSI PDUs and SDUs are created and encapsulated. A TCP segment (layer 4 PDU) becomes a layer 3 SDU, which is encapsulated into a layer 3 PDU through the addition of an IP header. This becomes the payload of an Ethernet frame, which is a layer 2 PDU containing an Ethernet header, layer 2 SDU (the IP datagram) and Ethernet footer. The receiving device extracts the IP datagram from the Ethernet header and passes it to layer 3; the IP software extracts the TCP segment and passes it up to the TCP software.



Key Concept: The message used to communicate information for a particular protocol is called its *protocol data unit (PDU)* in OSI model terminology. That PDU is passed down to the next lower layer for transmission; since that layer is providing the service of handling that PDU, it is called the lower layer's *service data unit (SDU)*. The SDU is *encapsulated* into that layer's own PDU and in turn sent to the next lower layer in the stack, proceeding until the physical layer is reached. The process is reversed on the recipient device. In summary: a layer N PDU is a layer N-1 SDU, which is encapsulated into a layer N-1 PDU.

Indirect Device Connection and Message Routing

Most of the explanations that I have provided in the other topics of this section have discussed the mechanisms by which machines connect to each other over a network *directly*. However, one of the most powerful aspects of networking is that it is possible to create internetworks—networks of networks—which allow devices to be connected *indirectly*. For example, machine “A” may send a message to machine “B” without really even knowing where it is on the network at all.

If a message is being sent between devices that are not on the same network, then it must be passed between directly-connected networks until it reaches its final destination. The process of transmitting a message from one network to another is called *forwarding*, and the collective process of forwarding from one device to another is *routing*. These concepts are fundamental to all internetworking, including the Internet itself. Every time you access an Internet resource such as a Web site, you are sending messages that get routed to that site, and the responses you receive get routed back.



Note: Even though the technically-correct term for moving a message from one network to an adjacent network is “forwarding”, over time the term “routing” has come to often be used both for a single network-to-network transfer as well as the overall process of transmitting a message from one device to another.

In the context of the OSI Reference Model, routing is an activity that generally takes place at the network layer—layer 3. Recall that [data encapsulation](#) causes a higher-layer message to be surrounded by headers and/or footers at the lower layers. When a message is routed, here's what happens:

- A high-level application on a machine decides to send a datagram to a distant computer. The datagram is packaged, and then [passed down vertically](#) through the protocol stack on the originating machine. Each layer encapsulates the data as described earlier. The datagram is addressed to the final destination device. When the message gets to the network layer and below, however, it is not packaged for local

delivery directly to its ultimate destination, but rather to an *intermediate device*. This is the device that is responsible for routing to that destination network. The message is passed down to the data link layer and then the physical layer for transmission to that intermediate device.

- ☉ The intermediate device (often called a *router*) receives the message at the physical layer. It is passed up to the data link layer, where it is processed, checked for errors and so on, and the data link layer headers are removed. The resulting packet is passed up to the network layer. There, the intermediate device determines if the destination machine is on its local network, or if it needs to be forwarded to another intermediate device. It then repackages the message and passes it back *down* to the data link layer to be sent on the next leg of its journey.
- ☉ After several potential intermediate devices “handle” the message, it eventually reaches its destination. Here, it travels back up the protocol stack until it reaches the same layer as the one of the application that generated the message on the originating machine.

The key to this description is that in the intermediate devices, the message travels back up the OSI layers *only to the network layer*. It is then repackaged and sent back along its way. The higher layers are only involved on the source and destination devices. The protocol used at layer 3 must be common across the internetwork but each individual network can be different. This demonstrates some of the power of layering, by enabling even rather dissimilar physical networks to be connected together. The process is illustrated in [Figure 17](#).



Key Concept: In the OSI model, the process of *routing* occurs when data is sent not directly from transmitter to ultimate recipient, but indirectly through the use of an intermediate system. That device, normally called a *router*, connects to two or more physical networks and thus has multiple interfaces to layer two. When it receives data, the data passes up only to the network layer, where it is repackaged and then sent on the next leg of its journey over the appropriate layer two interface.



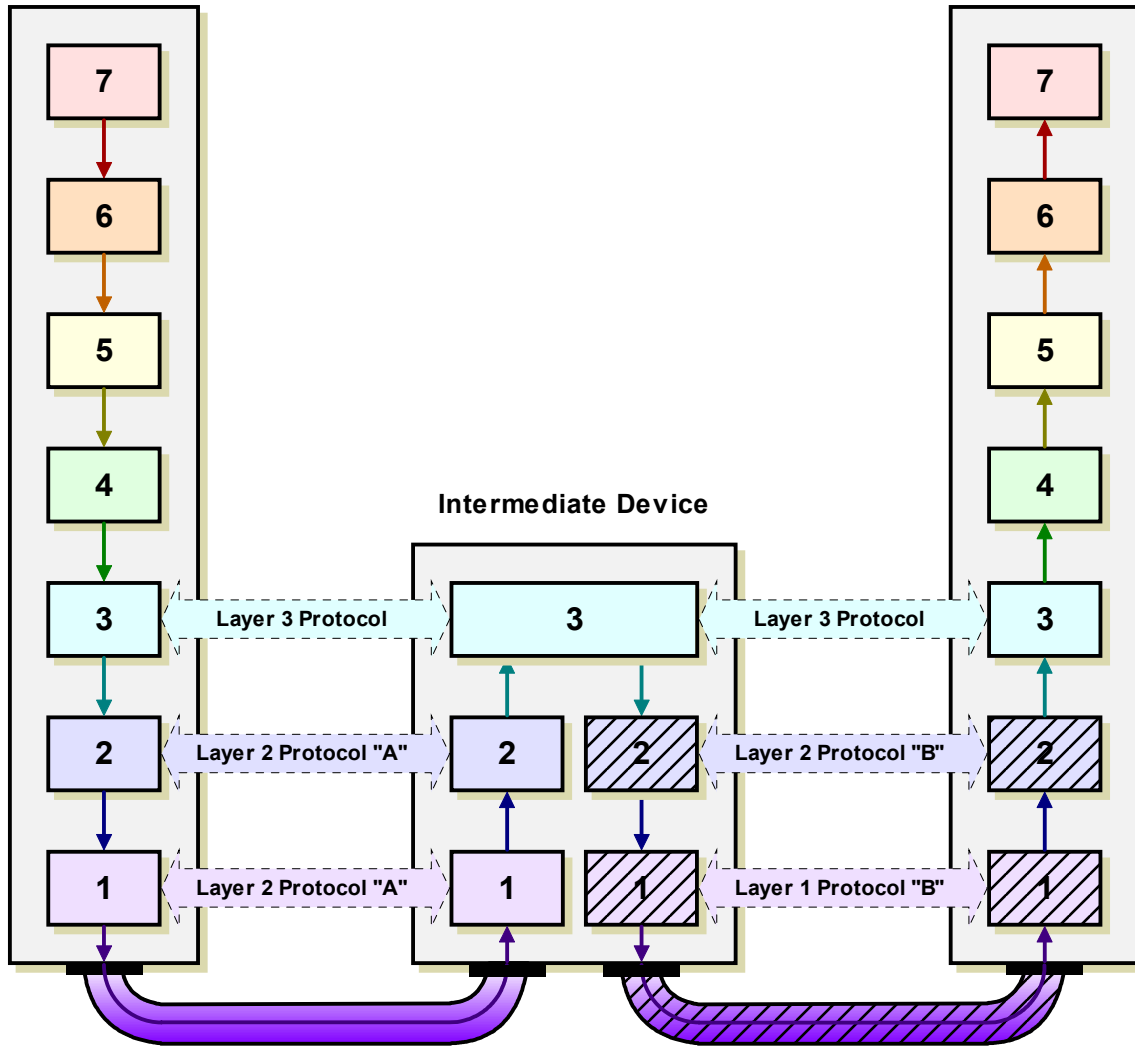

Figure 17: Message Routing in the OSI Reference Model

This diagram shows how routing is accomplished conceptually in the OSI model. The intermediate device connects the networks of the message transmitter and recipient. When data is sent, it is passed up to the network layer on the intermediate device, where it is repackaged and sent back down the stack for the next leg of its transmission. Note that the intermediate device actually has two different layer 1 and 2 implementations; one for the interface to each network. Also note that while the layer 3 protocol must be the same across the internetwork, each network can use different technologies at layers 1 and 2.

Understanding The OSI Reference Model: An Analogy

I have attempted in this discussion of the OSI Reference Model to provide as much “plain English” explanation of how it works as I could. However, there are situations where a good analogy can accomplish what lots of descriptions cannot. So, I am going to attempt to illustrate the key OSI model concepts ([layers](#), [vertical communication](#), [horizontal communication](#), [data encapsulation](#) and [message routing](#)) by way of a real-life analogy. You can be the judge of whether it is a **good** analogy or not. Just remember that no analogy is perfect.

Our scenario seems relatively simple and common: the CEO of a Fortune 500 company needs to send a letter to the CEO of another large company. Simple, right? Just like firing up your browser and connecting to your favorite Web site is simple. However, in both cases, a lot goes on “behind the scenes” to make the communication happen. In the analogy shown in [Table 18](#) below, I compare these real-world and “cyber-world” communications.



Note: (Yes, the first CEO *could* fly to the other one's town in his Lear Jet, take him out for a lobster-and-martini dinner and hand him the letter there. Please play along, will you? Oh, and sorry to any CEOs for the blatant stereotyping. ☺)

Table 18: OSI Reference Model Real-World Analogy (Page 1 of 3)

Phase	OSI Layer	CEO Letter	Web Site Connection (Simplified)
Transmission	7	The CEO of a company in Phoenix decides he needs to send a letter to a peer of his in Albany. He dictates the letter to his administrative assistant.	You decide you want to connect to the web server at IP address 10.0.12.34, which is within your organization but not on your local network. You type the address into your browser.
	6	The administrative assistant transcribes the dictation into writing.	(Generally, with a web site connection, nothing happens at this layer, but format translation may be done in some cases.)
	5	The administrative assistant puts the letter in an envelope and gives it to the mail room. The assistant doesn't actually know how the letter will be sent, but he knows it is urgent so he says, “get this to its destination quickly”.	The request is sent via a call to an application program interface (API), to issue the command necessary to contact the server at that address.
	4	The mail room must decide how to get the letter where it needs to go. Since it is a rush, the people in the mail room decide they must use a courier. The envelope is given to the courier company to send.	The Transmission Control Protocol (TCP) is used to create a segment to be sent to IP address 10.0.12.34.

Table 18: OSI Reference Model Real-World Analogy (Page 2 of 3)

Phase	OSI Layer	CEO Letter	Web Site Connection (Simplified)
Routing	3	The courier company receives the envelope, but it needs to add its own handling information, so it places the smaller envelope in a courier envelope (encapsulation). The courier then consults its airplane route information and determines that to get this envelope to Albany, it must be flown through its hub in Chicago. It hands this envelope to the workers who load packages on airplanes.	Your computer creates an IP datagram encapsulating the TCP datagram created above. It then addresses the packet to 10.0.12.34. but discovers that it is not on its local network. So instead, it realizes it needs to send the message to its designated routing device at IP address 10.0.43.21. It hands the packet to the driver for your Ethernet card (the software that interfaces to the Ethernet hardware).
	2	The workers take the courier envelope and put on it a tag with the code for Chicago. They then put it in a handling box and then load it on the plane to Chicago.	The Ethernet card driver forms a frame containing the IP datagram and prepares it to be sent over the network. It packages the message and puts the address 10.0.43.21 (for the router) in the frame.
	1	The plane flies to Chicago.	The frame is sent over the twisted pair cable that connects your local area network. (I'm ignoring overhead, collisions, etc. here, but then I also ignored the possibility of collisions with the plane. ☺)
	2	In Chicago, the box is unloaded, and the courier envelope is removed from it and given to the people who handle routing in Chicago.	The Ethernet card at the machine with IP address 10.0.43.21 receives the frame, strips off the frame headers and hands it up to the network layer.
	3	The tag marked "Chicago" is removed from the outside of the courier envelope. The envelope is then given back to the airplane workers to be sent to Albany.	The IP datagram is processed by the router, which realizes the destination (10.0.12.34) can be reached directly. It passes the datagram back down to the Ethernet driver.
	2	The envelope is given a new tag with the code for Albany, placed in another box and loaded on the plane to Albany.	The Ethernet driver creates a new frame and prepares to send it to the device that uses IP address 10.0.12.34.
	1	The plane flies to Albany.	The frame is sent over the network.
	2	The box is unloaded and the courier envelope is removed from the box. It is given to the Albany routing office.	The Ethernet card at the device with IP address 10.0.12.34 receives the frame, strips off the headers and passes it up the stack.

Table 18: OSI Reference Model Real-World Analogy (Page 3 of 3)

Phase	OSI Layer	CEO Letter	Web Site Connection (Simplified)
Reception	3	The courier company in Albany sees that the destination is in Albany, and delivers the envelope to the destination CEO's company.	The IP headers are removed from the datagram and the TCP segment handed up to TCP.
	4	The mail room removes the inner envelope from the courier envelope and delivers it to the destination CEO's assistant.	TCP removes its headers and hands the data up to the drivers on the destination machine.
	5	The assistant takes the letter out of the envelope.	The request is sent to the Web server software for processing.
	6	The assistant reads the letter and decides whether to give the letter to the CEO, transcribe it to email, call the CEO on her cell phone, or whatever.	(Again, in this example nothing probably happens at the Presentation layer.)
	7	The second CEO receives the message that was sent by the first one.	The Web server receives and processes the request.

As you can see, the processes have a fair bit in common. The vertical communication and encapsulation are pretty obvious, as is the routing. Also implied is the horizontal communication that occurs logically—the two CEOs seem to be “connected” despite all that happens to enable this to occur. Similarly, the two assistants are logically connected as well, in a way, even though they never actually converse. Of course, this example is highly simplified in just about every way imaginable, so please don’t use it as a way of trying to learn about how TCP/IP works—or courier services, for that matter.

Anyway, I hope the example helps make some sense of all of this OSI stuff!



OSI Reference Model Layers

Finally, after much ado—hopefully not **too** much!—it is time to take a look at the actual individual layers of the OSI Reference Model. As discussed in [the section on OSI model concepts](#), each layer has certain characteristics that define it, and also various protocols normally associated with it. Understanding the nuances of each layer will help you understand all the technologies that use them.

In this section, I describe each of the OSI Reference Model layers individually. For each one I provide its name and layer number, describe its general function in the OSI layer stack, and outline the specific types of activities for which each is normally responsible. I also provide some examples of the technologies and protocols that reside at each layer. Keep in mind, however, that the descriptions in this section are *generic*. To really comprehend the various layers and how they are used, there is no substitute for reading the details of the individual protocols that function at each layer, covered elsewhere in this Guide.



Related Information: For assistance in remembering the correct order of the layers, see [the topic that describes common mnemonics used for the OSI Reference Model](#). To easily compare the key characteristics of the seven layers, refer to the [OSI model layer summary](#).

Physical Layer (Layer 1)

The lowest layer of the OSI Reference Model is layer 1, the *physical layer*; it is commonly abbreviated “PHY”. The physical layer is special compared to the other layers of the model, because it is the only one where data is physically moved across the network interface. All of the other layers perform useful functions to create messages to be sent, but they must all be transmitted down the protocol stack to the physical layer, where they are actually sent out over the network.



Note: The physical layer is also “special” in that it is the only layer that really does not apply specifically to TCP/IP. Even in studying TCP/IP, however, it is still important to understand its significance and role in relation to the other layers where TCP/IP protocols reside.

Understanding the Role of the Physical Layer

The name “physical layer” can be a bit problematic. Because of that name, and because of what I just said about the physical layer actually transmitting data, many people who study networking get the impression that the physical layer is only about actual network hardware.

Some people may say the physical layer is “the network interface cards and cables”. This is not actually the case, however. The physical layer defines a number of network functions, not just hardware cables and cards.

A related notion is that “all network hardware belongs to the physical layer”. Again, this isn't strictly accurate. All hardware must have **some** relation to the physical layer in order to send data over the network, but hardware devices generally implement multiple layers of the OSI model, including the physical layer but also others. For example, an Ethernet network interface card performs functions at both the physical layer and the data link layer.

Physical Layer Functions

The following are the main responsibilities of the physical layer in the OSI Reference Model:

- ④ **Definition of Hardware Specifications:** The details of operation of cables, connectors, wireless radio transceivers, network interface cards and other hardware devices are generally a function of the physical layer (although also partially the data link layer; see below).
- ④ **Encoding and Signaling:** The physical layer is responsible for various encoding and signaling functions that transform the data from bits that reside within a computer or other device into signals that can be sent over the network.
- ④ **Data Transmission and Reception:** After encoding the data appropriately, the physical layer actually transmits the data, and of course, receives it. Note that this applies equally to wired and wireless networks, even if there is no tangible cable in a wireless network!
- ④ **Topology and Physical Network Design:** The physical layer is also considered the domain of many hardware-related network design issues, such as LAN and WAN topology.

In general, then, physical layer technologies are ones that are at the very lowest level and deal with the actual ones and zeroes that are sent over the network. For example, when considering network interconnection devices, the simplest ones operate at the physical layer: repeaters, conventional hubs and transceivers. These devices have absolutely no knowledge of the contents of a message. They just take input bits and send them as output. Devices like switches and routers operate at higher layers and look at the data they receive as being more than voltage or light pulses that represent one or zero.

Relationship Between the Physical Layer and Data Link Layer

It's important to point out that while the physical layer of a network technology primarily defines the hardware it uses, the physical layer is closely related to the data link layer. Thus, it is not generally possible to define hardware at the physical layer “independently” of the technology being used at the data link layer. For example, Ethernet is a technology that describes specific types of cables and network hardware, but the physical layer of Ethernet can only be isolated from its data link layer aspects to a point. While Ethernet cables are “physical layer”, for example, their maximum length is related closely to message format rules that exist at the data link layer.

Furthermore, some technologies perform functions at the physical layer that are normally more closely associated with the data link layer. For example, it is common to have the physical layer perform low-level (bit level) repackaging of data link layer frames for transmission. Error detection and correction may also be done at layer 1 in some cases. Most people would consider these “layer two functions”.

In many technologies, a number of physical layers can be used with a data link layer. Again here, the classic example is Ethernet, where dozens of different physical layer implementations exist, each of which uses the same data link layer (possibly with slight variations.)

Physical Layer Sublayers

Finally, many technologies further subdivide the physical layer into *sublayers*. In order to increase performance, physical layer encoding and transmission methods have become more complex over time. The physical layer may be broken into layers to allow different network media to be supported by the same technology, while sharing other functions at the physical layer that are common between the various media. A good example of this is the physical layer architecture used for Fast Ethernet, Gigabit Ethernet and 10-Gigabit Ethernet.



Note: In some contexts, the physical layer technology used to convey bits across a network or communications line is called a *transport method*. Don't confuse this with the functions of the [OSI transport layer \(layer 4\)](#).



Key Concept: The lowest layer in the OSI Reference Model is the *physical layer*. It is the realm of networking hardware specifications, and is the place where technologies reside that perform data encoding, signaling, transmission and reception functions. The physical layer is closely related to the data link layer.

Data Link Layer (Layer 2)

The second-lowest layer (layer 2) in the OSI Reference Model stack is the *data link layer*, often abbreviated “DLL” (though that abbreviation has other meanings as well in the computer world). The data link layer, also sometimes just called the *link layer*, is where many wired and wireless local area networking (LAN) technologies primarily function. For example, Ethernet, Token Ring, FDDI and 802.11 (“wireless Ethernet” or “Wi-Fi”) are all sometimes called “data link layer technologies”. The set of devices connected at the data link layer is what is commonly considered a simple “[network](#)”, as opposed to an [internetwork](#).

Data Link Layer Sublayers: Logical Link Control (LLC) and Media Access Control (MAC)

The data link layer is often conceptually divided into two sublayers: *logical link control (LLC)* and *media access control (MAC)*. This split is based on the architecture used in the IEEE 802 Project, which is the IEEE working group responsible for creating the standards that define many networking technologies (including all of the ones I mentioned above except FDDI). By separating LLC and MAC functions, interoperability of different network technologies is made easier, as explained in our earlier discussion of networking model concepts.

Data Link Layer Functions

The following are the key tasks performed at the data link layer:

- ① **Logical Link Control (LLC):** Logical link control refers to the functions required for the establishment and control of logical links between local devices on a network. As mentioned above, this is usually considered a DLL sublayer; it provides services to the network layer above it and hides the rest of the details of the data link layer to allow different technologies to work seamlessly with the higher layers. Most local area networking technologies use the IEEE 802.2 LLC protocol.
- ② **Media Access Control (MAC):** This refers to the procedures used by devices to control access to the network medium. Since many networks use a shared medium (such as a single network cable, or a series of cables that are electrically connected into a single virtual medium) it is necessary to have rules for managing the medium to avoid conflicts. For example, Ethernet uses the CSMA/CD method of media access control, while Token Ring uses token passing.
- ③ **Data Framing:** The data link layer is responsible for the final encapsulation of higher-level messages into *frames* that are sent over the network at the physical layer.
- ④ **Addressing:** The data link layer is the lowest layer in the OSI model that is concerned with addressing: labeling information with a particular destination location. Each device on a network has a unique number, usually called a *hardware address* or *MAC address*, that is used by the data link layer protocol to ensure that data intended for a specific machine gets to it properly.
- ⑤ **Error Detection and Handling:** The data link layer handles errors that occur at the lower levels of the network stack. For example, a cyclic redundancy check (CRC) field is often employed to allow the station receiving data to detect if it was received correctly.

Physical Layer Requirements Definition and Network Interconnection Device Layers

As I mentioned in [the topic discussing the physical layer](#), that layer and the data link layer are very closely related. The requirements for the physical layer of a network are often part of the data link layer definition of a particular technology. Certain physical layer hardware and encoding aspects are specified by the DLL technology being used. The best example of this is the Ethernet standard, IEEE 802.3, which specifies not just how Ethernet works at the data link layer, but also its various physical layers.

Since the data link layer and physical layer are so closely related, many types of hardware are associated with the data link layer. Network interface cards (NICs) typically implement a specific data link layer technology, so they are often called “Ethernet cards”, “Token Ring cards”, and so on. There are also a number of network interconnection devices that are said to “operate at layer 2”, in whole or in part, because they make decisions about what to do with data they receive by looking at data link layer frames. These devices include most bridges, switches and routers, though the latter two also encompass functions performed by layer three.

Some of the most popular technologies and protocols generally associated with layer 2 are Ethernet, Token Ring, FDDI (plus CDDI), HomePNA, IEEE 802.11, ATM, and TCP/IP's Serial Link Interface Protocol (SLIP) and Point-To-Point Protocol (PPP).



Key Concept: The second OSI Reference Model layer is the *data link layer*. This is the place where most LAN and wireless LAN technologies are defined. Layer two is responsible for logical link control, media access control, hardware addressing, error detection and handling, and defining physical layer standards. It is often divided into the logical link control (LLC) and media access control (MAC) sublayers, based on the IEEE 802 Project that uses that architecture.

Network Layer (Layer 3)

The third-lowest layer of the OSI Reference Model is the *network layer*. If the data link layer is the one that basically defines the boundaries of what is considered a network, the network layer is the one that defines how *internetworks* (interconnected networks) function. The network layer is the lowest one in the OSI model that is concerned with actually getting data from one computer to another even if it is on a remote network; in contrast, the data link layer only deals with devices that are local to each other.

While all of layers 2 through 6 in the OSI Reference Model serve to act as “fences” between the layers below them and the layers above them, the network layer is particularly important in this regard. It is at this layer that the transition really begins from the more abstract functions of the higher layers—which don't concern themselves as much with data delivery—into the specific tasks required to get data to its destination. The [transport layer](#), which is related to the network layer in a number of ways, continues this “abstraction transition” as you go up the OSI protocol stack.

Network Layer Functions

Some of the specific jobs normally performed by the network layer include:

-
- ④ **Logical Addressing:** Every device that communicates over a network has associated with it a logical address, sometimes called a *layer three* address. For example, on the Internet, the Internet Protocol (IP) is the network layer protocol and every machine has an IP address. Note that addressing is done at the data link layer as well, but those addresses refer to local physical devices. In contrast, logical addresses are independent of particular hardware and must be unique across an entire internetwork.
 - ④ **Routing:** Moving data across a series of interconnected networks is probably the defining function of the network layer. It is the job of the devices and software routines that function at the network layer to handle incoming packets from various sources, determine their final destination, and then figure out where they need to be sent to get them where they are supposed to go. I discuss routing in the OSI model more completely in this topic on [the topic on indirect device connection](#), and show how it works by way of an [OSI model analogy](#).
 - ④ **Datagram Encapsulation:** The network layer normally [encapsulates](#) messages received from higher layers by placing them into *datagrams* (also called *packets*) with a network layer header.
 - ④ **Fragmentation and Reassembly:** The network layer must send messages down to the data link layer for transmission. Some data link layer technologies have limits on the length of any message that can be sent. If the packet that the network layer wants to send is too large, the network layer must split the packet up, send each piece to the data link layer, and then have pieces reassembled once they arrive at the network layer on the destination machine. A good example is [how this is done by the Internet Protocol](#).
 - ④ **Error Handling and Diagnostics:** Special protocols are used at the network layer to allow devices that are logically connected, or that are trying to route traffic, to exchange information about the status of hosts on the network or the devices themselves.

Network Layer Connection-Oriented and Connectionless Services

Network layer protocols may offer either [connection-oriented or connectionless services](#) for delivering packets across the network. Connectionless ones are by far more common at the network layer. In many protocol suites, the network layer protocol is connectionless, and connection-oriented services are provided by the transport layer. For example, in TCP/IP, the Internet Protocol (IP) is connectionless, while the layer four Transmission Control Protocol (TCP) is connection-oriented.

The most common network layer protocol is of course the [Internet Protocol \(IP\)](#), which is why I have already mentioned it a couple of times. IP is the backbone of the Internet, and the foundation of the entire TCP/IP protocol suite. There are also several protocols directly related to IP that work with it at the network layer, such as [IPsec](#), [IP NAT](#) and [Mobile IP](#). [ICMP](#) is the main error-handling and control protocol that is used along with IP. Another notable network layer protocol outside the TCP/IP world is the Novell IPX protocol.



Key Concept: The OSI Reference Model's third layer is called the *network layer*. This is one of the most important layers in the model; it is responsible for the tasks that link together individual networks into *internetworks*. Network layer functions include internetwork-level addressing, routing, datagram encapsulation, fragmentation and reassembly, and certain types of error handling and diagnostics. The network layer and transport layer are closely related to each other.

The network interconnection devices that operate at the network layer are usually called *routers*, which at this point should hopefully come as no surprise to you. They are responsible for the routing functions I have mentioned, by taking packets received as they are sent along each “hop” of a route and sending them on the next leg of their trip. They communicate with each other using routing protocols, to determine the best routes for sending traffic efficiently. So-called “brouters” also reside at least in part at the network layer, as do the rather obviously named “layer three switches”. ☺

Transport Layer (Layer 4)

The fourth and “middle” layer of the OSI Reference Model protocol stack is the *transport layer*. I consider the transport layer in some ways to be part of both the [lower and upper “groups” of layers](#) in the OSI model. It is more often associated with the lower layers, because it concerns itself with the *transport* of data, but its functions are also somewhat high-level, resulting in the layer having a fair bit in common with layers 5 through 7 as well.

Recall that layers 1, 2 and 3 are concerned with the actual packaging, addressing, routing and delivery of data; the physical layer handles the bits; the data link layer deals with local networks and the network layer handles routing between networks. The transport layer, in contrast, is sufficiently conceptual that it no longer concerns itself with these “nuts and bolts” matters. It relies on the lower layers to handle the process of moving data between devices.

The transport layer really acts as a “liaison” of sorts between the abstract world of applications at the higher layers, and the concrete functions of layers one to three. Due to this role, the transport layer's overall job is to provide the necessary functions to enable communication between software application processes on different computers. This encompasses a number of different but related duties

Modern computers are multitasking, and at any given time may have many different software applications all trying to send and receive data. The transport layer is charged with providing a means by which these applications can all send and receive data using the same lower-layer protocol implementation. Thus, the transport layer is sometimes said to be responsible for *end-to-end* or *host-to-host* transport (in fact, the equivalent layer in the [TCP/IP model](#) is called the “host-to-host transport layer”).

Transport Layer Services and Transmission Quality

Accomplishing this communication between processes requires that the transport layer perform several different, but related jobs. For transmission, the transport layer protocol must keep track of what data comes from each application, then combine this data into a single flow of data to send to the lower layers. The device receiving information must reverse these operations, splitting data and funneling it to the appropriate recipient processes. The transport layer is also responsible for defining the means by which potentially large amounts of application data are divided into smaller blocks for transmission.

Another key function of the transport layer is to provide *connection services* for the protocols and applications that run at the levels above it. These can be categorized as either [connection-oriented services](#) or [connectionless services](#). Neither is better or worse than the other; they each have their uses. While connection-oriented services can be handled at the network layer as well, they are more often seen in the transport layer in the “real world”. Some protocol suites, such as TCP/IP, provide both a connection-oriented and a connectionless transport layer protocol, to suit the needs of different applications.

The transport layer is also the place in the layer stack where functions are normally included to add features to end-to-end data transport. Where network layer protocols are normally concerned with just “best effort” communications, where delivery is not guaranteed. Transport layer protocols are given intelligence in the form of algorithms that ensure that reliable and efficient communication between devices takes place. This encompasses several related jobs, including lost transmission detection and handling, and managing the rate at which data is sent to ensure that the receiving device is not overwhelmed.

Transmission quality, meaning ensuring that transmissions are received as sent, is so important that some networking references define the transport layer on the basis of reliability and flow-control functions. However, not all transport layer protocols provide these services. Just as a protocol suite may have a connection-oriented and a connectionless transport layer protocol, it may also have one that provides reliability and data management services, and one that does not. Again, this is the case with TCP/IP: there is one main transport layer protocol, TCP, that includes reliability and flow control features, and a second, UDP, that doesn't.

Transport Layer Functions

Let's look at the specific functions often performed at the transport layer in more detail:

- ☉ **Process-Level Addressing:** Addressing at layer two deals with hardware devices on a local network, and layer three addressing identifies devices on a logical internetwork. Addressing is also performed at the transport layer, where it is used to differentiate between software programs. This is part of what enables many different software programs to use a network layer protocol simultaneously, as mentioned above. The best example of transport-layer process-level addressing is the [TCP and UDP port mechanism](#) used in TCP/IP, which allows applications to be individually referenced on any TCP/IP device.

-
- ④ **Multiplexing and Demultiplexing:** Using the addresses I just mentioned, transport layer protocols on a sending device *multiplex* the data received from many application programs for transport, combining them into a single stream of data to be sent. The same protocols receive data and then *demultiplex* it from the incoming stream of datagrams, and direct each package of data to the appropriate recipient application processes.
 - ④ **Segmentation, Packaging and Reassembly:** The transport layer segments the large amounts of data it sends over the network into smaller pieces on the source machine, and then reassemble them on the destination machine. This function is similar conceptually to the fragmentation function of the network layer; just as the network layer fragments messages to fit the limits of the data link layer, the transport layer segments messages to suit the requirements of the underlying network layer.
 - ④ **Connection Establishment, Management and Termination:** Transport layer connection-oriented protocols are responsible for the series of communications required to establish a connection, maintain it as data is sent over it, and then terminate the connection when it is no longer required.
 - ④ **Acknowledgments and Retransmissions:** As mentioned above, the transport layer is where many protocols are implemented that guarantee reliable delivery of data. This is done using a variety of techniques, most commonly the combination of *acknowledgments* and *retransmission timers*. Each time data is sent a timer is started; if it is received, the recipient sends back an acknowledgment to the transmitter to indicate successful transmission. If no acknowledgment comes back before the timer expires, the data is retransmitted. Other algorithms and techniques are usually required to support this basic process.
 - ④ **Flow Control:** Transport layer protocols that offer reliable delivery also often implement *flow control* features. These features allow one device in a communication to specify to another that it must "throttle back" the rate at which it is sending data, to avoid bogging down the receiver with data. These allow mismatches in speed between sender and receiver to be detected and dealt with.

Relationship Between the Transport Layer and Network Layer

In theory, the transport layer and network layer are distinct, but in practice, they are often very closely related to each other. You can see this easily just by looking at the names of common protocol stacks—they are often named after the layer three and four protocols in the suite, implying their close relationship. For example, the name "TCP/IP" comes from the suite's most commonly used transport layer protocol (TCP) and network layer protocol (IP). Similarly, the Novell NetWare suite is often called "IPX/SPX" for its layer three (IPX) and layer four (SPX) protocols. Typically, specific transport layer protocols use the network layers in the same family. You won't often find a network using the transport layer protocol from one suite and the network layer protocol from another.

The most commonly used transport layer protocols are the Transmission Control Protocol (TCP) and User Datagram Protocol (UDP) in the TCP/IP suite, the Sequenced Packet Exchange (SPX) protocol in the NetWare protocol suite, and the NetBEUI protocol in the NetBIOS/NetBEUI/NBF suite (though NetBEUI is more difficult to categorize.)



Key Concept: The fourth and middle OSI Reference Model layer is the *transport layer*. This is another very important conceptual layer in the model; it represents the transition point between the lower layers that deal with data delivery issues, and the higher layers that work with application software. The transport layer is responsible for enabling *end-to-end communication* between application processes, which it accomplishes in part through the use of process-level addressing and multiplexing/demultiplexing. Transport layer protocols are responsible for dividing application data into blocks for transmission, and may be either connection-oriented or connectionless. Protocols at this layer also often provide data delivery management services such as reliability and flow control.

Session Layer (Layer 5)

The fifth layer in the OSI Reference Model is the *session layer*. As we proceed up the OSI layer stack from the bottom, the session layer is the first one where pretty much all practical matters related to the addressing, packaging and delivery of data are left behind—they are functions of layers four and below. It is the lowest of the three upper layers, which collectively are concerned mainly with software application issues and not with the details of network and internet implementation.

The name of this layer tells you much about what it is designed to do: to allow devices to establish and manage *sessions*. In general terms, a session is a persistent logical linking of two software application processes, to allow them to exchange data over a prolonged period of time. In some discussions, these sessions are called *dialogs*; they are roughly analogous to a telephone call made between two people.

Application Program Interfaces (APIs)

The primary job of session layer protocols is to provide the means necessary to set up, manage, and end sessions. In fact, in some ways, session layer software products are more sets of tools than specific protocols. These session-layer tools are normally provided to higher layer protocols through command sets often called *application program interfaces* or *APIs*.

Common APIs include NetBIOS, TCP/IP Sockets and Remote Procedure Calls (RPCs). They allow an application to accomplish certain high-level communications over the network easily, by using a standardized set of services. Most of these session-layer tools are of primary interest to the developers of application software. The programmers use the APIs to write software that is able to communicate using TCP/IP without having to know the implementation details of how TCP/IP works.

For example, the Sockets interface lies conceptually at layer five and is used by TCP/IP application programmers to create sessions between software programs over the Internet on the UNIX operating system. Windows Sockets similarly lets programmers create

Windows software that is Internet-capable and able to interact easily with other software that uses that interface. (Strictly speaking, Sockets is not a protocol, but rather a programming method.)

Session Layer Functions

As I have mentioned in a few places in this Guide, the boundaries between layers start to get very fuzzy once you get to the session layer, which makes it hard to categorize what exactly belongs at layer 5. Some technologies really span layers 5 through 7, and especially in the world of TCP/IP, it is not common to identify protocols that are specific to the OSI session layer.

The term “session” is somewhat vague, and this means that there is sometimes disagreement on the specific functions that belong at the session layer, or even whether certain protocols belong at the session layer or not. To add to this potential confusion, there is the matter of differentiating between a “connection” and a “session”. Connections are normally the province of layer four and layer three, yet a [Transmission Control Protocol \(TCP\)](#) connection, for example, can persist for a long time. The longevity of TCP connections makes them hard to distinguish from “sessions” (and in fact there are some people who feel that the [TCP/IP host-to-host transport layer](#) really straddles OSI layers four and five).



Key Concept: The fifth layer in the OSI Reference Model layer is the *session layer*. As its name suggests, it is the layer intended to provide functions for establishing and managing sessions between software processes. Session layer technologies are often implemented as sets of software tools called *application program interfaces (APIs)*, which provide a consistent set of services that allow programmers to develop networking applications without needing to worry about lower-level details of transport, addressing and delivery.

Presentation Layer (Layer 6)

The *presentation layer* is the sixth layer of the OSI Reference Model protocol stack, and second from the top. It is different from the other layers in two key respects. First, it has a much more limited and specific function than the other layers; it's actually somewhat easy to describe, hurray! Second, it is used much less often than the other layers; in many types of connections it is not required.

The name of this layer suggests its main function as well: it deals with the *presentation* of data. More specifically, the presentation layer is charged with taking care of any issues that might arise where data sent from one system needs to be viewed in a different way by the other system. It also takes care of any special processing that must be done to data from the time an application tries to send it until the time it is sent over the network.

Presentation Layer Functions

Here are some of the specific types of data handling issues that the presentation layer handles:

- ☉ **Translation:** Networks can connect very different types of computers together: PCs, Macintoshes, UNIX systems, AS/400 servers and mainframes can all exist on the same network. These systems have many distinct characteristics and represent data in different ways; they may use different character sets for example. The presentation layer handles the job of hiding these differences between machines.
- ☉ **Compression:** Compression (and decompression) may be done at the presentation layer to improve the throughput of data. (There are some who believe this is not, strictly speaking, a function of the presentation layer.)
- ☉ **Encryption:** Some types of encryption (and decryption) are performed at the presentation layer. This ensures the security of the data as it travels down the protocol stack. For example, one of the most popular encryption schemes that is usually associated with the presentation layer is the Secure Sockets Layer (SSL) protocol. Not all encryption is done at layer 6, however; some encryption is often done at lower layers in the protocol stack, in technologies such as [IPSec](#).

Presentation Layer Role in the OSI Model

The reason that the presentation layer is not always used in network communications is that the jobs mentioned above are simply not always needed. Compression and encryption are usually considered “optional”, and translation features are also only needed in certain circumstances. Another reason why the presentation layer is sometimes not mentioned is that its functions may be performed as part of the application layer.

The fact that the translation job done by the presentation layer isn't always needed means that it is common for it to be “skipped” by actual protocol stack implementations. This means that protocols at layer seven may talk directly with those at layer five. Once again, this is part of the reason why all of the functions of layers five through seven may be included together in the same software package, as described in the [overview of layers and layer groupings](#).



Key Concept: The sixth OSI model layer is called the *presentation layer*. Protocols at this layer take care of manipulation tasks that transform data from one representation to another, such as translation, compression and encryption. In many cases, no such functions are required in a particular networking stack; if so, there may not be any protocol active at layer six.

Application Layer (Layer 7)

At the very top of the OSI Reference Model stack of layers, we find layer 7, the *application layer*. Continuing the trend that we saw in layers 5 and 6, this one too is named very appropriately: the application layer is the one that is used by network applications. These programs are what actually implement the functions performed by users to accomplish various tasks over the network.

It's important to understand that what the OSI model calls an “application” is not exactly the same as what we normally think of as an “application”. In the OSI model, the application layer provides services for user applications to employ. For example, when you use your Web browser, that actual software is an application running on your PC. It doesn't really “reside” at the application layer. Rather, it makes use of the services offered by a protocol that operates at the application layer, which is called the [Hypertext Transfer Protocol \(HTTP\)](#). The distinction between the browser and HTTP is subtle, but important.

The reason for pointing this out is because not all user applications use the application layer of the network in the same way. Sure, your Web browser does, and so does your e-mail client and your Usenet news reader. But if you use a text editor to open a file on another machine on your network, that editor is not using the application layer. In fact, it has no clue that the file you are using is on the network: it just sees a file addressed with a name that has been mapped to a network somewhere else. The operating system takes care of *redirecting* what the editor does, over the network.

Similarly, not all uses of the application layer are by applications. The operating system itself can (and does) use services directly at the application layer.

That caveat aside, under normal circumstances, whenever you interact with a program on your computer that is designed specifically for use on a network, you are dealing directly with the application layer. For example, sending an e-mail, firing up a Web browser, or using an IRC chat program—all of these involve protocols that reside at the application layer.

There are dozens of different application layer protocols that enable various functions at this layer. Some of the most popular ones include HTTP, FTP, SMTP, DHCP, NFS, Telnet, SNMP, POP3, NNTP and IRC. Lots of alphabet soup, sorry. ☺ I describe all of these and more in [the chapter on higher-layer protocols and applications](#).

As the “top of the stack” layer, the application layer is the only one that does not provide any services to the layer above it in the stack—there isn't one! Instead, it provides services to programs that want to use the network, and to you, the user. So the responsibilities at this layer are simply to implement the functions that are needed by users of the network. And, of course, to issue the appropriate commands to make use of the services provided by the lower layers.



Key Concept: The seventh and highest layer in the OSI Reference Model is the *application layer*. Application protocols are defined at this layer, which implement specific user applications and other high-level functions. Since they are at the top of the stack, application protocols are the only ones that do not provide services to a higher layer; they make use of services provided by the layers below.

As we've [discussed elsewhere](#), the distinctions between the top layers are not very clear, and this is largely because of the decision made to not separate out session, presentation and application layer functions in the important [TCP/IP protocol suite](#). All of the protocols mentioned above are from the TCP/IP protocol family, and some may cover all three of the top three OSI layers, two of them, or one; in the [TCP/IP model](#), they are all applications.



OSI Reference Model Layer Mnemonics

If you spend any amount of time at all dealing with networking design or implementation issues, or learning about how the various protocols operate, the names and numbers of the various layers will eventually become “second nature”. Trust me, I know this from experience!

Many people, however, especially those just learning about networks, find it difficult to recall the names of all the layers, and especially, what their exact order is. To help these people, a number of *mnemonics* (pronounced “neh-MON-iks”—another wonder of the English language) have been created as memory aids. These are cute phrases where each word starts with the first letter of an OSI model layer, arranged in the correct order.

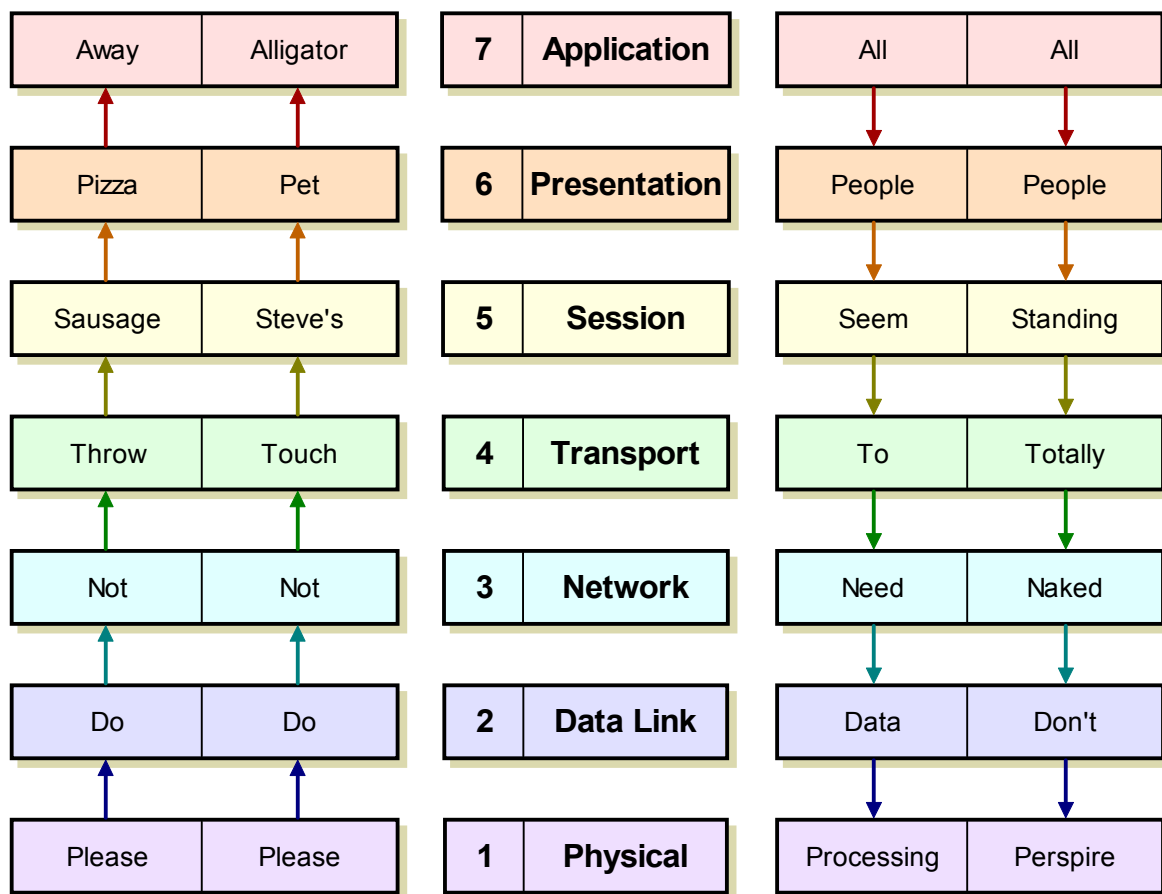

Figure 18: OSI Reference Model Mnemonics

These mnemonics may help you to remember the order of the OSI Reference Model layers.

I have seen a few of them in my time, some of which go in ascending layer number order, and some of which go in the other direction. These two go from physical layer to application layer:

- ☉ Please Do Not Throw Sausage Pizza Away
- ☉ Please Do Not Touch Steve's Pet Alligator

And these ones go the other direction (application to physical):

- ☹ All People Seem To Need Data Processing (this is a popular one)
- ☹ All People Standing Totally Naked Don't Perspire (hmm, that's interesting...)

For your convenience, I have illustrated all four of these in [Figure 18](#).

Oh, and here's one I just made up: All People Should Teach Networking Daily Please.

(Well, / like it! 😊)



OSI Reference Model Layer Summary

To assist you in quickly comparing the layers of the OSI Reference Model, and understanding where they are different and how they relate to each other, I have created the summary chart shown in [Table 19](#). It shows each layer's name and number, describes its key responsibilities, talks about what type of data is generally handled at each layer, and also what the scope of each layer is in approximate terms. I also show some of the more common protocols that are associated with each layer.

I will say here that “standard disclaimers apply”. I don't want to repeat all of the caveats I mentioned elsewhere in discussions of the OSI model, but know that they apply here as well. Namely: the layers aren't always hard-fast, I haven't listed every single protocol here, some may really fit into more than one layer, and so on. In particular, note that many of the technologies listed as being in the data link layer are there because that is the layer where their primary functionality resides. In reality, most of these technologies include components in other layers, especially the physical layer.

Table 19: OSI Reference Model Layer Summary (Page 1 of 2)

Group	#	Layer Name	Key Responsibilities	Data Type Handled	Scope	Common Protocols and Technologies
Lower Layers	1	Physical	Encoding and Signaling; Physical Data Transmission; Hardware Specifications; Topology and Design	Bits	Electrical or light signals sent between local devices	(Physical layers of most of the technologies listed for the data link layer)
	2	Data Link	Logical Link Control; Media Access Control; Data Framing; Addressing; Error Detection and Handling; Defining Requirements of Physical Layer	Frames	Low-level data messages between local devices	IEEE 802.2 LLC, Ethernet Family; Token Ring; FDDI and CDDI; IEEE 802.11 (WLAN, Wi-Fi); HomePNA; HomeRF; ATM; SLIP and PPP
	3	Network	Logical Addressing; Routing; Datagram Encapsulation; Fragmentation and Reassembly; Error Handling and Diagnostics	Datagrams / Packets	Messages between local or remote devices	IP; IPv6; IP NAT; IPsec; Mobile IP; ICMP; IPX; DLC; PLP; Routing protocols such as RIP and BGP
	4	Transport	Process-Level Addressing; Multiplexing/Demultiplexing; Connections; Segmentation and Reassembly; Acknowledgments and Retransmissions; Flow Control	Datagrams / Segments	Communication between software processes	TCP and UDP; SPX; NetBEUI/NBF

Table 19: OSI Reference Model Layer Summary (Page 2 of 2)

Group	#	Layer Name	Key Responsibilities	Data Type Handled	Scope	Common Protocols and Technologies
Upper Layers	5	Session	Session Establishment, Management and Termination	Sessions	Sessions between local or remote devices	NetBIOS, Sockets, Named Pipes, RPC
	6	Presentation	Data Translation; Compression and Encryption	Encoded User Data	Application data representations	SSL; Shells and Redirectors; MIME
	7	Application	User Application Services	User Data	Application data	DNS; NFS; BOOTP; DHCP; SNMP; RMON; FTP; TFTP; SMTP; POP3; IMAP; NNTP; HTTP; Telnet



TCP/IP Protocol Suite and Architecture

Just as Ethernet rules the roost when it comes to LAN technologies and IEEE 802.11 is the boss of the wireless LAN world, modern internetworking is dominated by the suite known as *TCP/IP*. Named for two key protocols of the many that comprise it, TCP/IP has been in continual development and use for about three decades. In that time, it has evolved from an experimental technology used to hook together a handful of research computers, to the powerhouse of the largest and most complex computer network in history: the global Internet, connecting together millions of networks and end devices.

In this section I begin our magical tour through the mystical world of TCP/IP. ☺ I begin with an overview of TCP/IP and a brief look at its very interesting history. I discuss the services provided in TCP/IP networks, and then explain the architectural model used under TCP/IP. I then provide a brief description of each of the most important TCP/IP protocols that are discussed in this Guide.

You may have noticed that this section is relatively small, even though its title seems to encompass the entire subject of this TCP/IP Guide. The reason is that this section only provides a high-level overview of TCP/IP. Most of the content of the Guide is concerned with explaining the several dozen individual protocols that comprise TCP/IP; these can be found in other sections and subsections of the Guide. For convenience, you can also find direct links to the descriptions of these protocols in the [TCP/IP Protocols](#) topic in this section.

TCP/IP Overview and History

The best place to start looking at TCP/IP is probably the name itself. TCP/IP in fact consists of dozens of different protocols, but only a few are the “main” protocols that define the core operation of the suite. Of these key protocols, two are usually considered the most important. The *Internet Protocol (IP)* is the primary OSI network layer (layer three) protocol that provides addressing, datagram routing and other functions in an internetwork. The *Transmission Control Protocol (TCP)* is the primary transport layer (layer four) protocol, and is responsible for connection establishment and management and reliable data transport between software processes on devices.

Due to the importance of these two protocols, their abbreviations have come to represent the entire suite: “TCP/IP”. (In a moment we'll discover exactly the history of that name.) IP and TCP are important because many of TCP/IP's most critical functions are implemented at layers three and four. However, there is much more to TCP/IP than just TCP and IP. The protocol suite as a whole requires the work of many different protocols and technologies to make a functional network that can properly provide users with the applications they need.

TCP/IP uses its own four-layer architecture that corresponds roughly to the OSI Reference Model and provides a framework for the various protocols that comprise the suite. It also includes numerous high-level applications, some of which are well-known by Internet users

who may not realize they are part of TCP/IP, such as [HTTP](#) (which runs the World Wide Web) and [FTP](#). In the topics on [TCP/IP architecture](#) and [protocols](#) I provide an overview of most of the important TCP/IP protocols and how they fit together.

Early TCP/IP History

As I said earlier, the Internet is a primary reason why TCP/IP is what it is today. In fact, the Internet and TCP/IP are so closely related in their history that it is difficult to discuss one without also talking about the other. They were developed together, with TCP/IP providing the mechanism for implementing the Internet. TCP/IP has over the years continued to evolve to meet the needs of the Internet and also smaller, private networks that use the technology. I will provide a brief summary of the history of TCP/IP here; of course, whole books have been written on TCP/IP and Internet history, and this is a technical Guide and not a history book, so remember that this is just a quick look for sake of interest.

The TCP/IP protocols were initially developed as part of the research network developed by the United States *Defense Advanced Research Projects Agency* (*DARPA* or *ARPA*). Initially, this fledgling network, called the *ARPAnet*, was designed to use a number of protocols that had been adapted from existing technologies. However, they all had flaws or limitations, either in concept or in practical matters such as capacity, when used on the ARPAnet. The developers of the new network recognized that trying to use these existing protocols might eventually lead to problems as the ARPAnet scaled to a larger size and was adapted for newer uses and applications.

In 1973, development of a full-fledged system of internetworking protocols for the ARPAnet began. What many people don't realize is that in early versions of this technology, there was only one core protocol: TCP. And in fact, these letters didn't even stand for what they do today; they were for the *Transmission Control Program*. The first version of this predecessor of modern TCP was written in 1973, then revised and formally documented in RFC 675, *Specification of Internet Transmission Control Program*, December 1974.



Note: Note: Internet standards are defined in documents called *Requests For Comments (RFCs)*. These documents, and the process used to create them, are described in [their own topic of the section on networking fundamentals](#).

Modern TCP/IP Development and the Creation of TCP/IP Architecture

Testing and development of TCP continued for several years. In March 1977, version 2 of TCP was documented. In August 1977, a significant turning point came in TCP/IP's development. Jon Postel, one of the most important pioneers of the Internet and TCP/IP, published a set of comments on the state of TCP. In that document (known as *Internet*

Engineering Note number 2, or IEN 2), he provided what I consider superb evidence that [reference models and layers aren't just for textbooks](#), and really **are** important to understand:

We are screwing up in our design of internet protocols by violating the principle of layering. Specifically we are trying to use TCP to do two things: serve as a host level end to end protocol, and to serve as an internet packaging and routing protocol. These two things should be provided in a layered and modular way. I suggest that a new distinct internetwork protocol is needed, and that TCP be used strictly as a host level end to end protocol.

-- Jon Postel, IEN 2, 1977

What Postel was essentially saying was that the version of TCP created in the mid-1970s was trying to do too much. Specifically, it was encompassing both layer three and layer four activities (in terms of [OSI Reference Model layer numbers](#)). His vision was prophetic, because we now know that having TCP handle all of these activities would have indeed led to problems down the road.

Postel's observation led to the creation of [TCP/IP architecture](#), and the splitting of TCP into TCP at the transport layer and IP at the network layer; thus the name "TCP/IP". (As an aside, it's interesting, given this history, that sometimes the entire TCP/IP suite is called just "IP", even though TCP came first.) The process of dividing TCP into two portions began in version 3 of TCP, written in 1978. The first formal standard for the versions of IP and TCP used in modern networks (version 4) were created in 1980. This is why the first "real" version of IP is version 4 and not version 1. TCP/IP quickly became the standard protocol set for running the ARPAnet. In the 1980s, more and more machines and networks were connected to the evolving ARPAnet using TCP/IP protocols, and the TCP/IP Internet was born.



Key Concept: TCP/IP was initially developed in the 1970s as part of an effort to define a set of technologies to operate the fledgling Internet. The name "TCP/IP" came about when the original Transmission Control Program (TCP) was split into the Transmission Control Protocol (TCP) and Internet Protocol (IP). The first modern versions of these two key protocols were documented in 1980 as TCP version 4 and IP version 4.

Important Factors in the Success of TCP/IP

TCP/IP was at one time just "one of many" different sets of protocols that could be used to provide network-layer and transport-layer functionality. Today there are still other options for internetworking protocol suites, but TCP/IP is the universally-accepted world-wide standard. Its growth in popularity has been due to a number of important factors. Some of

these are historical, such as the fact that it is tied to the Internet as described above, while others are related to the characteristics of the protocol suite itself. Chief among these are the following:

- ④ **Integrated Addressing System:** TCP/IP includes within it (as part of the [Internet Protocol](#), primarily) [a system for identifying and addressing devices](#) on both small and large networks. The addressing system is designed to allow devices to be addressed regardless of the lower-level details of how each constituent network is constructed. Over time, the mechanisms for addressing in TCP/IP have improved, to meet the needs of growing networks, especially the Internet. The addressing system also includes a [centralized administration capability](#) for the Internet, to ensure that each device has a unique address.
- ④ **Design For Routing:** Unlike some network-layer protocols, TCP/IP is specifically designed to [facilitate the routing of information](#) over a network of arbitrary complexity. In fact, TCP/IP is conceptually concerned more with the connection of networks, than with the connection of devices. TCP/IP routers enable data to be delivered between devices on different networks by moving it one step at a time from one network to the next. A number of [support protocols](#) are also included in TCP/IP to allow routers to exchange critical information and manage the efficient flow of information from one network to another.
- ④ **Underlying Network Independence:** TCP/IP operates primarily at layers three and above, and includes provisions to allow it to function on almost any lower-layer technology, including LANs, wireless LANs and WANs of various sorts. This flexibility means that one can mix and match a variety of different underlying networks and connect them all using TCP/IP.
- ④ **Scalability:** One of the most amazing characteristics of TCP/IP is how scalable its protocols have proven to be. Over the decades it has proven its mettle as the Internet has grown from a small network with just a few machines to a huge internetwork with millions of hosts. While some changes have been required periodically to support this growth, these changes have taken place as part of the TCP/IP development process, and the core of TCP/IP is basically the same as it was 25 years ago.
- ④ **Open Standards and Development Process:** The TCP/IP standards are not proprietary, but [open standards](#) freely available to the public. Furthermore, the process used to develop TCP/IP standards is also completely open. TCP/IP standards and protocols are developed and modified using the unique, democratic [“RFC” process](#), with all interested parties invited to participate. This ensures that anyone with an interest in the TCP/IP protocols is given a chance to provide input into their development, and also ensures the world-wide acceptance of the protocol suite.
- ④ **Universality:** Everyone uses TCP/IP because everyone uses it!

This last point is, perhaps ironically, arguably the most important. Not only is TCP/IP the “underlying language of the Internet”, it is also used in most private networks today. Even former “competitors” to TCP/IP such as NetWare now use TCP/IP to carry traffic. The Internet continues to grow, and so do the capabilities and functions of TCP/IP. Preparation for the future continues, with the move to [the new IP version 6 protocol](#) in its early stages. It is likely that TCP/IP will remain a big part of internetworking for the foreseeable future.



Key Concept: While TCP/IP is not the only internetworking protocol suite, it is definitely the most important one. Its unparalleled success is due to a wide variety of factors. These include its technical features, such as its routing-friendly design and scalability, its historical role as the protocol suite of the Internet, and its open standards and development process, which reduce barriers to acceptance of TCP/IP protocols.

TCP/IP Services and Client/Server Operation

TCP/IP is most often studied in terms of its layer-based architecture and the protocols that it provides at those different layers. And we're certainly going to do that, don't worry. These protocols, however, represent the technical details of **how** TCP/IP works. They are of interest to us as students of technology, but are normally hidden from users who do not need to see the "guts" of how TCP/IP works to know that it works. Before proceeding to these details, I think it might be instructive to take a "bigger picture" look at **what** TCP/IP does.

TCP/IP Services

In [the section describing the OSI Reference Model](#) I mentioned that the theoretical operation of the model is based on [the concept of one layer providing services to the layers above it](#). TCP/IP covers many layers of the OSI model, and so it collectively provides services of this sort as well in many ways. Conceptually, we can divide TCP/IP services into two groups: services provided to other protocols and services provided to end users directly.

Services Provided to Other Protocols

The first group of services consists of the core functions implemented by the main TCP/IP protocols such as [IP](#), [TCP](#) and [UDP](#). These services are designed to actually accomplish the internetworking functions of the protocol suite. For example, at the network layer, [IP provides functions](#) such as addressing, delivery, and datagram packaging, fragmentation and reassembly. At the transport layer, TCP and UDP are concerned with encapsulating user data and managing connections between devices. Other protocols provide routing and management functionality. Higher-layer protocols use these services, allowing them to concentrate on what they are intended to accomplish.

End-User Services

The other general types of service provided by TCP/IP are end-user services. These facilitate the operation of the applications that users run to make use of the power of the Internet and other TCP/IP networks. For example, the [World Wide Web \(WWW\)](#) is arguably the most important Internet application. WWW services are provided through the [Hypertext](#)

Transfer Protocol (HTTP), a TCP/IP application layer protocol. HTTP in turn uses services provided by lower-level protocols. All of these details are of course hidden from the end users, which is entirely on purpose!

The TCP/IP Client/Server Structural Model

An important defining characteristic of TCP/IP services is that they primarily operate in the *client/server* structural model. This term refers to a system where a relatively small number of (usually powerful) server machines is dedicated to providing services to a much larger number of client hosts; I describe the concept more in [the topic on network structural models](#) in the [networking fundamentals](#) chapter. Just as client/server networking applies to hardware, this same concept can be applied to software and protocols, and this is exactly what was done in the design of TCP/IP protocols and applications.

TCP/IP protocols are not set up so that two machines that want to communicate use identical software. Instead, a conscious decision was made to make communication function using matched, complementary pairs of client and server software. The client initiates communication by sending a request to a server for data or other information. The server then responds with a reply to the client, giving the client what it requested, or else an alternative response such as an error message or information about where else it might find the data. Most (but not all) TCP/IP functions work in this manner, which is illustrated in [Figure 19](#).

There are numerous advantages to client/server operation in TCP/IP. Just as client hardware and server hardware can be tailored to their very different jobs, client software and the server software can also be optimized to perform their jobs as efficiently as possible. Let's take again the WWW as another example. To get information from the Web, a Web client software (usually called a *browser*) sends requests to a Web server. The Web server then responds with the requested content. (There's more to it than that, of course, but that's how it appears to the user.) The Web browser is created to provide the interface to the user and to talk to Web servers; the Web server software is very different, generally consisting only of high-powered software that receives and responds to requests.



Key Concept: The TCP/IP protocol suite is strongly oriented around the notion of *client/server* network communication. Rather than all devices and protocol software elements being designed as peers, they are constructed as matched sets. Clients normally initiate communications by sending requests, and servers respond to such requests, providing the client with the desired data or an informative reply.

Understanding TCP/IP Client and Server Roles

The terms “client” and “server” can be confusing in TCP/IP because they are used in several different ways, sometimes simultaneously:

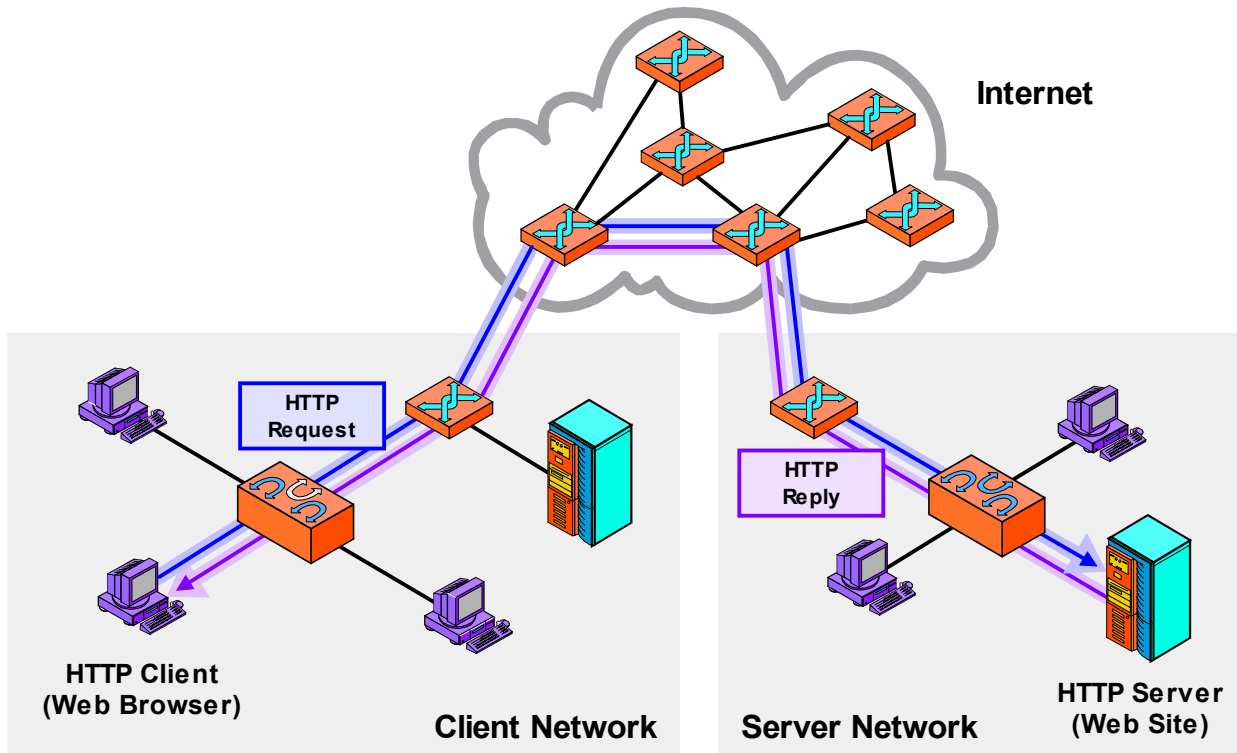

Figure 19: TCP/IP Client/Server Operation

Most TCP/IP protocols involve communication between two devices, but the two rarely act as peers in the communication; one acts as the *client* and the other as the *server*. This simplified illustration shows a common example—a [World Wide Web](#) transaction using the [Hypertext Transfer Protocol \(HTTP\)](#). The Web browser is an HTTP client and initiates the communication with a request for a file or other resource sent over the Internet to a Web site, which is an HTTP server. The server then responds to the client with the information requested. Servers will generally respond to many clients simultaneously.

- ☉ **Hardware Roles:** The terms “client” and “server” usually refer to the primary roles played by networked hardware. A “client” computer is usually something like a PC or Macintosh computer used by an individual, and primarily initiates conversations by sending requests. A “server” is usually a very high-powered machine dedicated to responding to client requests, sitting in a computer room somewhere that nobody but its administrator ever sees.
- ☉ **Software Roles:** As mentioned earlier, TCP/IP uses different pieces of software for many protocols to implement “client” and “server” roles. A Web browser is a piece of client software, while Web server software is completely different. Client software is usually found on client hardware and server software on server hardware, but **not always**. Some devices may run both client and server software.
- ☉ **Transactional Roles:** In any exchange of information, the client is normally the device that initiates communication or sends a query; the server responds, usually providing information. Again, usually the client software on a client device initiates the transaction, but this is not always the case.

So, in a typical organization there will be many smaller individual computers designated “clients”, and a few larger ones that are “servers”. The servers normally run server software, and the clients run client software. But servers can also be set up with client software, and clients with server software.

For example, suppose you are an administrator working in the computer room on server #1 and need to transfer a file to server #2. You fire up FTP to initiate a file-transfer session with server #2. In this transaction, server #1 is playing the role of the client, since it is initiating communication using an FTP client program. Theoretically, you could even start an FTP transfer from server #1 to a particular client, if that client had FTP server software to answer the server's request. (This is less common, because server software is often not installed on client machines.)

Transactional roles come into play when communication occurs between servers in certain protocols. For example, when two [SMTP](#) servers communicate to exchange electronic mail, even though they are both server programs running on server hardware, during any transaction one device acts as the client while the other acts as the server. In some cases, devices can even swap client and server roles in the middle of a session!

I should conclude by making clear that the client and server roles I have discussed above are the *traditional* ones. The rise of powerful personal computers and widespread Internet access (especially “always-on” broadband connectivity) has led to a significant blurring of client and server hardware and software. Many client machines now include server software to allow them to, for example, respond to World Wide Web queries from other clients. There are also many file sharing programs around that allow clients to communicate using the [peer-to-peer structural model](#). However, most TCP/IP communication is still client/server in nature, so it's important to keep these roles in mind.



Key Concept: Understanding client/server computing concepts in TCP/IP is made more complex due to the very different meanings that the terms “client” and “server” can have in various contexts. The two terms can refer to *hardware roles*—designations given to hardware devices based on whether they usually function as clients or as servers. The terms can also refer to *software roles*, meaning whether protocol software components function as clients or servers. Finally, they can refer to *transactional roles*, meaning whether a device and program functions as a client or server in any given exchange of data.

TCP/IP Architecture and the TCP/IP Model

The [OSI reference model](#) consists of seven layers that represent a functional division of the tasks required to implement a network. It is a conceptual tool that I often use to show how various protocols and technologies fit together to implement networks. However, it's not the only networking model that attempts to divide tasks into layers and components. The TCP/

IP protocol suite was in fact created before the OSI Reference Model; as such, its inventors didn't use the OSI model to explain TCP/IP architecture (even though the OSI model is often used in TCP/IP discussions today, as you will see in this Guide, believe me.)

The TCP/IP Model

The developers of the TCP/IP protocol suite created their own architectural model to help describe its components and functions. This model goes by different names, including the *TCP/IP model*, the *DARPA model* (after [the agency that was largely responsible for developing TCP/IP](#)) and the *DOD model* (after the United States Department of Defense, the “D” in “DARPA”). I just call it the TCP/IP model since this seems the simplest designation for modern times.

Regardless of the model you use to represent the function of a network—and regardless of what you call that model!—the functions that the model represents are pretty much the same. This means that the TCP/IP and the OSI models are really quite similar in nature even if they don't carve up the network functionality pie in precisely the same way. There is a fairly natural correspondence between the TCP/IP and OSI layers, it just isn't always a “one-to-one” relationship. Since the OSI model is used so widely, it is common to explain the TCP/IP architecture both in terms of the TCP/IP layers and the corresponding OSI layers, and that's what I will now do.

TCP/IP Model Layers

The TCP/IP model uses four layers that logically span the equivalent of the top six layers of the OSI reference model; this is shown in [Figure 20](#). (The physical layer is not covered by the TCP/IP model because the data link layer is considered the point at which the interface occurs between the TCP/IP stack and the underlying networking hardware.) The following are the TCP/IP model layers, starting from the bottom.

Network Interface Layer

As its name suggests, this layer represents the place where the actual TCP/IP protocols running at higher layers interface to the local network. This layer is somewhat “controversial” in that some people don't even consider it a “legitimate” part of TCP/IP. This is usually because none of the core IP protocols run at this layer. Despite this, the network interface layer is part of the architecture. It is equivalent to the [data link layer \(layer two\) in the OSI Reference Model](#) and is also sometimes called the *link layer*. You may also see the name *network access layer*.

On many TCP/IP networks, there is no TCP/IP protocol running at all on this layer, because it is simply not needed. For example, if you run TCP/IP over an Ethernet, then Ethernet handles layer two (and layer one) functions. However, the TCP/IP standards do define protocols for TCP/IP networks that do not have their own layer two implementation. These protocols, the [Serial Line Internet Protocol \(SLIP\)](#) and the [Point-to-Point Protocol \(PPP\)](#), serve to fill the gap between the network layer and the physical layer. They are commonly used to facilitate TCP/IP over direct serial line connections (such as dial-up telephone networking) and other technologies that operate directly at the physical layer.

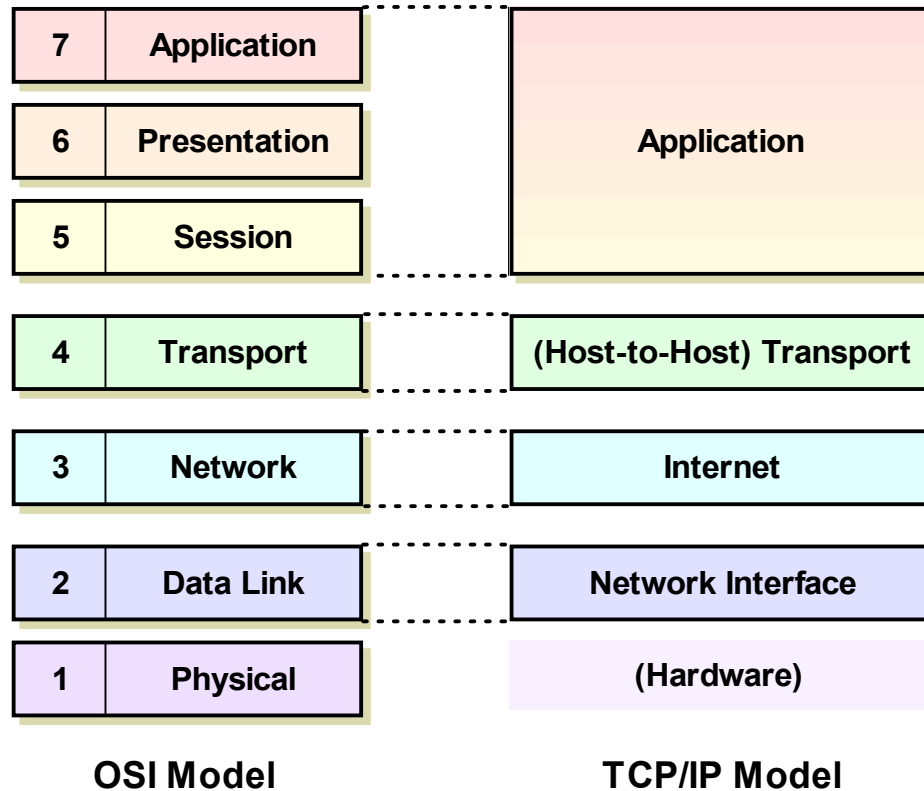

Figure 20: OSI Reference Model and TCP/IP Model Layers

The TCP/IP architectural model has four layers that approximately match six of the seven layers in the OSI Reference Model. The TCP/IP model does not address the physical layer, which is where hardware devices reside. The next three layers—*network interface*, *internet* and *(host-to-host) transport*—correspond to layers 2, 3 and 4 of the OSI model. The TCP/IP *application* layer conceptually “blurs” the top three OSI layers. It’s also worth noting that some people consider certain aspects of the OSI session layer to be arguably part of the TCP/IP host-to-host transport layer.

Internet Layer

This layer corresponds to the [network layer in the OSI Reference Model](#) (and for that reason is sometimes called the *network layer* even in TCP/IP model discussions). It is responsible for typical layer three jobs, such as logical device addressing, data packaging, manipulation and delivery, and last but not least, routing. At this layer we find the [Internet Protocol \(IP\)](#), arguably the heart of TCP/IP, as well as support protocols such as [ICMP](#) and the [routing protocols \(RIP, OSPF, BGP, etc.\)](#) The new version of IP, called [IP version 6](#), will be used for the Internet of the future and is of course also at this layer.

(Host-to-Host) Transport Layer

This primary job of this layer is to facilitate end-to-end communication over an internetwork. It is in charge of allowing logical connections to be made between devices to allow data to be sent either unreliably (with no guarantee that it gets there) or reliably (where the protocol

keeps track of the data sent and received to make sure it arrives, and re-sends it if necessary). It is also here that identification of the specific source and destination application process is accomplished

The formal name of this layer is often shortened to just the *transport layer*; the key TCP/IP protocols at this layer are the [Transmission Control Protocol \(TCP\)](#) and [User Datagram Protocol \(UDP\)](#). The TCP/IP transport layer corresponds to the layer of the same name in the OSI model ([layer four](#)) but includes certain elements that are arguably part of the OSI [session layer](#). For example, TCP establishes a connection that can persist for a long period of time, which some people say makes a TCP connection more like a session.

Application Layer

This is the highest layer in the TCP/IP model. It is a rather broad layer, encompassing layers five through seven in the OSI model. While this seems to represent a loss of detail compared to the OSI model, I think this is probably a good thing! The TCP/IP model better reflects the “blurry” nature of the divisions between the functions of the higher layers in the OSI model, which in practical terms often seem rather arbitrary. It really is hard to separate some protocols in terms of which of layers five, six or seven they encompass. (I didn't even bother to try in this Guide which is why [the higher-level protocols are all in the same chapter](#), while layers one through four have their protocols listed separately.)

Numerous protocols reside at the application layer. These include application protocols such as [HTTP](#), [FTP](#) and [SMTP](#) for providing end-user services, as well as administrative protocols like [SNMP](#), [DHCP](#) and [DNS](#).



Note: The internet and host-to-host transport layers are usually considered the “core” of TCP/IP architecture, since they contain most of the key protocols that implement TCP/IP internetworks.

In the topic that follows I provide a brief look at each of the TCP/IP protocols covered in detail in this Guide and more detail on where they all fit into the TCP/IP architecture. There I will also cover a couple of protocols that don't really fit into the TCP/IP layer model at all.



Key Concept: The architecture of the TCP/IP protocol suite is often described in terms of a layered reference model called the *TCP/IP model*, *DARPA model* or *DOD model*. The TCP/IP model includes four layers: the *network interface layer* (responsible for interfacing the suite to the physical hardware on which it runs), the *internet layer* (where device addressing, basic datagram communication and routing take place), the *host-to-host transport layer* (where connections are managed and reliable communication is ensured) and the *application layer* (where end-user applications and services reside.) The first three layers correspond to layers two through four of the OSI Reference Model respectively; the application layer is equivalent to OSI layers five to seven.

TCP/IP Protocols

Since TCP/IP is a protocol suite, it is most often discussed in terms of the protocols that comprise it. Each protocol “resides” in a particular layer of the [TCP/IP architectural model](#) we saw earlier in this section. Every TCP/IP protocol is charged with performing a certain subset of the total functionality required to implement a TCP/IP network or application. They work together to allow TCP/IP as a whole to operate.

First, a quick word on the word “protocol”. You will sometimes hear TCP/IP called just a “protocol” instead of a “protocol suite”. This is a simplification that while technically incorrect, is widely used. I believe it arises in large part due to Microsoft referring to protocol suites as “protocols” in their operating systems. I discuss this issue in more detail in a [topic devoted to protocols](#) in the [networking fundamentals chapter](#).

As I mentioned earlier in this section, there are a few TCP/IP protocols that are usually called the “core” of the suite, because they are responsible for its basic operation. Which protocols to include in this category is a matter of some conjecture, but most people would definitely include here the main protocols at the internet and transport layers: the [Internet Protocol \(IP\)](#), [Transmission Control Protocol \(TCP\)](#) and [User Datagram Protocol \(UDP\)](#). These core protocols support many other protocols, to perform a variety of functions at each of the TCP/IP model layers. Still others enable user applications to function.

On the whole, there are many hundreds of TCP/IP protocols and applications, and I could not begin to cover each and every one in this Guide. I do include sections discussing several dozen of the protocols that I consider important for one reason or another. Full coverage of each of these protocols (to varying levels of detail) can be found in the other chapters of this Guide.

Below I have included a number of tables that provide a summary of each of the TCP/IP protocols discussed in this Guide. Each table covers one of the TCP/IP model layers, in order from lowest to highest, and I have provided links to the sections or topics where each is discussed. The organization of protocols in the TCP/IP suite can also be seen at a glance in [Figure 21](#).

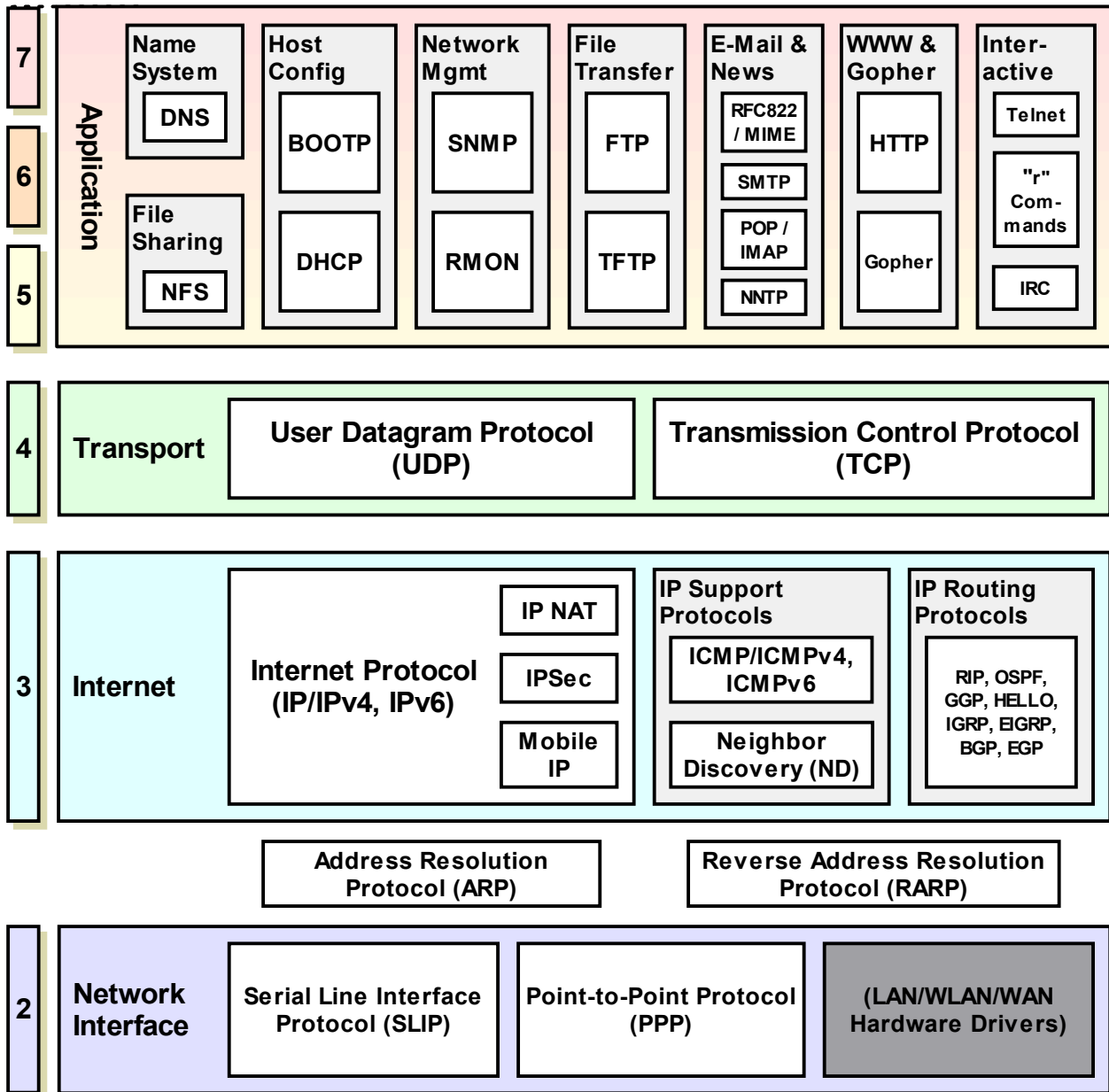

Figure 21: TCP/IP Protocols

This diagram shows all the TCP/IP protocols covered by this guide, arranged by TCP/IP and OSI Reference Model layer (with the exception of the administration utilities; there are so many and I ran out of space! ☺) I have also shown in the network interface layer where TCP/IP hardware drivers conceptually reside; these are used at layer two when TCP/IP is implemented on a LAN or WAN technology, rather than using SLIP or PPP.

Network Interface Layer (OSI Layer 2) Protocols

TCP/IP includes two protocols at the network interface layer, SLIP and PPP, which are described in [Table 20](#).

Table 20: TCP/IP Protocols: Network Interface Layer (OSI Layer 2)

Protocol Name	Protocol Abbr.	Description
Serial Line Internet Protocol (SLIP)	SLIP	Provides basic TCP/IP functionality by creating a layer-two connection between two devices over a serial line.
Point-to-Point Protocol	PPP	Provides layer-two connectivity like SLIP, but is much more sophisticated and capable. PPP is itself a suite of protocols (“sub-protocols” if you will) that allow for functions such as authentication, data encapsulation, encryption and aggregation, facilitating TCP/IP operation over WAN links.

Network Interface / Network Layer (“OSI Layer 2/3”) Protocols

[Table 21](#) describes ARP and RARP, the “oddballs” of the TCP/IP suite. In some ways they belong in both layer two and layer three, and in other ways neither. They really serve to link together the network interface layer and the internet layer. For this reason, I really believe they belong *between* these two and call them “layer connection” protocols. [See the section devoted to these protocols and their unique layer for more on this issue.](#)

Table 21: TCP/IP Protocols: Network Interface / Network Layer (“OSI Layer 2/3”)

Protocol Name	Protocol Abbr.	Description
Address Resolution Protocol	ARP	Used to map layer three IP addresses to layer two physical network addresses.
Reverse Address Resolution Protocol	RARP	Determines the layer three address of a machine from its layer two address. Now mostly superseded by BOOTP and DHCP.

Network Layer (OSI Layer 3) Protocols

The very important network layer contains the Internet Protocol and several related and support protocols, as shown in [Table 22](#).

Table 22: TCP/IP Protocols: Network Layer (OSI Layer 3)

Protocol Name	Protocol Abbr.	Description
Internet Protocol, Internet Protocol Version 6	IP, IPv6	Provides encapsulation and connectionless delivery of transport layer messages over a TCP/IP network. Also responsible for addressing and routing functions.
IP Network Address Translation	IP NAT	Allows addresses on a private network to be automatically translated to different addresses on a public network, providing address sharing and security benefits. (Note that some people don't consider IP NAT to be a protocol in the strict sense of that word.)
IP Security	IPSec	A set of IP-related protocols that improve the security of IP transmissions.
Internet Protocol Mobility Support	Mobile IP	Resolves certain problems with IP associated with mobile devices.
Internet Control Message Protocol	ICMP/ ICMPv4, ICMPv6	A "support protocol" for IP and IPv6 that provides error-reporting and information request-and-reply capabilities to hosts.
Neighbor Discovery Protocol	ND	A new "support protocol" for IPv6 that includes several functions performed by ARP and ICMP in conventional IP.
Routing Information Protocol, Open Shortest Path First, Gateway-to-Gateway Protocol, HELLO Protocol, Interior Gateway Routing Protocol, Enhanced Interior Gateway Routing Protocol, Border Gateway Protocol, Exterior Gateway Protocol	RIP, OSPF, GGP, HELLO, IGRP, EIGRP, BGP, EGP	Protocols used to support the routing of IP datagrams and the exchange of routing information.

Host-to-Host Transport Layer (OSI Layer 4) Protocols

The transport layer contains the essential protocols TCP and UDP, as shown in [Table 23](#).

Table 23: TCP/IP Protocols: Host-to-Host Transport Layer (OSI Layer 4)

Protocol Name	Protocol Abbr.	Description
Transmission Control Protocol	TCP	The main transport layer protocol for TCP/IP. Establishes and manages connections between devices and ensures reliable and flow-controlled delivery of data using IP.
User Datagram Protocol	UDP	A transport protocol that can be considered a “severely stripped-down” version of TCP. It is used to send data in a simple way between application processes, without the many reliability and flow management features of TCP, but often with greater efficiency.

Application Layer (OSI Layer 5/6/7) Protocols

As discussed in the topic on the [TCP/IP model](#), in TCP/IP the single application layer covers the equivalent of OSI layers 5, 6 and 7. The application protocols covered in this Guide are shown in [Table 24](#).

Table 24: TCP/IP Protocols: Application Layer (OSI Layer 5/6/7) (Page 1 of 2)

Protocol Name	Protocol Abbr.	Description
Domain Name System	DNS	Provides the ability to refer to IP devices using names instead of just numerical IP addresses. Allows machines to resolve these names into their corresponding IP addresses.
Network File System	NFS	Allows files to be shared seamlessly across TCP/IP networks.
Bootstrap Protocol	BOOTP	Developed to address some of the issues with RARP and used in a similar manner: to allow the configuration of a TCP/IP device at startup. Generally superseded by DHCP.
Dynamic Host Configuration Protocol	DHCP	A complete protocol for configuring TCP/IP devices and managing IP addresses. The successor to RARP and BOOTP, it includes numerous features and capabilities.
Simple Network Management Protocol	SNMP	A full-featured protocol for remote management of networks and devices.
Remote Monitoring	RMON	A diagnostic “protocol” (really a part of SNMP) used for remote monitoring of network devices.
File Transfer Protocol, Trivial File Transfer Protocol	FTP, TFTP	Protocols designed to permit the transfer of all types of files from one device to another.

Table 24: TCP/IP Protocols: Application Layer (OSI Layer 5/6/7) (Page 2 of 2)

Protocol Name	Protocol Abbr.	Description
RFC 822, Multipurpose Internet Mail Extensions, Simple Mail Transfer Protocol, Post Office Protocol, Internet Message Access Protocol	RFC 822, MIME, SMTP, POP, IMAP	Protocols that define the formatting, delivery and storage of electronic mail messages on TCP/IP networks.
Network News Transfer Protocol	NNTP	Enables the operation of the Usenet online community by transferring Usenet news messages between hosts.
Hypertext Transfer Protocol	HTTP	Transfers hypertext documents between hosts; implements the World Wide Web.
Gopher Protocol	Gopher	An older document retrieval protocol, now largely replaced by the World Wide Web.
Telnet Protocol	Telnet	Allows a user on one machine to establish a remote terminal session on another.
Berkeley "r" Commands	—	Permit commands and operations on one machine to be performed on another.
Internet Relay Chat	IRC	Allows real-time chat between TCP/IP users.
Administration and Troubleshooting Utilities and Protocols	—	A collection of software tools that allows administrators to manage, configure and troubleshoot TCP/IP internetworks.



TCP/IP Lower-Layer (Interface, Internet and Transport) Protocols (OSI Layers 2, 3 and 4)

The TCP/IP protocol suite is largely defined in terms of the protocols that constitute it; several dozen are covered in this Guide. Most of the critical protocols of the suite function at the **lower layers** of the [OSI Reference Model](#): layers 2, 3 and 4, which correspond to the network interface, internet and transport layers in the [TCP/IP model architecture](#). Included here are the all-important Internet Protocol (IP) at layer 3 and Transmission Control Protocol (TCP) at layer 4, which combine to give TCP/IP its name.

Due to the importance of these and other TCP/IP protocols at the lower layers, this is the largest chapter of The TCP/IP Guide. It contains four subsections. The first describes the two TCP/IP protocols that reside at the network interface layer, layer 2 of the OSI model: PPP and SLIP. The second describes a couple of “special” protocols that reside architecturally between layers 2 and 3: ARP and RARP. The third covers the TCP/IP internet layer (OSI network layer, layer 3), including IP and several other related and support protocol. The fourth describes the TCP/IP transport layer protocols TCP and UDP.



Background Information: [The high-level section on the TCP/IP protocol suite](#) describes it in general terms and lays out its architecture and key protocols. If you have not already read through it, I strongly recommend that you consider doing so before proceeding here.

TCP/IP Network Interface Layer (OSI Data Link Layer) Protocols

The lowest layer of the OSI Reference Model is the physical layer, which is responsible for the "nitty gritty" details of transmitting information from one place to another on a network. The layer just above the physical layer is the *data link layer*, called the *network interface layer* or just the *link layer* in the [TCP/IP architectural model](#). Its primary job is to implement networks at the local level, and to interface between the hardware-oriented physical layer, and the more abstract, software-oriented functions of the network layer and those above it.

In this section I provide a description of the two protocols that reside at the data link or network interface layer in the TCP/IP protocol suite. These are the Serial Line Internet Protocol (SLIP) and the Point-to-Point Protocol (PPP). They are both discussed in a single subsection below this one. (The reason why this section contains only one subsection is that the TCP/IP Guide is part of a larger networking reference that contains coverage for many more technologies and protocols at this layer.)

TCP/IP Serial Line Internet Protocol (SLIP) and Point-to-Point Protocol (PPP)

The TCP/IP protocol suite is structured around the [Internet Protocol \(IP\)](#). IP operates at layer three of the [OSI Reference Model](#), and assumes that it will be layered on top of an existing layer two technology. However, certain types of connections exist that do not include a layer two protocol over which IP can run. To enable TCP/IP to operate on these kinds of links, two special TCP/IP data link layer protocols have been created.

In this section I describe the protocols used specifically to implement data link layer connectivity for TCP/IP internetworks. I begin with a brief overview of the two protocols used to connect devices at layer two and how they fit into the [TCP/IP protocol suite](#) as a whole. I then have a single topic that describes the operation of the rather simple Serial Line Internet Protocol (SLIP), and a comprehensive section on the much more capable Point-to-Point Protocol (PPP).



Background Information: I want to emphasize again that IP is really the foundation of the TCP/IP protocol suite, even though SLIP and PPP are at a lower architectural layer. For this reason, I strongly recommend at least a basic understanding of the Internet Protocol before proceeding with this section. If you are going to read about both IP and SLIP/PPP, [I recommend reading about IP first](#).

SLIP and PPP Overview and Role In TCP/IP

The [TCP/IP protocol suite](#) was generally designed to provide implementation of the networking stack from the network layer (layer three) and above. The core protocols of TCP/IP operate at layers three and four of the OSI model, corresponding to the Internet layer and Host-to-Host Transport layer of the [TCP/IP architectural model](#). Other support protocols are defined at these two layers, and many application protocols run there too, as well as at the upper layers of the protocol stack.

However, the TCP/IP architectural model also defines the Network Interface layer, which corresponds to the data link layer (layer two) in the OSI scheme. In most classical networks, TCP/IP doesn't define any protocols operating at this layer. TCP/IP assumes that layer two functionality is provided by a WAN or LAN technology like Ethernet, Token Ring, or IEEE 802.11. These technologies are responsible for the classical layer two functions: physical layer addressing, media access control, and especially, layer two framing of datagrams received from layer three.



Note: I'm ignoring the protocols [ARP](#) and [RARP](#) for now, since they fall into a “gray area”, which I discuss in [the section that covers them](#).

Why TCP/IP Needs Network Interface Layer Protocols

There's a problem with the assumption that IP can run on top of an existing layer two protocol: sometimes there isn't one. There are certain technologies that establish only a basic, low-level connection at the physical layer. The most common example of this is a simple serial connection established between two devices. Years ago, it was fairly common for two computers to just be connected using serial ports instead of a full-fledged LAN protocol. Today, we see this much less, but there's another type of serial connection that is *very* popular: serial dial-up networking. When you use a modem to connect to a modem at your Internet Service Provider, the modems negotiate a connection that architecturally exists only at the physical layer.

Since the Internet Protocol assumes certain services will be provided at layer two, there is no way to make it operate directly over a serial line or other physical layer connection. The most important layer two function that is required at a minimum is some mechanism for framing the IP datagram for transmission—that is, providing the necessary data packaging to let datagrams be transmitted over the physical layer network. Without this, IP datagrams cannot be sent over the link.

TCP/IP Network Interface Layer Protocols: SLIP and PPP

We need something to “fill the gap” between IP at layer three and the physical connection at layer one. To this end, a pair of special protocols have been defined that operate at layer two and provide the services that IP requires to function. These are:

-
- **Serial Line Internet Protocol (SLIP):** A very simple layer two protocol that provides only basic framing for IP.
 - **Point-to-Point Protocol (PPP):** A more complex, full-featured data link layer protocol that provides framing as well as many additional features that improve security and performance.

Comparing SLIP and PPP

Both SLIP and PPP are designed for connections that go between just two devices; thus the name “Point-to-Point” Protocol for PPP. They are used in point-to-point LAN or WAN connections, the simplest type. Since there are only two devices, A and B, communication is straight-forward: A sends to B and B sends to A. Since they only deal with simple two-device connections, they do not have to worry about complexities like media access control, or collisions, or unique addressing schemes, the way technologies like Ethernet must. As mentioned earlier, the primary focus of these protocols is providing framing services to layer three, as well as extra features as needed.

Why have two protocols? They both get the job done; the difference is in how they do it. SLIP is extremely simple and easy to implement but lacks the features of PPP, like authentication, compression, error detection and more. PPP is full-featured but much more complicated.

To draw an analogy, SLIP is a mostly-sturdy, ten-year old compact sedan, while PPP is a shiny new luxury SUV. Both will get you from here to Grandma's house, but the SUV is going to be safer, more comfortable and better able to deal with problems that might crop up on the road. If they cost the same to buy and operate, you'd probably choose the SUV. Both SLIP and PPP cost about the same, and unlike an SUV, PPP causes no air pollution and doesn't guzzle gas. For this reason, PPP is the choice of most serial line connections today, and has all but replaced SLIP.



Key Concept: *SLIP* and *PPP* provide layer two connectivity for TCP/IP implementations that run directly over a physical layer link without a layer two technology. SLIP is simple and was more commonly used years ago, but today PPP is favored due to its many features and capabilities.

Are SLIP and PPP “Really” Part of TCP/IP?

Incidentally, I should mention that there are some people who don't even consider SLIP and PPP to be part of the “true” TCP/IP protocol suite. They argue that TCP/IP really is defined at layers three and up on the OSI model, and IP itself is the basis of TCP/IP at layer three. Thus, SLIP and PPP are just “extra” protocols that can be used under TCP/IP. To support their argument they point to the fact that PPP can be used for protocols other than IP (which is true). For its part, SLIP is so simple it could carry any layer-three protocol, but I don't believe it has been implemented for network layer protocols other than IP.

Frankly, I consider these to be “how many angels fit on the head of a pin” type arguments. As far as I am concerned, SLIP and PPP are part of TCP/IP because they were originally designed for the specific purpose of letting TCP/IP run on layer one links. They were defined using the normal Internet RFC process as well. Regardless, whether they are part of TCP/IP or not, they are used by millions of people every day to enable TCP/IP networks to operate, and thus are deserving of a place in this Guide.



Serial Line Internet Protocol (SLIP)

The need for a data link layer protocol to let IP operate over serial links was identified very early on in the development of TCP/IP. Engineers working on the Internet Protocol needed a way to send IP datagrams over serial connections linking computers together. To solve the problem they created a very simple protocol that would frame IP datagrams for transmission across the serial line. This protocol is called the *Serial Line Internet Protocol*, or *SLIP* for short.

SLIP Overview and History

SLIP is different from most TCP/IP protocols in that it has never been defined as a formalized standard. It was created informally in the early 1980s and its use spread as a **de facto standard** before it was ever described in an RFC document. Even when it was eventually published, in 1988, the decision was specifically made that SLIP would **not** be designated an official Internet standard. The authors of the paper that describes it, RFC 1055, made sure nobody would miss this point, by naming it *A Nonstandard For Transmission Of IP Datagrams Over Serial Lines: SLIP*.



On The Web: This is but one of several places where the IETF engineers let their sense of humor shine through. For another interesting example, see [RFC 1313](#). ☺

Why was SLIP designated as a “nonstandard” instead of a standard? Well, it was developed as a very rudimentary “stopgap” measure to provide layer two framing when needed. It's so simple that there really isn't much to standardize. Also, the protocol has so many deficiencies that the IETF apparently didn't want it given the status of a formalized standard. RFC 1055 makes specific mention of the problems with SLIP (which we'll see below) and the fact that work was already underway at that time to define a more capable successor to SLIP ([PPP](#)).

How simple is SLIP? So simple that it is one of the very few technologies in this Guide that I can describe almost completely without complaining that it's complicated, or resorting to telling you to “see the defining document for details”. SLIP performs only one function: framing of data for transmission. It does nothing else.



Key Concept: SLIP provides a *layer two framing service* for IP datagrams—and no other features or capabilities.

SLIP Basic Data Framing Method and General Operation

Here's how SLIP framing works. An IP datagram is passed down to SLIP, which breaks it into bytes and sends them one at a time over the link. After the last byte of the datagram, a special byte value is sent that tells the receiving device that the datagram has ended. This is called the SLIP *END character*, and has a byte value of 192 decimal (C0 hexadecimal, 11000000 binary). And that's basically it: take the whole datagram, send it one byte at a time, and then send the byte 192 to delimit the end of the datagram.

A minor enhancement to this basic operation is to **precede** the datagram by an *END* character as well. The benefit of this is that it clearly separates the start of the datagram from anything that preceded it. To see why this might be needed, suppose at a particular time we have only one datagram to send, datagram #1. So, we send #1, and then send the *END* character to delimit it. Now, suppose there is a pause before the next datagram shows up. During that time we aren't transmitting, but if there is line noise, the other device might pick up spurious bytes here and there. If we later receive datagram #2 and just start sending it, the receiving device might think the noise bytes were part of datagram #2.

Starting datagram #2 off with an *END* character tells the recipient that anything received between this *END* character and the previous one is a separate datagram. If that's just noise, then this "noise datagram" is just gibberish that will be rejected at the IP layer. Meanwhile, it doesn't corrupt the real datagram we wish to send. If no noise occurred on the line between datagrams then the recipient will just see the *END* at the start of datagram #2 right after the one at the end of #1, and will ignore the "null datagram" between the two.

Escaping Special Characters

There is only one other issue SLIP deals with. If the *END* character is 192 decimal, what happens if the byte value 192 appears in the datagram itself? Transmitting it "as is" would fool the recipient into thinking the datagram ended prematurely. To avoid this, a special *Escape character (ESC)* is defined, which has a decimal value of 219 (DB in hex, 11011011 in binary). The term "escape" means that this symbol conveys the meaning "this byte and the next one have a special meaning". When a value of 192 appears in the datagram, the sending device replaces it by the ESC character (219 decimal) followed by the value 220 decimal. Thus, a single "192" becomes "219 220" (or "DB DC" in hexadecimal). The recipient translates back from "219 220" to "192".



Note: The SLIP *ESC* character is not the same as the ASCII *ESC* character. They both perform an "escaping" operation but are otherwise unrelated.

This leaves one final problem: what happens if the **escape character itself** is in the original datagram? That is, what if there's a byte value of 219 in the IP datagram to be sent? This is handled by a similar substitution: instead of "219" we put "219 221".

So in summary, this is basically everything SLIP does:

- ☉ Break an IP datagram into bytes.
- ☉ Send the *END* character (value “192”) after the last byte of the datagram; in better implementations, send the *END* character before the first byte as well.
- ☉ If any byte to be sent in the datagram is “192”, replace it with “219 220”.
- ☉ If any byte to be sent is “219”, replace it with “219 221”.

Figure 22 shows an example of how SLIP works, including the escaping of special characters, using a mock IP datagram.

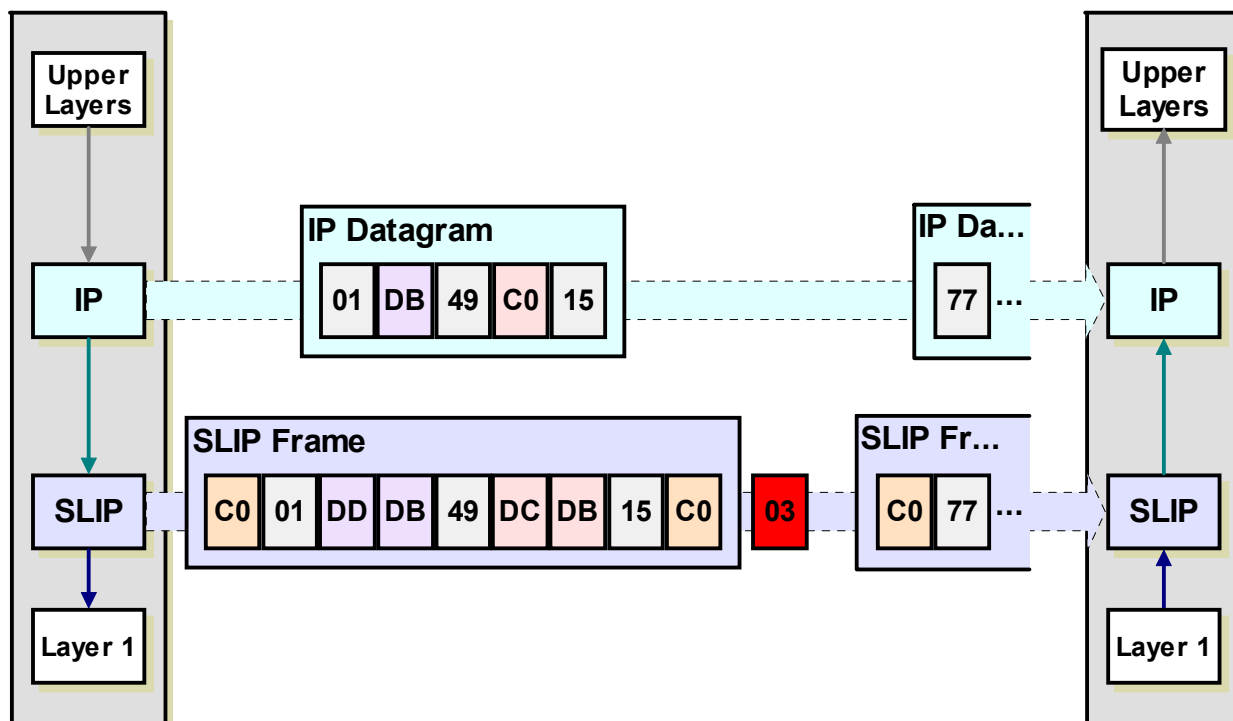

Figure 22: Operation of the Serial Line Internet Protocol (SLIP)

IP datagrams are passed down to the SLIP software at layer two (a simplified one with only five bytes is shown here). There, they are framed by surrounding them with *END* characters (hexadecimal value C0h, shown in orange). Special characters with hexadecimal values DBh and C0h are replaced by two-byte sequences. Note that the presence of the bracketing *END* characters forces the receiving device to see the noise byte (03h, in red) as a separate IP datagram, rather than part of either of the real ones. It will be rejected when passed up to the IP layer.

Problems and Limitations of SLIP

SLIP sounds great, right—nice and simple? Unfortunately, the cost of this simplicity is that SLIP just doesn't provide many of the features and capabilities we really need on modern serial links. Some of the most significant problems with SLIP include the fact that it is deficient in all of the following areas:

-
- ④ **Standardized Datagram Size Specification:** SLIP's maximum datagram size supported is not standardized and depends on the implementation. The usual default is 1006 bytes, which becomes the [maximum transmission unit \(MTU\)](#) for the link. If a different size is used this must be programmed into the IP layer.
 - ④ **Error Detection/Correction Mechanism:** SLIP doesn't provide any way of detecting or correcting errors in transmissions. While such protection is provided at higher layers through [IP header checksums](#) and other mechanisms, it is a job "traditionally" also done at layer two. The reason is that relying on those higher layers means that errors are only detected after an entire datagram has been sent and passed back up the stack at the recipient. Error correction can only come in the form of re-sending any datagrams that were corrupted. This is inefficient, especially considering that serial links are generally much slower than normal LAN links.
 - ④ **Control Messaging:** SLIP provides no way for the two devices to communicate control information between them to manage the link.
 - ④ **Type Identification:** Since SLIP includes no headers of its own, it is not possible to identify the protocol it is sending. While developed for IP, you can see that there is no reason other layer three protocols could not be sent using SLIP. However, without type identification there is no way to mix datagrams from two or more layer three protocols on the same link.
 - ④ **Address Discovery Method:** Addressing isn't needed at layer two due to the point-to-point nature of the connection—there are only two devices so the intended recipient of each message is obvious. However, devices do need some way of learning each other's IP addresses for routing at layer three. SLIP provides no method for this.
 - ④ **Support For Compression:** Compression would improve performance over serial lines that are, again, slow compared to other technologies. SLIP provides no compression features. Note, however, that modems usually do support compression at layer one, for serial connections that use them. There was also a variant on SLIP called *Compressed SLIP* or *CSLIP* that was created in the late 1980s, but it was not as widely deployed as regular SLIP.
 - ④ **Security Features:** SLIP provides no methods for authentication of connections or encryption of data, which means even the basics of security are not provided.

Sounds pretty bad, doesn't it? The many shortcomings of SLIP have led most implementations to move from SLIP over to the newer Point-to-Point Protocol (PPP), which is a much richer data link protocol for direct connections that resolves the problems listed above. SLIP is now outdated, and some even consider it a historical protocol. Despite that, SLIP is still used in many places. Simplicity is attractive, and computer people are famous for their inertia: if something is implemented and is working well, many will refuse to change unless they are forced to do so.



Point-to-Point Protocol (PPP)

Even as SLIP was being documented as a “nonstandard” in RFC 1055, work was underway for a newer protocol to provide full-featured IP transmission over direct links between pairs of devices. The result is the *Point-to-Point Protocol (PPP)*, which defines a complete method for robust data link connectivity between units using serial lines or other physical layers. It includes numerous capabilities and features, including error detection, compression, authentication, encryption and much more.

Even though PPP is called a “protocol”, and even though it is considered part of TCP/IP—depending on whom you ask—it is really more a protocol **suite** than a particular protocol. The operation of PPP is based on procedures defined in many individual protocols, as we will see in this section. Thus, PPP can be considered a “protocol suite within a protocol suite”. Alternately, its components can be viewed as “subprotocols” within PPP.

In this section I provide a comprehensive look at the operation of the Point-to-Point Protocol, in four subsections. The first describes the fundamentals of PPP, including its history, standards and an overview of its general operation. The second explains the “core” protocols that are responsible for setting up PPP links and basic operation. The third covers the protocols used to implement various special features in PPP, such as compression and encryption. The last subsection provides detailed information on the various frame formats used by PPP protocols.



Note: The component protocols of PPP are normally just called “protocols” and not “subprotocols”. This is confusing, so watch out for it in networking literature. I try to be consistent in this section in referring to PPP as a suite, but remember that it really is often just collectively called a “protocol”.



Note: As we will see in this section, PPP can be used to carry the frames of many protocols operating at layers three and above. It is, however, best known for its use with IP, and that is the assumption for the descriptions in this section, unless otherwise specified.



Related Information: PPP is related to the High-Level Data Link Control (HDLC) protocol, which is in turn part of the Synchronous Data Link Control (SDLC) family of protocols. I have avoided reliance on the SDLC protocols in explaining PPP since PPP is important and widely used enough that I think it warrants independent description.

PPP Fundamentals and Operation

The problem with the Serial Line Internet Protocol was that it was too simple and didn't include enough features. As the saying goes, “be careful what you wish for”, especially when the complaint is too much *simplicity*. ☺ The Point-to-Point Protocol (PPP) corrects the lack of features in SLIP, but you could figure out, without really trying, what the cost is: significantly more complexity. Where the operation of SLIP can be explained in a few paragraphs, PPP is much more involved, including a number of specific processes that need to be explained.

Before discussing the individual protocols that comprise PPP, I want to take a high-level look at the protocol suite. I start with an overview, history and discussion of the benefits of PPP. I provide a high-level breakdown of the main components of the PPP suite, and a general description of how PPP operates. I then describe the steps involved in setting up and configuring a link, and the phases a PPP link passes through during its “lifetime”. Finally, I categorize and list the standards that define different aspects of PPP's functionality.



Note: I describe the operation of PPP before the standards that define it, which is different than the order used in most other sections in this Guide. I felt that in this case, the groupings used to list the standards would make more sense coming after the description of the PPP suite components and its overall operation.

PPP Overview, History and Benefits

Albert Einstein is credited with the following quote: “Everything should be made as simple as possible — but no simpler”. The Serial Line Internet Protocol (SLIP) is a good example of this maxim. It provides basic layer two framing for IP, but it is just *too* simple for many uses. Since all it does is frame the end of each datagram, it doesn't provide many of the features that we really need for reliable, secure and high-performance operation over serial links. This is especially true today when most serial connections are not short LAN cables but dial-up WAN connections over relatively long distances.

PPP Development and Standardization

SLIP was basically a “hack” to fill a specific need: bridging the gap between IP at layer three and a serial link at layer one. It “gets the job done” but doesn't provide any of the features we really want in a robust protocol for direct links between devices. PPP was developed to be a complete protocol suite that would enable fully-functional layer two connectivity to support not just IP but the transmission of other network layer protocols as well.

The history of PPP goes back to the late 1980s, when SLIP was the de facto standard for serial IP implementations. The first formal IETF document related to PPP was RFC 1134, published in 1989. This RFC is not the standard itself but a proposal for what would eventually be defined as the first main PPP standard, RFC 1171, in 1990. This early

document has been revised several times and several other documents added that define the various protocols that comprise the entire PPP suite. [PPP standards are described later in this section.](#)

The IETF is always smart about not reinventing the wheel. Rather than try to develop PPP from scratch, the decision was made to base it on the ISO High-Level Data Link Control (HDLC) protocol, which was initially developed by IBM. HDLC is a derivative of the Synchronous Data Link Control (SDLC) protocol. PPP's developers adapted its framing structure and some of its general operation from the HDLC protocol.

PPP General Function and Architecture

PPP is a [connection-oriented protocol](#) that enables layer two links over a variety of different physical layer connections. It is supported on both synchronous and asynchronous lines, and can operate in half-duplex or full-duplex mode. It was designed to carry IP traffic but is general enough to allow any type of network layer datagram to be sent over a PPP connection. As its name implies, it is for point-to-point connections between exactly two devices, and assumes that frames are sent and received in the same order.

PPP fits into the *Network Interface* layer (Link Layer) in the TCP/IP model, as shown in [Figure 23](#). The operation of PPP follows a specific sequence described in the [general operation topic](#), including a multi-step link establishment phase that may include optional authentication.

PPP Advantages and Benefits

A list of PPP's strengths reads very much like a list of SLIP's weaknesses, which I explained in detail in [the topic on SLIP](#). Some of the specific benefits of PPP compared to SLIP include:

- ① A more comprehensive framing mechanism, compared to the single *END* character in SLIP.
- ① Specification of the encapsulated protocol, to allow multiple layer three protocols to be multiplexed on a single link.
- ① Error detection for each transmitted frame through the use of a CRC code in each frame header.
- ① A robust mechanism for negotiating link parameters, including the maximum frame size permitted.
- ① A method for testing links before datagram transmission takes place, and monitoring link quality.
- ① Support for authentication of the connection using multiple authentication protocols.
- ① Support for additional optional features, including compression, encryption and link aggregation (allowing two devices to use multiple physical links as if they were a single, higher-performance link).

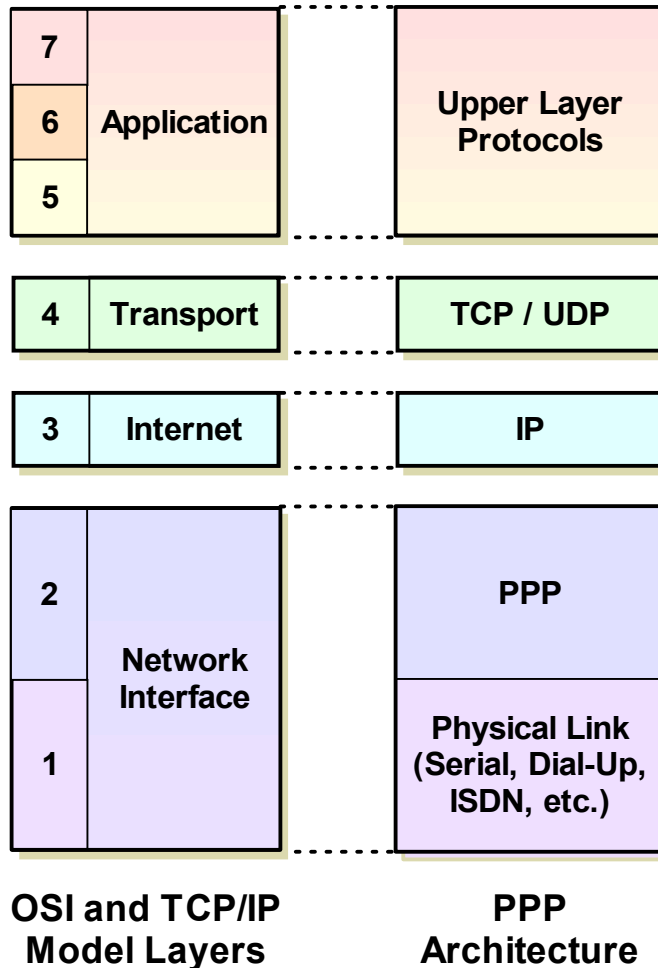

Figure 23: PPP Location in TCP/IP Architecture

PPP acts as the interface between the Internet Protocol and a physical link such as a serial line or dial-up networking connection. This corresponds to layer two in the OSI Reference Model.

The proliferation of serial links, especially for dial-up Internet access, has led to widespread use of PPP. It is now one of the most popular layer two WAN technologies in the networking world, and has replaced SLIP as the standard for serial connections on all but legacy implementations. While most often associated with dial-up modem use, PPP can run across any similar type of physical layer link. For example, it is often used to provide layer two functionality on ISDN B channels.



Key Concept: PPP is a complete link layer protocol suite for devices using TCP/IP, which provides framing, encapsulation, authentication, quality monitoring and other features to enable robust operation of TCP/IP over a variety of physical layer connections.

PPP's Extensibility

A key advantage of PPP is that it is an **extensible** protocol suite. Over the years new protocols have been added to the suite, to provide additional features or capabilities. For example, PPP is designed not to use just a single authentication protocol, but to allow a choice of which protocol is used for this purpose.

PPP's success has even led to the development of derivative protocols like PPP over Ethernet (PPPoE) and PPP over ATM (PPPoA). These actually layer PPP over existing data link layer technologies, which shows you how valued PPP's features are—even when a layer two technology is already in use, applying PPP on top provides authentication and management benefits for services like DSL.

PPP Components and General Operation

PPP stands for the Point-to-Point **Protocol**, but even the standard that defines PPP immediately starts describing protocols that comprise it, which is why I consider it a protocol suite. At the highest level, the functions of PPP can be broken down into several components. Each of these encompasses a general class of PPP functionality, and is represented by either one protocol in the suite or a set of protocols.

Main PPP Components

The PPP standard itself describes three “main” components of PPP:

- ☉ **PPP Encapsulation Method:** The primary job of PPP is to take higher-layer messages such as IP datagrams and encapsulate them for transmission over the underlying physical layer link. To this end, PPP defines a special frame format for encapsulating data for transmission, based on the framing used in the HDLC protocol. The PPP frame has been specially designed to be small in size and contain only simple fields, to maximize bandwidth efficiency and speed in processing.
- ☉ **Link Control Protocol (LCP):** The PPP [Link Control Protocol \(LCP\)](#) is responsible for setting up, maintaining and terminating the link between devices. It is a flexible, extensible protocol that allows many configuration parameters to be exchanged to ensure that both devices agree on how the link will be used.
- ☉ **Network Control Protocols (NCPs):** PPP supports the encapsulation of many different layer three datagram types. Some of these require additional setup before the link can be activated. After the general link setup is completed with LCP, control is passed to the PPP [Network Control Protocol \(NCP\)](#) specific to the layer three protocol being carried on the PPP link. For example, when IP is carried over PPP the NCP used is the PPP Internet Protocol Control Protocol (IPCP). Other NCPs are defined for supporting the IPX protocol, the NetBIOS Frames (NBF) protocol, and so forth.

The PPP encapsulation method and LCP are defined in the main PPP standard and some support standards; the NCPs are described in separate standard documents, one per NCP.

Additional PPP Functional Groups

While the three components above do constitute much of the total package of PPP, I would add to the list of components in the standard two additional functional groups. These represent some of the many extra protocols that have been added over time to the suite to support or enhance the basic operation of PPP:

- ④ **LCP Support Protocols:** Several protocols are included in the PPP suite that are used during the link negotiation process, either to manage it or to configure options. Examples include the [authentication protocols CHAP and PAP](#), which are used by LCP during the optional authentication phase.
- ④ **LCP Optional Feature Protocols:** A number of protocols have been added to the basic PPP suite over the years to enhance its operation after a link has been set up and datagrams are being passed between devices. For example, the [PPP Compression Control Protocol \(CCP\)](#) allows compression of PPP data, the [PPP Encryption Control Protocol \(ECP\)](#) enables datagrams to be encrypted for security, and the [PPP Multilink Protocol \(PPP MP\)](#) allows a single PPP link to be operated over multiple physical links. The use of these features often also requires additional setup during link negotiation, so several define extensions (such as extra configuration options) that are negotiated as part of LCP.

Each of these additional protocols is generally defined by a different standards document. You can find a list of some of these in the topic on PPP standards.

PPP General Operation

The fact that the PPP suite includes literally dozens of protocols often makes it seem like it must be a really complex technology. In fact, the general operation of PPP is really quite straight-forward. The existence of all those PPP protocols allows PPP to be flexible and extensible, supporting many higher layer datagram types and various features.

The bottom line, however, is that PPP operation involves just three basic steps. Beginning in a state where there is no PPP link between the devices, these are the operations that occur in PPP (also illustrated in [Figure 24](#)):

1. **Link Setup and Configuration:** Before the two devices can exchange information, they must make contact and set up a link between them. During link setup, all the parameters needed to manage the operation of the link are agreed upon by the two devices. The LCP begins this process, and invokes the help of support protocols as they are needed, for options like authentication. After the link is set up in general terms, the appropriate NCP is called for whatever layer three technology is being carried on the link to complete link setup.
2. **Link Operation:** The devices on the link use it to send datagrams. Each device transmits by taking layer three datagrams, encapsulating them and sending them down to layer one to be transmitted. Each device receives by taking PPP frames sent up from its own physical layer, stripping off the PPP header and passing the datagram up to layer three. Where appropriate, optional feature protocols are used here, such as CCP for compression.

-
3. **Link Termination:** When either device decides it no longer wants to communicate, it terminates the link. The link can of course be re-established if desired.

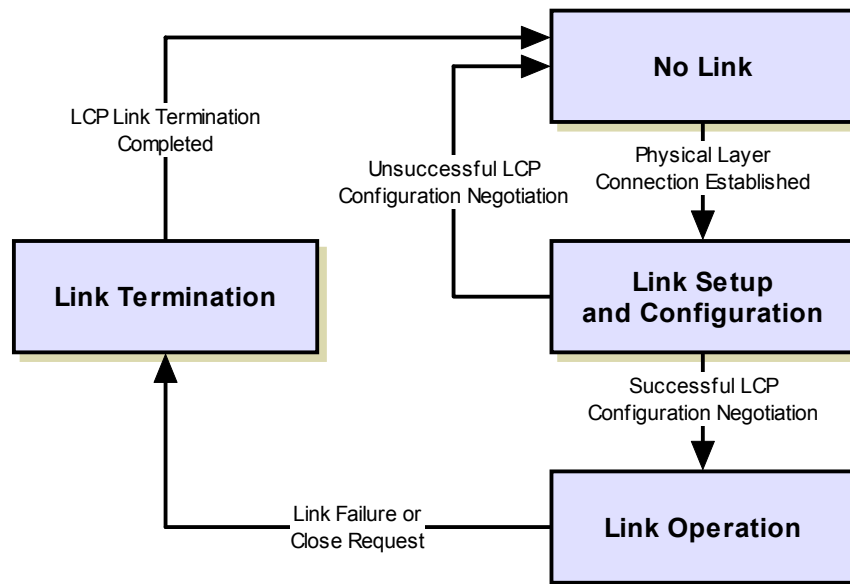

Figure 24: Overview of PPP Operation

In simplest terms, PPP consists of only three basic steps: link setup, link operation and link termination.

Link setup is by far the most complicated of these general steps, as it involves several substeps used to negotiate link parameters and options. The next topic describes the steps in link setup, and discusses the phases that a link passes through as it is set up, used, and eventually terminated.

PPP Link Setup and Phases

Before data can be exchanged on a PPP connection, a link must be set up between the two devices. As part of this setup task, a configuration process is undertaken whereby the two configure the link and agree on the parameters for how data should be passed between them. Only after this is completed can frames actually pass over the link.

The [PPP Link Configuration Protocol \(LCP\)](#) is generally in charge of setting up and maintaining PPP links. LCP may invoke an [authentication protocol](#) (PAP or CHAP) when PPP is configured to use authentication. After an LCP link has been opened, PPP invokes one or more [Network Control Protocols \(NCPs\)](#) for the layer three protocol being carried on the link. These perform any network-layer-specific configuration needed before the link can carry that particular network layer protocol.

The operation of a PPP link can be described as having a “life” of sort. Just as humans are born, grow, have an adult life span and then die, a PPP link is established, configured, used and eventually terminated. The process of setting up, using and closing a PPP link is described in the PPP standard as a series of *phases* or *states*. This is a type of *finite state machine (FSM)*, a tool used to explain the operation of protocols.



Background Information: The general concept behind an FSM is described in [the topic on the finite state machine of the Transmission Control Protocol \(TCP\)](#).

PPP Link Phases

When we talk about a PPP link overall, we are talking about the status of the LCP connection between the two devices; again, LCP governs the overall state of PPP as a whole. Once an LCP link has been opened, each of the NCPs used on the link can be opened or closed independently of the overall PPP (LCP) link. We'll see how this works momentarily.

An excellent way of understanding how PPP works is to look at these phases, and the process by which transition is made from one to the next during the lifetime of the link. For purposes of clarity, this description is based on an example where device *A* is a PC performing a dial-up networking connection to a remote host *B* (see [Figure 25](#)).

Link Dead Phase

By design, the PPP link always begins and ends in this phase. This phase represents the situation where there is no physical layer link established between the two devices. It remains here until the physical layer link is set up, at which point the link proceeds to the *Link Establishment* phase.

In our example, when *A* is first turned on, there is no physical layer connection (modem connection) between it and *B*. Once the connection is made, the link can proceed to phase 2. (Note that in a direct connection, such as a serial cable linking two PCs, the link may only stay in the *Link Dead* phase for a fraction of a second, until the physical layer connection is detected.)

Link Establishment Phase

The physical layer is now connected and LCP performs the basic setup of the link. Device *A* sends an LCP configuration request message to device *B* over the physical link, specifying the parameters it wishes to use. If Device *B* agrees, it replies with an acknowledgement. If *B* doesn't agree, it sends back a negative acknowledgment or rejection, telling device *A* what it won't accept. Device *A* can then try a different configuration request with new parameters that device *B* will hopefully accept. This process is described in more detail in [the topic covering LCP](#).

Hopefully, *A* and *B* will eventually come to agreement. If so, the status of the link is considered *LCP open*, and will proceed to the *Authentication* phase. If they cannot come to an agreement, the physical link is terminated, and we go back to the *Link Dead* phase.

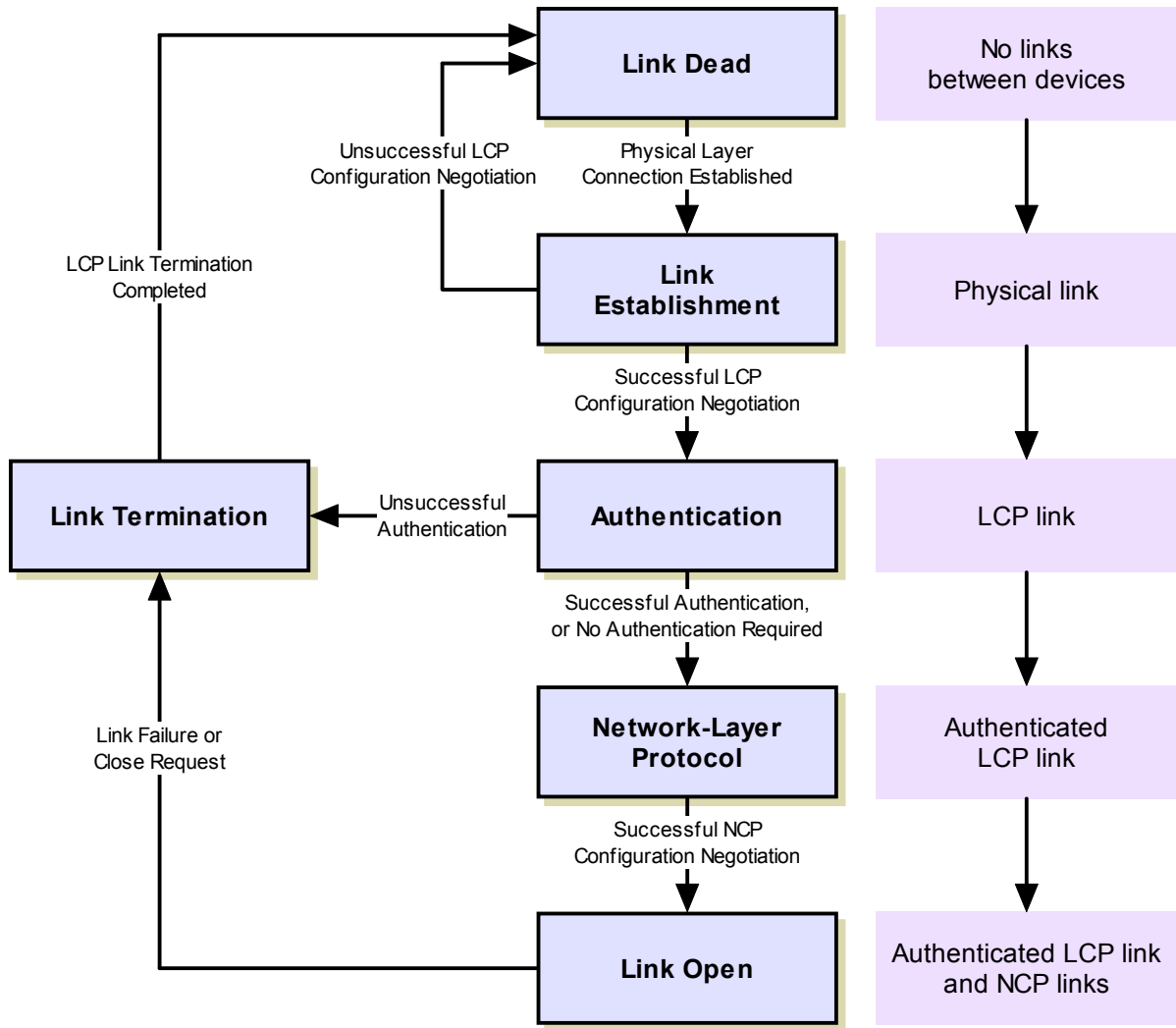

Figure 25: PPP Phases

The PPP connection between the two devices begins in the *Link Dead* state and proceeds through three intermediate phases until the link is fully opened, as shown in the flow chart on the left. It remains in the stable *Link Open* phase until terminated. The purple boxes show the corresponding change in the status of the PPP link as transitions are made between phases.

Authentication Phase

In many cases, a device may require authentication before it will permit connection of another device. (This is certainly usually the case when PPP is used for dial-up.) Authentication is not considered mandatory in PPP, however. When it is used, the appropriate authentication protocol (CHAP or PAP) is employed.

After successful authentication, the link proceeds to the *Network-Layer Protocol* phase. If authentication is not successful, the link fails and transitions to the *Link Termination* phase.

Network-Layer Protocol Phase

Once the basic link has been configured and authentication completed, the general setup of the LCP link is complete. Now, the specific configuration of the appropriate network layer protocol is performed by invoking the appropriate NCP, such as IPCP, IPXCP and so forth.

Each particular network layer protocol whose NCP is successfully configured is considered to be open on the LCP link. More than one NCP can be open on a particular PPP link, and each can be closed independently when it is no longer needed. After all necessary NCPs have been invoked, the link proceeds to the *Link Open* state, even if none were successfully opened.



Note: Some PPP features require the negotiation of additional options between the two devices just as the various network layer protocols do. These may perform their own link establishment process during the Network-Layer Protocol phase. For example, the PPP [Compression Control Protocol \(CCP\)](#) sets up data compression in this manner.

Link Open Phase

In this state, the LCP link and one or more NCP links are open and operational. Data can be passed for each NCP that has been successfully set up.

The link can be terminated at any time by either device for a variety of reasons. These may include user request (you hit the “disconnect” button when you want to log off your dial-up session); link quality problems (the modem hangs up on you due to line noise); or some other cause (you spend too much time in the bathroom and your ISP's idle timer logs you out ☺). When any of these occur the LCP link is broken and the link transitions to the *Link Termination* phase.

Link Termination Phase

The device terminating the link sends a special LCP termination frame, and the other device acknowledges it. The link then goes back to the *Link Dead* phase. In the case where the termination was by request and the physical layer connection is still active, the PPP implementation is supposed to specifically signal the physical layer to terminate the layer one connection.

Differentiating LCP and NCP Links

Remember that the basic link is established by LCP, and NCP links are set up within the LCP link. Closing an NCP link does not cause the LCP link to be closed. Even if all NCPs are closed, the LCP link remains open. (Of course, no data can be passed until an appropriate NCP link is re-established; a device is required to discard frames received containing

any layer three protocol that does not have an opened NCP.) To terminate a PPP connection, only the LCP link needs to be terminated in the *Link Termination* phase; the NCPs do not need to be explicitly closed.

PPP Link Setup and Phase Summary

A summary of PPP phases can be found in [Table 25](#). In the table, the *LCP Link Status* and *NCP Link Status* columns show the status of the link as the phase starts.

Table 25: PPP Phases

Phase/ State	Phase Summary	LCP Link Status Upon Entry To Phase	NCP Link Status Upon Entry To Phase	Transition Requirement	Transition To Phase
<i>Link Dead</i>	Default state; physical layer not connected.	Closed	Closed	Successful physical layer connection	<i>Link Establishment</i>
<i>Link Establishment</i>	Physical layer connected, basic configuration of link performed by LCP.	Closed	Closed	Successful negotiation	<i>Authentication</i>
				Unsuccessful negotiation	<i>Link Dead</i>
<i>Authentication</i>	Basic link is now opened, and optional authentication of device is performed.	Open	Closed	Successful authentication or no authentication required	<i>Network-Layer Protocol</i>
				Unsuccessful authentication	<i>Link Termination</i>
<i>Network-Layer Protocol</i>	One or more NCPs open an NCP link within the LCP link.	Open	Closed	All NCPs opened	<i>Link Open</i>
<i>Link Open</i>	Link is open and operating normally.	Open	Open	Link failure or close request	<i>Link Termination</i>
<i>Link Termination</i>	LCP link is shut down.	Open	Open		<i>Link Dead</i>

PPP Standards

PPP is not a single protocol but rather a suite of many. The basic architecture of PPP was also designed to allow it to be easily extended through the addition of protocols to the suite. For both of these reasons, it makes sense that PPP's operation is defined not in a single standard but in many different standards. Like all TCP/IP standards, the PPP protocols are described in a series of [RFCs](#). These are regularly updated as changes are needed to the different components of PPP, and as new technologies are added to it.

While it makes sense to have different parts of PPP covered in different standards, this does make it much harder to learn about how PPP works than if everything were in one specification. Worse, there aren't just a few PPP standards; there are literally *dozens* of RFCs that cover PPP's main operation, its various protocols and other issues related to it. You can find most of them by consulting a master list of RFCs and searching for the string "PPP", but this way you will find them in numerical (RFC number) order, which isn't very meaningful in terms of how the protocols are used. You also have to differentiate between ones that are current and those that have been obsoleted.

Below I have described the most important and/or interesting of the RFCs that are related to PPP. To make it easier to see what the RFCs are about, I have organized them into groups. These groups roughly correspond to the component groups I discussed in the general operation topic. Within each group the RFCs are listed in numerical order, which is also date order. Only the most recent RFC is listed, not earlier ones that were obsoleted (with the exception of RFC 1334; see the note below in that entry).

Despite the collective size of these tables, I haven't even come close to listing all the standards defined that relate to PPP. Incidentally, to keep it from being even larger (and more confusing) I didn't list the individual compression and encryption algorithms here; you can find them in the topics on [compression](#) and [encryption](#).

You can find more information on most of the protocols in the preceding table in the next two sections.

Base PPP Standards

[Table 26](#) shows the "main" documents that describe PPP in general terms. They cover the basic operation of PPP including the [PPP Link Control Protocol \(LCP\)](#) and encapsulation of datagrams.

Table 26: PPP Base Standards

RFC Number	Standard Name	Description
1570	<i><u>PPP LCP Extensions</u></i>	Defines two new features for LCP that allow devices to identify each other to the other device and also tell the other device how much time remains in the current session.
1661	<i><u>The Point-to-Point Protocol (PPP)</u></i>	Base standard for the Point-to-Point protocol. Describes PPP architecture, general operation (including the process of link establishment, maintenance and termination) and details of the LCP protocol.
1662	<i><u>PPP in HDLC-like Framing</u></i>	Defines the specific framing method for PPP frames, based on that used in HDLC. This standard can be considered a "companion" to the main PPP standard, RFC 1661.

LCP Support Protocols

These protocols, shown in [Table 27](#), support the basic operation of LCP. At this time the only protocols I put in this group are those that provide [authentication services](#) during link startup.

Table 27: PPP LCP Support Protocol Standards

RFC Number	Standard Name	Description
1334	<i><u>PPP Authentication Protocols</u></i>	Defines the two PPP authentication protocols: Password Authentication Protocol (PAP) and Challenge Handshake Authentication Protocol (CHAP). Note that RFC 1994 obsoletes RFC 1334, but does not discuss the PAP protocol. This basically tells you what the IETF thinks about PAP. © See the topic on PAP and CHAP for more on this.
1994	<i><u>PPP Challenge Handshake Authentication Protocol (CHAP)</u></i>	Updates the information about CHAP provided in RFC 1334.

Network Control Protocols (NCPs)

These are protocols that negotiate parameters specific to various layer three protocols carried over PPP. They are described in [Table 28](#).

Table 28: PPP Network Control Protocol Standards

RFC Number	Standard Name	Description
1332	<i><u>The PPP Internet Protocol Control Protocol (IPCP)</u></i>	The NCP for the Internet Protocol (IP).
1377	<i><u>The PPP OSI Network Layer Control Protocol (OSINLCP)</u></i>	The NCP for OSI protocol suite network layer protocols, such as CNLP, ES-IS, and IS-IS.
1378	<i><u>The PPP AppleTalk Control Protocol (ATCP)</u></i>	The NCP for the AppleTalk protocol.
1552	<i><u>The PPP Internetworking Packet Exchange Control Protocol (IPXCP)</u></i>	The NCP for the Novell Internetworking Packet Exchange (IPX) protocol.
2043	<i><u>The PPP SNA Control Protocol (SNACP)</u></i>	The NCP for IBM's Systems Network Architecture (SNA).
2097	<i><u>The PPP NetBIOS Frames Control Protocol (NBFCP)</u></i>	The NCP for NetBIOS Frames (NBF, also commonly called NetBEUI).
2472	<i><u>IP Version 6 over PPP</u></i>	Describes the NCP for IPv6: the IPv6 Control Protocol (IPv6CP).

Feature Protocols

These protocols define optional features used with PPP, such as compression and encryption ([Table 29](#)).

Table 29: PPP Feature Protocol Standards

RFC Number	Standard Name	Description
1962	<i><u>The PPP Compression Control Protocol (CCP)</u></i>	Defines a mechanism for compressing data sent over PPP links to improve performance. This standard describes how compression is negotiated between two devices on a PPP link. It is used in conjunction with several compression algorithms that actually do the compression of data.
1968	<i><u>The PPP Encryption Control Protocol (ECP)</u></i>	Defines a mechanism for encrypting data sent over PPP links to improve performance. This standard describes how encryption is negotiated between two devices. It is used with several encryption algorithms.
1989	<i><u>PPP Link Quality Monitoring</u></i>	Defines a protocol that lets PPP devices generate reports to each other about the quality of the link.
1990	<i><u>The PPP Multilink Protocol (MP)</u></i>	Defines a method for running PPP over a set of aggregated links, allowing two devices to use multiple low-bandwidth links as a single, high-bandwidth virtual link.
2125	<i><u>The PPP Bandwidth Allocation Protocol (BAP) / The PPP Bandwidth Allocation Control Protocol (BACP)</u></i>	Defines two support protocols that manage the allocation of bandwidth in links aggregated using the PPP Multilink Protocol (MP).

Applications and Miscellaneous

These protocols describe how PPP can be adapted to run over particular types of links, or that don't really fit into any of the other groups above. They are shown in [Table 30](#).

Table 30: PPP Application and Miscellaneous Standards (Page 1 of 2)

RFC Number	Standard Name	Description
1618	<i><u>PPP over ISDN</u></i>	Describes application particulars for running PPP over ISDN links.
1973	<i><u>PPP in Frame Relay</u></i>	Describes how PPP may be modified to run over Frame Relay at layer two.
2290	<i><u>Mobile-IPv4 Configuration Option for PPP IPCP</u></i>	Defines changes to the PPP Internet Protocol Control Protocol (IPCP) to support Mobile IP.
2364	<i><u>PPP Over AAL5</u></i>	Defines a method for sending PPP frames over AAL5 (ATM); commonly called PPPoA.

Table 30: PPP Application and Miscellaneous Standards (Page 2 of 2)

RFC Number	Standard Name	Description
2516	<u><i>A Method for Transmitting PPP Over Ethernet (PPPoE)</i></u>	Defines a technique for encapsulating PPP frames over Ethernet (PPPoE).
2615	<u><i>PPP over SONET/SDH</i></u>	Discusses how to encapsulate PPP frames over SONET/SDH links.



PPP Core Protocols: Link Control, Network Control and Authentication

The PPP protocol suite consists of several dozen protocols that cover various aspects of its operation. Of these, a few protocols can be considered the most important or “core” of the suite. It's not that the others are *not* important, mind you. But this small group is responsible for the basic operation of PPP. In particular, they work together to implement the relatively complex link negotiation process, which is a big part of what PPP is all about.

In this section I describe the protocols that are responsible for PPP link setup and basic operation. I begin with a description of the key Link Control Protocol (LCP). I then describe the different Network Control Protocols (NCPs) used to configure PPP for different layer three protocols. Finally, I discuss the two PPP authentication protocols, PAP and CHAP, used to provide authentication during link setup.



Related Information: The frame formats for these protocols are detailed in the separate [section on PPP frames and frame formats](#).

PPP Link Control Protocol (LCP)

Of all the different PPP suite protocols, the single most important protocol is the PPP *Link Control Protocol (LCP)*. LCP is the “boss” of PPP; it is responsible for its overall successful operation, and for “supervising” (in a way) the actions of other protocols.

PPP is about links, and LCP is about controlling those links. As I discussed in the PPP fundamentals section, the operation of a PPP link can be thought of as proceeding through various “life stages” just as a biological organism does. There are three main stages of “link life” and LCP plays a key role in each one:

- ☉ **Link Configuration:** The process of setting up and negotiating the parameters of a link.
- ☉ **Link Maintenance:** The process of managing an opened link.
- ☉ **Link Termination:** The process of closing an existing link when it is no longer needed (or when the underlying physical layer connection closes).

Each of these functions corresponds to one of the “[life phases](#)” of a PPP link. Link configuration is performed during the initial *Link Establishment* phase of a link; link maintenance occurs while the link is open, and of course, link termination happens in the *Link Termination* phase. [Figure 26](#) represents a summary of the LCP link, showing the different message exchanges performed by LCP during these different life phases of a PPP connection.

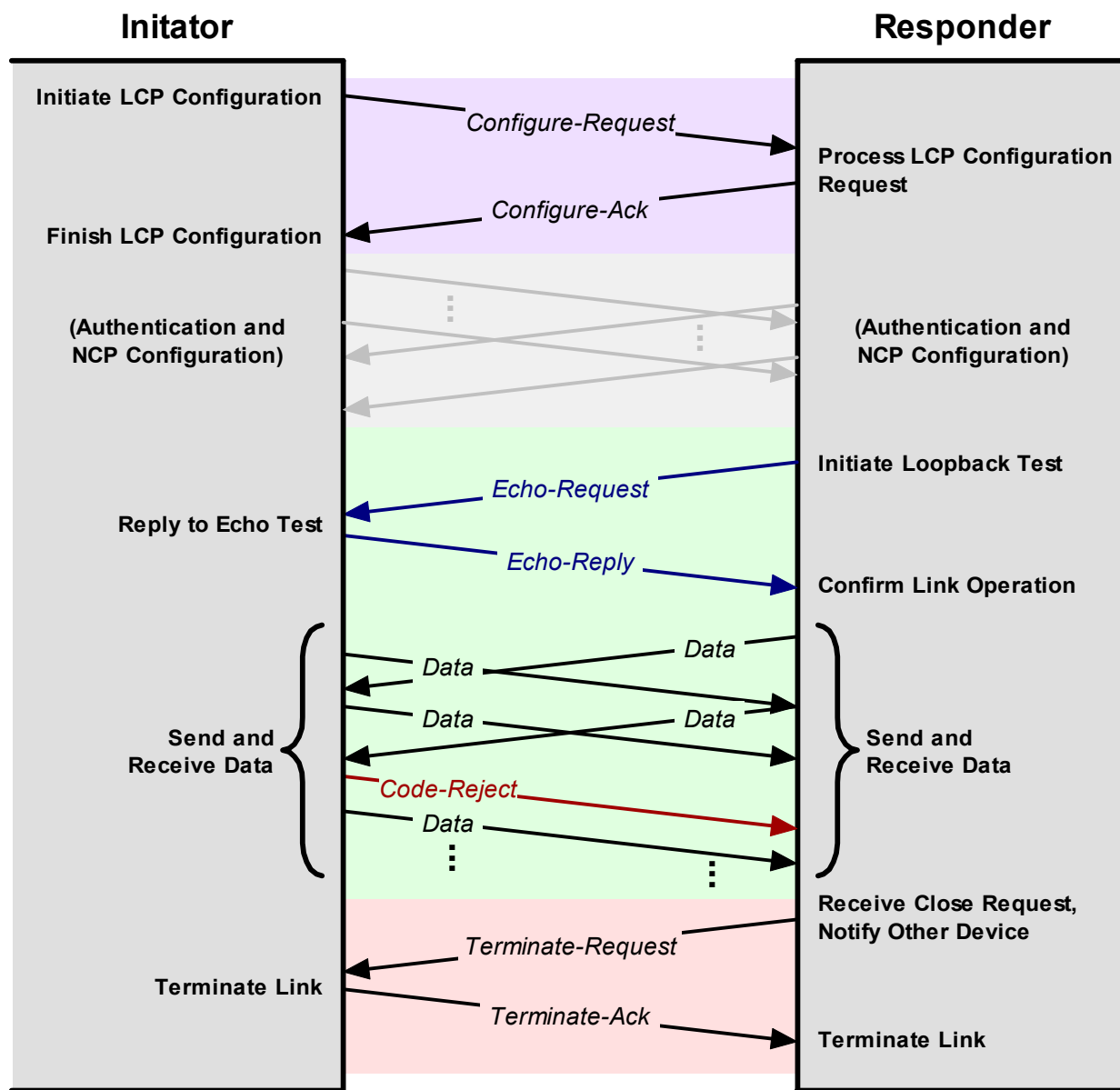

Figure 26: PPP Link Control Protocol (LCP) Message Exchanges

This diagram provides an overview of many of the message exchanges performed by LCP during different phases of a PPP connection. Link Configuration is here shown as a simple exchange of a *Configure-Request* and *Configure-Ack*. After subsequent exchanges using other PPP protocols to authenticate and configure one or more NCPs, the link enters the *Link Open* phase. In this example, an *Echo-Request* and *Echo-Reply* message are first used to test the link, followed by the sending and receiving of data by both devices. One *Data* message is shown being rejected due to an invalid *Code* field. Finally, the link is terminated using *Terminate-Request* and *Terminate-Ack* messages.

LCP Frames

Devices use LCP to control the PPP link by sending special LCP messages across the physical link between them. These messages are called both LCP packets and LCP frames; while the standard uses "packet", the term "frame" is preferred because layer two

messages are normally called frames. There are eleven different LCP frame types defined in the main PPP document, which are divided into three groups that correspond to the three link “life stages” above. Four LCP frame types are used for link configuration, five for maintenance and two for termination. The frame formats themselves are described in [the topic on LCP frames](#). Below I will discuss each of the three major functions of LCP and how the frames are used in each.



Key Concept: The *PPP Link Control Protocol (LCP)* is the most important protocol in the PPP suite. It is responsible for configuring, maintaining and terminating the overall PPP link. The two devices using PPP employ a set of LCP frames to conduct LCP operations.

LCP Link Configuration

Link configuration is arguably the most important job that LCP does in PPP. During the *Link Establishment* phase, LCP frames are exchanged that enable the two physically-connected devices to negotiate the conditions under which the link will operate. [Figure 27](#) shows the entire procedure, which we will now examine in detail.

The process starts with the initiating device (let's call it device *A*, yeah, isn't that original) creating a *Configure-Request* frame that contains a variable number of configuration options that it wants to see set up on the link. This is basically device *A*'s “wish list” for how it wants the link created.

The main PPP document (RFC 1661) defines a number of different configuration options that the initiator can specify in this request. Any one of these can be included and if so, filled in with the value corresponding to what device *A* wants for that option. If absent, this means device *A* is neither requesting nor specifying that option. The six options are:

- ☉ ***Maximum-Receive-Unit (MRU)***: Lets device *A* specify the maximum size datagram it wants the link to be able to carry.
- ☉ ***Authentication-Protocol***: Device *A* can indicate the type of authentication protocol it wishes to use (if any).
- ☉ ***Quality-Protocol***: If device *A* wants to enable quality monitoring on the link, what protocol to use (though there is only one currently defined: LQR).
- ☉ ***Magic-Number***: Used to detect looped back links or other anomalies in the connection.
- ☉ ***Protocol-Field-Compression***: Allows device *A* to specify that it wants to use “compressed” (8 bit) *Protocol* fields in PPP data frames instead of the normal 16 bit *Protocol* field. This provides a small but free savings (one byte) on each PPP frame. Note that this has nothing to do with the compression feature offered by CCP. See the PPP general frame format topic for more on this feature.
- ☉ ***Address-and-Control-Field-Compression (ACFC)***: The same as the option just above but used to compress the *Address* and *Control* fields, again for small bandwidth savings. Again, see [the PPP general frame format topic](#) for more.

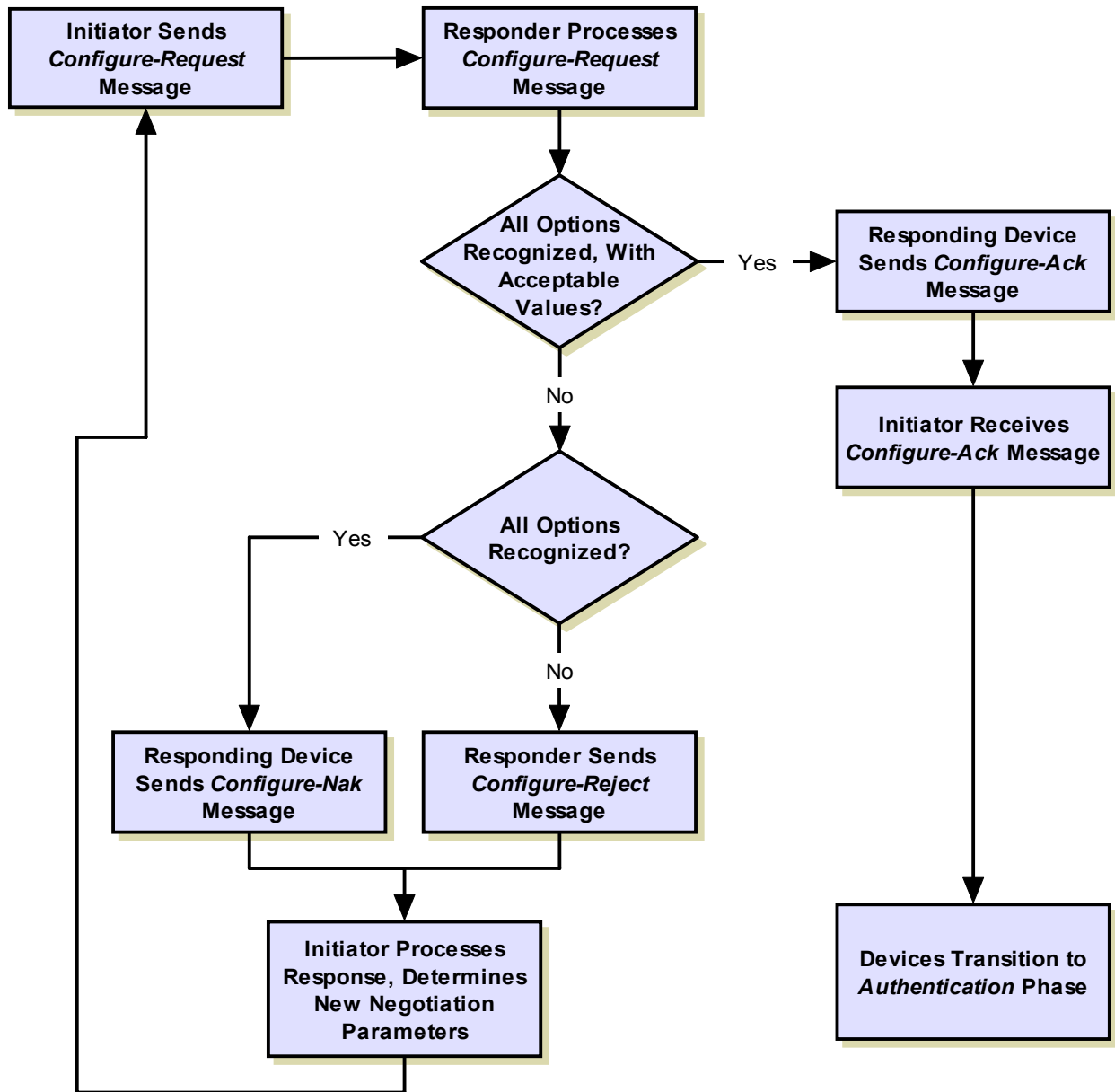

Figure 27: PPP LCP Link Configuration Process

This flowchart shows in more detail the negotiation process undertaken to configure the link by LCP. This process begins when the PPP link enters the *Link Establishment* phase. After successful configuration, the connection transitions to the *Authentication* phase.

Other options may also be added to this list by optional feature protocols. For example, [Multilink PPP](#) adds several options that must be negotiated during link setup.

The other device (let's call it say... device *B* ☺) receives the *Configure-Request* and processes it. It then has three choices of how to respond:

1. If every option in it is acceptable in every way, device *B* sends back a *Configure-Ack* (“acknowledge”). The negotiation is complete.

-
2. If all the options that device *A* sent are valid ones that device *B* recognizes and is capable of negotiating, but it doesn't accept the values device *A* sent, then device *B* returns a *Configure-Nak* (“negative acknowledge”) frame. This message includes a copy of each configuration option that *B* found unacceptable.
 3. If any of the options that *A* sent were either unrecognized by *B*, or represent ways of using the link that *B* considers not only unacceptable but not even subject to negotiation, it returns a *Configure-Reject* containing each of the objectionable options.

The difference between a *Configure-Nak* and a *Configure-Reject* is that the former is like device *B* saying “I don't accept your terms, but I'm willing to haggle”, while the latter is device *B* basically saying “No way Jose”. For example, if device *A* tries to request PAP as the authentication protocol but device *B* wants to use CHAP, it will send a *Configure-Nak*. If device *B* doesn't support authentication at all, it will send a *Configure-Reject*.



Note: Even after receiving a reject, device *A* can retry the negotiation with a new *Configure-Request*.

LCP Link Maintenance

Once the link has been negotiated, LCP passes control to the appropriate authentication and/or NCP protocols as discussed in [the PPP Link Setup and Phases topic](#). Eventually the link setup will complete and go into the open state. LCP messages can then be used by either device to manage or debug the link:

- ☉ **Code-Reject and Protocol-Reject:** These frame types are used to provide feedback when one device receives an invalid frame due to either an unrecognized LCP *Code* (LCP frame type) or a bad *Protocol* identifier.
- ☉ **Echo-Request, Echo-Reply and Discard-Request:** These frames can be used for testing the link.

LCP Link Termination

Finally, when the link is ready to be shut down, LCP terminates it. The device initiating the shutdown (which may not be the one that initiated the link in the first place) sends a *Terminate-Request* message. The other device replies back with a *Terminate-Ack*. A termination request indicates that the device sending it needs to close the link. Like a four-year-old who tells you he “needs to go now, **bad!**”, this is a request that cannot be denied. ☺

Other LCP Messages

The standard RFC 1570, *PPP LCP Extensions*, also defines two new LCP message types. The *Identification* message is used to allow a device to identify itself to its peer on the link. The *Time-Remaining* message lets one device tell the other how much time remains in the current session.

Relationship Between LCP and Other PPP Protocols

Note that many of the other protocols used in PPP are modeled after LCP. They use the same basic techniques for establishing protocol connections, and send and receive a subset of LCP message types. They also exchange configuration options in a similar manner. The next topic shows how the Network Control Protocols (NCPs) are based on LCP. You will see the same thing in looking at feature protocols such as CCP, ECP and others.

PPP Network Control Protocols (IPCP, IPXCP, NBFCP and others)

One of the reasons why PPP is such a powerful technology is that it is flexible and expandable. Even though it was originally created with the idea of carrying IP datagrams, PPP's designers recognized that it would be short-sighted to think so narrowly. PPP could easily carry data from many types of network layer protocols, and on some networks, it might even be advantageous to let it carry datagrams from different layer three protocols simultaneously.

Allowing PPP to support multiple network layer protocols would require it to have knowledge of each one's idiosyncrasies. If we used only LCP for link configuration, it would need to know all the unique requirements of each layer three protocol. This would also require that LCP be constantly updated as new layer three protocols were defined and as new parameters were defined for existing ones.

Instead of this inflexible design, PPP takes a “modular” approach to link establishment. LCP performs the basic link setup, and after (optional) authentication, invokes a *Network Control Protocol (NCP)* that is specific to each layer three protocol that is to be carried over the link. The NCP conducts a negotiation of any parameters that are unique to the particular network layer protocol. More than one NCP can be run for each LCP link; the process of how this is done and the relationship between the NCP links and LCP link can be seen in [the topic on PPP link setup and phases](#).

Each of the common network layer technologies has a PPP NCP defined for it in a separate RFC. These documents are usually named in this pattern: “The PPP <layer three protocol name> Control Protocol”. The most common ones are *The PPP Internet Protocol Control Protocol (IPCP)*, *The PPP Internetworking Packet Exchange Control Protocol (IPXCP)*, and *The PPP NetBIOS Frames Control Protocol (NBFCP)*. These are the NCPs for IP, IPX and NBF (also called NetBEUI), respectively. A separate NCP is also defined for [IP version 6](#), the *PPP IP Version 6 Control Protocol (IPv6CP)*.

Operation of PPP Network Control Protocols

Each NCP operates very much like a “lite” version of LCP, as you can see by examining [Figure 28](#) (and comparing it to [Figure 26](#), which shows the messaging for LCP). Like LCP, each NCP performs functions for link setup, maintenance and termination—only it deals with its particular type of NCP link and not the “overall” LCP link. Each NCP uses a subset of seven of the message types defined in LCP, and uses them in very much the same way as the message type of the same name is used in LCP:

-
- ☉ **Link Configuration:** The process of setting up and negotiating the parameters of the particular NCP link (once an LCP link is established) is accomplished using *Configure-Request*, *Configure-Ack*, *Configure-Nak* and *Configure-Reject* messages just as described in the LCP topic, except these ones are particular to the NCP. The configuration options are of course different; they are the network layer protocol parameters being negotiated.
 - ☉ **Link Maintenance:** *Code-Reject* messages can be sent to indicate invalid code values (NCP frame types).
 - ☉ **Link Termination:** An NCP link can be terminated using *Terminate-Request* and *Terminate-Ack*. (Remember that NCP links are set up within an LCP link; there can be more than one NCP link open, and closing NCP links doesn't terminate the LCP link. Also, NCP links do not need to be closed when an LCP link is terminated.)



Key Concept: After the primary PPP link is established using LCP, each network layer protocol to be carried over the link requires the establishment of the appropriate NCP link. The most important of these is the *PPP Internet Protocol Control Protocol (IPCP)*, which allows IP datagrams to be carried over PPP.

An Example NCP: The Internet Protocol Control Protocol (IPCP)

Let's look at the NCP for IP, IPCP. When PPP is set up to carry IP datagrams, IPCP is invoked in the *Network-Layer Protocol* phase (one of the [PPP phases](#)) to set up an IP NCP link between the two devices. The setup is carried out using the four “*Configure-*” messages. For IP, there are two configuration options that can be specified in an IPCP *Configure-Request*:

- ☉ **IP-Compression-Protocol:** Allows devices to negotiate the use of something called “Van Jacobson TCP/IP header compression”. This compresses the size of TCP and IP headers to save bandwidth. Thus, this is similar in concept to the *Protocol-Field-Compression* and *Address-and-Control-Field-Compression (ACFC)* options in LCP.
- ☉ **IP-Address:** Allows the device sending the *Configure-Request* to either specify an IP address it wants to use for routing IP over the PPP link, or to request that the other device supply it with one. This is most commonly used for dial-up networking links.

Again, the receiving device can send back an IPCP *Configure-Ack*, an IPCP *Configure-Nak*, or an IPCP *Configure-Reject*, just as they work in LCP. The other NCPs are similar, but use different configuration options. After configuration is complete, data can be sent for the layer three protocol corresponding to the NCP negotiated. This is indicated by using the appropriate value for the *Protocol* field in PPP data frames containing that layer three data.



Note: As an aside, the full expanded name of the NCP for IP is “The Point-to-Point Protocol Internet Protocol Control Protocol”. Three “protocols” in one name. That has to be some sort of a record. 😊

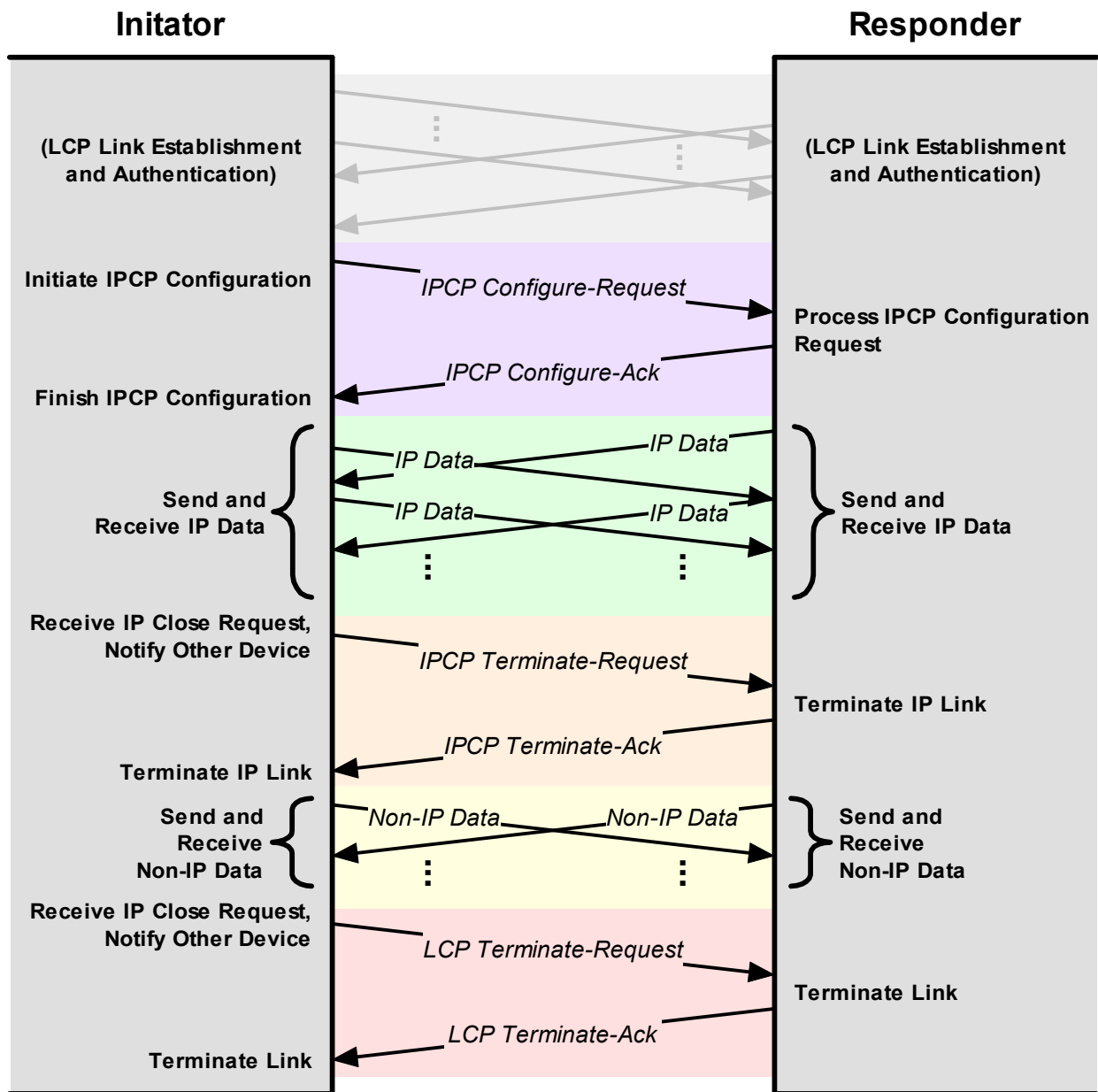

Figure 28: PPP IP Control Protocol (IPCP) Message Exchanges

The overall operation of the NCPs, such as IPCP, is very similar to that of LCP. After LCP configuration (including authentication) is complete, *IPCP Configure-Request* and *Configure-Ack* messages are used to establish an IPCP link. IP Data can then be sent over the link. If the IPCP connection is no longer needed it may be terminated, after which the LCP link remains open for other types of data to be transmitted. It is not necessary, however, to explicitly terminate the IPCP link before terminating the LCP connection.

PPP Authentication Protocols: Password Authentication Protocol (PAP) and Challenge Handshake Authentication Protocol (CHAP)

PPP was designed to provide layer two connectivity over a variety of serial links and other physical layer technologies, some of which have much more of a concern about security than others. For example, suppose you hook two machines in your computer lab together with a serial cable and want to run PPP between them. When one of these initiates a PPP link with the other, you don't really need to worry about "who's calling". On the other hand, consider an Internet Service Provider using PPP for remote dial-in users. They generally want to allow only their customers to connect, not just anyone.

The PPP protocol suite was designed to include the use of an optional authentication protocol for links where authentication is important. During basic link setup by LCP, devices can negotiate the use of an authentication protocol. If they agree, after the LCP link is set up a series of authentication messages are sent to verify the identity of the device initiating the link. Only if authentication is successful can the link configuration proceed.

The PPP suite initially defined two different authentication protocols: the *Password Authentication Protocol (PAP)* and *Challenge Handshake Authentication Protocol (CHAP)*.



Note: Incidentally, in addition to PAP and CHAP, it is possible to use proprietary authentication schemes. This requires that the appropriate configuration option values be programmed into LCP for placement in the *Authentication-Protocol* configuration option.

Password Authentication Protocol (PAP).

PAP is a very straight-forward authentication scheme, consisting of only two basic steps, as shown in [Figure 29](#):

1. **Authentication Request:** The initiating device sends an *Authenticate-Request* message that contains a name and a password.
2. **Authentication Reply:** The responding device looks at the name and password and decides whether to accept the initiating device and continue in setting up the link. If so, it sends back an *Authenticate-Ack*. Otherwise, it sends an *Authenticate-Nak*.

Simple. Now, [remember what Einstein said about simplicity?](#) PAP is another example of something that is just too simple for its own good. Chief amongst its flaws is that it transmits the user name and password in clear text across the link. This is a big "no-no" in security protocols, as it means any eavesdropper can get the password and use it in the future. PAP also provides no protection against various security attacks. For example, an unauthorized user could simply try different passwords indefinitely and hope he or she eventually found one that worked. PAP also puts control of the authentication squarely on the shoulders of the initiating device (usually a client machine) which is not considered desirable.

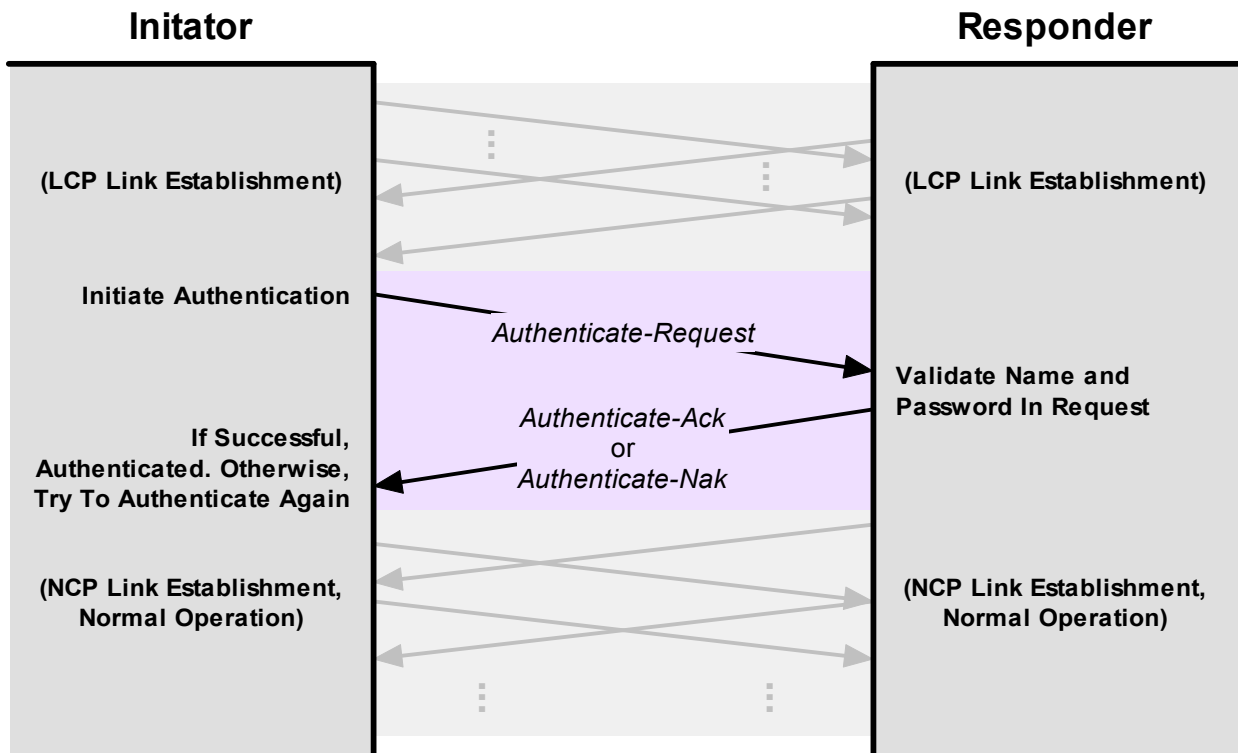

Figure 29: PPP Password Authentication Protocol (PAP) Authentication

PAP works using a simple exchange of a request containing name and password information, and a reply indicating whether or not authentication was successful.

Challenge Handshake Authentication Protocol (CHAP)

The most important difference between PAP and CHAP is that CHAP doesn't transmit the password across the link. Now you may be wondering—if that's the case, how is the password verified? Well, think of it this way. PAP works by the initiator telling the authenticator “here's the password I know, see if it matches yours”. CHAP does this by having each of the devices use the password to perform a cryptographic computation and then check if they each get the same result. If they do, they know they have the same password.

CHAP Authentication Procedure

In CHAP, a basic LCP link is set up between the initiator (calling client) and authenticator (generally the server that is deciding whether to grant authentication). The authenticator then takes charge of the authentication process, using a technique called a *three-way handshake*. This is a fairly common general authentication procedure; the same basic technique is used, for example, in IEEE 802.11 Shared Key Authentication.

The three-way handshake steps are as follows (and as illustrated in [Figure 30](#)):

1. **Challenge:** The authenticator generates a frame called a *Challenge* and sends it to the initiator. This frame contains a simple text message (sometimes called the *challenge text*). The message has no inherent special meaning so it doesn't matter if anyone intercepts it. The important thing is that after receipt of the *Challenge* both devices have the same challenge message.
2. **Response:** The initiator uses its password (or some other shared “secret” that the authenticators also knows) to encrypt the challenge text. It then sends the encrypted challenge text as a *Response* back to the authenticator.
3. **Success or Failure:** The authenticator performs the same encryption on the challenge text that the initiator did. If the authenticator gets the same result that the initiator sent it in the *Response*, the authenticator knows that the initiator had the right password when it did its encryption, so the authenticator sends back a *Success* message. Otherwise, it sends a *Failure* message.

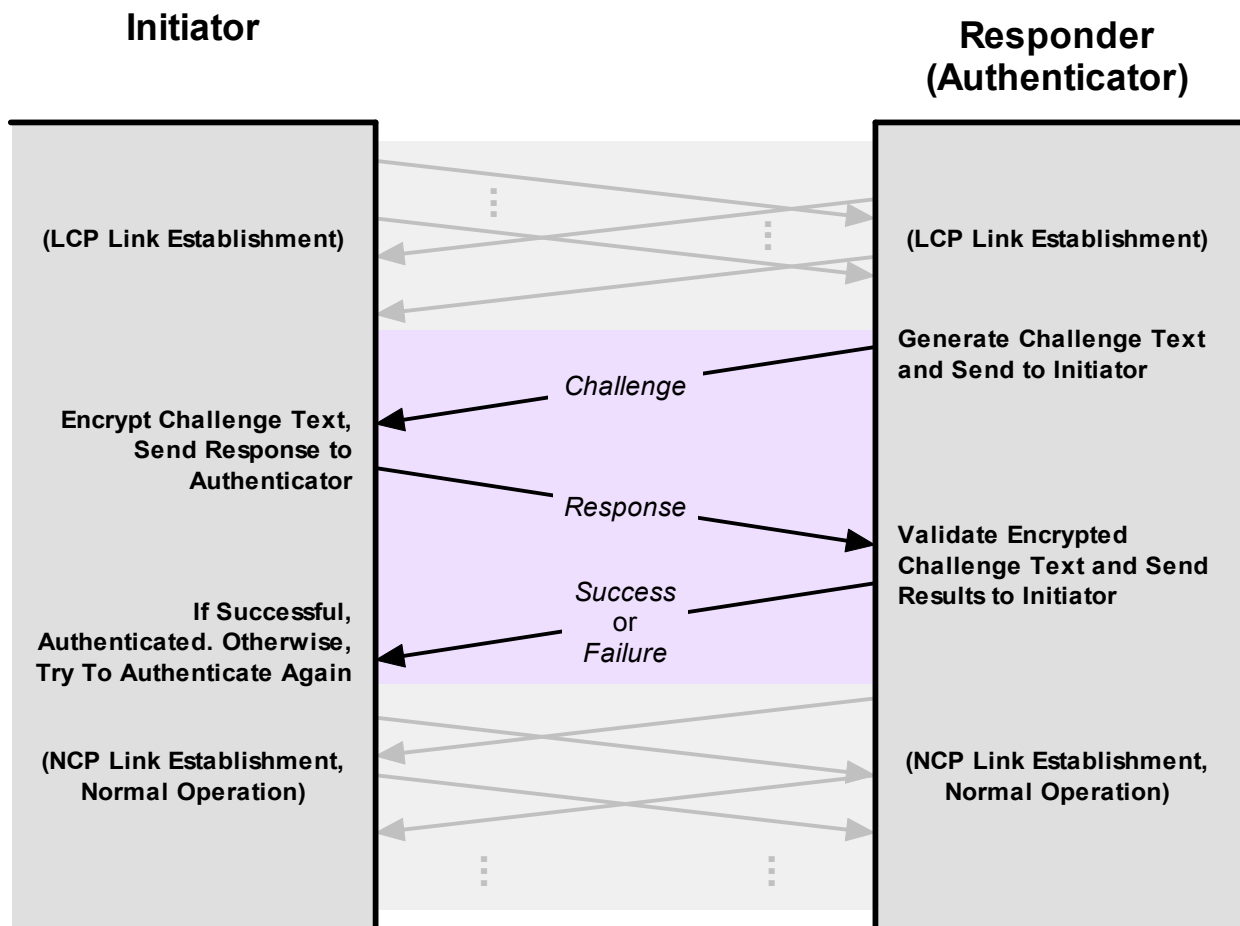

Figure 30: PPP Challenge Handshake Authentication Protocol (CHAP) Authentication

CHAP uses a three-way handshake beginning with a *Challenge* from the authenticating device (usually the remote server accessed by a host). This message is encrypted and returned to the authenticating device, which checks to see if the device trying to authenticate used the correct password (or other “shared secret”).

Benefits of CHAP

You can see the beauty of this: it verifies that the two devices have the same “shared secret” but doesn't require that the secret be sent over the link. The *Response* is calculated based on the password, but the content of the *Response* is encrypted and thus, much harder to derive the password from. CHAP also provides protection against replay attacks, where an unauthorized user captures a message and tries to send it again later on. This is done by changing an identifier in each message and varying the challenge text. Also, in CHAP the server controls the authentication process, not the client that is initiating the link.



Key Concept: PPP supports two authentication protocols: *PAP* and *CHAP*. *PAP* is a simple request/reply authentication protocol that is widely considered to be inadequate since it sends the user name and password in clear text and provides little protection against many security concerns. *CHAP* uses a three-way handshake procedure and is preferred over *PAP* in most implementations.

CHAP itself is not perfect, but it's a heck of a lot closer to perfection than *PAP* is. In fact, the IETF made a rather strong statement in this regard when it revised the original RFC describing *PAP* and *CHAP*, and [included only CHAP in the new standard](#). Despite this, *PAP* is still used in some applications, because it is simple. And well, some folks think they are smarter than Einstein. ☺ Seriously though, *PAP* can be fine in situations where security is not a big deal, but *CHAP* is much better and still not really that complicated.



PPP Feature Protocols

PPP is the standard for data link layer connectivity over serial links because its core protocols provide a solid operational foundation, as we saw in [the previous section](#). However, PPP's popularity is based not just on its highly capable link establishment and management features. It also has a number of very useful features that provide important security and performance benefits to network users.

In this section I describe the protocols that implement several of the most common "extra" features in PPP. I begin with a discussion of PPP link quality monitoring. I describe the sets of protocols used to configure and implement data compression and data encryption. I then discuss the PPP Multilink Protocol (MP, MLPPP), which allows PPP to bundle multiple low-speed links into a single high-speed link. I also cover the BAP and BACP protocols, which are used to manage the operation of Multilink PPP.

PPP Link Quality Monitoring/Reporting (LQM/LQR)

PPP includes optional authentication in recognition of the varying **security** needs of the many different kinds of links over which PPP may operate. These links also differ greatly in terms of their **quality**. Just as we don't need to worry about authentication much when two machines are linked with a short cable, we also can feel pretty confident that data sent between them is going to arrive intact. Now, contrast that to a PPP session established over a long-distance telephone call. For that matter, how about PPP over a dial-up call using an analog cellular phone?

PPP includes in its basic package a provision for detecting errors in sent frames (a CRC field), and higher-layer protocols like TCP also include methods of providing robustness on noisy lines. These techniques allow a link to **tolerate** problems, but provide little in the way of useful information about what the status of the link is. In some situations, devices may want to be able to keep track of how well the link is working, and perhaps take action on it. For example, a device experiencing too many errors on a dial-up connection might want to cut off and retry a new call. In some cases a device might want to try an alternate method of attachment if the current physical link is not working well.

Recognizing this need, the PPP suite includes a feature that allows devices to analyze the quality of the link between them. This is called *PPP Link Quality Monitoring* or *LQM*. PPP is set up generically to allow any number of different monitoring functions to be used, but at present there is only one, called *Link Quality Reporting (LQR)*. LQR works by having a device request that its peer (the other device on the link) keep track of statistics about the link and send them in reports on a regular basis.

LQR Setup

Before LQR can be used it must be set up, which is done by LCP as part of the negotiation of basic link parameters in the *Link Establishment* phase. The device opening the link requests link monitoring by including the *Quality-Protocol* configuration option in its

Configure-Request frame. Again, LQR is the only quality protocol presently defined. The configuration option also specifies a *reporting period* that indicates the longest period of time the requesting device wants to go between receiving reports.

LQR Counters

Assuming that the negotiation is successful, LQR will be enabled. A number of counters are set up that keep track of various link statistics, and a timer used to regulate the sending of quality reports over the link. Each time the timer expires a special link quality report is generated and sent in a PPP frame over the link. These are sent using the special PPP *Protocol* field [hexadecimal value 0xC025](#).

Each counter holds information about a different statistic regarding the use of the link. Each of these counters is reset to zero when LQR is set up and then incremented each time a transmission is made or an event occurs that is relevant to the counter. The statistics tracked include the following:

- ① The number of frames sent/received.
- ② The number of octets (bytes) in all frames sent/received.
- ③ The number of errors that have occurred.
- ④ The number of frames that had to be discarded.
- ⑤ The number of link quality reports generated.

These counters are only reset at the start of the link, so they contain figures kept cumulatively over the life of the connection. The counters can be used in the absolute sense, meaning that the counter value itself is reported. Alternately, they can be expressed as relative (or delta) values, which represent the change since the last report. This is done when a report is received simply by subtracting the previous report's numbers from those in the current report.

Using Link Quality Reports

LQR specifies the quality reporting mechanism, but not specific standards for link quality, since these are so implementation-dependent. Based on the numbers in these reports, a device can decide for itself what conclusions to draw about link quality, and in turn what action to take, if any. For example:

- ① Some devices might decide to shut down a link if the absolute number of errors seen in any report reaches a certain threshold.
- ② Some might look at the trend in successive reporting periods and take action if they detect certain trends, such as an increase in the rate of discarded frames.
- ③ Some devices might just log the information and take no action at all.

Note that LQR aggregates its statistics for all higher-layer protocols transmitted over a particular link. It doesn't keep track of statistics for different higher-layer protocols separately (which makes sense, since the quality of the link shouldn't vary from one higher layer protocol to the next).

PPP Compression Control Protocol (CCP) and Compression Algorithms

PPP is, of course, primarily used to provide data link layer connectivity to physical serial links. One of the biggest problems with serial links compared to many other types of layer one connections is that they are relatively slow. Consider that while 10 Mbps regular Ethernet is considered sluggish by modern LAN standards, it is actually much faster than most serial lines used for WAN connectivity, which can be 10, 100 or even 1000 times slower.

One way to improve performance over serial links is to use compression on the data sent over the line. Depending on the data transferred, this can double the performance compared to uncompressed transmissions, and can in some cases do even better than that. For this reason, many hardware devices include the ability to compress the data stream at the physical layer. The best example of this is probably the set of compression protocols used on analog modems.

Some physical links don't provide any compression capabilities, but could still benefit from it. To this end, an optional compression feature was created for PPP. It is implemented using two distinct protocol components:

- ☉ **PPP Compression Control Protocol (CCP):** This protocol is responsible for negotiating and managing the use of compression on a PPP link.
- ☉ **PPP Compression Algorithms:** A set of compression algorithms that perform the actual compression and decompression of data. Several of these are defined in Internet standards ([RFCs](#)). In addition, it is possible for two devices to negotiate the use of a proprietary compression method if they want to use one not defined by a public standard.



Key Concept: PPP includes an optional compression feature, which can improve performance over slow physical links. A variety of different compression algorithms are supported. To enable compression, both devices on a PPP link use the *PPP Compression Control Protocol (CCP)* to negotiate a compression algorithm to use. The compression algorithm is then used to compress and decompress PPP data frames.

CCP Operation: Compression Setup

When most people talk about compression in PPP they mention CCP, which is considered “the” compression protocol for PPP. However, CCP is actually used only to configure and control the use of compression; it is the algorithms that do the real work of compressing and decompressing. This “separation of powers” provides flexibility, since it allows each implementation to choose what type of compression they wish to use.

CCP is analogous to the [Network Control Protocols \(NCPs\)](#) that negotiate parameters specific to a network layer protocol sent on the link. An NCP lets two devices decide how they will carry layer three traffic, such as how IPCP lets the devices determine how to carry IP. CCP lets two devices decide how they will compress data, in the same basic way.

Similarly, just as each NCP is like a “lite” version of LCP, CCP is also like a “lite” version of LCP. It is used to set up a compression connection called a *CCP link* within an LCP link between two devices. Once established, compressed frames can be sent between the two devices. CCP also provides messaging capabilities for managing and eventually terminating a CCP link, again very similar to how each network layer protocol sets up a NCP link within LCP. A CCP link is maintained independently of any NCP links.

CCP uses the same subset of seven LCP message types that the NCPs use, and adds two additional ones. The use of these messages for each of the “life stages” of a CCP link is as follows, which should look very familiar if you've already read about how the NCPs and LCP itself work:

- ☉ **Link Configuration:** Like the NCPs, compression configuration is done once CCP reaches the *Network-Layer Protocol* phase. The process of setting up compression and negotiating parameters is accomplished using *Configure-Request*, *Configure-Ack*, *Configure-Nak* and *Configure-Reject* messages [just as described in the LCP topic](#), except the configuration options are particular to CCP.
- ☉ **Link Maintenance:** *Code-Reject* messages can be sent to indicate invalid code values in CCP frames. The two new message types are *Reset-Request* and *Reset-Ack*, which are used to reset the compression (the CCP link) in the event of a detected failure in decompression.
- ☉ **Link Termination:** A CCP link can be terminated using *Terminate-Request* and *Terminate-Ack*. Again, remember that like the NCP links, the CCP link is set up within an LCP link, and closing it doesn't terminate the LCP link which controls PPP overall.

CCP Configuration Options and Compression Algorithms

CCP configuration options are used for only one purpose: to negotiate the type of compression to be used by the two devices, and the specifics of how that algorithm is to be employed. The device initiating the negotiation sends a *Configure-Request* with one option for each of the compression algorithms it supports. The other device compares this list of options to the algorithms it understands. It also checks for any specific details relevant to the option to see if it agrees on how that algorithm should be used. It then sends back the appropriate reply (*Ack*, *Nak* or *Reject*) and a negotiation ensues until the two devices come up with a common algorithm both understand. If so, compression is turned on; otherwise, it is not enabled.

The CCP configuration options begin with a *Type* value that indicates the compression algorithm. When the *Type* value is 0, this indicates that the option contains information about a special, proprietary compression algorithm not covered by any RFC standards, which can be used if both devices understand it. Several values from 1 to 254 indicate

compression algorithms that have been defined for use with CCP. [Table 31](#) shows the most common values of the *Type* field, including the compression algorithm each corresponds to and the number of the RFC that defines it:

Table 31: PPP Compression Control Protocol (CCP) Compression Algorithms

CCP Option Type Value	Defining RFC	Compression Algorithm (As Given in RFC Title)
0	—	Proprietary
1 and 2	1978	<i>PPP Predictor Compression Protocol</i>
17	1974	<i>PPP Stac LZS Compression Protocol</i>
18	2118	<i>Microsoft Point-To-Point Compression (MPPC) Protocol</i>
19	1993	<i>PPP Gandalf FZA Compression Protocol</i>
21	1977	<i>PPP BSD Compression Protocol</i>
23	1967	<i>PPP LZS-DCP Compression Protocol (LZS-DCP)</i>
26	1979	<i>PPP Deflate Protocol</i>

Compression Algorithm Operation: Compressing and Decompressing Data

Once an algorithm has been successfully negotiated, the compression algorithm is used to compress data before transmission, and to decompress it once received. To compress, the transmitting device takes the data that would normally be put in the *Information* field of an uncompressed PPP frame and runs it through the compression algorithm. To indicate that a frame has been compressed, the special value 0x00FD (hexadecimal) is placed in the PPP *Protocol* field. When compression is used with multiple links and the links are compressed independently, a different value is used: 0x00FB. Recall that in a regular uncompressed frame, the *Protocol* field indicates what layer three protocol the data comes from; since we still need to know this, the original *Protocol* value is actually prepended to the data before compression. When the data is decompressed, this value is used to restore the original *Protocol* field, so the receiving device knows what higher layer the data belongs to.

For example, if we use IPCP to encapsulate IP data in PPP, the uncompressed frame would have a value of 0x8021 (hex) in the *Protocol* field. This value (0x8021) would be placed at the start of the data to be compressed. The compressed data would be put in a PPP frame with a *Protocol* value of 0x00FD. The receiving device would see the value 0x00FD in the *Protocol* field, recognize the frame as compressed, decompress it and restore the original frame with 0x8021 as the *Protocol* value. The [PPP general frame format topic](#) covers this in more detail.

In theory, a compression algorithm can put more than one PPP data frame into a compressed PPP data frame. Despite this, many if not most of the algorithms maintain a one-to-one correspondence, putting each PPP data frame into one compressed frame. Note that LCP frames are not compressed, nor are the control frames used for other protocols. For example, a data frame carrying IP traffic would be compressed, but a control frame for IPCP (the Network Control Protocol for IP) would not be.

Compression can be combined with encryption; in this case compression is done before encryption.



Note: The compression performed by CCP has nothing to do with the header compression options that can be negotiated as part of LCP. That type of “compression” doesn’t involve compressing a data stream using a compression algorithm, but rather a simple way of saving space in headers when both ends of a link agree to do so.

PPP Encryption Control Protocol (ECP) and Encryption Algorithms

The [PPP authentication protocols PAP and CHAP](#) can be used to ensure that only authorized devices can establish a PPP connection. Once that is done, PPP normally provides no other security to the data being transmitted. In particular, all data is normally sent “in the clear” (unencrypted), making it easy for someone who intercepts it to read. For important data that must be kept secure, encryption prior to transmission is a good idea. This can be done at higher layers using something like [IPSec](#), but PPP also provides an optional feature that allows data to be encrypted and decrypted at the data link layer itself.



Note: This topic is very similar in structure and content to the [preceding one that covers PPP compression](#), because the features are implemented in a very similar way. For the benefit of those who may not be reading in sequence I have provided a standalone description in this topic, without assuming you have read the prior topic on compression. This means this topic may seem almost like “deja vu” if you just read the topic on CCP.

PPP data encryption is implemented using two protocol components:

- **PPP Encryption Control Protocol (ECP):** This protocol is responsible for negotiating and managing the use of encryption on a PPP link.
- **PPP Encryption Algorithms:** A family of encryption algorithms that perform the actual encryption and decryption of data. Several of these are defined in Internet standards (RFCs), and two devices can also negotiate a proprietary encryption method if they want to use one not defined by a public standard.

ECP is usually the only part mentioned when encryption in PPP is discussed. ECP is in fact used only to configure and control the use of encryption; it is the algorithms that do the real work. This technique allows each implementation to choose what type of encryption they wish to use. The original ECP defined only a single encryption method, and a couple of others have since been added.



Key Concept: PPP includes an optional encryption feature, which provides privacy for data transported over PPP. A number of encryption algorithms are supported. To enable encryption, both devices on a PPP link use the *PPP Encryption Control Protocol (ECP)* to negotiate which algorithm to use. The selected algorithm is then used to encrypt and decrypt PPP data frames.

ECP Operation: Compression Setup

Like CCP, ECP is analogous to the [Network Control Protocols \(NCPs\)](#) that negotiate parameters specific to a network layer protocol sent on the link, but deals with how devices encrypt data rather than how they transport layer three traffic. This also means that like the NCPs, ECP is a "lite" version of LCP and works in the same basic way. Once an ECP link is negotiated, encrypted frames can be sent between devices. When no longer needed, the ECP link can be terminated.

ECP uses the same subset of seven LCP message types that the NCPs use, and adds two more. The use of these messages for each of the "life stages" of an ECP link is as follows:

- ☉ **Link Configuration:** Like the NCPs (and also like CCP of course), encryption configuration is done once ECP reaches the *Network-Layer Protocol* phase. The process of setting up encryption and negotiating parameters is accomplished using *Configure-Request*, *Configure-Ack*, *Configure-Nak* and *Configure-Reject* messages just [as described in the LCP topic](#), except the configuration options are particular to ECP.
- ☉ **Link Maintenance:** *Code-Reject* messages can be sent to indicate invalid code values in ECP frames. The two new message types are *Reset-Request* and *Reset-Ack*, which are used to reset the encryption (the ECP link) in the event of a detected failure in decryption.
- ☉ **Link Termination:** An ECP link can be terminated using *Terminate-Request* and *Terminate-Ack*. Again, remember that like the NCP links, the ECP link is set up within an LCP link, so closing it doesn't terminate the LCP link.

ECP Configuration Options and Encryption Algorithms

ECP configuration options are used only to negotiate the type of encryption algorithm to be used by the two devices, and the specifics of how that algorithm is to be employed. The device initiating the negotiation sends a *Configure-Request* with one option for each of the encryption algorithms it supports. The other device compares this list of options to the algorithms it understands. It also checks for any details relevant to the option to see if it agrees on how that algorithm should be used. It then sends back the appropriate reply (*Ack*, *Nak* or *Reject*) and a negotiation ensues until the two devices come up with a common algorithm both understands. If so, encryption is enabled, and otherwise, it is left turned off.

The ECP configuration options begin with a *Type* value that indicates the encryption algorithm. When the *Type* value is 0, this indicates that the option contains information about a special, proprietary encryption method not covered by any RFC standards, which can be used if both devices understand it. Values in the range from 1 to 254 indicate

encryption algorithms that have been defined for use with ECP; at present, only two are defined. [Table 32](#) shows the values of the *Type* field, including the encryption algorithm each corresponds to and the number of the RFC that defines it:

Table 32: PPP Encryption Control Protocol (ECP) Encryption Algorithms

ECP Option Type Value	Defining RFC	Encryption Algorithm (As Given in RFC Title)
0	—	Proprietary
2	2420	<i>The PPP Triple-DES Encryption Protocol (3DESE)</i>
3	2419	<i>The PPP DES Encryption Protocol, Version 2 (DESE-bis)</i>



Note: *Type* value 1 was for the original DES algorithm, defined in RFC 1969, which was superseded by DES version 2 in RFC 2419.

Encryption Algorithm Operation: Encrypting and Decrypting Data

After an encryption algorithm has been successfully negotiated, it is used to encrypt data before transmission, and to decrypt data received. To encrypt, the transmitting device takes the data that would normally be put in the *Information* field of an unencrypted PPP frame and runs it through the encryption algorithm. To indicate that a frame has been encrypted, the special value 0x0053 (hexadecimal) is placed in the PPP *Protocol* field. When encryption is used with multiple links and the links are encrypted independently, a different value is used: 0x0055. Recall that in a regular unencrypted frame, the *Protocol* field indicates what layer three protocol the data comes from; since we still need to know this, the original *Protocol* value is actually prepended to the data before encryption. When the data is decrypted, this value is used to restore the original *Protocol* field, so the receiving device knows what higher layer the data belongs to.

For example, if we use IPCP to encapsulate IP data in PPP, the unencrypted frame would have a value of 0x8021 (hex) in the *Protocol* field. This value (0x8021) would be placed at the start of the data to be encrypted. The encrypted data would be put in a PPP frame with a *Protocol* value of 0x0053. The receiving device would see the value 0x0053 in the *Protocol* field, recognize the frame as encrypted, decrypt it and restore the original frame with 0x8021 as the *Protocol* value. The [discussion of the PPP general frame format](#) covers this more completely.

Each encrypted PPP data frame carries exactly one PPP data frame. Note that unlike what we saw in compression, LCP frames and the control frames used for other protocols **can** be encrypted. Compression can be combined with encryption; in this case compression is done before encryption.

PPP Multilink Protocol (MP/MLP/MLPPP)

Most of the time, there is only a single physical layer link between two devices. There are some situations, however, when there may actually be two layer one connections between the same pair of devices. This may seem strange; why would there be more than one link between any pair of machines?

There are in fact a number of situations in which this can occur. One common one is when two links are intentionally placed between a pair of devices. This is often done to increase performance by “widening the pipe” between two devices, without going to a newer, more expensive technology. For example, if two machines are connected to each other using a regular analog modem and it is too slow, a relatively simple solution is to just use two analog modem pairs connecting the machines to double bandwidth.

A slightly different situation occurs when multiplexing creates the equivalent of several physical layer “channels” between two devices even if they only have one hardware link between them. Consider ISDN for example. The most common form of ISDN service (ISDN basic rate interface or BRI) creates two 64,000 bps *B channels* between a pair of devices. These B channels are time division multiplexed and carried along with a D channel on a single pair of copper wire, but to the devices they appear **as if** there were two physical layer links between devices, each of which carries 64 kbps of data. And the ISDN primary rate interface (PRI) actually creates 23 or even more channels, all between the same pair of hardware devices.

In a situation where we have multiple links, we could of course just establish PPP over each connection independently. However, this is far from an ideal solution, because we would then have to manually distribute our traffic over the two (or more) channels or links that connect them. If you wanted to connect to the Internet, you'd have to make separate connections and then choose which to use for each action. Not exactly a recipe for fun, and what's worse is that you could never use all the bandwidth for a single purpose, such as downloading the latest 100 megabyte Microsoft security patch.

What we really want is a solution that will let us combine multiple links and use them as if they were one high-performance link. Some hardware devices actually allow this to be done at the hardware level itself; in ISDN this technology is sometimes called *bonding* when done at layer one. For those hardware units that don't provide this capability, PPP makes it available in the form of the *PPP Multilink Protocol (MP)*. This protocol was originally described in RFC 1717, and was updated in RFC 1990.



Note: The PPP Multilink Protocol is properly abbreviated “MP”, but it is common to see any of a multitude of other abbreviations used for it. Many of these are actually derived from changing the order of the words in the name into “Multilink PPP”, so you will frequently see this called “ML PPP”, “MLPPP”, “MPPP”, “MLP” and so forth. These are technically “incorrect” but widely used, especially “MLPPP”. I use the correct abbreviation in this Guide.

PPP Multilink Protocol Architecture

MP is an optional feature of PPP, so it must be designed to integrate seamlessly into regular PPP operation. To accomplish this, MP is implemented as a new architectural “sublayer” within PPP. In essence, an MP sublayer is inserted between the “regular” PPP mechanism and any network layer protocols using PPP, as shown in [Figure 31](#). This allows MP to take all network layer data to be sent over the PPP link and spread it over multiple physical connections, without causing either the normal PPP mechanisms or the network layer protocol interfaces to PPP to “break”.

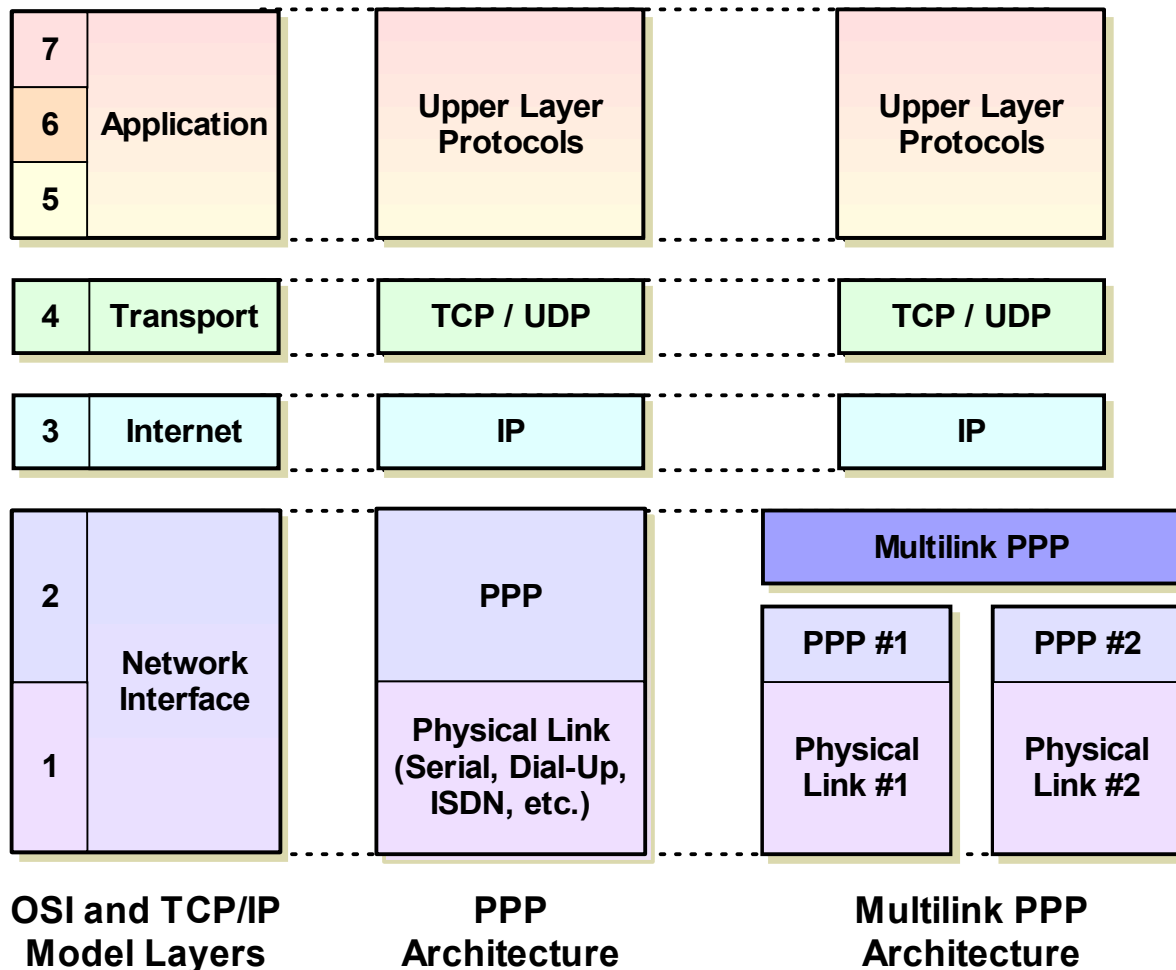

Figure 31: Multilink PPP Architecture

The column on the left shows the TCP/IP model architecture with corresponding [OSI Reference Model](#) layer numbers. The center column shows the normal PPP layer architecture. When Multilink PPP is used, there are separate PPP implementations running over each of two or more physical links. Multilink PPP sits, architecturally, between these links and any network layer protocols to be transported over those links. (In this diagram only IP is shown, since it is most common, but Multilink PPP can in fact work with multiple network layer protocols, each being sent over each physical link.)



Key Concept: The *PPP Multilink Protocol (MP)* allows PPP to bundle multiple physical links and use them like a single, high-capacity link. It must be enabled during link configuration. Once operational, it works by fragmenting whole PPP frames and sending the fragments over different physical links.

PPP Multilink Protocol Setup and Configuration

To use MP, both devices must have it implemented as part of their PPP software and must negotiate its use. This is done by LCP as part of the negotiation of basic link parameters in the *Link Establishment* phase (just like [Link Quality Reporting](#)). Three new configuration options are defined to be negotiated to enable MP:

- ☉ ***Multilink Maximum Received Reconstructed Unit:*** Provides the basic indication that the device starting the negotiation supports MP and wants to use it. The option contains a value specifying the maximum size of PPP frame it supports. If the device receiving this option does not support MP it must respond with a *Configure-Reject LCP* message.
- ☉ ***Multilink Short Sequence Number Header Format:*** Allows devices to negotiate use of a shorter sequence number field for MP frames, for efficiency. (See the [topic on MP frames](#) for more.)
- ☉ ***Endpoint Discriminator:*** Uniquely identifies the system; used to allow devices to determine which links go to which other devices.

Before MP can be used, a successful negotiation of at least the *Multilink Maximum Received Reconstructed Unit* option must be performed on each of the links between the two devices. Once this is done and an LCP link exists for each of the physical links, a virtual *bundle* is made of the LCP links and MP is enabled.

PPP Multilink Protocol Operation

As mentioned above, MP basically sits between the network layer and the regular PPP links and acts as a “middleman”. Here is what it does for each “direction” of communication:

- ☉ ***Transmission:*** MP accepts datagrams received from any of the network layer protocols configured using appropriate NCPs. It first encapsulates them into a modified version of the regular PPP frame. It then takes that frame and decides how to transmit it over the multiple physical links. Typically, this is done by dividing the frame into *fragments* that are evenly spread out over the set of links. These are then encapsulated and sent over the physical links. However, an alternate strategy can also be implemented as well, such as alternating full-sized frames between the links. Also, smaller frames are typically not fragmented, nor are control frames such as those used for link configuration.
- ☉ ***Reception:*** MP takes the fragments received from all physical links and reassembles them into the original PPP frame. That frame is then processed like any PPP frame, by looking at its *Protocol* field and passing it to the appropriate network layer protocol.

The fragments used in MP are similar in concept to IP fragments, but of course these are different protocols running at different layers. To PPP or MP, an IP fragment is just an IP datagram like any other.

The fragmenting of data in MP introduces a number of complexities that the protocol must handle. For example, since fragments are being sent roughly concurrently, we need to identify them with a sequence number to facilitate reassembly. We also need some control information to identify the first and last fragments. A [special frame format is used for MP fragments](#) to carry this extra information, which I describe in the [section on PPP frame formats](#). That topic also contains more information about how fragmenting is accomplished, as well as an illustration that demonstrates how it works.



Related Information: I also recommend reading the next topic, which describes two protocols defined after MP to better control how it works: BAP and BACP.

PPP Bandwidth Allocation Protocol (BAP) and Bandwidth Allocation Control Protocol (BACP)

The [PPP Multilink Protocol \(MP\)](#) described in the previous topic allows multiple links between a pair of devices, whether physical or in the form of virtual channels, to be combined into a “fat pipe” (high-capacity channel). This offers tremendous advantages to many PPP users, as it lets them make optimal use of all their bandwidth, especially for applications such as Internet connectivity. It's no surprise, then, that MP has become one of the most popular features of PPP.

The original standard defining MP basically assumed that multiple links would be combined into a single bundle. For example, if you had two modem links they would both be connected and then combined, or two B channels in an ISDN link would be combined. After MP was set up the bundle would be available for either device to use in its entirety.

There's one drawback to this system: the “fat pipe” is always enabled, and in many cases, it is expensive to have this set up all the time. It often costs more to connect two or more layer one links than a single one, and it's not always needed. For example, some ISDN services charge per minute for calls on either of the B channels. In the case of modem dialup there are per-minute charges in some parts of the world. Even where regular phone calls are “free”, there is a cost in the form of tying up a phone line. Consider that in many applications, the amount of bandwidth needed varies over time.

It would be better if we could set up MP so that it could dynamically add links to the bundle when needed, such as when we decided to download some large files, and then automatically drop them when no longer required. This enhancement to the basic MP package was provided in the form of a pair of new protocols described in RFC 2125:

-
- ☉ **Bandwidth Allocation Protocol (BAP):** Describes a mechanism where either device communicating over an MP bundle of layer one links may request that a link be added to the bundle or removed from it.
 - ☉ **Bandwidth Allocation Control Protocol (BACP):** Allows devices to configure how they want to use BAP.



Key Concept: *BAP* and *BACP* are used to provide dynamic control over how the PPP Multilink Protocol functions.

BACP Operation: Configuring the Use of BAP

Let's start with BACP, since it is the protocol used for initial setup of the feature. BACP is very similar in general concept to all those other PPP protocols with “Control” in their names, such as **LCP**, the **NCP family**, **CCP** and **ECP**, but is actually even simpler. It is used only during link configuration to set up BAP. This is done using *Configure-Request*, *Configure-Ack*, *Configure-Nak* and *Configure-Reject* messages just as described in the LCP topic. The only configuration option that is negotiated in BACP is one called *Favored-Peer*, which is used to ensure that the two devices on the link don't get “stuck” if each tries to send the same request at the same time.

If both devices support BAP then the BACP negotiation will succeed and BAP will be activated.

BAP Operation: Adding and Removing Links

BAP defines a special set of messages that can be sent between devices to add or drop links to/from the current PPP bundle. What's particularly interesting about BAP is that it includes the tools necessary to have a device actually initiate different types of physical layer connections (such as dialing a modem for bundled analog links or enabling an extra ISDN channel) when more bandwidth is required, and then shut them down when no longer needed.

A brief description of the BAP message types:

- ☉ ***Call-Request and Call-Response:*** When one device on the link wants to add a link to the bundle and initiate the new physical layer link itself, it sends a *Call-Request* frame to tell the other device, which replies with a *Call-Response*.
- ☉ ***Callback-Request and Callback-Response:*** These are just like the two message types above, but used when a device wants its peer (the other device on the link) to initiate the call to add a new link. So, if device A says “I need more bandwidth but I want you to call me, instead of me calling you”, it sends device B a *Callback-Request*.
- ☉ ***Call-Status-Indication and Call-Status-Response:*** After a device attempts to add a new link to the bundle (after sending a *Call-Request* or receiving a *Callback-Request*) it reports the status of the new link using the *Call-Status-Indication* frame. The other device then replies with a *Call-Status-Response*.

-
- ☉ ***Link-Drop-Query-Request*** and ***Link-Drop-Query-Response***: These messages are used by one device to request that a link be dropped and the other to respond to that request.

I should also point out that the decision of when to add or remove links is not made by these protocols. It is left up to the particular implementation.



PPP Protocol Frame Formats

The PPP protocol suite includes a number of different protocols used to send both data and control information in different ways. Each of these packages information into messages called *frames*, each of which follows a particular *frame format*. PPP starts with a general frame format that encompasses all frames sent on the link, and then includes more specific formats for different purposes. Understanding these formats not only makes diagnosing PPP issues easier, it also helps make more clear how the key PPP protocols function.

In this section I illustrate the most common frame formats used for sending both data and control information over PPP. I begin with an explanation of the overall format used for all PPP frames. I also describe the general format used for the various control protocols and the option format that most of them use. (One of the nice things about PPP is that so many of the protocols use control frames with a common format.)

I then specifically list the frames used for the Link Control Protocol (LCP) and the authentication protocols (PAP and CHAP). I also describe the special format used by the PPP Multilink Protocol (MP) to transport fragments of data over bundled links.



Note: Due to the sheer number of different protocols in PPP (dozens) and the fact that many have their own unique options, I cannot describe all the specific frame formats and option formats for every protocol in detail here. Please refer to the appropriate RFCs (shown in the topic on PPP standards) if you need more detail than provided in this section.

PPP General Frame Format

All messages sent using PPP can be considered either *data* or *control information*. The word “data” describes the higher-layer datagrams we are trying to transport here at layer two; this is what our “customers” are giving us to send. Control information is used to manage the operation of the various protocols within PPP itself. Even though different protocols in the PPP suite use many types of frames, at the highest level they all fit into a single, *general frame format*.

In the overview of PPP I mentioned that the basic operation of the suite is based on the ISO High-Level Data Link Control (HDLC) protocol. This becomes very apparent when we look at the structure of PPP frames overall—they use the same basic format as HDLC, even to the point of including certain fields that aren't strictly necessary for PPP itself. The only major change is the addition of a new field to specify the protocol of the encapsulated data. The general structure of PPP frames is defined in RFC 1662, a “companion” to the main PPP standard RFC 1661.

The general frame format for PPP, showing how the HDLC framing is applied to PPP, is described in [Table 33](#) and illustrated in [Figure 32](#).

Table 33: PPP General Frame Format

Field Name	Size (bytes)	Description
<i>Flag</i>	1	Flag: Indicates the start of a PPP frame. Always has the value “01111110” binary (0x7E hexadecimal, or 126 decimal).
<i>Address</i>	1	Address: In HDLC this is the address of the destination of the frame. But in PPP we are dealing with a direct link between two devices, so this field has no real meaning. It is thus always set to “11111111” (0xFF or 255 decimal), which is equivalent to a broadcast (it means “all stations”).
<i>Control</i>	1	Control: This field is used in HDLC for various control purposes, but in PPP it is set to “00000011” (3 decimal).
<i>Protocol</i>	2	Protocol: Identifies the protocol of the datagram encapsulated in the Information field of the frame. See below for more information on the <i>Protocol</i> field.
<i>Information</i>	Variable	Information: Zero or more bytes of payload that contains either data or control information, depending on the frame type. For regular PPP data frames the network-layer datagram is encapsulated here. For control frames, the control information fields are placed here instead.
<i>Padding</i>	Variable	Padding: In some cases, additional dummy bytes may be added to pad out the size of the PPP frame.
<i>FCS</i>	2 (or 4)	Frame Check Sequence (FCS): A checksum computed over the frame to provide basic protection against errors in transmission. This is a CRC code similar to the one used for other layer two protocol error protection schemes such as the one used in Ethernet. It can be either 16 bits or 32 bits in size (default is 16 bits). The FCS is calculated over the <i>Address</i> , <i>Control</i> , <i>Protocol</i> , <i>Information</i> and <i>Padding</i> fields.
<i>Flag</i>	1	Flag: Indicates the end of a PPP frame. Always has the value “01111110” binary (0x7E hexadecimal, or 126 decimal).

[Figure 33](#) shows one common application of the PPP general frame format: carrying data. The value 0x0021 in the *Protocol* field marks this as an IPv4 datagram. This sample has one byte of *Padding* and a 2-byte *FCS* as well. (Obviously real IP datagrams are longer than the 23 bytes shown here! These bytes are arbitrary and don’t represent a real datagram.) See [Figure 43](#) for an illustration of how this same data frame is formatted and then fragmented for transmission over multiple links using the [PPP Multilink Protocol](#).

Protocol Field Ranges

The *Protocol* field is the main “frame type” indicator for the device receiving the frame. For data frames this is normally the network-layer protocol that created the datagram, and for control frames, the PPP protocol that created the control message. In the case of protocols

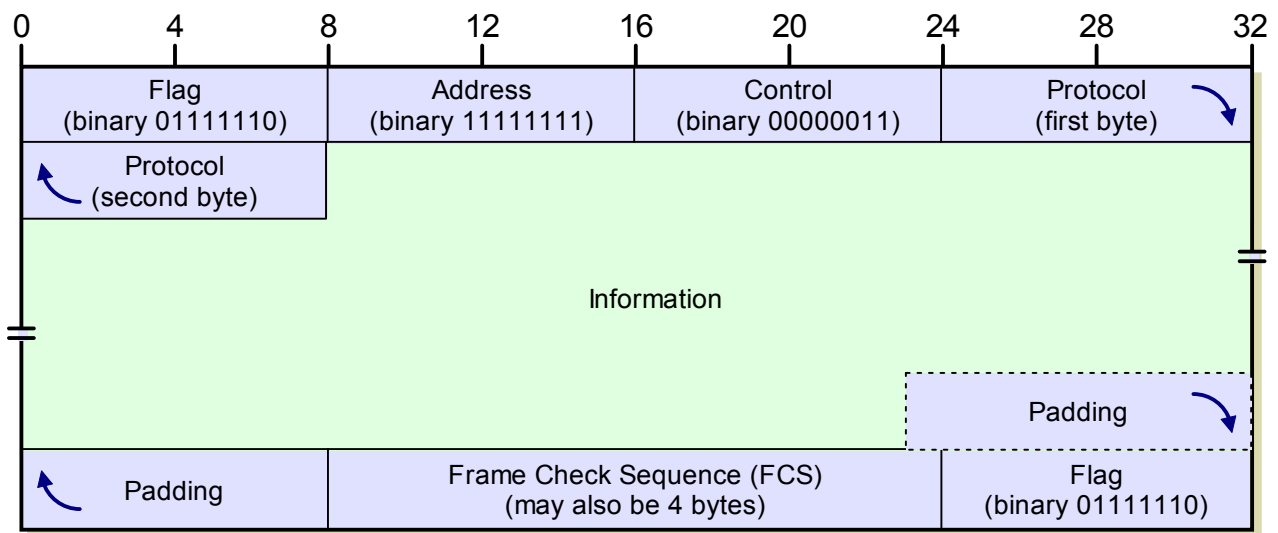

Figure 32: PPP General Frame Format

All PPP frames are built upon the general format shown above. The first three bytes are fixed in value, followed by a two-byte *Protocol* field that indicates the frame type. The variable-length *Information* field is formatted in a variety of ways, depending on the PPP frame type. *Padding* may be applied to the frame, which concludes with an *FCS* field of either 2 or 4 bytes (2 bytes shown here) and a trailing *Flag* value of 0x7E. See [Figure 33](#) for an example of how this format is applied.

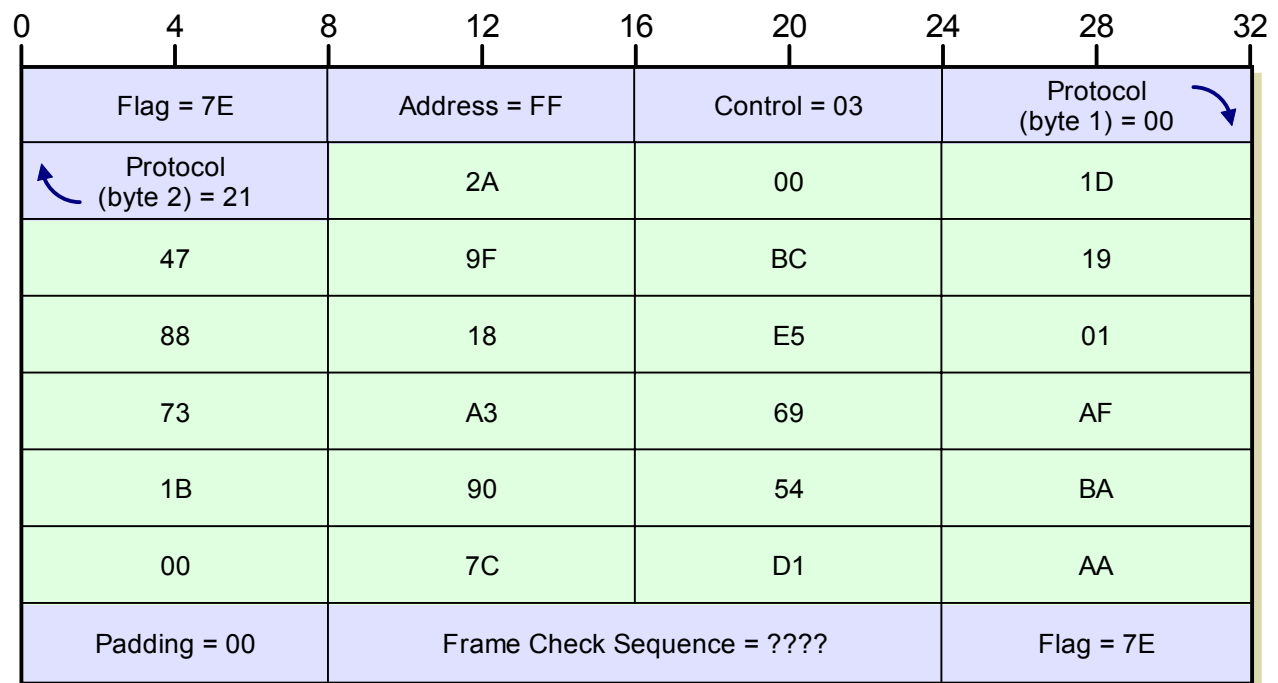

Figure 33: Sample PPP Data Frame

This sample PPP data frame has a value of 0x0021 in the *Protocol* field, indicating it is an IP datagram (though the actual data is made up and not a real IP message.)

that modify data such as when [compression \(CCP\)](#) or [encryption \(ECP\)](#) are used, this field identifies the data as being either compressed or encrypted, and the original *Protocol* value is extracted after the *Information* field is decompressed/decrypted.

There are dozens of network-layer protocols and PPP control protocols, and a correspondingly large number of *Protocol* values. The main PPP standard defines four ranges for organizing these values, as shown in [Table 34](#).

Table 34: PPP *Protocol* Field Ranges

Protocol Field Range (hexadecimal)	Description
0000 - 3FFF	Encapsulated network layer datagrams that have an associated Network Control Protocol (NCP) . In this case, control frames from the corresponding NCP use a <i>Protocol</i> field value that is computed by adding “8” to the first octet of the network layer <i>Protocol</i> value. For example, for IP the <i>Protocol</i> value is 0021, and control frames from the IP Control Protocol (IPCP) use <i>Protocol</i> value 8021. This range also includes several values used for specially-processed encapsulated datagrams, such as when compression or encryption are employed.
4000 - 7FFF	Encapsulated datagrams from “low-volume” protocols. These are protocols that do not have an associated NCP.
8000 - BFFF	Network Control Protocol (NCP) control frames that correspond to the network layer <i>Protocol</i> values in the 0000-3FFF range.
C000 - FFFF	Control frames used by LCP and LCP support protocols such as PAP and CHAP . Some miscellaneous protocol values are included here as well.

The standard also specifies that the *Protocol* value must be assigned so that the first octet is even, and the second octet is odd. So, for example, 0x0021 is a valid value but 0x0121 and 0x0120 are not. (The reason for this will become apparent shortly). There are also certain blocks that are reserved and not used.

Protocol Field Values

The full list of PPP *Protocol* values is maintained by the [Internet Assigned Numbers Authority \(IANA\)](#) along with all the other different reserved numbers for Internet standards. [Table 35](#) shows some of the more common values:

Table 35: Common Protocols Carried In PPP Frames and *Protocol* Field Values (Page 1 of 2)

Protocol Type	Protocol Field Value (hex)	Protocol
Encapsulated Network Layer Datagrams	0021	Internet Protocol version 4 (IPv4)
	0023	OSI Network Layer
	0029	Appletalk
	002B	Novell Internetworking Packet Exchange (IPX)
	003D	PPP Multilink Protocol (MP) Fragment
	003F	NetBIOS Frames (NBF/NetBEUI)
	004D	IBM Systems Network Architecture (SNA)
	0053	Encrypted Data (using ECP and a PPP encryption algorithm)
	0055	Individual-Link Encrypted Data under PPP Multilink
	0057	Internet Protocol version 6 (IPv6)
	00FB	Individual-Link Compressed Data under PPP Multilink
	00FD	Compressed Data (using CCP and a PPP compression algorithm)
Low-Volume Encapsulated Protocols	4003	CDPD Mobile Network Registration Protocol
	4025	Fibre Channel
Network Control Protocol (NCP) Control Frames	8021	PPP Internet Protocol Control Protocol
	8023	PPP OSI Network Layer Control Protocol
	8029	PPP Appletalk Control Protocol
	802B	PPP IPX Control Protocol
	803F	PPP NetBIOS Frames Control Protocol
	804D	PPP SNA Control Protocol
	8057	PPP IPv6 Control Protocol

Table 35: Common Protocols Carried In PPP Frames and *Protocol* Field Values (Page 2 of 2)

Protocol Type	<i>Protocol</i> Field Value (hex)	Protocol
LCP and Other Control Frames	C021	PPP Link Control Protocol (LCP)
	C023	PPP Password Authentication Protocol (PAP)
	C025	PPP Link Quality Report (LQR)
	C02B	PPP Bandwidth Allocation Control Protocol (BACP)
	C02D	PPP Bandwidth Allocation Protocol (BAP)
	C223	PPP Challenge Handshake Authentication Protocol (CHAP)

PPP Field Compression

PPP uses the HDLC basic framing structure, which includes two fields that are needed in HDLC but not in PPP due to how the latter operates: the *Address* and *Control* fields. Why bother sending two bytes that have the same value for every frame and aren't used for anything? Originally they were maintained for compatibility, but this reduces efficiency.

To avoid wasting two bytes in every frame, it is possible during initial link setup using LCP for the two devices on the link to negotiate a feature called *Address and Control Field Compression (ACFC)* using the LCP option by that same name. When enabled, this feature simply causes these two fields not to be sent for most PPP frames (but not LCP control frames.) In fact, the feature would be better named “Address and Control Field ***Suppression***” because the fields are just suppressed: compressed down to nothing.

Now, even when devices agree to use field compression, they must still be capable of receiving both “compressed” and “uncompressed” frames. They differentiate one from the other by looking at the first two bytes after the initial *Flag* field. If they contain the value 0xFF03, they must be the *Address* and *Control* fields; otherwise, those fields were suppressed. (The value 0xFF03 is not a valid *Protocol* field value, so there is no chance of ambiguity.)

Similarly, it is also possible for the two devices on the link to negotiate compression of the *Protocol* field, so it takes only one byte instead of two. This is done generally by dropping the first byte if it is zero, a process called *Protocol Field Compression (PFC)*. Recall that the first byte must be even and the second odd. Thus, a receiving device examines the evenness of the first byte of the *Protocol* field in each frame. If it is odd, this means that a leading byte of zeroes in the *Protocol* field has been suppressed, because the first byte of a full two-byte *Protocol* value must be even.



Note: This “field compression” (really suppression) has nothing to do with data compression using PPP's [Compression Control Protocol \(CCP\)](#) and [compression algorithms](#).

PPP General Control Protocol Frame Format and Option Format

A general frame format is used for all of the many frame types defined in the PPP protocol suite. Within that format, the *Information* field carries either encapsulated layer-three user data, or encapsulated control messages. These control messages contain specific information that is used to configure, manage and discontinue PPP links, and to implement the various features that comprise PPP.

As we saw in previous sections, there are many different PPP control protocols, which usually can be distinguished by the word “Control” appearing their names. These include the main PPP [Link Control Protocol \(LCP\)](#), a family of [Network Control Protocols \(NCPs\)](#) such as IPCP, IPXCP and so forth, and also control protocols for implementing features, such as [CCP](#) and [ECP](#). The [authentication protocols PAP and CHAP](#) lack “Control” in the name but also fall into this category.

The control protocols each use control messages in a slightly different way, but there is also a great deal of commonality between the messages in many of them. This is because, as I explained in the topics describing the PPP protocols, most of the control protocols such as the NCP family, CCP and ECP are implemented as “subsets” of the functionality of the Link Control Protocol. They perform many of the same functions, so the PPP designers wisely “adapted” the LCP messaging system for these other control protocols.

This all means that control protocol frames have themselves a common format that fits within the overall general frame format in PPP. Even protocols like PAP and CHAP that aren't based on LCP use this general control frame format, which is described in [Table 36](#).

Table 36: PPP Control Message Format (Page 1 of 2)

Field Name	Size (bytes)	Description
Code (Type)	1	Code: A single byte value that indicates what type of control message is in this control frame. It is sometimes instead called “Type” in certain PPP standards.
Identifier	1	Identifier: This is a label field, used to match up requests with replies. When a request is sent a new <i>Identifier</i> is generated. When a reply is created, the value from the <i>Identifier</i> field in the request that prompted the reply is used for the reply's <i>Identifier</i> field.

Table 36: PPP Control Message Format (Page 2 of 2)

Field Name	Size (bytes)	Description
Length	2	Length: Specifies the length of the control frame; this is needed because the <i>Data</i> field is variable in length. The <i>Length</i> field is specified in bytes and includes all the fields in the control frame including the <i>Code</i> , <i>Identifier</i> , <i>Length</i> and <i>Data</i> fields.
Data	Variable	Data: Contains information specific to the message type. See below for more.

This entire structure becomes the payload of a PPP frame, meaning that it fits into the *Information* field of a PPP frame, as shown in [Figure 34](#). Thus, the *Length* field is equal in size to that of the *Information* field in the PPP frame. The *Protocol* field of a control frame is set to match the protocol that generated the control frame. For example, it would be 0xC021 for an LCP frame.

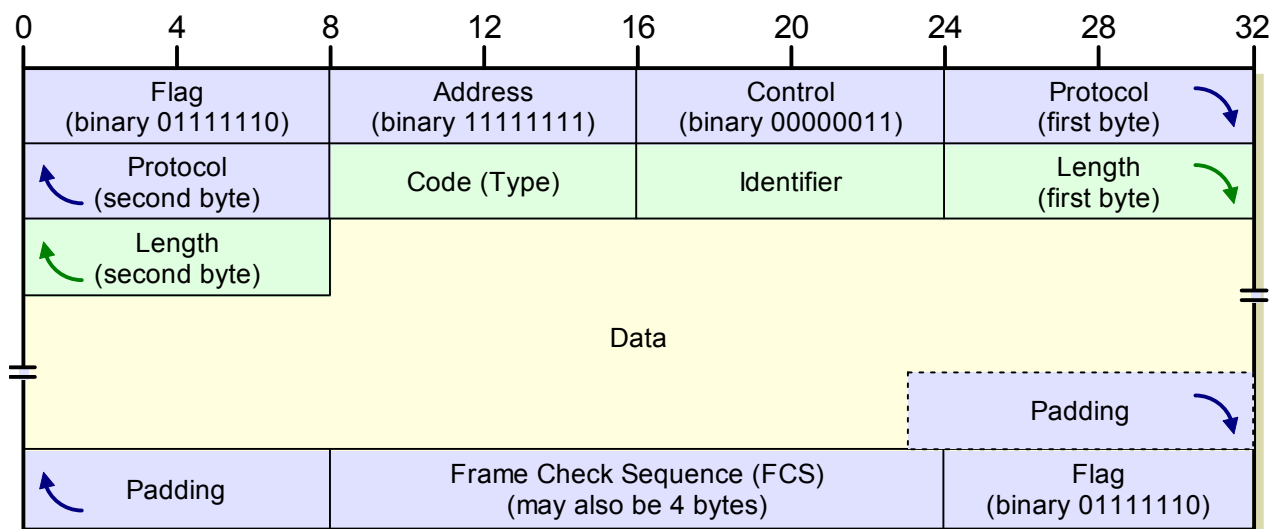

Figure 34: PPP Control Message Format

The four fields of the PPP control message format fit within the *Information* field of the PPP general frame format. The *Data* field is subsequently filled in with data specific to the control message type.

PPP Control Messages and Code Values

The *Code* field indicates the type of control frame within the particular control protocol. Some protocols have a unique set of codes used only by that particular protocol; examples include the authentication protocols (PAP and CHAP) and the [Bandwidth Allocation Protocol \(BAP\)](#). Since the NCPs and many of the feature control protocols like CCP and

ECP are based on LCP, they use a common set of message codes and types. [Table 37](#) shows these common message codes, as well as a cross-reference table indicating which control protocols use them:

Table 37: PPP Control Messages, Code Values and PPP Protocol Usage

Code Value	Control Message	LCP	NCPs	CCP and ECP
1	<i>Configure-Request</i>	✓	✓	✓
2	<i>Configure-Ack</i>	✓	✓	✓
3	<i>Configure-Nak</i>	✓	✓	✓
4	<i>Configure-Reject</i>	✓	✓	✓
5	<i>Terminate-Request</i>	✓	✓	✓
6	<i>Terminate-Ack</i>	✓	✓	✓
7	<i>Code-Reject</i>	✓	✓	✓
8	<i>Protocol-Reject</i>	✓		
9	<i>Echo-Request</i>	✓		
10	<i>Echo-Reply</i>	✓		
11	<i>Discard-Request</i>	✓		
12	<i>Identification</i>	✓		
13	<i>Time-Remaining</i>	✓		
14	<i>Reset-Request</i>			✓
15	<i>Reset-Ack</i>			✓



Note: I describe the specific ways these frame types are used in the individual topics on LCP, the NCPs, CCP and ECP.

The contents of the *Data* field depends entirely on the type of control message. In some cases, no extra data needs to be sent at all, in which case the *Data* field may be omitted. In other control messages it carries information relevant to the message type. For example, a *Code-Reject* message carries in the *Data* field a copy of the frame that was rejected.

PPP Control Message Option Format

The various *Configure-* messages are used to negotiate configuration options in LCP and the other control protocols. In their *Data* fields they carry one or more options that are, again, specific to the protocol using them. For example, LCP uses one set of configuration options for the link as a whole; CCP uses options to negotiate a compression algorithm, MP

uses it to set up multilink bundles and so on. [Figure 35](#) shows how these options, which can vary in length, are placed in the *Data* field of a PPP control message (which is in turn nested inside the general PPP frame format).

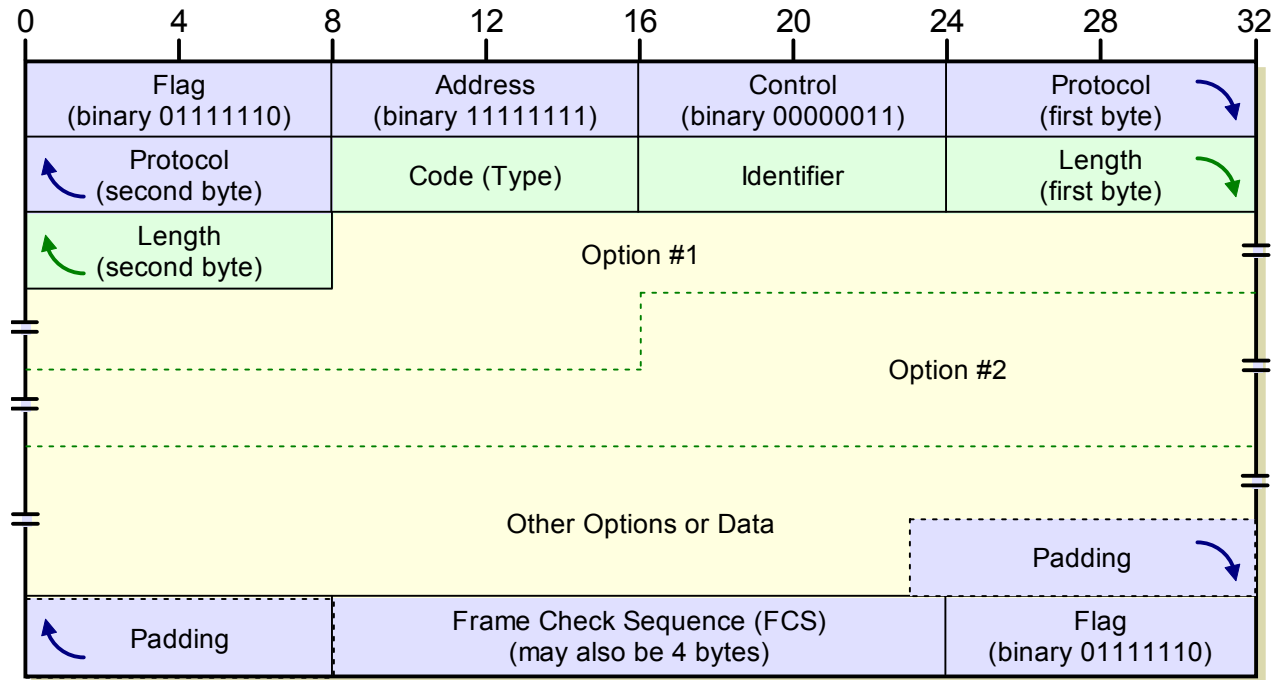

Figure 35: PPP Control Message Carrying Options

This diagram shows a sample PPP control message carrying options in its *Data* field. Any number of options can be included, and/or mixed with other data, depending on the needs of the message.

Again, there is commonality here; while every option is different, they all use the same basic format, as described in [Table 38](#) and illustrated in [Figure 36](#):

Table 38: PPP Control Message Option Format

Field Name	Size (bytes)	Description
Type	1	Type: A type value that indicates the option type. The set of <i>Type</i> values is unique to each protocol. So, for example, LCP has one set of <i>Type</i> values corresponding to its configuration options, each NCP has a different set, CCP has its own set and so on.
Length	1	Length: Specifies the length of the option in bytes.
Data	Variable	Data: Contains the specific data for the configuration option.

The configuration options are described briefly in the individual protocol topics. I am not showing the specific contents of each option as there are just too many of them. These are in the RFCs.

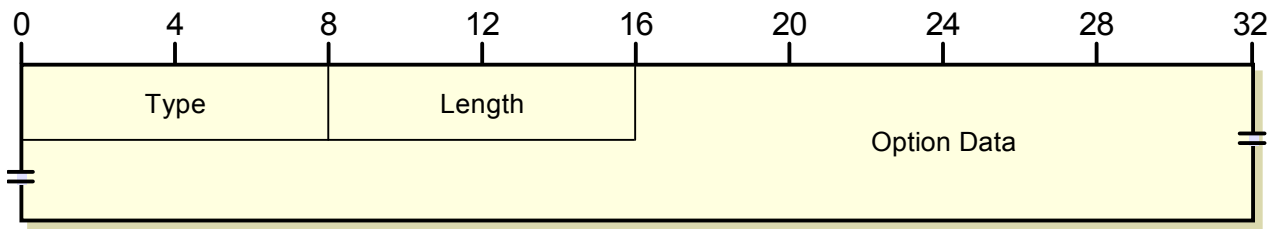

Figure 36: PPP Control Message Option Format

Each option that appears in any of the many PPP control message types consists of this triplet of Type, Length and Data.

Summary of PPP Control Message Formatting

Well now... My intention in this topic was to show you the general format used for the different control protocols since they are so similar and I don't have the time or space to describe each protocol's frames individually. I concede that this may have ended up being more confusing than enlightening, since it may be difficult to see how PPP moves from the general to the specific in its formatting. If it will help, here's a quick summary:

1. The PPP general frame format is used for all frames, including all control frames. Its *Information* field contains the payload, which carries the entire control message within it for control frames.
2. The control frame is structured using the general format I gave at the start of this topic. The *Code* value indicates the type of control frame for each control protocol. The *Data* field is variable in length, and contains data for that control frame, which in some cases may include one or more configuration options.
3. For configuration control frames like *Configure-Request* and *Configure-Ack*, the *Data* field contains an encapsulated set of options using the general structure in the second table in this topic. Each option has its own *Data* subfield that contains data specific to that option.

To help make this more clear, the next two topics provide more specific examples of frame formats for LCP and the authentication protocols.

PPP Link Control Protocol (LCP) Frame Formats

The previous topic described the general format used by the various protocols in PPP that exchange control messages. Of the many control protocols in PPP, the [Link Control Protocol \(LCP\)](#) is the most important, as it is responsible for basic PPP link setup and operation. It is also the protocol used as a “template” for many of the other control protocols.

Since it is so central to PPP, and since many of the other protocols use a similar messaging system, I want to make the general frame format seen in the previous page more “concrete” by showing the specific frame formats used for each of the LCP control frames. There are thirteen different ones, however, and since they have many fields in common, I didn't want to put here thirteen tables all of which look almost the same.

To save space and show how the messages differ, I have put them into a single large summary table instead of making thirteen smaller ones. [Table 39](#) shows the contents and meaning for each of the fields in the thirteen LCP frame types:

Table 39: PPP Link Control Protocol (LCP) Frame Types and Fields (Page 1 of 2)

Frame Type	Code Field	Identifier Field	Length Field	Data Field
Configure-Request	1	New value generated for each frame.	4 + Length of all included configuration options.	Configuration options to be negotiated by the two peers on a link. The previous topic describes the general format of configuration options.
Configure-Ack	2	Copied from the <i>Identifier</i> field of the <i>Configure-Request</i> frame for which this <i>Configure-Ack</i> is a reply.	4 + Length of all included configuration options.	Configuration options being positively acknowledged (accepted during negotiation of the link).
Configure-Nak	3	Copied from the <i>Identifier</i> field of the <i>Configure-Request</i> frame for which this <i>Configure-Nak</i> is a reply.	4 + Length of all included configuration options.	Configuration options being negatively acknowledged (renegotiation requested).
Configure-Reject	4	Copied from the <i>Identifier</i> field of the <i>Configure-Request</i> frame for which this <i>Configure-Reject</i> is a reply.	4 + Length of all included configuration options.	Configuration options being rejected (since the device cannot negotiate them).
Terminate-Request	5	New value generated for each frame.	4 (or more if extra data is included).	Not required. See note below.
Terminate-Ack	6	Copied from the <i>Identifier</i> field of the matching <i>Terminate-Request</i> .	4 (or more if extra data is included).	Not required. See note below.
Code-Reject	7	New value generated for each frame.	4 + Length of rejected frame.	A copy of the LCP frame that was rejected. This is not the complete PPP frame, just the LCP control portion from its <i>Information</i> field.
Protocol-Reject	8	New value generated for each frame.	6 + Length of rejected frame.	The first two bytes contain the <i>Protocol</i> value of the frame rejected. The rest contains a copy of the <i>Information</i> field from the frame rejected.

Table 39: PPP Link Control Protocol (LCP) Frame Types and Fields (Page 2 of 2)

Frame Type	Code Field	Identifier Field	Length Field	Data Field
<i>Echo-Request</i>	9	New value generated for each frame.	8 (or more if extra data is included).	Contains a 4-byte “magic number” used to detect looped-back links, if the appropriate configuration option has been negotiated; otherwise, set to zero. May also contain additional “uninterpreted data”; see note below.
<i>Echo-Reply</i>	10	Copied from the <i>Identifier</i> field of the matching <i>Echo-Request</i> .	8 (or more if extra data is included).	Contains a 4-byte “magic number” used to detect looped-back links, if the appropriate configuration option has been negotiated; otherwise, set to zero. May also contain additional “uninterpreted data”; see note below.
<i>Discard-Request</i>	11	New value generated for each frame.	8 (or more if extra data is included).	Contains a 4-byte “magic number” used to detect looped-back links, if the appropriate configuration option has been negotiated; otherwise, set to zero. May also contain additional “uninterpreted data”; see note below.
<i>Identification</i>	12	New value generated for each frame.	8 (or more if extra data is included).	Contains a 4-byte “magic number” used to detect looped-back links, if the appropriate configuration option has been negotiated; otherwise, set to zero. May also contain additional “uninterpreted data”; see note below.
<i>Time-Remaining</i>	13	New value generated for each frame.	12 (or more if extra data is included).	Contains a 4-byte “magic number” used to detect looped-back links, if the appropriate configuration option has been negotiated; otherwise, set to zero. Also contains a 4-byte value indicating the number of seconds remaining in the current session. A value of all ones in this field is interpreted as “forever”, meaning the session will not expire. May also contain additional “uninterpreted data”; see note below.



Note: LCP frame types 5, 6, 9, 10, 11, 12 and 13 allow an additional amount of data to be included in the *Data* field whose use is not strictly described by the protocol. The PPP standard says that this may be zero or more octets that “contains uninterpreted data for use by the sender” and “may consist of any binary value”. The inclusion of this “uninterpreted data” is left as an implementation-dependent option.

All LCP control frames are encapsulated into a PPP frame by placing the frame structure into its *Information* field [as discussed in the previous topic](#). The *Protocol* field is set to 0xC021 for LCP. For an explanation of how the frames are used, see [the operational description of LCP](#).

PPP Authentication Protocol (PAP, CHAP) Frame Formats

For links where security is important, PPP provides two optional authentication protocols. These are used during initial link setup by the Link Control Protocol (LCP) to deny PPP connections to unauthorized devices. The two authentication protocols are the [Password Authentication Protocol \(PAP\)](#) and [Challenge Handshake Authentication Protocol \(CHAP\)](#).

PAP and CHAP are control protocols and thus use the same basic control protocol frame format described earlier in this section. However, since they have a very different purpose than LCP and many of the other control protocols, they use a distinct set of frames, with their own unique set of *Code* values. I thought it might be useful to see how PAP and CHAP frames are constructed. PAP uses three different control frame types, and CHAP uses four. To save space and show how the frames compare to each other, I will show them in one table for each protocol instead of seven tables.

PPP PAP Control Frame Formats

Let's start with PAP. Its three control frames are constructed as shown in [Table 40](#). The *Authenticate-Request* uses one format, illustrated in [Figure 37](#), while the other two frame types use a different format, shown in [Figure 38](#).

Table 40: PPP Password Authentication Protocol (PAP) Frame Formats

Frame Type	Code Field	Identifier Field	Length Field	Data Field															
<i>Authenticate-Request</i>	1	New value generated for each frame.	6 + Length of <i>Peer-ID</i> + Length of <i>Password</i>	<p>Contains the "user name" and password for authentication. This is carried in four subfields arranged as follows:</p> <table border="1"> <thead> <tr> <th>Subfield Name</th> <th>Size (bytes)</th> <th>Description</th> </tr> </thead> <tbody> <tr> <td><i>Peer-ID Length</i></td> <td>1</td> <td><i>Peer-ID Length</i>: Length of the <i>Peer-ID</i> field, in bytes.</td> </tr> <tr> <td><i>Peer-ID</i></td> <td>Variable</td> <td><i>Peer-ID</i>: The name of the device to be authenticated; equivalent in concept to a "user name".</td> </tr> <tr> <td><i>Passwd-Length</i></td> <td>1</td> <td><i>Password Length</i>: Length of the <i>Password</i> field, in bytes.</td> </tr> <tr> <td><i>Password</i></td> <td>Variable</td> <td><i>Password</i>: The password corresponding to the name being authenticated.</td> </tr> </tbody> </table>	Subfield Name	Size (bytes)	Description	<i>Peer-ID Length</i>	1	<i>Peer-ID Length</i> : Length of the <i>Peer-ID</i> field, in bytes.	<i>Peer-ID</i>	Variable	<i>Peer-ID</i> : The name of the device to be authenticated; equivalent in concept to a "user name".	<i>Passwd-Length</i>	1	<i>Password Length</i> : Length of the <i>Password</i> field, in bytes.	<i>Password</i>	Variable	<i>Password</i> : The password corresponding to the name being authenticated.
Subfield Name	Size (bytes)	Description																	
<i>Peer-ID Length</i>	1	<i>Peer-ID Length</i> : Length of the <i>Peer-ID</i> field, in bytes.																	
<i>Peer-ID</i>	Variable	<i>Peer-ID</i> : The name of the device to be authenticated; equivalent in concept to a "user name".																	
<i>Passwd-Length</i>	1	<i>Password Length</i> : Length of the <i>Password</i> field, in bytes.																	
<i>Password</i>	Variable	<i>Password</i> : The password corresponding to the name being authenticated.																	
<i>Authenticate-Ack</i>	2	Copied from the <i>Identifier</i> field of the <i>Authenticate-Request</i> frame for which this is a reply.	5 + Length of included <i>Message</i> .	Contains a one-byte <i>Msg-Length</i> subfield that specifies the length of the <i>Message</i> subfield that follows it. The <i>Message</i> subfield contains an arbitrary string of data whose use is implementation dependent. It may be used to provide an indication of authentication success or failure to the user. If not used, the <i>Msg-Length</i> field is still included, but its value is set to zero.															
<i>Authenticate-Nak</i>	3																		

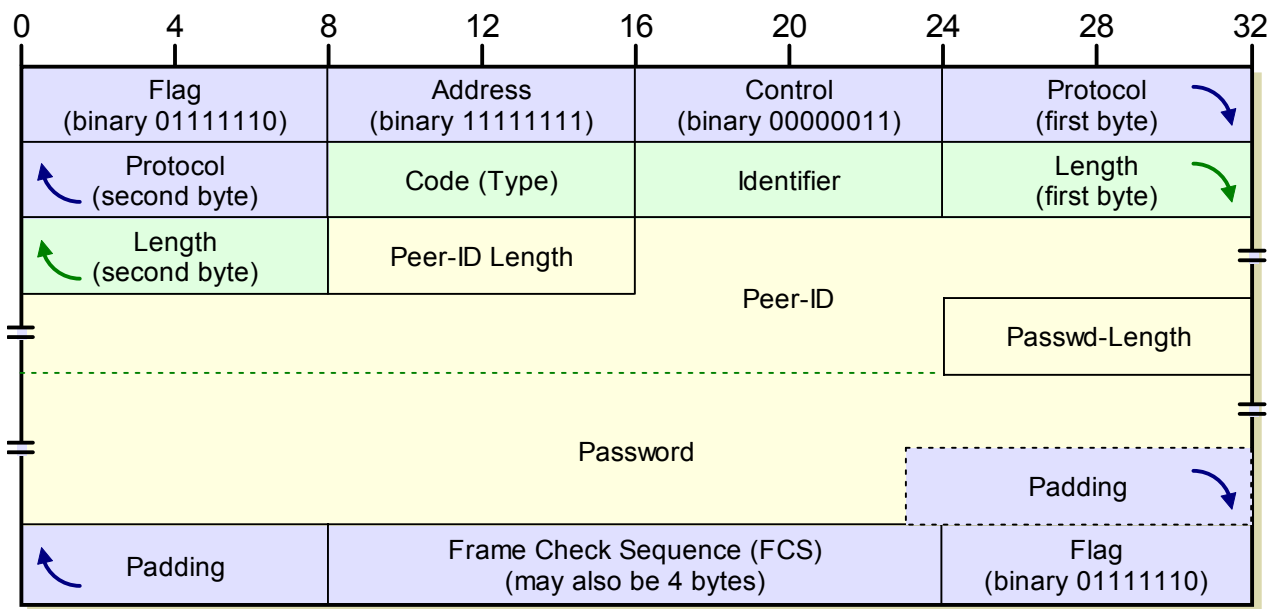

Figure 37: PPP PAP Authenticate-Request Frame Format

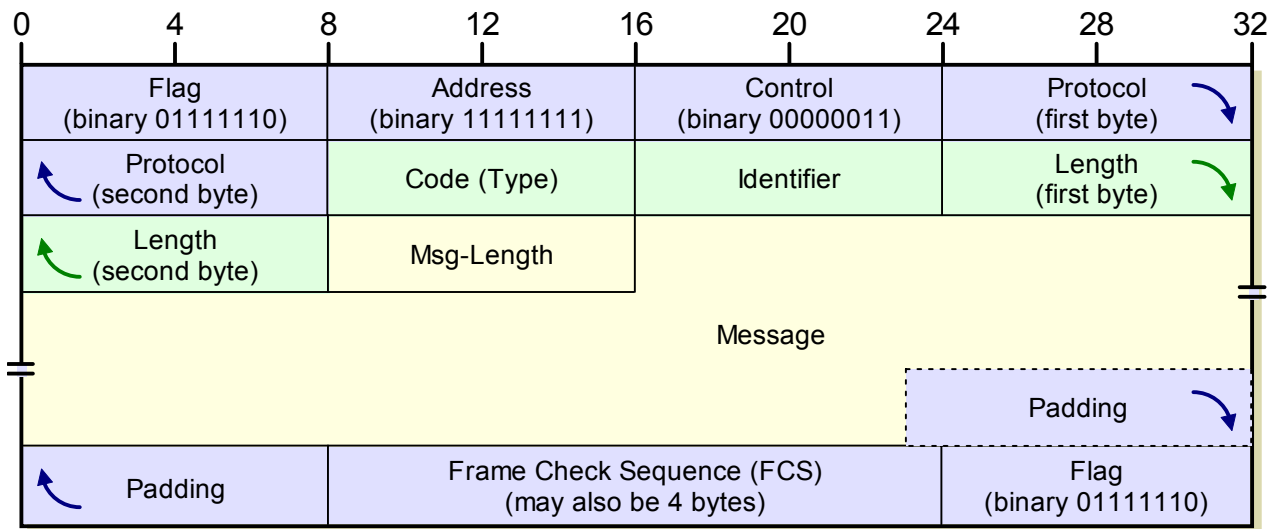

Figure 38: PPP PAP Authenticate-Ack and Authenticate-Nak Frame Format

PPP CHAP Control Frame Formats

The four CHAP frame types are formatted as shown in [Table 41](#). As you can see in that table, the *Challenge* and *Response* frames use one message format, illustrated in [Figure 39](#), while *Success* and *Failure* frames use a different one, shown in [Figure 40](#).

Table 41: PPP Challenge Handshake Authentication Protocol (CHAP) Formats

Frame Type	Code Field	Identifier Field	Length Field	Data Field												
Challenge	1	New value generated for each frame.	5 + Length of challenge text + Length of name	Carries the challenge text or response text, and a system identifier. This information is carried in three subfields: <table border="1" style="margin: 10px auto;"> <thead> <tr> <th>Subfield Name</th> <th>Size (bytes)</th> <th>Description</th> </tr> </thead> <tbody> <tr> <td>Value-Size</td> <td>1</td> <td>Value-Size: Length of the <i>Value</i> subfield that follows, in bytes.</td> </tr> <tr> <td>Value</td> <td>Variable</td> <td>Value: For a Challenge frame, contains the challenge text used in the initial “challenge”. For a Response frame, the encrypted challenge text being returned to the authenticator.</td> </tr> <tr> <td>Name</td> <td>Variable</td> <td>Name: One or more bytes of text used to identify the device that sent the frame.</td> </tr> </tbody> </table>	Subfield Name	Size (bytes)	Description	Value-Size	1	Value-Size: Length of the <i>Value</i> subfield that follows, in bytes.	Value	Variable	Value: For a Challenge frame, contains the challenge text used in the initial “challenge”. For a Response frame, the encrypted challenge text being returned to the authenticator.	Name	Variable	Name: One or more bytes of text used to identify the device that sent the frame.
Subfield Name	Size (bytes)	Description														
Value-Size	1	Value-Size: Length of the <i>Value</i> subfield that follows, in bytes.														
Value	Variable	Value: For a Challenge frame, contains the challenge text used in the initial “challenge”. For a Response frame, the encrypted challenge text being returned to the authenticator.														
Name	Variable	Name: One or more bytes of text used to identify the device that sent the frame.														
Response	2	Copied from the <i>Identifier</i> field of the <i>Challenge</i> frame for which this is a reply.	5 + Length of <i>Value</i> + Length of <i>Name</i>													
Success	3	Copied from the <i>Identifier</i> field of the <i>Response</i> frame for which this is a reply.	4 (or more if extra data is included).	May contain an arbitrary, implementation-dependent <i>Message</i> field to indicate to the user whether authentication was successful or failed.												
Failure	4															

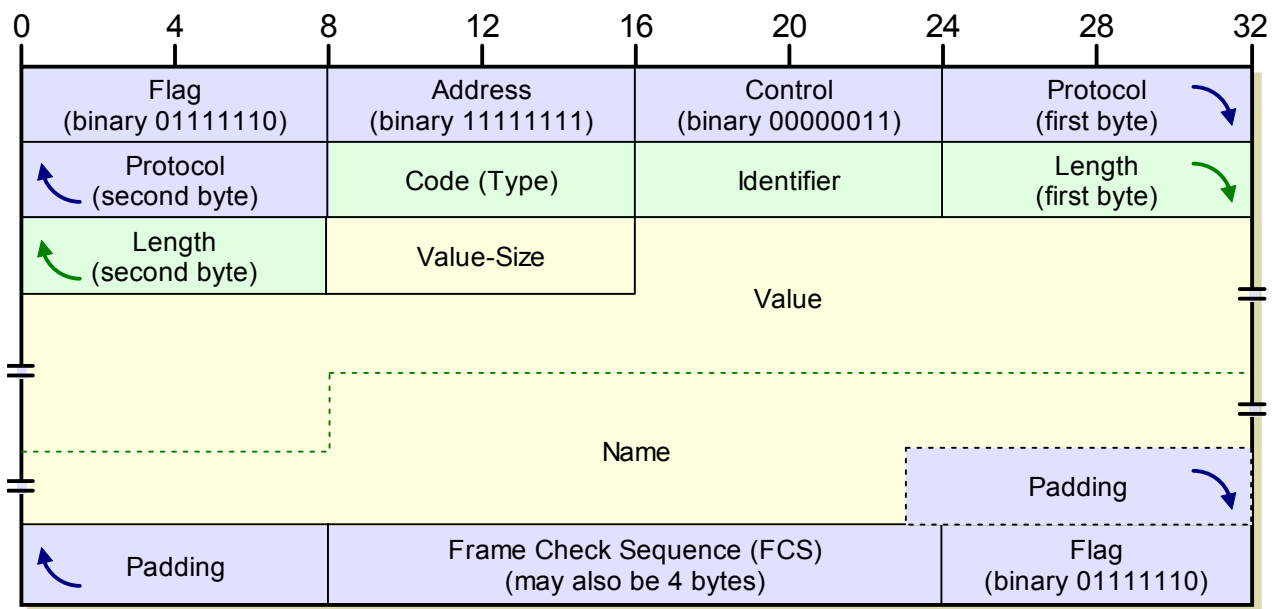

Figure 39: PPP CHAP Challenge and Response Frame Format

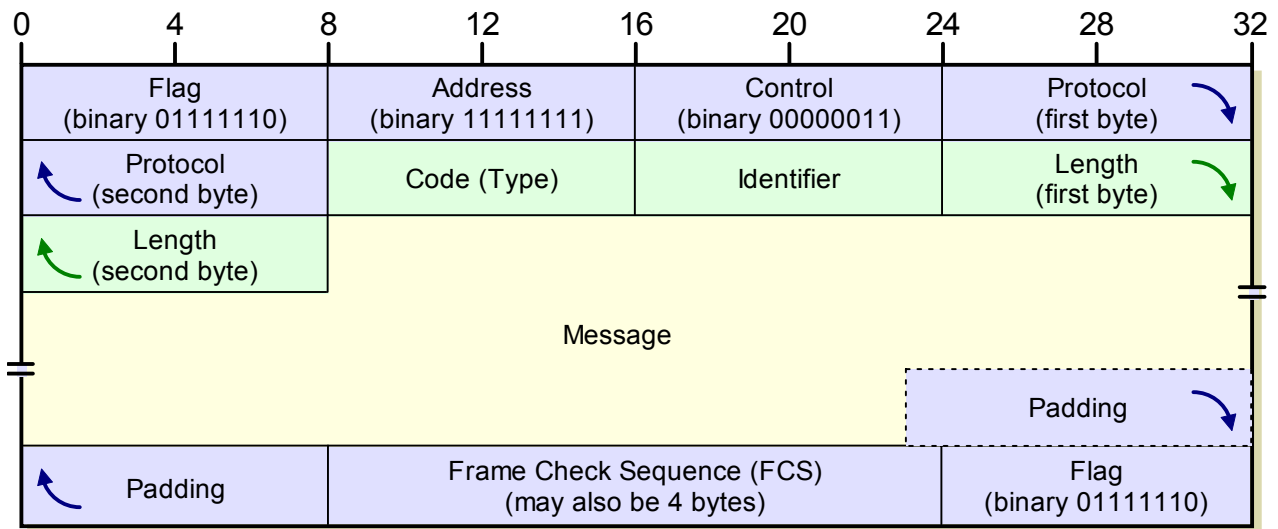

Figure 40: PPP CHAP Success and Failure Frame Format

PPP Multilink Protocol (MP) Frame Format

Some devices are connected not by a single physical layer link but by two or more. These may be either multiple physical connections such as two connected pairs of modems, or multiplexed virtual layer one connections like ISDN B channels. In either case, the PPP

Multilink Protocol (MP, which also goes by several aliases such as MLPPP and MLP) can be used to aggregate the bandwidth of these physical links to create a single, high-speed *bundle*. I describe how this is done in the [operational topic on MP](#).

Table 42: PPP Multilink Protocol Fragment Frame Format

Field Name	Size (bytes)	Description
B	1/8 (1 bit)	Beginning Fragment Flag: When set to 1, flags this fragment as the first of the split-up PPP frame. It is set to 0 for other fragments.
E	1/8 (1 bit)	Ending Fragment Flag: When set to 1, flags this fragment as the last of the split-up PPP frame. It is set to 0 for other fragments.
Reserved	2/8 (2 bits) OR 6/8 (6 bits)	Reserved: Not used, set to zero.
Sequence Number	1 1/2 (12 bits) OR 3 (24 bits)	Sequence Number: When a frame is split up, the fragments are given consecutive sequence numbers so the receiving device can properly reassemble them.
Fragment Data	Variable	Fragment Data: The actual fragment from the original PPP frame.

After MP is configured and starts working, it operates by employing a strategy for dividing up regular PPP frames amongst the many individual physical links that comprise the MP bundle. This is usually accomplished by chopping up the PPP frames into pieces called *fragments* and spreading these fragments across the physical links. This allows the traffic on the physical links to be easily balanced.

PPP Multilink Protocol Frame Fragmentation Process

To accomplish this fragmentation process, a three step process is followed:

1. **Original PPP Frame Creation:** The data or other information to be sent is first formatted as a “whole” PPP frame, but in a modified form, as described below.
2. **Fragmentation:** The full-sized PPP frame is chopped into fragments by MP.
3. **Encapsulation:** Each fragment is encapsulated in the *Information* field of a new PPP MP fragment frame, along with control information to allow the fragments to be reassembled by the recipient.

Several of the fields that normally appear in a “whole” PPP frame aren’t needed if that frame is going to then be divided and placed into other PPP Multilink frames, so when fragmentation is to occur, they are omitted when the original PPP frame is constructed for efficiency’s sake. Specifically:

- ☉ The *Flag* fields at the start and end are used only for framing for transmission and aren’t needed in the logical frame being fragmented.
- ☉ The *FCS* field is not needed, because each fragment has its own *FCS* field.

- ☉ The special “compression” options that are possible for any PPP frame are used when creating this original frame: **Address and Control Field Compression (ACFC)** and **Protocol Field Compression (PFC)**. This means that there are no *Address* or *Control* fields in the frame, and the *Protocol* field is only one byte in size. Note that this inherently restricts fragments to carrying only certain types of information.

These changes save a full eight bytes on each PPP frame to be fragmented. As a result, the original PPP frame has a very small header, consisting of only a one-byte *Protocol* field. The *Protocol* value of each fragment is set to 0x003D to indicate a MP fragment, while the *Protocol* field of the original frame becomes the first byte of “data” in the first fragment.



Key Concept: The PPP Multilink Protocol normally divides data amongst physical links by creating an original PPP frame with unnecessary headers removed, and then dividing it into fragment frames. Each fragment includes special headers to allow reassembly of the original frame by the recipient device.

PPP Multilink Protocol Fragment Frame Format

The *Information* field of each fragment uses a substructure that contains a four-field *MP header* along with one fragment of the original PPP frame, as shown in Table 42.

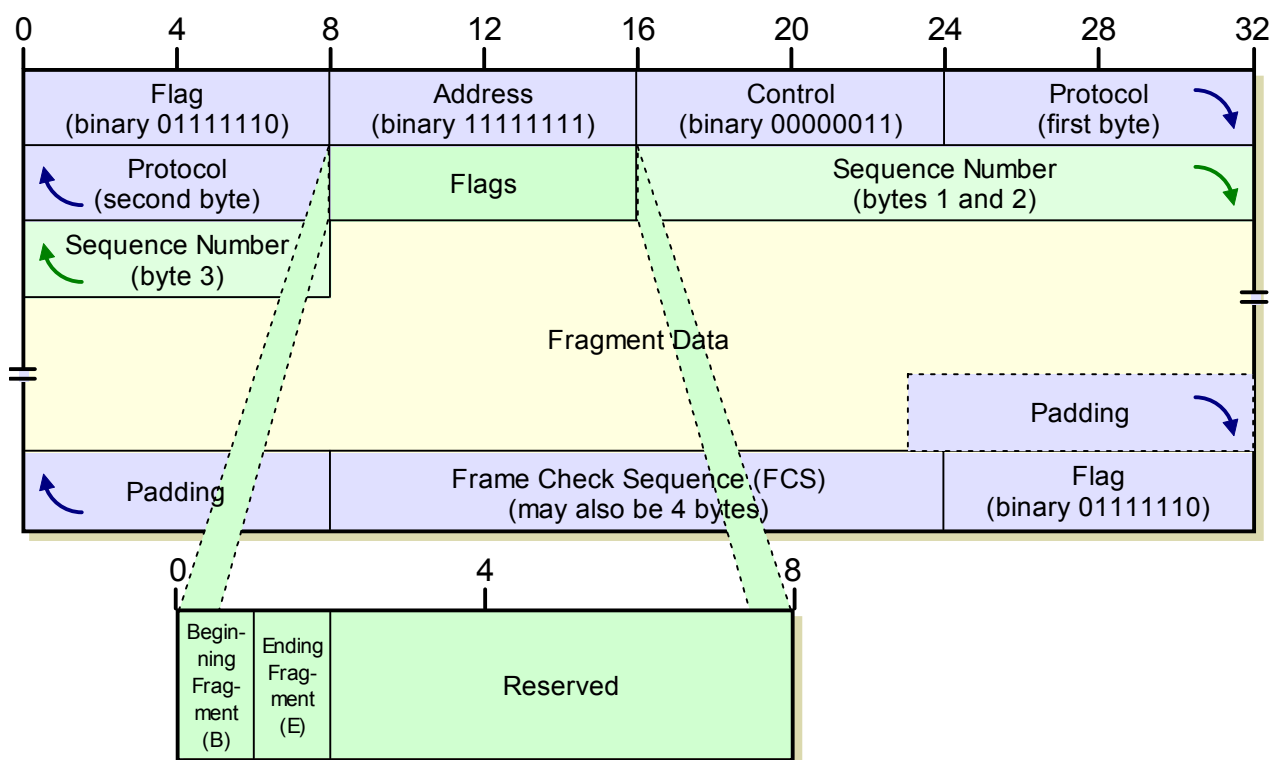

Figure 41: PPP Multilink Protocol Long Fragment Frame Format

The long PPP Multilink Protocol frame format uses a full byte for flags and a 24-bit *Sequence Number*.

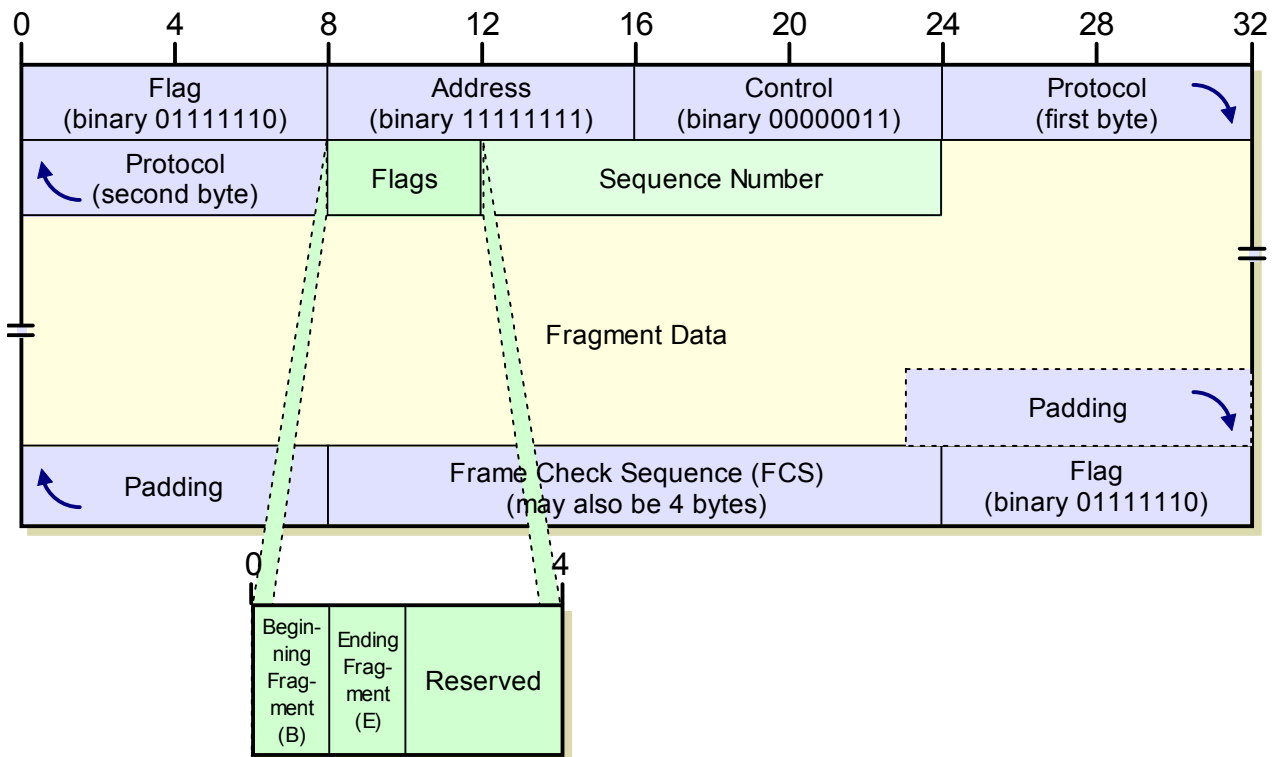

Figure 42: PPP Multilink Protocol Short Fragment Frame Format

The short version of the PPP Multilink Protocol format uses 4 bits for flags and a 12-bit *Sequence Number*.

As you can see, the MP frame format comes in two versions: the long format uses a 4-byte header, while the short format requires only 2 bytes. The default MP header format uses a 24-bit *Sequence Number* and has 6 reserved bits, as shown in [Figure 41](#). It is possible when MP is set up, for devices to negotiate the *Multilink Short Sequence Number Header Format* configuration option. If this is done successfully, shorter 12-bit *Sequence Numbers* are used instead. Four of the reserved bits are also truncated, to save 2 bytes on each frame, as illustrated in [Figure 42](#). (Considering that 12 bits still allows for over 4,000 fragments per PPP frame, this is usually more than enough!)

The *Fragment Data* field contains the actual fragment to be sent. Since the original PPP header (including the *Protocol* field) is at the start of the original PPP frame, this will appear at the start of the first fragment. The remaining fragments will have just portions of the *Information* field of the original PPP frame. The last fragment will end with the last bytes of the original PPP frame.

The receiving device will collect all the fragments for each PPP frame, extract the fragment data and MP headers from each. It will use the *Sequence Numbers* to reassemble the fragments and then process the resulting PPP frame.

PPP Multilink Protocol Fragmentation Demonstration

A demonstration of fragmenting a PPP data frame can be seen in [Figure 43](#). At top is the same PPP data frame shown in [Figure 33](#). The eight bytes grayed out are the ones not used when a frame is to be fragmented. Thus, the PPP frame used for MP is 24 bytes long, as seen in the smaller table at left (note that the eight bytes are not created and removed, I just showed them in the upper table for illustration). This frame is split into 8-byte chunks, each carried in the *Fragment Data* fields of an MP fragment. Note the consecutive *Sequence Number* (“Seq”) values in the fragment frames. Also, note that the *Beginning Fragment* field is set only for the first fragment, and the *Ending Fragment* only for the last one.

Flag = 7E	Address = FF	Control = 03	Protocol (byte 1) = 00
Protocol (byte 2) = 21	2A	00	1D
47	9F	BC	19
88	18	E5	01
73	A3	69	AF
1B	90	54	BA
00	7C	D1	AA
Padding = 00	Frame Check Sequence = ????		Flag = 7E

0	8	16	24	32
21	2A	00	1D	
47	9F	BC	19	
88	18	E5	01	
73	A3	69	AF	
1B	90	54	BA	
00	7C	D1	AA	

Original PPP Frame

Flag = 7E	Addr = FF	Ctrl = 03	Prot1 = 00
Prot1 = 3D	1	0	Seq = 0C1
2A	00	1D	47
9F	BC	19	Pad = 00
Pad = 00	FCS = ????		Flag = 7E

PPP Multilink Frame #1 (bytes 1 to 8)

Flag = 7E	Addr = FF	Ctrl = 03	Prot1 = 00
Prot1 = 3D	0	0	Seq = 0C2
18	E5	01	73
A3	69	AF	Pad = 00
Pad = 00	FCS = ????		Flag = 7E

PPP Multilink Frame #2 (bytes 9 to 16)

Flag = 7E	Addr = FF	Ctrl = 03	Prot1 = 00
Prot1 = 3D	0	1	Seq = 0C3
90	54	BA	00
7C	D1	AA	Pad = 00
Pad = 00	FCS = ????		Flag = 7E

PPP Multilink Frame #3 (bytes 17 to 24)

Figure 43: PPP Multilink Protocol (MP) Fragmentation Demonstration

This diagram shows how a single PPP frame is fragmented into three smaller ones, and how the control fields are set for each fragment.



TCP/IP Network Interface / Internet "Layer Connection" Protocols

The second layer of the [OSI Reference Model](#) is the [data link layer](#); it corresponds to the [TCP/IP network interface layer](#). It is there that most LAN, WAN and WLAN technologies are defined, such as Ethernet and IEEE 802.11. The third layer is the [network layer](#), also called the internet layer in the TCP/IP model, where internetworking protocols are defined, the most notable being the [Internet Protocol](#). These two layers are intimately related, because messages sent at the network layer must be carried over individual physical networks at the data link layer. They perform different tasks but as neighbors in the protocol stack, must cooperate with each other.

There is a set of protocols that serves the important task of linking together these two layers and allowing them to work together. The problem with them is deciding where exactly they should live! They are sort of the “black sheep” of the networking world—nobody denies their importance, but they always think they belong in “the other guy's” layer. For example, since these protocols pass data on layer two networks, the folks who deal with layer two technologies say they belong at layer three. But those who work with layer three protocols consider these “low level” protocols that provide services to layer three, and hence put them as part of layer two.

So where do they go? Well, to some extent it doesn't really matter. Even if they are “black sheep” I consider them somewhat special, so I gave them their own home. Welcome to “networking layer limbo”, also known as “OSI layer two-and-a-half”. ☺ This is where a couple of protocols are described that serve as “glue” between the data link and network layers. The main job performed here is address resolution, or providing mappings between layer two and layer three addresses. This resolution can be done in either direction, and is represented by the two TCP/IP protocols ARP and RARP (which, despite their similarities, are used for rather different purposes in practice.)



Background Information: I suggest familiarity with the basics of [layer two](#) and [layer three](#) before proceeding here. In particular, some understanding of [IP addressing](#) is helpful, though not strictly necessary. In general, if you are going to read about IP anyway, you would be better off covering that material before proceeding to this section.

Address Resolution and the TCP/IP Address Resolution Protocol (ARP)

Communication on an internetwork is accomplished by sending data at layer three using a network layer address, but the actual transmission of that data occurs at layer two using a data link layer address. This means that every device with a fully-specified networking protocol stack will have both a layer two and a layer three address. It is necessary to define some way of being able to link these addresses together. Usually, this is done by taking a network layer address and determining what data link layer address goes with it. This process is called *address resolution*.

In this section I look at the problem of address resolution at both a conceptual and practical level, with a focus on how it is done in the important [TCP/IP protocol suite](#). I begin with a section that overviews address resolution in general terms and describes the issues involved in the process. I then describe the TCP/IP Address Resolution Protocol (ARP), probably the best-known and most commonly used address resolution technique. I also provide a brief overview of how address resolution is done for multicast addresses in IP, and the method used in the new IP version 6.

Address Resolution Concepts and Issues

Due to the prominence of TCP/IP in the world of networking, most discussions of address resolution jump straight to the [TCP/IP Address Resolution Protocol \(ARP\)](#). This protocol is indeed important, and we will take a look at it in the next section. However, the basic problem of address resolution is not unique to any given implementation that deals with it, such as TCP/IP's ARP. To provide better understanding of resolving addresses between the data link layer and the network layer and to support for our examination of ARP, I think it's a good idea to start by looking at the matter in more general terms.

To that end, I provide here some background information on address resolution, exploring various concepts and issues related to the technique in general terms. I begin by discussing the need for address resolution in general terms. I then describe the two main methods for solving the address resolution problem: direct mapping and dynamic resolution. I also discuss some of the efficiency issues involved in practical dynamic address resolution, with a focus on the importance of caching.

The Need For Address Resolution

I can imagine that some people might balk at the notion of address resolution and the need for protocols that perform this function. In my chapter on the [OSI Reference Model](#) I talked extensively about how the whole point of having conceptual layers was to separate logical functions and allow higher-layer protocols to be hidden from lower-layer details. Given this, why do we need address resolution protocols that tie protocols and layers together?

I did say that layers are distinct, true. However, I also tried to make the point that the OSI Reference Model is exactly that—a *model*. There are often practicalities that arise that require solutions that don't strictly fit the layer model. [When the model doesn't fit reality, the model must yield](#). And so it is in dealing with the problem of address resolution.

Addressing at Layer Two and Layer Three

When we consider the seven layers of the OSI Reference Model, there are two that deal with addressing: the data link layer and the network layer. The physical layer is not strictly concerned with addressing at all, only sending at the bit level. The layers above the network layer all work with network layer addresses.

So the next obvious question is: why is addressing done at two different layers? The answer is that they are very different types of addresses that are used for different purposes. Layer two addresses (such as IEEE 802 MAC addresses) are used for local transmissions between hardware devices that can communicate directly. They are used to implement basic LAN, WLAN and WAN technologies. In contrast, layer three addresses (most commonly [Internet Protocol or IP addresses](#)) are used in internetworking, to create the equivalent of a massive “virtual” network at the network layer.

The most important distinction between these types of addresses is the distinction between layers two and three themselves: layer two deals with directly-connected devices (on the same network) while layer three deals with *indirectly*-connected devices (as well as directly-connected). Say, for example, you want to connect to the Web server at <http://www.tcpipguide.com>. This is a web site that runs on a server that has an Ethernet card in it for connecting it to its Internet service provider site. However, even if you know its MAC address, you cannot use it to talk directly to this server using the Ethernet card in your home PC, because the devices are on different networks—in fact, they may be on different continents!

Instead, you communicate at layer three, using the [Internet Protocol](#) and higher layer protocols such as [TCP](#) and [HTTP](#). Your request is *routed* from your home machine, through a sequence of routers, to the server at The TCP/IP Guide, and the response is routed back to you. The communication is, logically, at layers three and above; you send the request not to the MAC address of the server's network card, but rather to the server's IP address.

However, while we can *virtually* connect devices at layer three, these connections are really conceptual only. When you send a request using IP, it is sent one *hop* at a time, from one physical network to the next. At each of these hops, an actual transmission occurs at the physical and data link layers. When your request is sent to your local router at layer three, the actual request is encapsulated in a frame using whatever method you physically connect to the router, and passed to it using the router's data link layer address. The same happens for each subsequent step, until finally, the router nearest the destination sends to the destination using its data link (MAC) address. This is illustrated in [Figure 44](#).

Converting Layer Three Addresses to Layer Two: Address Resolution

The basic problem is that IP addresses are *too high level* for the physical hardware on networks to deal with; they don't understand what they are. When your request shows up at the router that connects to The TCP/IP Guide, it can see the <http://www.tcpipguide.com> server's IP address, but that isn't helpful: it needs to send to server's **MAC address**.

The identical issue exists even with communication between devices on a LAN. Even if the Web server is sitting on the same desk as the client, the communication is logically at the IP layer, but must also be accomplished at the data link layer. This means we need a way of translating between the addresses at these two layers. This process is called *address resolution*.



Key Concept: Address resolution is required because internetworked devices communicate logically using layer three addresses, but the actual transmissions between devices take place using layer two (hardware) addresses.

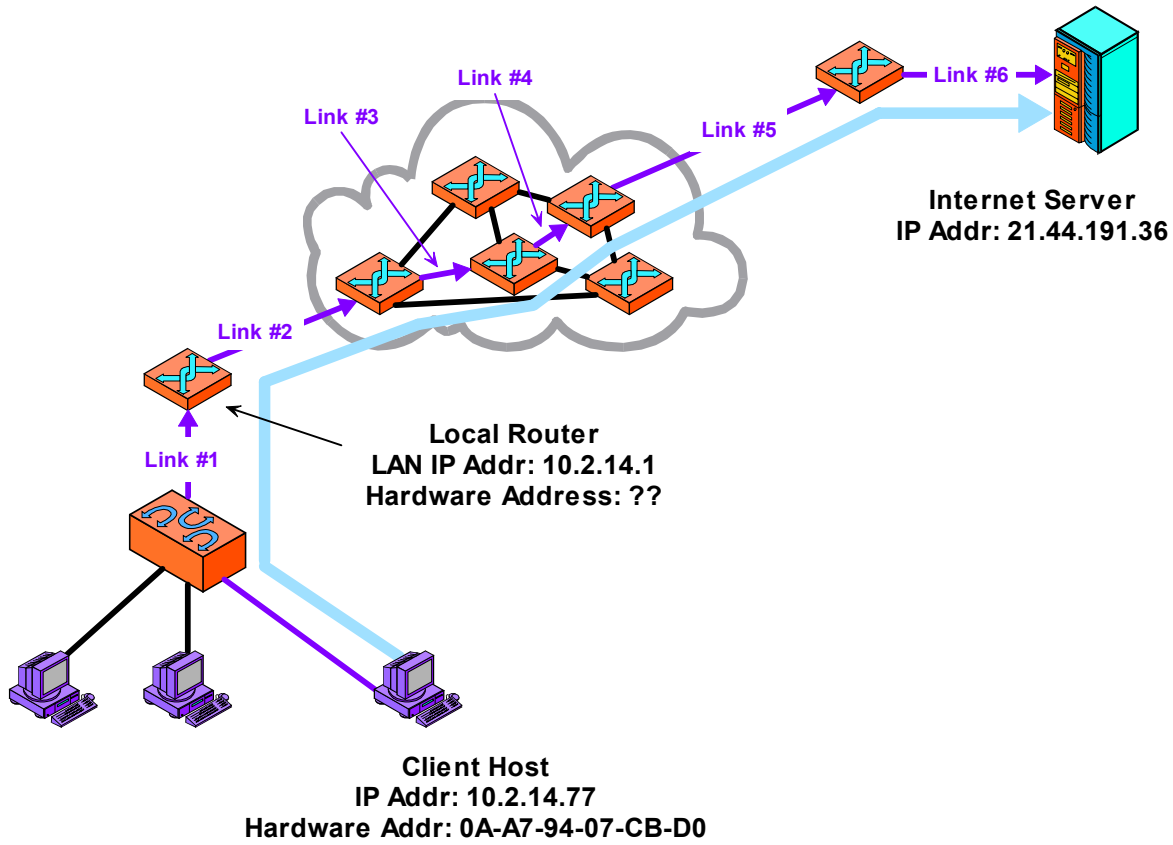

Figure 44: Why Address Resolution Is Necessary

In this example, a client on the local network is accessing a server somewhere on the Internet. Logically, this connection can be made “directly” between the client and server, but in reality it is a sequence of physical links at layer two. In this case there are six such links, most of them between routers that lie between the client and server. At each step the decision of where to send the data is made based on a layer three address, but the actual transmission must be performed using the layer two address of the next intended recipient in the route.

General Address Resolution Methods

In fact, not only do we need to have way of making this translation, we need to be concerned with the manner in which it is done. Since the translation occurs for each hop of every datagram sent over an internetwork, the efficiency of the process is extremely important. We don't want to use a resolution method that takes a lot of network resources.

Address resolution can be accomplished in two basic ways:

- ☉ **Direct Mapping:** A formula is used to map the higher-layer address into the lower-layer address. This is the simpler and more efficient technique but has some limitations, especially regarding the size of the data link layer address compared to the network layer address.

-
- ④ **Dynamic Resolution:** A special protocol is used that allows a device with only an IP address to determine the corresponding data link layer address, even if they take completely different forms. This is normally done by interrogating one or more other devices on a local network to determine what data link layer address corresponds to a given IP address. This is more complex and less efficient than direct mapping but is more flexible.

The next two topics explore these two methods in more detail.

You should bear in mind that of necessity, it is not possible to have a fully general address resolution method that works automatically. Since it deals with linking data link layer addresses to network layer addresses, the implementation must be specific to the technologies used in each of these layers. The only method that could really be considered generic would be the use of static, manually-updated tables that say “link this layer three address to this layer two address”. This, of course, is not automatic and brings with it all the limitations of manual configuration.

Address Resolution Through Direct Mapping

Network layer addresses must be resolved into data link layer addresses numerous times during the travel of each datagram across an internetwork. We therefore want the process to be as simple and efficient as possible. The easiest method of accomplishing this is to do *direct mapping* between the two types of addresses.

The basic idea behind direct mapping is to choose a scheme for layer two and layer three addresses so that you can determine one from the other using a simple algorithm. This enables you to take the layer three address, and follow a short procedure to convert it into a layer two address. In essence, whenever you have the layer three address you already have the layer two address.

The simplest example of direct mapping would be if we used the same structure and semantics for both data link and network layer addresses. This is generally impractical, because the two types of addresses serve different purposes, and are therefore based on incompatible standards. However, we can still perform direct mapping if we have the flexibility of creating layer three addresses that are large enough to encode a complete data link layer address within them. Then, determining the layer two address is a simple matter of selecting a certain portion of the layer three address.

As an example, consider a simple LAN technology like ARCNet. It uses a short 8-bit data link layer address, with valid values of 1 to 255, which can be assigned by an administrator. We could easily set up an IP network on such a LAN by taking a [class C](#) (or /24) network and using the ARCNet data link layer as the last octet. So, if our network were, for example, 222.101.33.0/24, we could assign the device with ARCNet address #1 the IP address 222.101.33.1, the device with ARCNet address #29 would be 222.101.33.29 and so forth, as shown in [Figure 45](#).

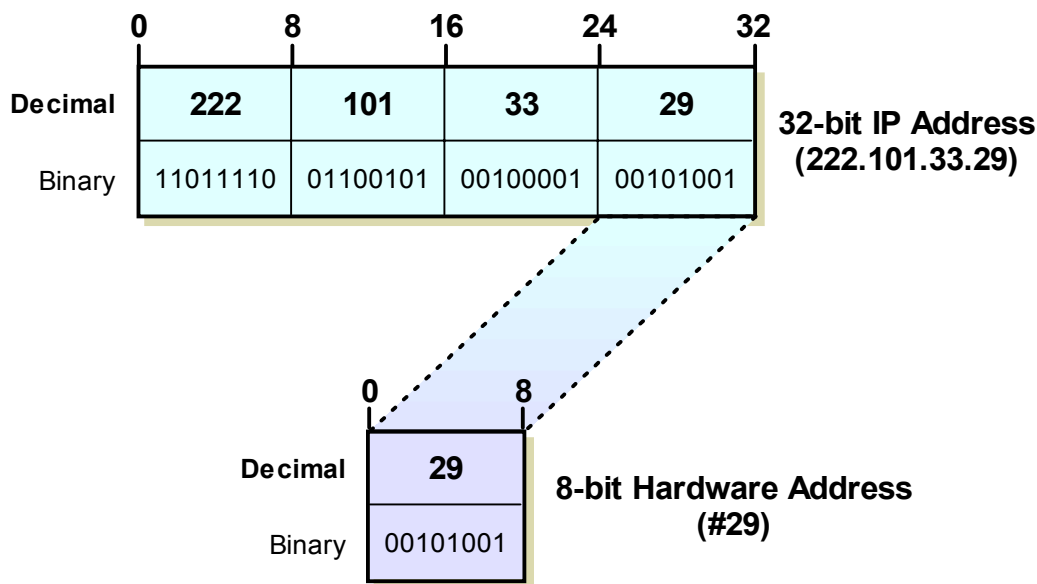

Figure 45: Address Resolution Through Direct Mapping

When the hardware address is small, it is easy to define a mapping that directly corresponds to a portion of a layer three address. In this example, an 8-bit MAC address, such as that used for ARCNet, is mapped to the last byte of the device’s IP address, making address resolution a trivial matter.

The appeal of this system is obvious. Conceptually, it is trivially simple to understand—to get the hardware address for a device, you just use the final eight bits of the IP address. It’s also very simple to program devices to perform, and highly efficient, requiring no exchange of data on the network at all.



Key Concept: When the layer two address is smaller than the layer three address, it is possible to define a direct mapping between them, so that the hardware address can be determined directly from the network layer address. This makes address resolution extremely simple, but reduces flexibility in how addresses are assigned.

Direct Mapping Not Possible With Large Hardware Addresses

Unfortunately, direct mapping only works when it is possible to express the data link layer address as a function of the network layer address. Consider instead the same IP address, 222.101.33.29, running on an Ethernet network. Here, the data link layer addresses are “hard-wired” into the hardware itself (they can sometimes be overridden but usually this is not done). More importantly, the MAC address is 48 bits wide, not 8. This means the layer two address is bigger than the layer three address, and there is no way to do direct mapping, as [Figure 46](#) illustrates.

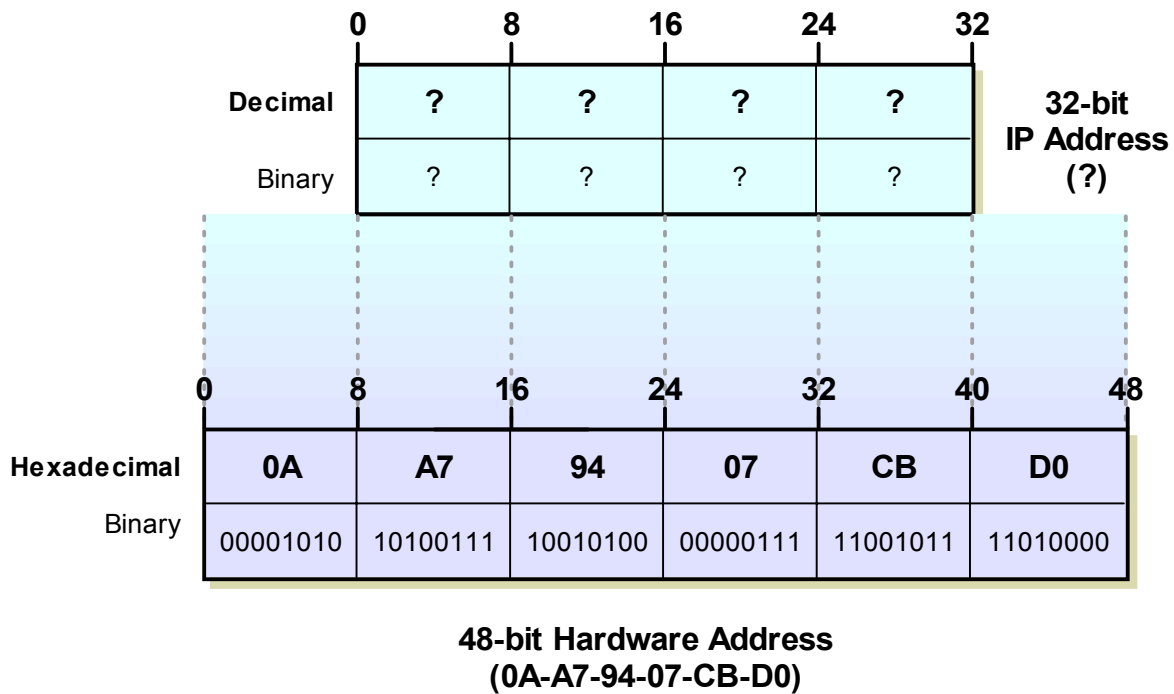

Figure 46: Address Resolution Problems With Large Hardware Address Size

When the layer two address is larger in size than the layer three address, it is not possible to define a mapping between them that can be used for address resolution.



Note: In the case where the hardware address size exceeds the network layer address size, we could do a “partial mapping”. For example, we could use the IP address to get *part* of the MAC address and hope we don’t have duplication in the bits we didn’t use. This method is not well-suited to regular transmissions, but is in fact used for resolving *multicast* addresses in IPv4 to Ethernet addresses.

In general, then, direct mapping is not possible when the layer three address is smaller than the layer two address. Consider that Ethernet is the most popular technology at layer two and uses a **48-bit address**, and IP is the most popular technology at layer three and uses a 32-bit address. This is one reason why direct mapping is a technique that is not only not widely used, but that most people don’t know about!

Inflexibility of Direct Mapping

Now let’s consider the next generation, **IP version 6?** IPv6 supports massive 128-bit addresses. Furthermore, regular (unicast) addresses are even defined using a method that creates them from data link layer addresses using a special mapping. This would in theory allow IPv6 to use direct mapping for address resolution.

However, the decision was made to have IPv6 use dynamic resolution just as IPv4 does. One reason might be historical, since IPv4 uses dynamic resolution. However, the bigger reason is probably due to a disadvantage of direct mapping: its inflexibility. [Dynamic resolution](#) is a more generalized solution, because it allows data link layer and network layer addresses to be independent, and its disadvantages can be mostly neutralized through careful implementation, as we will see.

In fact, evidence for this can be seen in the fact that dynamic resolution of IP is in fact defined on ARCNet, the example we just used. We could do direct mapping there, but it restricts us to a certain pattern of IP addressing that reduces flexibility.

Dynamic Address Resolution

[Direct mapping](#) provides a simple and highly efficient means of resolving network layer addresses into data link layer addresses. Unfortunately, it is a technique that we either cannot or should not use in a majority of cases. We cannot use it when the size of the data link layer address is larger than that of the network layer address. We shouldn't use it when we need flexibility, because direct mapping requires us to make layer three and layer two addresses correspond.

The alternative to direct mapping is a technique called *dynamic address resolution*. To understand how this works, we can consider a simple analogy. I'm sure you've seen limousine drivers waiting to pick up a person at the airport they do not know personally. (Well, you've seen it in a movie, haven't you?) This is similar to our problem: they know the name of the person they must transport, but not the person's face (a type of "local address" in a manner of speaking!) To find the person, they hold up a card bearing that person's name. Everyone other than that person ignores the card, but hopefully the individual being sought will recognize it and approach the driver.

We do the same thing with dynamic address resolution in a network. Let's say that device *A* wants to send to device *B* but knows only device *B*'s network layer address (its "name") and not its data link layer address (its "face"). It broadcasts a layer two frame containing the layer three address of device *B*—this is like holding up the card with someone's name on it. The devices other than *B* don't recognize this layer three address and ignore it. *Device B*, however, knows its own network layer address. It recognizes this in the broadcast frame and sends a direct response back to device *A*. This tells device *A* what device *B*'s layer two address is, and the resolution is complete. [Figure 47](#) illustrates the process.



Key Concept: *Dynamic address resolution* is usually implemented using a special protocol. A device that knows only the network layer address of another device can use this protocol to request the other device's hardware address.

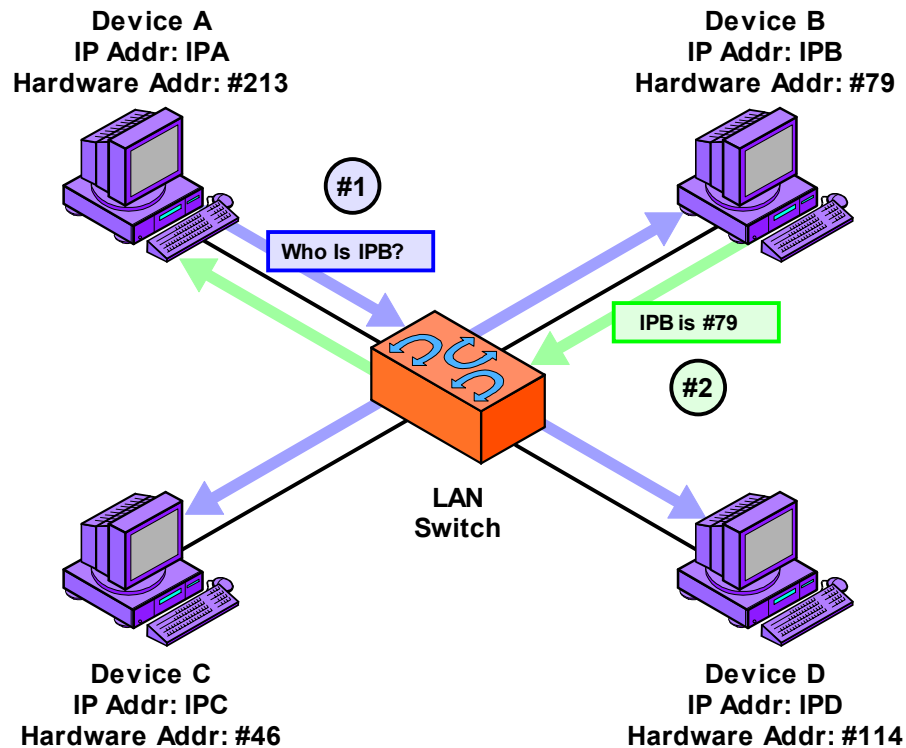

Figure 47: Dynamic Address Resolution

Device A needs to send data to Device B but knows only its IP address (“IPB”), and not its hardware address. A broadcasts a request asking to be sent the hardware address of the device using the IP address “IPB”. B responds back to A directly with the hardware address.

Direct mapping is very simple, but as you can see, dynamic resolution isn't exactly rocket science. It's a very simple technique that is easily implemented. Furthermore, it removes the restrictions associated with direct mapping. There is no need for any specific relationship between the network layer address and the data link layer address; they can have a completely different structure and size.

There is one nagging issue though: the efficiency problem. Where direct mapping involves a quick calculation, dynamic resolution requires us to use a protocol to send a message over the network. Fortunately, there are techniques that we can employ to remove some of the sting of this cost through careful implementation.

Dynamic Address Resolution Caching and Efficiency Issues

Dynamic address resolution removes the restrictions that we saw in our look at **direct mapping**, and allows us to easily associate layer two and layer three addresses of any size or structure. The only problem with it is that each address resolution requires us to send an extra message that would not be required in direct mapping. Worse yet, since we don't know the layer two identity of the recipient, we must use a **broadcast message** (or at least a multicast), which means that many devices on the local network must take resources to examine the data frame and check which IP address is being resolved.

Sure, sending one extra message may not seem like that big a deal, and the frame doesn't have to be very large since it contains only a network layer address and some control information. However, when we have to do this for **every** hop of **every** datagram transmission, the overhead really adds up. For this reason, while basic dynamic address resolution as described in the previous topic is simple and functional, it's usually not enough. We must add some **intelligence** to the implementation of address resolution to reduce the impact on performance of continual address resolutions.

The Benefits of Caching

Consider that most devices on a local network send to only a small handful of other physical devices, and tend to do so over and over again. This is a phenomenon known as *locality of reference*, and is observed in a variety of different areas in the field of computing. If you send a request to an Internet Web site from your office PC, it will need to go first to your company network's local router, so you will need to resolve the router's layer two address. If you later click a link on that site, that request will also need to go to the router. In fact, almost everything you do off your local network probably goes first to that same router (commonly called a *default gateway*). Having to do a fresh resolution each time is, well, stupid. It would be like having to look up the phone number of your best friend every time you want to call to say hello. (Reminds me of that sketch on Saturday Night Live where the guy had no short-term memory—but I digress.)

To avoid being accused of making address resolution protocols that are, well, stupid, designers always include a *caching* mechanism. After a device's network layer address is resolved to a data link layer address, the link between the two is kept in the memory of the device for a period of time. When it needs the layer two address the next time, the device just does a quick lookup in its cache. This means instead of doing a broadcast on every datagram, we only do it once for a whole sequence of datagrams.

Caching is by far the most important performance-enhancing tool in dynamic resolution. It transforms what would otherwise be a very wasteful process into one which most of the time is no less efficient than direct mapping. It does, however, add complexity. The cache table entries must be maintained. There is also the problem that the information in the table may become *stale* over time; what happens if we change the network layer address or the data link layer address of a device? For this reason, cache entries must be set to expire periodically. [The topic on caching in the TCP/IP ARP protocol](#) shows some of the particulars of how these issues are handled.

Other Enhancements to Dynamic Resolution

Other enhancements are also possible to the basic dynamic resolution scheme. Let's consider again our example of sending a request to the Internet. We send a request that needs to go to our local router, so we resolve its address and send it the request. A moment later the reply comes back to the router to be sent to us, so the router needs *our* address. Thus, it would have to do a dynamic resolution on us even though we just exchanged frames. Again: stupid. Instead, we can improve efficiency through *cross-resolution*; when device *A* resolves the address of device *B*, device *B* also adds the entry for device *A* to *its* cache.

Another improvement can be made too. If you think about it, the devices on a local network are going to talk to each other fairly often, even if they aren't chatting right now. If *A* is resolving *B*'s network layer address, it will broadcast a frame that devices *C*, *D*, *E* and so on all see. Why not have them also update *their* cache tables with resolution information that they see, for future use?

These and other enhancements all serve to cut down on the efficiency problems with dynamic address resolution. They combine to make dynamic resolution close enough to direct mapping in overall capability that there is no good reason not to use it. Once again, you can see some more particulars of this in [the topic that describes the TCP/IP ARP protocol's caching feature](#).

Incidentally, one other performance-improving idea sometimes is brought up in this discussion: instead of preceding a datagram transmission with an extra broadcast step for address resolution, why not just broadcast the datagram and be done with it? We actually could do this, and if the datagram were small enough it would be more efficient. Usually, though, datagrams are large, while resolution frames can be quite compact; it makes sense to do a small broadcast and then a large unicast rather than a large broadcast. Also, suppose we did broadcast this one datagram: what about the next datagram and the one after that? Each of these would then need to be broadcast also. When we do a resolution, with caching, we need to broadcast only once in a while instead of continually.



TCP/IP Address Resolution Protocol (ARP)

The most widely used network layer protocol in the world—by far—is the [TCP/IP Internet Protocol](#). It's no surprise then, that the most important address resolution protocol is the TCP/IP protocol bearing the same name as the technique itself: the *Address Resolution Protocol (ARP)*. ARP is a full-featured [dynamic resolution protocol](#) used to match IP addresses to underlying data link layer addresses. Originally developed for Ethernet, it has now been generalized to allow IP to operate over a wide variety of layer two technologies.

In this section I describe the operation and features of ARP. I begin with an overview of the protocol, and a discussion of its defining standards and history. I briefly outline how addresses are specified in ARP and its general operation, as well as describing the message format used for ARP messages. I then turn to the important matter of caching in ARP and how that is used to improve performance. I conclude with a discussion of proxying in ARP, which is needed to support special network connectivity situations.



Background Information: The general explanation of address resolution, what it is, and how it works, can be found in [the preceding section on address resolution concepts](#). Except for a brief recap at the start of the [overview](#), I assume you have familiarity with these concepts.



Note: The Address Resolution Protocol described here is used for resolving unicast addresses in [version 4 of the Internet Protocol](#). [Multicast addresses](#) under IPv4 use a direct mapping method, [described in a separate topic](#). IPv6 uses the new [Neighbor Discovery protocol](#) instead of ARP; this is discussed in [the overview of IPv6 address resolution](#).



Related Information: For a discussion of ARP-related issues in networks with mobile IP devices, see [the section on Mobile IP](#).



Related Information: The software application “arp”, which is used to administer the TCP/IP ARP implementation on a host, is covered in [its own topic](#) in [the section on TCP/IP utilities](#).

ARP Overview, Standards and History

Physical networks function at layers one and two of the OSI Reference Model, and use data link layer addresses. In contrast, internetworking protocols function at layer three, interconnecting these physical networks to create a possibly huge internetwork of devices specified using network layer addresses. Address resolution is the process where network layer addresses are resolved into data link layer addresses, to permit data to be sent one hop at a time across an internetwork. [I describe address resolution in detail in the preceding section on concepts.](#)

The problem of address resolution was apparent from the very start in the development of the TCP/IP protocol suite. Much of the early development of IP was performed on the then-fledgling [Ethernet local area networking technology](#); this was even before Ethernet had been officially standardized as IEEE 802.3. It was necessary to define a way to map IP addresses to Ethernet addresses to allow communication over Ethernet networks.

There are two basic methods that resolution could have been used to accomplish this correlation of addresses: [direct mapping](#) or [dynamic resolution](#). However, Ethernet addresses are 48 bits long while IP addresses are only 32 bits, which immediately rules out direct mapping. Furthermore, the designers of IP wanted the flexibility that results from using the dynamic resolution model. To this end, they developed the TCP/IP *Address Resolution Protocol (ARP)*. This protocol is described in one of the earliest of the Internet RFCs still in common use: RFC 826, [*An Ethernet Address Resolution Protocol*](#), published in 1982.

The name makes clear that ARP was originally developed for Ethernet. Thus, it represents a nexus between the most popular layer two LAN protocol and the most popular layer three internetworking protocol—this is true even two decades later. However, it was also obvious from the beginning that even if Ethernet was a very common way of transporting IP, it would not be the only one. Therefore, ARP was made a general protocol capable of resolving addresses from IP to not just Ethernet but numerous other data link layer technologies.

The basic operation of ARP involves encoding the IP address of the intended recipient in a broadcast message. It is sent on a local network to allow the intended recipient of an IP datagram to respond to the source with its data link layer address. This is done using a simple request/reply method described in [the following topic on general operation](#). A [special format is used for ARP messages](#), which are passed down to the local data link layer for transmission.



Key Concept: *ARP* was developed to facilitate dynamic address resolution between IP and Ethernet, and can now be used on other layer two technologies as well. It works by allowing an IP device to send a broadcast on the local network, requesting that another device on the same local network respond with its hardware address.

This basic operation is supplemented by methods to improve performance. Since it was known from the start that having to perform a resolution using broadcast for each datagram was ridiculously inefficient, ARP has always used a [cache](#), where it keeps bindings between IP addresses and data link layer addresses on the local network. Over time, various techniques have been developed to improve the methods used for maintaining cache entries. Refinements and additional features, such as support for cross-resolution by pairs of devices as well as [proxy ARP](#), have also been defined over the years and added to the basic ARP feature set.

ARP Address Specification and General Operation

An Address Resolution Protocol transaction begins when a source device on an IP network has an IP datagram to send. It must first decide whether the destination device is on the local network or a distant network. If the former, it will send directly to the destination; if the latter, it will send the datagram to one of the routers on the physical network for forwarding. Either way, it will determine the IP address of the device that needs to be the immediate destination of its IP datagram on the local network. After packaging the datagram it will pass it to its ARP software for address resolution.

Basic operation of ARP is a *request/response* pair of transmissions on the local network. The source (the one that needs to send the IP datagram) transmits a [broadcast](#) containing information about the destination (the intended recipient of the datagram). The destination then responds unicast back to the source, telling the source the hardware address of the destination.

ARP Message Types and Address Designations

The terms source and destination apply to the same devices throughout the transaction. However, there are two different messages sent in ARP, one from the source to the destination and one from the destination to the source. For each ARP message, the *sender* is the one that is transmitting the message and the *target* is the one receiving it. Thus, the identity of the sender and target change for each message:

- ☉ **Request:** For the initial request, the sender is the source, the device with the IP datagram to send, and the target is the destination.
- ☉ **Reply:** For the reply to the ARP request, the sender is the destination; it replies to the source, which becomes the target.

It's a bit confusing, but you'll get used to it. ☹ Each of the two parties in any message has two addresses (layer two and layer three) to be concerned with, so four different addresses are involved in each message:

- ☉ **Sender Hardware Address:** The layer two address of the sender of the ARP message.
- ☉ **Sender Protocol Address:** The layer three (IP) address of the sender of the ARP message.
- ☉ **Target Hardware Address:** The layer two address of the target of the ARP message.

- ☺ **Target Protocol Address:** The layer three (IP) address of the target.

These addresses each have a position in the [ARP message format](#).

ARP General Operation

With that background in place, let's look at the steps followed in an ARP transaction (which are also shown graphically in the illustration in [Figure 48](#)):

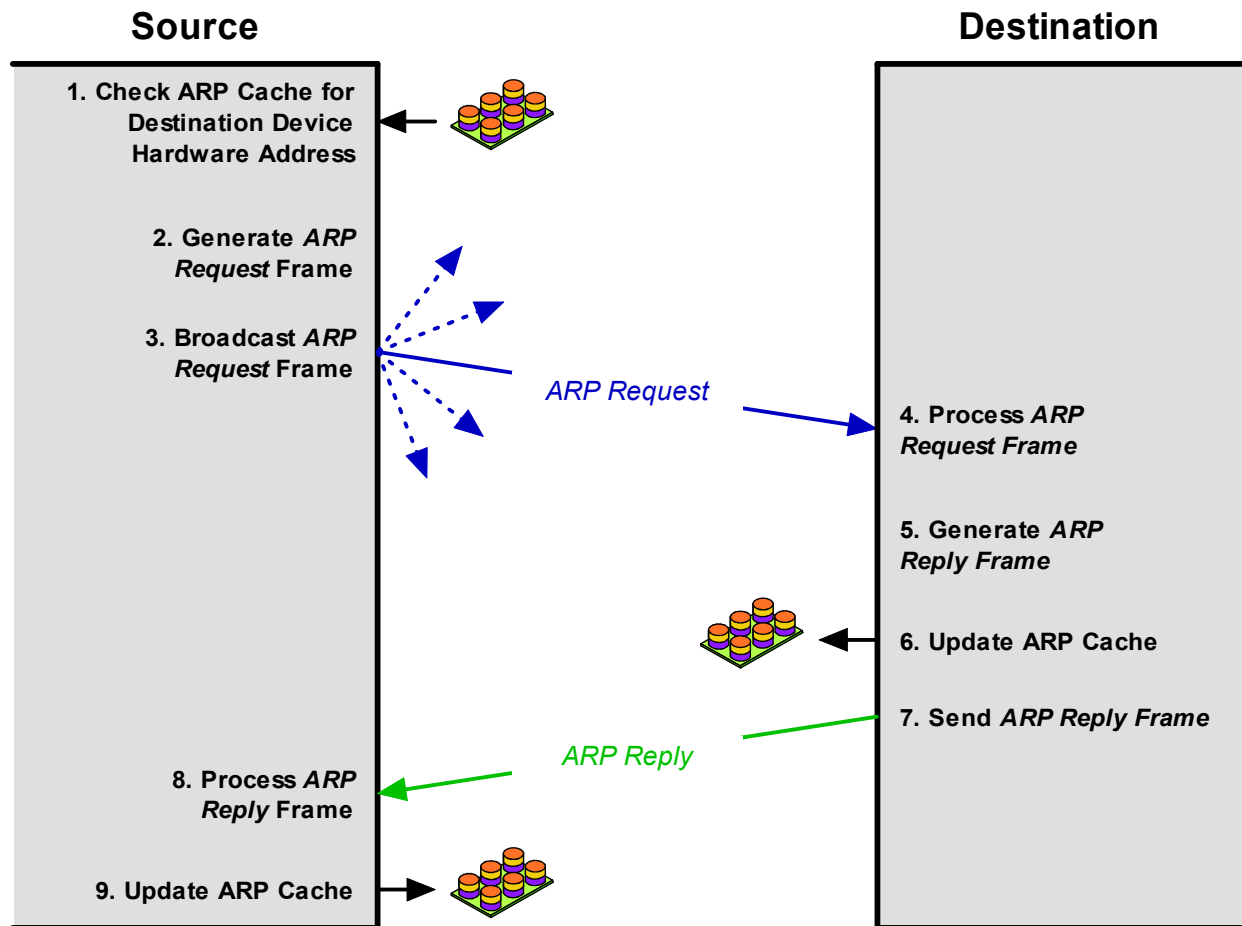

Figure 48: Address Resolution Protocol (ARP) Transaction Process

This diagram shows the sequence of steps followed in a typical ARP transaction, as well as the message exchanges between a source and destination device, and cache checking and update functions. (Those little columns are supposed to be hard disks, not cans of soup! ☺)

1. **Source Device Checks Cache:** The source device will first check its [cache](#) to determine if it already has a resolution of the destination device. If so, it can skip to the last step of this process, step #9.

-
2. **Source Device Generates ARP Request Message:** The source device generates an *ARP Request* message. It puts its own data link layer address as the *Sender Hardware Address* and its own IP address as the *Sender Protocol Address*. It fills in the IP address of the destination as the *Target Protocol Address*. (It must leave the *Target Hardware Address* blank, since that is what it is trying to determine!)
 3. **Source Device Broadcasts ARP Request Message:** The source broadcasts the *ARP Request* message on the local network.
 4. **Local Devices Process ARP Request Message:** The message is received by each device on the local network. It is processed, with each device looking for a match on the *Target Protocol Address*. Those that do not match will drop the message and take no further action.
 5. **Destination Device Generates ARP Reply Message:** The one device whose IP address matches the contents of the *Target Protocol Address* of the message will generate an *ARP Reply* message. It takes the *Sender Hardware Address* and *Sender Protocol Address* fields from the *ARP Request* message and uses these as the values for the *Target Hardware Address* and *Target Protocol Address* of the reply. It then fills in its own layer two address as the *Sender Hardware Address* and its IP address as the *Sender Protocol Address*. Other fields are filled in as explained in [the topic describing the ARP message format](#).
 6. **Destination Device Updates ARP Cache:** If the source needs to send an IP datagram to the destination now, it makes sense that the destination will probably need to send a response to the source at some point soon. (After all, most communication on a network is bidirectional.) As an optimization, then, the destination device will add an entry to its own ARP cache containing the hardware and IP addresses of the source that sent the *ARP Request*. This saves the destination from needing to do an unnecessary resolution cycle later on.
 7. **Destination Device Sends ARP Reply Message:** The destination device sends the *ARP reply* message. This reply is, however, sent unicast to the source device, as there is no need to broadcast it.
 8. **Source Device Processes ARP Reply Message:** The source device processes the reply from the destination. It stores the *Sender Hardware Address* as the layer two address of the destination, to use for sending its IP datagram.
 9. **Source Device Updates ARP Cache:** The source device uses the *Sender Protocol Address* and *Sender Hardware Address* to update its ARP cache for use in the future when transmitting to this device.



Key Concept: ARP is a relatively simple request/reply protocol. The source device broadcasts an *ARP Request* looking for a particular device based on its IP address. That device responds with its hardware address in an *ARP Reply* message.

Note that this description goes a bit beyond the basic steps in address resolution, because two enhancements are mentioned. One is caching, which is described in [its own topic](#) but had to be mentioned here because it is the first step in the process, for obvious reasons. The other is cross-resolution (described in [the overview of caching issues in dynamic](#)

resolution), which is step #6 of the process. This is why the source device includes its IP address in the request. It isn't really needed for any other reason, so you can see that this feature was built into ARP from the start.

ARP Message Format

Address resolution using [ARP](#) is accomplished through the [exchange of messages](#) between the source device seeking to perform the resolution, and the destination device that responds to it. As with other protocols, a special *message format* is used containing the information required for each step of the resolution process.

ARP messages use a relatively simple format. It includes a field describing the type of message (its *operational code* or *opcode*) and information on both layer two and layer three addresses. In order to support addresses that may be of varying length, the format specifies the type of protocol used at both layer two and layer three and the length of addresses used at each of these layers. It then includes space for all four of the address combinations we saw in [the previous topic](#).

The format used for ARP messages is described fully in [Table 43](#), and illustrated in [Figure 49](#).

Table 43: Address Resolution Protocol (ARP) Message Format (Page 1 of 2)

Field Name	Size (bytes)	Description																				
HRD	2	<p>Hardware Type: This field specifies the type of hardware used for the local network transmitting the ARP message; thus, it also identifies the type of addressing used. Some of the most common values for this field:</p> <table border="1"> <thead> <tr> <th>HRD Value</th> <th>Hardware Type</th> </tr> </thead> <tbody> <tr> <td>1</td> <td>Ethernet (10 Mb)</td> </tr> <tr> <td>6</td> <td>IEEE 802 Networks</td> </tr> <tr> <td>7</td> <td>ARCNET</td> </tr> <tr> <td>15</td> <td>Frame Relay</td> </tr> <tr> <td>16</td> <td>Asynchronous Transfer Mode (ATM)</td> </tr> <tr> <td>17</td> <td>HDLC</td> </tr> <tr> <td>18</td> <td>Fibre Channel</td> </tr> <tr> <td>19</td> <td>Asynchronous Transfer Mode (ATM)</td> </tr> <tr> <td>20</td> <td>Serial Line</td> </tr> </tbody> </table>	HRD Value	Hardware Type	1	Ethernet (10 Mb)	6	IEEE 802 Networks	7	ARCNET	15	Frame Relay	16	Asynchronous Transfer Mode (ATM)	17	HDLC	18	Fibre Channel	19	Asynchronous Transfer Mode (ATM)	20	Serial Line
HRD Value	Hardware Type																					
1	Ethernet (10 Mb)																					
6	IEEE 802 Networks																					
7	ARCNET																					
15	Frame Relay																					
16	Asynchronous Transfer Mode (ATM)																					
17	HDLC																					
18	Fibre Channel																					
19	Asynchronous Transfer Mode (ATM)																					
20	Serial Line																					
PRO	2	<p>Protocol Type: This field is the complement of the <i>Hardware Type</i> field, specifying the type of layer three addresses used in the message. For IPv4 addresses, this value is 2048 (0800 hex), which corresponds to the EtherType code for the Internet Protocol.</p>																				

Table 43: Address Resolution Protocol (ARP) Message Format (Page 2 of 2)

Field Name	Size (bytes)	Description																				
HLN	1	Hardware Address Length: Specifies how long hardware addresses are in this message. For Ethernet or other networks using IEEE 802 MAC addresses, the value is 6.																				
PLN	1	Protocol Address Length: Again, the complement of the preceding field; specifies how long protocol (layer three) addresses are in this message. For IP(v4) addresses this value is of course 4.																				
OP	2	<p>Opcode: This field specifies the nature of the ARP message being sent. The first two values (1 and 2) are used for regular ARP. Numerous other values are also defined to support other protocols that use the ARP frame format, such as RARP, some of which are more widely used than others:</p> <table border="1" data-bbox="734 688 1312 1157"> <thead> <tr> <th>Opcode</th> <th>ARP Message Type</th> </tr> </thead> <tbody> <tr> <td>1</td> <td>ARP Request</td> </tr> <tr> <td>2</td> <td>ARP Reply</td> </tr> <tr> <td>3</td> <td>RARP Request</td> </tr> <tr> <td>4</td> <td>RARP Reply</td> </tr> <tr> <td>5</td> <td>DRARP Request</td> </tr> <tr> <td>6</td> <td>DRARP Reply</td> </tr> <tr> <td>7</td> <td>DRARP Error</td> </tr> <tr> <td>8</td> <td>InARP Request</td> </tr> <tr> <td>9</td> <td>InARP Reply</td> </tr> </tbody> </table>	Opcode	ARP Message Type	1	ARP Request	2	ARP Reply	3	RARP Request	4	RARP Reply	5	DRARP Request	6	DRARP Reply	7	DRARP Error	8	InARP Request	9	InARP Reply
Opcode	ARP Message Type																					
1	ARP Request																					
2	ARP Reply																					
3	RARP Request																					
4	RARP Reply																					
5	DRARP Request																					
6	DRARP Reply																					
7	DRARP Error																					
8	InARP Request																					
9	InARP Reply																					
SHA	(Variable, equals value in <i>HLN</i> field)	Sender Hardware Address: The hardware (layer two) address of the device sending this message (which is the IP datagram source device on a request, and the IP datagram destination on a reply, as discussed in the topic on ARP operation).																				
SPA	(Variable, equals value in <i>PLN</i> field)	Sender Protocol Address: The IP address of the device sending this message.																				
THA	(Variable, equals value in <i>HLN</i> field)	Target Hardware Address: The hardware (layer two) address of the device this message is being sent to. This is the IP datagram destination device on a request, and the IP datagram source on a reply)																				
TPA	(Variable, equals value in <i>PLN</i> field)	Target Protocol Address: The IP address of the device this message is being sent to.																				

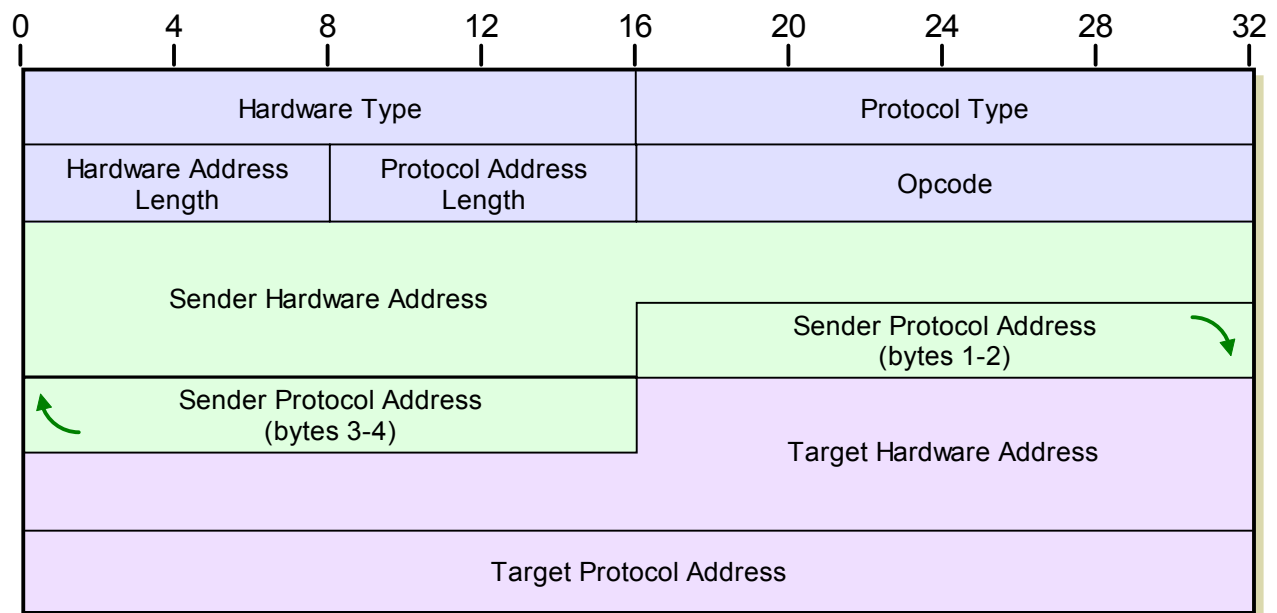

Figure 49: Address Resolution Protocol (ARP) Message Format

The ARP message format is designed to accommodate layer two and layer three addresses of various sizes. This diagram shows the most common implementation, which uses 32 bits for the layer three (“Protocol”) addresses, and 48 bits for the layer two hardware addresses. These numbers of course correspond to the address sizes of the [Internet Protocol version 4](#) and [IEEE 802 MAC addresses](#), used by Ethernet.

After the ARP message has been composed it is passed down to the data link layer for transmission. The entire contents of the message becomes the payload for the message actually sent on the network, such as an Ethernet frame. Note that the total size of the ARP message is variable, since the address fields are of variable length. Normally, though, these messages are quite small: for example, they are only 28 bytes for a network carrying IPv4 datagrams in IEEE 802 MAC addresses.

ARP Caching

ARP is a [dynamic resolution protocol](#), which means that every resolution requires the interchange of messages on the network. Each time a device sends an ARP message, it ties up the local network, consuming network bandwidth that cannot be used for “real” data traffic. ARP messages aren’t large, but having to send them for every hop of every IP datagram would represent an unacceptable performance hit on the network. It also wastes time compared to the simpler direct mapping method of resolution. On top of this, the *ARP Request* message is broadcasted, which means every device on the local network must spend CPU time examining the contents of each one.

The general solution to the efficiency issues with dynamic resolution is to employ *caching*, which I described in general terms in the section on [address resolution concepts](#). In addition to reducing network traffic, caching also ensures that the resolution of commonly-used addresses is fast, making overall performance comparable to direct mapping. For this reason, caching functionality has been [built into ARP](#) from the start.

Static and Dynamic ARP Cache Entries

The ARP cache takes the form of a table containing matched sets of hardware and IP addresses. Each device on the network manages its own ARP cache table. There are two different ways that cache entries can be put into the ARP cache:

- ① **Static ARP Cache Entries:** These are address resolutions that are manually added to the cache table for a device and are kept in the cache on a permanent basis. Static entries are typically managed using a tool such as the [arp software utility](#).
- ② **Dynamic ARP Cache Entries:** These are hardware/IP address pairs that are added to the cache by the software itself as a result of successfully-completed past ARP resolutions. They are kept in the cache only for a period of time and are then removed.

A device's ARP cache can contain both static and dynamic entries, each of which has advantages and disadvantages. However, dynamic entries are used most often because they are automatic and don't require administrator intervention.

Static ARP entries are best used for devices that a given device has to communicate with on a regular basis. For example, a workstation might have a static ARP entry for its local router and file server. Since the entry is static it is always found in [step #1 of the ARP transaction process](#), there is no need to ever send resolution messages for the destination in that entry. The disadvantage is that these entries must be manually added, and they must also be changed if the hardware or IP addresses of any of the hardware in the entries change. Also, each static entry takes space in the ARP cache, so you don't want to "overuse" static entries. It wouldn't be a good idea to have static entries for every device on the network, for example.

Cache Entry Expiration

Dynamic entries are added automatically to the cache on an "as needed" basis, so they represent mappings for hosts and routers that a given device is actively using. They do not need to be manually added or maintained. However, it is also important to realize that dynamic entries cannot be added to the cache and left there forever. The reason for this is that due to changes in the network, dynamic entries left in place for a long time can become *stale*.

Consider device A's ARP cache, which contains a dynamic mapping for device B, another host on the network. If dynamic entries stayed in the cache forever, the following situations might arise:

- ① **Device Hardware Changes:** Device B might experience a hardware failure that requires its network interface card to be replaced. The mapping in device A's cache would become invalid, since the hardware address in the entry is no longer on the network.
- ② **Device IP Address Changes:** Similarly, the mapping in device A's cache also would become invalid if device B's IP address changed.
- ③ **Device Removal:** Suppose device B is removed from the local network. Device A would never need to send to it again at the data link layer, but the mapping would remain in device A's cache, wasting space and possibly taking up search time.

To avoid these problems, dynamic cache entries must be set to automatically expire after a period of time. This is handled automatically by the ARP implementation, with typical timeout values being 10 or 20 minutes. After a particular entry times out, it is removed from the cache. The next time that address mapping is needed a fresh resolution is performed to update the cache. This is very slightly less efficient than static entries, but sending two 28-byte messages every 10 or 20 minutes isn't a big deal.

As mentioned in [the overview of ARP operation](#), dynamic cache entries are added not only when a device initiates a resolution, but when it is the destination device as well. This is another enhancement that reduces unnecessary address resolution traffic.

Additional Caching Features

Other enhancements are also typically put into place, depending on the implementation. Standard ARP requires that if device *A* initiates resolution with a broadcast, each device on the network should update its own cache entries for device *A* even if they are not the device that *A* is trying to reach. However, these “third party” devices are ***not*** required to create new cache entries for *A* in this situation.

The issue here is a trade-off: creating a new cache entry would save any of those devices from needing to resolve device *A*'s address in the near future. However, it also means every device on the network will quickly have an ARP cache table filled up with the addresses of most of the other devices on the network. This may not be desirable in larger networks. Even in smaller ones, this model may not make sense, given that modern computing is [client/server in nature](#) and peer devices on a LAN may not often communicate directly. Some devices may choose to create such cache entries, but set them to expire after a very short time to avoid filling the cache.

Each ARP implementation is also responsible for any other “housekeeping” required to maintain the cache. For example, if a device is on a local network with many hosts and its cache table is too small, it might be necessary for older, less-frequently-used entries to be removed to make room for newer ones. Ideally, the cache should be large enough to hold all other devices on the network that a device communicates with on a regular basis, along with some room for ones it occasionally talks to.

Proxy ARP

ARP was designed to be used by devices that are directly connected on a local network. Each device on the network should be capable of sending both unicast and broadcast transmissions directly to each other one. Normally, if device *A* and device *B* are separated by a router, they would not be considered local to each other. Device *A* would not send directly to *B* or vice-versa; they would send to the router instead at layer two, and would be considered “two hops apart” at layer three.

Why Proxy ARP Is Needed

In contrast to the normal situation, in some networks there might be two physical network segments connected by a router that are in the same IP network or subnet. In other words, device *A* and device *B* might be on different networks at the data link layer level, but on the same IP network or subnet. When this happens, *A* and *B* will each think the other is on the local network when they look to send IP datagrams.

In this situation, suppose that *A* wants to send a datagram to *B*. It doesn't have *B*'s hardware address in the cache, so it begins an address resolution. When it broadcasts the *ARP Request* message to get *B*'s hardware address, however, it will quickly run into a problem: *B* is in fact not on *A*'s local network. The router between them will not pass *A*'s broadcast onto *B*'s part of the network, because routers don't pass hardware-layer broadcasts. *B* will never get the request and thus *A* will not get a reply containing *B*'s hardware address.

Proxy ARP Operation

The solution to this situation is called *ARP proxying* or *Proxy ARP*. In this technique, the router that sits between the local networks is configured to respond to device *A*'s broadcast on behalf of device *B*. It does not send back to *A* the hardware address of device *B*; since they are not on the same network, *A* cannot send directly to *B* anyway. Instead, the router sends *A* its own hardware address. *A* then sends to the router, which forwards the message to *B* on the other network. Of course, the router also does the same thing on *A*'s behalf for *B*, and for every other device on both networks, when a broadcast is sent that targets a device not on the same actual physical network as the resolution initiator. This is illustrated in [Figure 50](#).

Proxy ARP provides flexibility for networks where hosts are not all actually on the same physical network but are configured as if they were at the network layer. It can be used to provide support in other special situations where a device cannot respond directly to ARP message broadcasts. It may be used when a firewall is configured for security purposes. A type of proxying is also used [as part of the Mobile IP protocol](#), to solve the problem of address resolution when a mobile device travels away from its home network.



Key Concept: Since ARP relies on broadcasts for address resolution, and broadcasts are not propagated beyond a physical network, ARP cannot function between devices on different physical networks. When such operation is required, a device, such as a router, can be configured as an ARP proxy to respond to ARP requests on the behalf of a device on a different network.

Advantages and Disadvantages of Proxying

The main advantage of proxying is that it is transparent to the hosts on the different physical network segments. The technique has some drawbacks though. First, it introduces added complexity. Second, if more than one router connects two physical networks using the

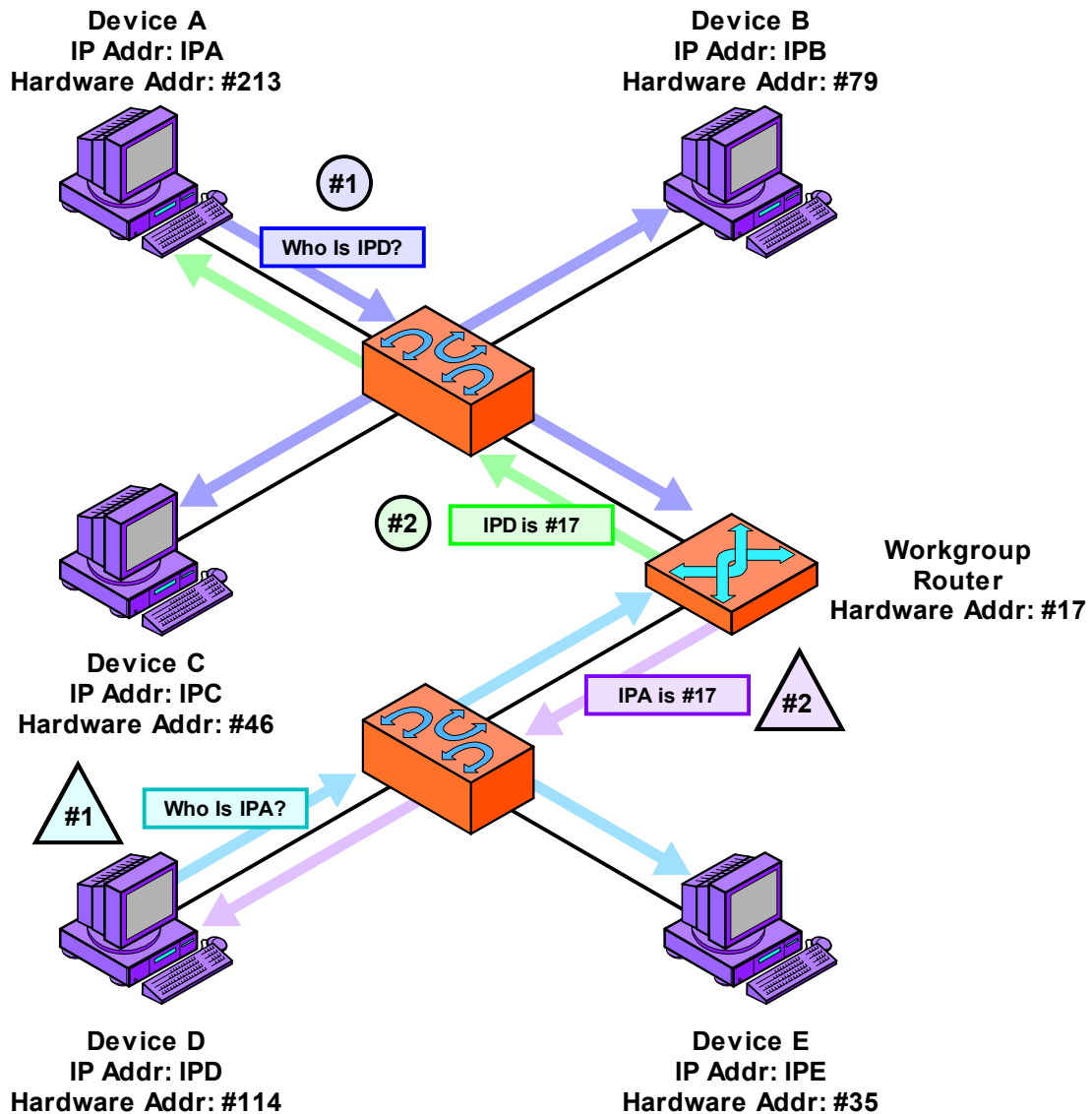

Figure 50: ARP Proxy Operation

In this small internetwork, a single router connects two LANs that are on the same IP network or subnet. The router will not pass ARP broadcasts, but has been configured to act as an ARP proxy. In this example, device A and device D are each trying to send an IP datagram to the other, and so each broadcasts an *ARP Request*.

The router responds to the request sent by Device A as if it were Device D, giving to A its own hardware address (without propagating Device A's broadcast.) It will forward the message sent by A to D on D's network. Similarly, it responds to Device D as if it were Device A, giving its own address, then forwarding what D sends to it over to the network where A is located.

same network ID, problems may arise. Third, it introduces potential security risks; since it essentially means that a router "impersonates" devices in acting as a proxy for them, raising the potential for a device to spoof another. For these reasons, it may be better to redesign the network so routing is done between physical networks separated by a router, if possible.

TCP/IP Address Resolution For IP Multicast Addresses

Like most discussions of address resolution, the preceding sections all focus on [unicast communication](#), where a datagram is sent from one source device to one destination device. Whether direct mapping or dynamic resolution is used for resolving a network layer address, it is a relatively simple matter to resolve addresses when there is only one intended recipient of the datagram. TCP/IP uses [ARP](#) for its dynamic resolution scheme, which is designed for unicast resolution only.

However, the Internet Protocol also supports *multicasting* of datagrams, as I explain in the topics on [IP multicasting](#) and [IP multicast addressing](#). In this situation, the datagram must be sent to multiple recipients, which complicates matters considerably. We need to establish a relationship of some sort between the IP multicast group address and the addresses of the devices at the data link layer. We could do this by converting the IP multicast datagram to individual unicast transmissions at the data link layer, each using ARP for resolution, but this would be horribly inefficient.

Direct Mapping Technique for IEEE 802 Multicast MAC Addresses

When possible, IP makes use of the multicast addressing and delivery capabilities of the underlying network to deliver multicast datagrams on a physical network. Perhaps surprisingly, even though ARP employs dynamic resolution, multicast address resolution is done using a version of the [direct mapping technique](#). By defining a *mapping* between IP multicast groups and data link layer multicast groups we enable physical devices to know when to pay attention to multicasted datagrams.

The most commonly used multicast-capable data link addressing scheme is the [IEEE 802 addressing system](#) best known for its use in Ethernet networks. These data link layer addresses have 48 bits, arranged into two blocks of 24. The upper 24 bits are arranged into a block called the *organizationally unique identifier (OUI)*, with different values assigned to individual organizations; the lower 24 bits are then used for specific devices.

The [Internet Assigned Number Authority \(IANA\)](#) itself has an OUI that it uses for mapping multicast addresses to IEEE 802 addresses. This OUI is "01:00:5E". To form a mapping for Ethernet, 24 bits are used for this OUI and the 25th (of the 48) is always zero. This leaves 23 bits of the original 48 to encode the multicast address. To do the mapping, the lower-order 23 bits of the multicast address are used as the last 23 bits of the Ethernet address starting with "01:00:5E" for sending the multicast message. This process is illustrated in [Figure 51](#).



Key Concept: IP multicast addresses are resolved to IEEE 802 (Ethernet) MAC addresses using a direct mapping technique that uses 23 of the 28 bits in the IP multicast group address.

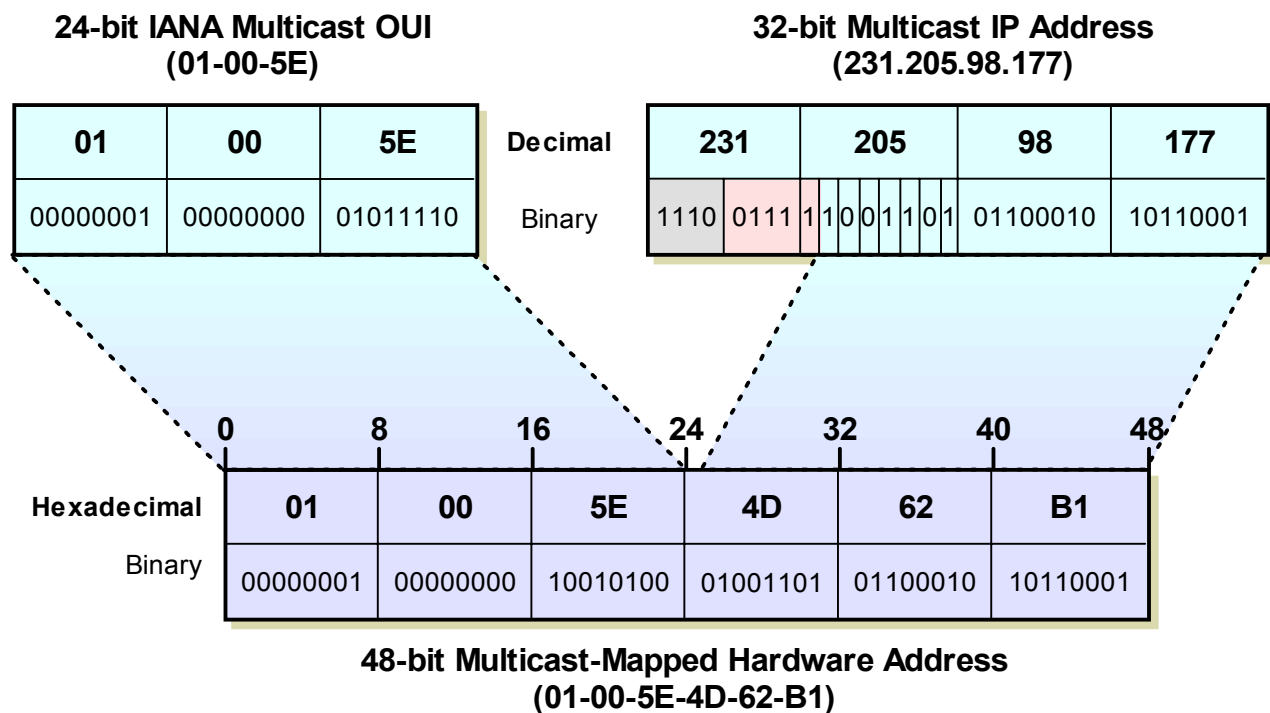

Figure 51: Mapping of Multicast IP Addresses to IEEE 802 Multicast MAC Addresses
 IP multicast addresses consist of the bit string “1110” followed by a 28-bit multicast group address. To create a 48-bit multicast IEEE 802 (Ethernet) address, the top 24 bits are filled in with the IANA’s multicast OUI, 01-00-5E, the 25th bit is zero, and the bottom 23 bits of the multicast group are put into the bottom 23 bits of the MAC address. This leaves 5 bits (shown in pink) that are not mapped to the MAC address, meaning that 32 different IP addresses may have the same mapped multicast MAC address.

Dealing With Multiple IP Addresses Mapped To One Multicast Hardware Address

Of course, there are 28 unique bits in IP multicast addresses, so this is a “bit” of a problem. ☺ What it means is that there is no unique mapping between IP multicast addresses and Ethernet multicast addresses. Since 5 of the 28 bits of the multicast group cannot be encoded in the Ethernet address, 32 (2^5) different IP multicast addresses map onto each possible Ethernet multicast address. In theory, this would be a problem, but in practice, it isn’t. The chances of any two IP multicast addresses on a single network mapping to the same Ethernet multicast address at the same time are pretty small.

Still, it is possible that two IP multicast groups might be in use on the same physical network and might map to the same data link layer multicast address. For this reason, devices must not assume that all multicast messages they receive are for their groups; they must pass up the messages to the IP layer to check the full IP multicast address to make sure they really were supposed to get the multicast datagram they received. If they accidentally get one that was intended for a multicast group they are not a member of, they discard it. This happens infrequently so the relative lack of efficiency is not a large concern.



TCP/IP Address Resolution For IP Version 6

The [TCP/IP Address Resolution Protocol \(ARP\)](#) is a fairly generic protocol for dynamically resolving network layer addresses into data link layer addresses. Even though it was designed for IP version 4, the message format allows for variable-length addresses at both the hardware and network layers. This flexibility means it would have been theoretically possible to use it for the new version of IP—[version 6, or IPv6](#)—that is in our future. Some minor changes might have been required, but the technique could have been about the same.

The designers of IPv6 chose not to do this, however. Changing IP is a big job that has been underway for many years, and represents a rare opportunity to change various aspects of TCP/IP. The IETF decided to take advantage of the changes in IPv6 to overhaul not only IP itself, but also many of the protocols that “support” or “assist” IP. In IPv6, the address resolution job of ARP has been combined with several functions performed by ICMP in the original TCP/IP suite, supplemented with additional capabilities and defined as the new [Neighbor Discovery \(ND\) protocol](#).

The term “neighbor” in IPv6 simply refers to devices on a local network, and as the name implies, ND is responsible for tasks related to communicating information between neighbors (among other things). I describe ND briefly in [its own section](#), including a discussion of the various tasks it performs. Here I want to focus specifically on how ND performs address resolution.

Basic IPv6 Address Resolution Method

The basic concepts of address resolution in IPv6 ND aren't all that different from those in IPv4 ARP. Resolution is still dynamic and is based on the use of a cache table that maintains pairings of IPv6 addresses and hardware addresses. Each device on a physical network keeps track of this information for its neighbors. When a source device needs to send an IPv6 datagram to a local network neighbor but doesn't have its hardware address, it initiates the resolution process. For clarity in the text let's say that, as usual, device *A* is trying to send to device *B*.

Instead of sending an *ARP Request* message, *A* creates an ND *Neighbor Solicitation* message. Now, here's where the first big change can be seen from ARP. If the underlying data link protocol supports multicasting, like Ethernet does, the *Neighbor Solicitation* message is not broadcast. Instead, it is sent to the *solicited-node address* of the device whose IPv6 address we are trying to resolve. So *A* won't broadcast the message, it will multicast it to device *B*'s solicited-node multicast address.

Device *B* will receive the *Neighbor Solicitation* and respond back to device *A* with a *Neighbor Advertisement*. This is analogous to the *ARP Reply* and tells device *A* the physical address of *B*. Device *A* then adds device *B*'s information to its neighbor cache. For efficiency, cross-resolution is supported as in IPv4 address resolution. This is done by having Device *A* include its own layer two address in the *Neighbor Solicitation*, assuming it knows it. Device *B* will record this along with *A*'s IP address in *B*'s neighbor cache.

Using Solicited-Node Multicast Addresses For Resolution

The solicited-node multicast address is a special mapping that each device on a multicast-capable network creates from its unicast address; [it is described in the topic on IPv6 multicast addresses](#). The solicited-node address isn't unique for every IPv6 address, but the odds of any two neighbors on a given network having the same one are small. Each device that receives a multicasted *Neighbor Solicitation* must still check to make sure it is the device whose address the source is trying to resolve. (This is [similar to how multicast is handled in IPv4](#), with 32 different IP addresses potentially sharing a multicast MAC address.)

Why bother with this, if devices still have to check each message? Simple: the multicast will affect at most a small number of devices. With a broadcast, each and every device on the local network would receive the message, while the use of the solicited-node address means at most a couple of devices will need to process it. Other devices don't even have to bother checking the *Neighbor Solicitation* message at all.



Key Concept: Address resolution in IPv6 uses the new *Neighbor Discovery (ND) protocol* instead of the Address Resolution Protocol. A device trying to send an IPv6 datagram sends a *Neighbor Solicitation* message to get the address of another device, which responds with a *Neighbor Advertisement*. When possible, the request is sent using a special type of multicast address rather than broadcast, to improve efficiency.

This is actually a fairly simplified explanation of how resolution works in IPv6—the Neighbor Discovery protocol is quite complicated. Neighbor solicitations and advertisements are also used for other functions such as testing reachability of nodes and determining if duplicate addresses are in use. There are many special cases and issues that ND addresses to ensure that no problems result during address resolution. ND also supports proxied address resolution.



Note: Even though I put this topic where it would be near the other discussions of address resolution, the Neighbor Discovery protocol really isn't a “layer connection” or “lower level” protocol like ARP. It is analogous to [ICMP](#) in its role and function, and in fact makes use of [ICMP\(v6\) messages](#). One advantage of this architectural change is that there is less dependence on the characteristics of the physical network, so resolution is accomplished in a way more similar to other network support activities. Thus it is possible to make use of facilities that can be applied to all IP datagram transmissions, such as [IP security features](#). [The section on ND contains much more information on this subject.](#)



Reverse Address Resolution and the TCP/IP Reverse Address Resolution Protocol (RARP)

The [TCP/IP Address Resolution Protocol \(ARP\)](#) is used when a device needs to determine the layer two (hardware) address of some other device but has only its layer three (network, IP) address. It broadcasts a hardware layer request and the target device responds back with the hardware address matching the known IP address. In theory, it is also possible to use ARP in the exact opposite way. If we know the hardware address of a device but not its IP address, we could broadcast a request containing the hardware address and get back a response containing the IP address.

The Motivation For Reverse Address Resolution

Of course the obvious question is: why would we ever need to do this? Since we are dealing with communication on an IP internet, we are always going to know the IP address of the destination of the datagram we need to send—it's right there in the datagram itself. We also know our own IP address as well. Or do we?

In a traditional TCP/IP network, every normal host on a network knows its IP address because it is stored somewhere on the machine. When you turn on your PC, the TCP/IP protocol software reads the IP address from a file, which allows your PC to “learn” and start using its IP address. However, there are some devices, such as diskless workstations, that don't have any means of storing an IP address where it can be easily retrieved. When these units are powered up they know their physical address only (because it's wired into the hardware) but not their IP address.

The problem we need to solve here is what is commonly called *bootstrapping* in the computer industry. This refers to the concept of starting something from a zero state; it is analogous to “pulling yourself up by your own bootstraps”. This is seemingly impossible, just as it seems paradoxical to use a TCP/IP protocol to configure the IP address that is needed for TCP/IP communications. However, it is indeed possible to do this, by making use of [broadcasts](#), which allow local communication even when the target's address is not known.

The Reverse Address Resolution Protocol (RARP)

The first method devised to address the bootstrapping problem in TCP/IP was the backwards use of ARP I mentioned above. This technique was formalized in RFC 903, [A Reverse Address Resolution Protocol \(RARP\)](#), published in 1984. Where ARP allows device *A* to say “I am device *A* and I have device *B*'s IP address, device *B* please tell me your hardware address”, RARP is used by device *A* to say “I am device *A* and I am sending this broadcast using my hardware address, can someone please tell me *my* IP address?”. The two-step operation of RARP is illustrated in [Figure 52](#).

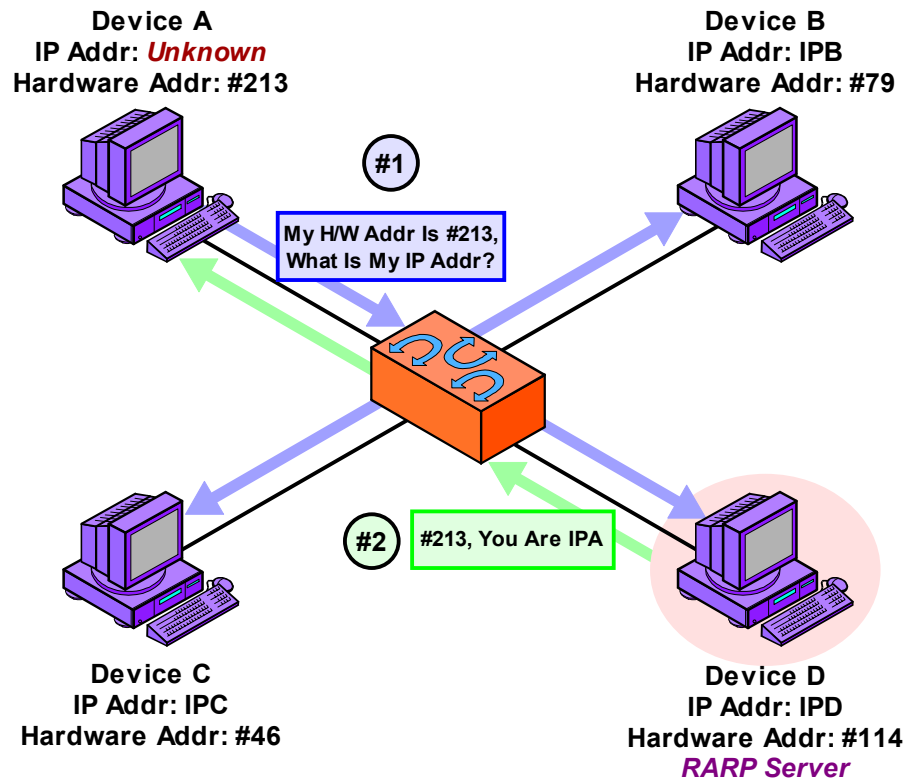

Figure 52: Operation of the Reverse Address Resolution Protocol (RARP)

RARP, as the name suggests, works like ARP but in reverse, so this diagram is similar to [Figure 47](#). Here, instead of Device A providing the IP address of another device and asking for its hardware address, it is providing its own hardware address and asking for an IP address it can use. The answer, in this case, is provided by Device D, which is serving as an RARP server for this network.

The next question then is: who knows A's IP address if device A doesn't? The answer is that a special *RARP server* must be configured to listen for RARP requests and issue replies to them. Each physical network where RARP is in use must have RARP software running on at least one machine.

RARP is not only very similar to ARP, it basically *is* ARP. What I mean by this is that RFC 903 doesn't define a whole new protocol from scratch, it just describes a new method for using ARP to perform the opposite of its normal function. RARP uses ARP messages in [exactly the same format as ARP](#), but uses different opcodes to accomplish its reverse function. Just as in ARP, a request and reply are used in an exchange. [The meaning of the address fields is the same](#) too: the sender is the device transmitting a message while the target is the one receiving it.



Key Concept: The *Reverse Address Resolution Protocol (RARP)* is the earliest and simplest protocol designed to allow a device to obtain an IP address for use on a TCP/IP network. It is based directly on ARP and works in basically the same way, but in reverse: a device sends a request containing its hardware address and a device set up as an RARP server responds back with the device's assigned IP address.

RARP General Operation

Here are the steps followed in a RARP transaction (illustrated in [Figure 53](#)):

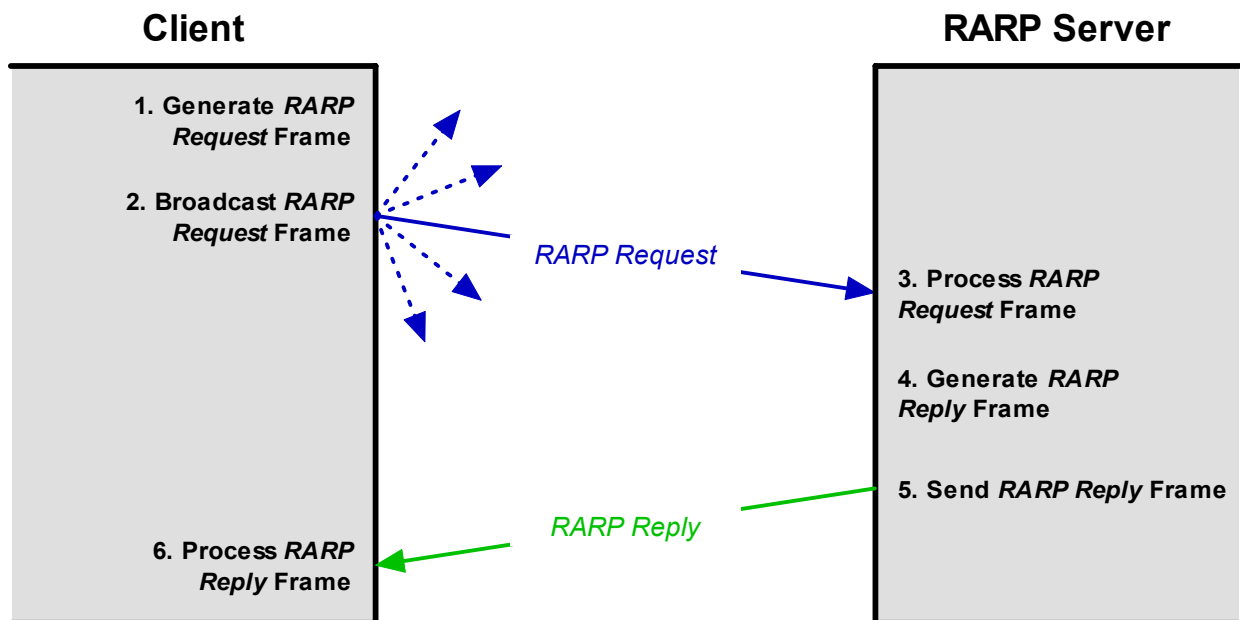

Figure 53: Reverse Address Resolution Protocol (RARP) Operation

RARP uses a simple request/reply exchange to allow a device to obtain an IP address.

1. **Source Device Generates RARP Request Message:** The source device generates an *RARP Request* message. Thus, it uses the value 3 for the *Opcode* in the message. It puts its own data link layer address as both the *Sender Hardware Address* and also the *Target Hardware Address*. It leaves both the *Sender Protocol Address* and the *Target Protocol Address* blank, since it doesn't know either.
2. **Source Device Broadcasts RARP Request Message:** The source broadcasts the *ARP Request* message on the local network.
3. **Local Devices Process RARP Request Message:** The message is received by each device on the local network and processed. Devices that are not configured to act as RARP servers ignore the message.

-
4. **RARP Server Generates RARP Reply Message:** Any device on the network that is set up to act as an RARP server responds to the broadcast from the source device. It generates an *RARP Reply* using an *Opcode* value of 4. It sets the *Sender Hardware Address* and *Sender Protocol Address* to its own hardware and IP address of course, since it is the sender of the reply. It then sets the *Target Hardware Address* to the hardware address of the original source device. It looks up in a table the hardware address of the source, determines that device's IP address assignment, and puts it into the *Target Protocol Address* field.
 5. **RARP Server Sends RARP Reply Message:** The RARP server sends the *RARP Reply* message unicast to the device looking to be configured.
 6. **Source Device Processes RARP Reply Message:** The source device processes the reply from the RARP server. It then configures itself using the IP address in the *Target Protocol Address* supplied by the RARP server.

It is possible that more than one RARP server may respond to any request, if two or more are configured on any local network. The source device will typically use the first reply and discard the others.

Limitations of RARP

RARP is the earliest and most rudimentary of the class of technologies I call *host configuration protocols*, which I describe in general terms in a dedicated section. As the first of these protocols, RARP was a useful addition to the TCP/IP protocol in the early 1980s, but has several shortcomings, the most important of which are:

- ☉ **Low-Level Hardware Orientation:** RARP works using hardware broadcasts. This means that if you have a large internetwork with many physical networks, you need an RARP server on **every** network segment. Worse, if you need reliability to make sure RARP keeps running even if one RARP server goes down, you need **two** on each physical network. This makes centralized management of IP addresses difficult.
- ☉ **Manual Assignment:** RARP allows hosts to configure themselves automatically, but the RARP server must still be set up with a manual table of bindings between hardware and IP addresses. These must be maintained for each server, which is again a lot of work on an administrator.
- ☉ **Limited Information:** RARP only provides a host with its IP address. It cannot provide other needed information such as, for example, [a subnet mask or default gateway](#).

Today, the importance of host configuration has increased since the early 1980s. Many organizations assign IP addresses dynamically even for hosts that have disk storage, because of the many advantages this provides in administration and efficient use of address space. For this reason, RARP has been replaced by two more capable technologies that operate at higher layers in the TCP/IP protocol stack: [BOOTP](#) and [DHCP](#). They are discussed in [the application layer section on host configuration protocols](#).



TCP/IP Internet Layer (OSI Network Layer) Protocols

The first two layers of the [OSI Reference Model](#), the physical layer and data link layer, deal primarily with physical network details. The various LAN, WLAN and WAN protocols function primarily at these two layers to connect devices to create networks, and perform functions such as physical connection and signaling, media access control and local delivery of data between devices on the same network. Above these layers, we move beyond the hardware aspects of networking and closer to the more abstract realm of software-related network functions.

The third OSI layer is the [network layer](#). We are of course talking about networks in this Guide, and it is no coincidence that the layer bearing that name is one of the most important in comprehending how networks function. It is here that we find protocols that tie networks together to create internetworks, and also where cross-network addressing and routing are performed. The network layer is also called the *internet layer* in the [TCP/IP model](#).

In this section I provide details for the various TCP/IP protocols that reside architecturally at the TCP/IP internet layer / OSI network layer. Much of the focus here is on the all-important Internet Protocol; the section covering IP includes extensive coverage of IP version 4, IP version 6, and IP-related protocols such as IPsec, Mobile IP and IP Network Address Translation (NAT). The following three subsections cover IP support protocols such as the Internet Control Message Protocol (ICMP) and IPv6 Neighbor Discovery (ND) protocol, and the complete set of IP routing protocols.

Internet Protocol (IP/IPv4, IPng/IPv6) and IP-Related Protocols (IP NAT, IPSec, Mobile IP)

The idea of singling out any one protocol as being more important than the others in a network is kind of pointless, if you think about it. The protocols and technologies work as a team to accomplish the goal of communication across the network. Like any team, no single member can get the job done alone, no matter how good they are. Still, if we *were* to try to pick a “most valuable player” in the world of networking, a good case could be made that we have it here in this section: the TCP/IP *Internet Protocol (IP)*.

Even though it gets “second billing” in the name of the TCP/IP protocol suite, IP is in fact the “workhorse” of TCP/IP. It implements key [network-layer functions](#) including addressing, datagram handling and routing, and is the foundation upon which other TCP/IP protocols are built. Even the ones lower in the [TCP/IP architecture](#) such as [ARP](#) and [PPP](#) are easier to understand when you know how IP works. In addition to the main functions implemented by the IP protocol itself, there are also several protocols that have been developed over the years that I call “IP-Related” because they are based on IP but add new functionality or capabilities for special purposes.

In this section I provide considerable coverage of the TCP/IP Internet Protocol and to several protocols that are closely related to IP. I begin with a section that takes a general look at IP concepts and provides an overview of how IP works. I then have a large section that looks at IP version 4, the current version of the protocol that is in use on TCP/IP networks everywhere. Following this I look at the “next generation” of IP, IP version 6. I then provide sections covering three IP-related protocols: the IP Network Address Translation protocol (IP NAT), the IP Security protocol set (IPSec), and the adaptation of IP for mobile devices (Mobile IP).



Note: The primary focus in this section is on the current version of IP, IPv4, because it is the one that is in widest use at the present time. I would therefore advise reading the IPv4 section before proceeding to the other sub-sections here, unless you are already familiar with it. To avoid duplication, the section on IP version 6 is structured primarily to show how IPv6 differs from IPv4. Similarly, the sections on IP NAT, IPSec and Mobile IP build upon some of the concepts in the IPv4 section.



Background Information: If you have not yet read the [introductory section describing TCP/IP in general terms](#), you may find it helpful to review it before proceeding here.

Internet Protocol Concepts and Overview

IP is a very important protocol in internetworking; it wouldn't be an exaggeration to say that you can't really comprehend modern networking without a good understanding of IP. Unfortunately, IP can be somewhat difficult to understand. This is probably because due to its importance, a large amount of complexity has become associated with the protocol over the years, to allow it to meet the many demands placed upon it.

Before diving into the details of how IP works, I feel it is worthwhile to take a high-level look at IP and what it does. In this section I provide a brief examination of basic concepts related to the Internet Protocol and how it works. I begin with an overview of IP, how it operates in basic terms and the most important characteristics of how it does its job. I then expand on this discussion by describing the main functions of the Internet Protocol, which can be used as an introduction to the remainder of the sections that explain IP in considerably more detail. I conclude with a brief look at the history of development of IP, its versions, and how it has spawned the development of several IP-related protocols.

IP Overview and Key Operational Characteristics

The Internet Protocol (IP) is the core of the TCP/IP protocol suite and its main protocol at the [network layer](#). The network layer is primarily concerned with the delivery of data, not between devices on the same physical network, but between devices that may be on different networks that are interconnected in an arbitrary manner: an *internetwork*. IP is the mechanism by which this data is sent on TCP/IP networks. (It does have help from other protocols at the network layer too, of course!)

Let's [look at the TCP/IP layer model](#) and consider what IP does from an architectural standpoint. As the layer three protocol, it provides a service to layer four in the TCP/IP stack, represented mainly by the [TCP and UDP protocols](#). This service is to take data that has been packaged by either TCP or UDP, manipulate it as necessary, and send it out. This service is sometimes called *internetwork datagram delivery*, as shown in [Figure 54](#). As we will see, there are many details to how exactly this service is accomplished, but in a nutshell, that's what IP does: sends data from point A to point B over an internetwork of connected networks.



Key Concept: While the Internet Protocol has many functions and characteristics, it can be boiled down to one primary purpose: the delivery of datagrams across an internetwork of connected networks.

Key IP Characteristics

Of course there are a myriad of ways in which IP could have been implemented in order to accomplish this task. To understand how the designers of TCP/IP made IP work, let's take a look at the key characteristics used to describe IP and the general manner in which it operates. The Internet Protocol is said to be:

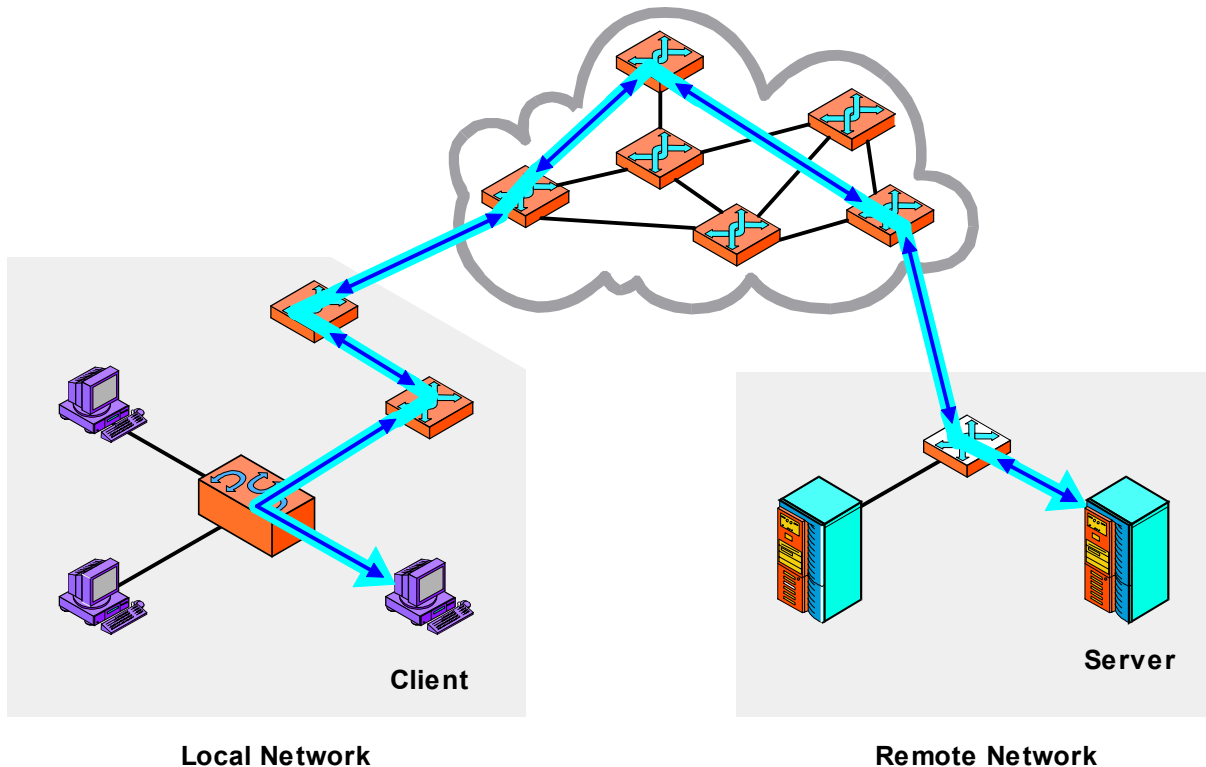

Figure 54: The Main Function of IP: Internetwork Datagram Delivery

The fundamental job of the Internet Protocol is the delivery of datagrams from one device to another over an internetwork. In this generic example, a distant client and server communicate with each other by passing IP datagrams over a series of interconnected networks.

- ☉ **Universally-Addressed:** In order to send data from point A to point B, it is necessary to ensure that devices know how to identify which device is “point B”. IP defines the addressing mechanism for the network and uses these addresses for delivery purposes.
- ☉ **Underlying-Protocol Independent:** IP is designed to allow the transmission of data across any type of underlying network that is designed to work with a TCP/IP stack. It includes provisions to allow it to adapt to the requirements of various lower-level protocols such as [Ethernet](#) or [IEEE 802.11](#). IP can also run on the [special data link protocols SLIP and PPP](#) that were created for it. An important example is IP's ability to fragment large blocks of data into smaller ones to match the size limits of physical networks, and then have the recipient reassemble the pieces again as needed.
- ☉ **Delivered Connectionlessly:** IP is a *connectionless protocol*. This means that when A wants to send data to B, it doesn't first set up a connection to B and then send the data—it just makes the datagram and sends it. [See the topic in the networking fundamentals section on connection-oriented and connectionless protocols](#) for more information on this.
- ☉ **Delivered Unreliably:** IP is said to be an “unreliable protocol”. That doesn't mean that one day your IP software will decide to go fishing rather than run your network. ☺ It does mean that when datagrams are sent from device A to device B, device A just sends each one and then moves on to the next. IP doesn't keep track of the ones it

sent. It does not provide reliability or service quality capabilities such as error protection for the data it sends (though it does on the IP header), flow control or retransmission of lost datagrams.

For this reason, IP is sometimes called a *best-effort* protocol. It does what it can to get data to where it needs to go, but “makes no guarantees” that the data will actually get there.

- ☹ **Delivered Without Acknowledgments:** In a similar manner to its unreliable nature, IP doesn't use acknowledgements. When device *B* gets a datagram from device *A*, it doesn't send back a “thank you note” to tell *A* that the datagram was received. It leaves device *A* “in the dark” so to speak.

IP's Success Despite Its Limitations

The last three characteristics in the preceding list might be enough to make you cringe, thinking that giving your data to IP would be somewhat like trusting a new car to your sixteen-year-old son. If we are going to build our entire network around this protocol, why design it so that it works without connections, doesn't guarantee that the data will get there, and has no means of acknowledging receipt of data?

The reason is simple: establishing connections, guaranteeing delivery, error-checking and similar “insurance” functions have a cost: **performance**. It takes time, computer resources and network bandwidth to perform these tasks, and they aren't always necessary for every application. Now, consider that IP carries pretty much **all** user traffic on a TCP/IP network. To build this complexity into IP would burden all traffic with this overhead whether it was needed or not.

The solution taken by the designers of TCP/IP was to exploit [the power of layering](#). If service quality features such as connections, error-checking or guaranteed delivery are required by an application, they are provided at the transport layer (or possibly, the application layer). On the other hand, applications that don't need these features can avoid using them. This is in fact the major distinction between the two TCP/IP transport layer protocols: [TCP](#) and [UDP](#). TCP is full-featured but a bit slower than UDP; UDP is spartan in its capabilities, but faster than TCP. This system is really the “best of both worlds”. And unlike your teenager with the shiny new license, it has been proven to work well in the real world. ☺

So how is datagram delivery accomplished by IP? In the following topic I discuss in more detail the main functions that IP performs to “get the job done”, so to speak.

IP Functions

In the preceding topic I described the general operation of IP and boiled down its primary job as *internetwork datagram delivery*. I also explained the most important characteristics of how IP does this job. With that as a foundation, let's now look a bit deeper, at **how** IP “gets the job done”. A good way to do this is to examine the various functions that the Internet Protocol includes.

The exact number of IP functions depends on where you “draw the line” between certain activities. For explanatory purposes, however, I view IP as having four basic functions (or more accurately, function sets):

- ① **Addressing:** In order to perform the job of delivering datagrams, IP must know where to deliver them to! For this reason, IP includes a mechanism for host addressing. Furthermore, since IP operates over internetworks, its system is designed to allow unique addressing of devices across arbitrarily large networks. It also contains a structure to facilitate the routing of datagrams to distant networks if that is required.

Since most of the other TCP/IP protocols use IP, [understanding the IP addressing scheme](#) is of vital importance to comprehending much of what goes on in TCP/IP.

- ② **Data Encapsulation and Formatting/Packaging:** As the TCP/IP network layer protocol, IP accepts data from [the transport layer protocols UDP and TCP](#). It then [encapsulates this data into an IP datagram using a special format](#) prior to transmission.
- ③ **Fragmentation and Reassembly:** IP datagrams are passed down to the data link layer for transmission on the local network. However, the maximum frame size of each physical/data-link network using IP may be different. For this reason, IP includes the ability to *fragment* IP datagrams into pieces so they can each be carried on the local network. The receiving device uses the *reassembly* function to recreate the whole IP datagram again.



Note: Some people view fragmentation and reassembly as distinct functions, though clearly they are complementary and I view them as being part of the same function.

- ④ **Routing / Indirect Delivery:** When an IP datagram must be sent to a destination on the same local network, this can be done easily using the network's underlying LAN/WLAN/WAN protocol using what is sometimes called *direct delivery*. However, in many (if not most cases) the final destination is on a distant network not directly attached to the source. In this situation the datagram must be delivered *indirectly*. This is accomplished by [routing the datagram](#) through intermediate devices (shockingly called *routers*). IP accomplishes this in concert with support from the other protocols including [ICMP](#) and the [TCP/IP gateway/routing protocols](#) such as [RIP](#) and [BGP](#).

As you continue on in this section on IP will find that I have structured the sub-sections that provide more detail on the main IP version and IP-related protocols based on these general functions.

IP History, Standards, Versions and Closely-Related Protocols

Since the Internet Protocol is really the architectural foundation for the entire TCP/IP suite, one might have expected that it was created first, and the other protocols built upon it. That's usually how one builds a structure, after all. The history of IP, however, is a bit more complex. The functions it *performs* were defined at the birth of the protocol, but IP itself didn't exist for the first few years that the protocol suite was being defined.

I explore the early days of TCP/IP in the section that overviews the suite as a whole. What is notable about the development of IP is that its functions were originally part of the [Transmission Control Protocol \(TCP\)](#). As a formal protocol, IP was “born” when an early version of TCP developed in the 1970s for predecessors of the modern Internet was split into TCP at layer four and IP at layer three. The key milestone in the development of the Internet Protocol was the publishing of RFC 791, *Internet Protocol*, in September 1981. This standard, which was a revision of the similar RFC 760 of the previous year, defined the core functionality and characteristics of the IP that has been in widespread use for the last two decades.

IP Versions and Version Numbers

The IP defined in RFC 791 was the first widely-used version of the Internet Protocol. Interestingly, however, it is not version 1 of IP but version 4! This would of course imply that there were earlier versions of the protocol at one point. Interestingly, however, there really weren't. As I mentioned above, IP was created when its functions were split out from an early version of TCP that combined both TCP and IP functions. TCP evolved through three earlier versions, and was split into TCP and IP for version 4. That version number was applied to both TCP and IP for consistency.



Key Concept: Version 4 of the *Internet Protocol* is in fact the first version that was widely deployed and is the one in current widespread use.

So, when you use IP today, you are using IP version 4, also frequently abbreviated *IPv4*. Unless otherwise qualified, it's safe to assume that “IP” means “IP version 4”—[at least for the next few years!](#) This version number is carried in the appropriate field of all IP datagrams, as described in [the topic discussing the IP datagram format](#).

Given that it was originally designed for an internetwork a tiny fraction of the size of our current Internet, IPv4 has proven itself remarkably capable. Various additions and changes have been made over time to how IP is used, especially with respect to addressing, but the core protocol is basically what it was in the early 1980s. There's good reason for this: changing something as fundamental as IP requires a great deal of development effort and also introduces complexities during transition.

Despite how well IPv4 has served us, it was recognized that for various reasons a new version of IP would eventually be required. Due to the difficulties associated with making such an important change, development of this new version of IP has actually been underway since the mid-1990s. This new version of IP is formally called *Internet Protocol version 6 (IPv6)* and also sometimes referred to as *IP Next Generation* or *IPng*. I discuss the reasons why IPv6 was developed and how it differs from IPv4 in considerable detail in [the IPv6 section of this Guide](#).

A natural question at this point of course is: what happened to version 5 of IP? The answer is: it doesn't exist. While this may seem confusing, version 5 was in fact intentionally skipped to **avoid** confusion, or at least to rectify it. The problem with version 5 relates to an experimental TCP/IP protocol called the *Internet Stream Protocol, Version 2*, originally defined in RFC 1190. This protocol was originally seen by some as being a peer of IP at the Internet Layer in the TCP/IP architecture, and in its standard, these packets were assigned IP version 5 to differentiate them from “normal” IP packets (version 4). This protocol apparently never went anywhere, but to be absolutely sure that there would be no confusion, version 5 was skipped over in favor of version 6.

IP-Related Protocols

In addition to our “old” and “new” versions of IP, there are several protocols that I call *IP-related*. They are not parts of IP proper, but protocols that add to or expand on the capabilities of IP functions for special circumstances. These are:

- **IP Network Address Translation (IP NAT / NAT):** [This protocol provides IP address translation capabilities](#) to allow private networks to be interfaced to public networks in a flexible manner. It allows public IP addresses to be shared and improves security by making it more difficult for hosts on the public network to gain unauthorized access to hosts. It is commonly called just “NAT” but it works on IP addresses so I think “IP NAT” is more clear.
- **IP Security (IPSec):** [Defines a set of sub-protocols that provide a mechanism for secure transfer of data using IP.](#) IPSec is rapidly growing in popularity as a security protocol to enable virtual private networks (VPNs).
- **Mobile IP:** A protocol that addresses some of the difficulties associated with using IP on computers that frequently move from one network to another. [It provides a mechanism to allow data to be automatically routed to a mobile host](#) (such as a notebook computer) without requiring the device's IP address to be constantly re-configured.

The remainder of the discussion of IP is divided into five sections corresponding to [IPv4](#), [IPv6](#), [IP NAT](#), [IPSec](#) and [Mobile IP](#).



Internet Protocol Version 4 (IP, IPv4)

Even though the name seems to imply that it's the fourth iteration of the key Internet Protocol, [version 4 of IP was the first that was widely used](#) in modern TCP/IP. *IPv4*, as it is sometimes called to differentiate it from the newer [IPv6](#), is the Internet Protocol version in use on the Internet today, and an implementation of the protocol is running on hundreds of millions of computers. It provides the basic datagram delivery capabilities upon which all of TCP/IP functions, and it has proven its quality in use over a period of more than two decades.

In this section I provide extensive detail on the operation of the current version of the Internet Protocol, IPv4. There are four main subsections, which represent the four main functions of IP. The first subsection provides a comprehensive discussion of IP addressing. The second discusses how data is encoded and formatted into IP datagrams for transmission. The third describes datagram size issues and how fragmentation and reassembly are used to convey large datagrams over networks designed to carry small frames. The last subsection covers matters related to the delivery and routing of IP datagrams. After the four main subsections I conclude our look at IPv4 with an overview of IP multicasting, which is used for delivering a single datagram to more than one recipient.



Related Information: As the title of this section implies, our coverage here is limited to IP version 4; version 6 is covered in its separate section, as are the IP-related protocols. That said, some of the principles here will also apply to [IPv6](#), [IP NAT](#), [IPSec](#) or [Mobile IP](#) in a limited manner. For simplicity, in this section I use the simpler designation “IP” rather than “IPv4”, except where the longer abbreviation is required for clarity.

IP Addressing

The primary job of IP is delivering messages between devices, and like any good delivery service, it can't do its job too well if it doesn't know where the recipients are located. Obviously then, one of the most important functions of the Internet Protocol is *addressing*. IP addresses are used not only to uniquely identify IP addresses but to facilitate the [routing of IP datagrams](#) over internetworks. They are used and referred to extensively in TCP/IP networking.

In this section I provide a comprehensive explanation of the issues and techniques associated with IP addressing. There are five subsections. The first provides an overview of IP addressing concepts and issues. The second discusses the original class-based (“classful”) IP addressing scheme and how the different classes work. The third and fourth subsections are devoted to IP subnets and subnet addressing. This includes a discussion of subnetting concepts and also a thorough illustration of practical step-by-step subnetting. The last subsection describes the new classless addressing system, also sometimes called “supernetting”.



Note: This section contains over 30 subsections and individual topics. The sheer size of this discussion may surprise you; it certainly surprised me when I set out to organize it. ☺ There are two main reasons why I felt that so much detail was necessary. The first is that really understanding both the concepts and practice of IP addressing is **essential** to having any substantial comprehension of TCP/IP operation as a whole, so I didn't want to skimp on anything. The second is that IP addressing has become somewhat complicated. There is more than one way that IP networks are configured, and it's essential to explore them all for a complete coverage of the subject.

IP Addressing Concepts and Issues

Even though the original IP addressing scheme was relatively simple, it has become complex over time as changes have been made to it to allow it to deal with various addressing requirements. The more advanced styles of IP addressing, such as [subnetting](#) and [classless addressing](#), are the ones used most in modern networks. However, they can be a bit confusing to understand. To help make sense of them we must start at the beginning with a discussion of the fundamentals of IP addressing.

In this section I begin our larger exploration of IP addressing by explaining the key concepts and issues behind it. I begin with an overview of IP addressing and discussion of what it is all about in general terms. I describe the size of IP addresses, the concept of its “address space” and the notation usually used for IP addresses. I provide basic information on the structure of an IP address and how it is divided into a network identifier and host identifier. I then describe the different types of IP addresses and the additional information such as a subnet mask and default gateway that often accompanies an IP address on larger networks. I provide a brief description of how multiple addresses are sometimes assigned to single devices and why. I conclude with a description of the process by which public IP addresses are registered and managed, and the organizations that do this work for the global Internet.



Background Information: If you are not familiar with at least the basics of how binary numbers work, and also with how to convert between binary and decimal numbers, I'd recommend reading [the background section on data representation and the mathematics of computing](#) before you proceed here. You can probably get by in this particular section without that knowledge, but [you'll need it anyway when we proceed to subnetting](#), so you might as well get familiar now.



Note: Remember that most operating systems have a calculator program that incorporates scientific functions, including conversions between binary, decimal and hexadecimal numbers.

IP Addressing Overview and Fundamentals

In [the introduction of this section](#), I mentioned that IP addressing is important because it facilitates the primary function of the Internet Protocol—the delivery of datagrams across an internetwork. Understanding this in more detail requires us to examine a few different but essential issues related to how IP and its addresses operate.

IP Address Functions: Identification and Routing

The first point that bears making is that there are actually two different functions of the IP address:

-
- 🕒 **Network Interface Identification:** Like a street address, the IP address provides unique identification of the interface between a device and the network. This is required to ensure that the datagram is delivered to the correct recipients.
 - 🕒 **Routing:** When the source and destination of an IP datagram are not on the same network, the datagram must be delivered “indirectly” using intermediate systems, a process called *routing*. The IP address is an essential part of [the system used to route datagrams](#).

You may have noticed a couple of things about this short list. One is that I said the IP address identifies the **network interface**—not that it identifies the **device** itself. This distinction is important because it underscores the concept that IP is oriented around connections to a large “virtual network” at layer three, which can span multiple physical networks. Some devices, such as routers, will have more than one network connection: they must, in order to take datagrams from one network and route them onto another. This means they will also have more than one IP address, one per connection.

You might also find it curious that I said the IP address facilitates routing. How can it do that? The answer is that the addressing system is designed with [a structure that can be interpreted to allow routers to determine what to do with a datagram](#) based on the values in the address. Numbers related to the IP address, such as the subnet mask when subnetting is used, support this function.

Let’s now look at some other important issues and characteristics associated with IP addresses in general terms.

Number of IP Addresses Per Device

Any device that has data sent to it at the network layer will have at least one IP address: one per network interface. As I mentioned above, this means that normal hosts such as computers and network-capable printers usually get one IP address, while routers get more than one IP address. Some special hosts may have more than one IP address if they are [multihomed](#)—connected to more than one network.

Lower-level network interconnection devices such as repeaters, bridges and switches don’t require an IP address because they pass traffic based on layer two (data link layer) addresses. Network segments connected by bridges and switches form a single broadcast domain and any devices on them can send data to each other directly without routing. To the Internet Protocol, these devices are “invisible”, they are no more significant than the wires that connect devices together (with a couple of exceptions). Such devices may, however, optionally have an IP address for management purposes. In this regard, they are acting like a regular host on the network. See [Figure 55](#) for an illustration.

Address Uniqueness

Each IP address on a single internetwork must be unique. This seems rather obvious (although there are exceptions in IPv6, in the form of special [anycast addresses!](#))

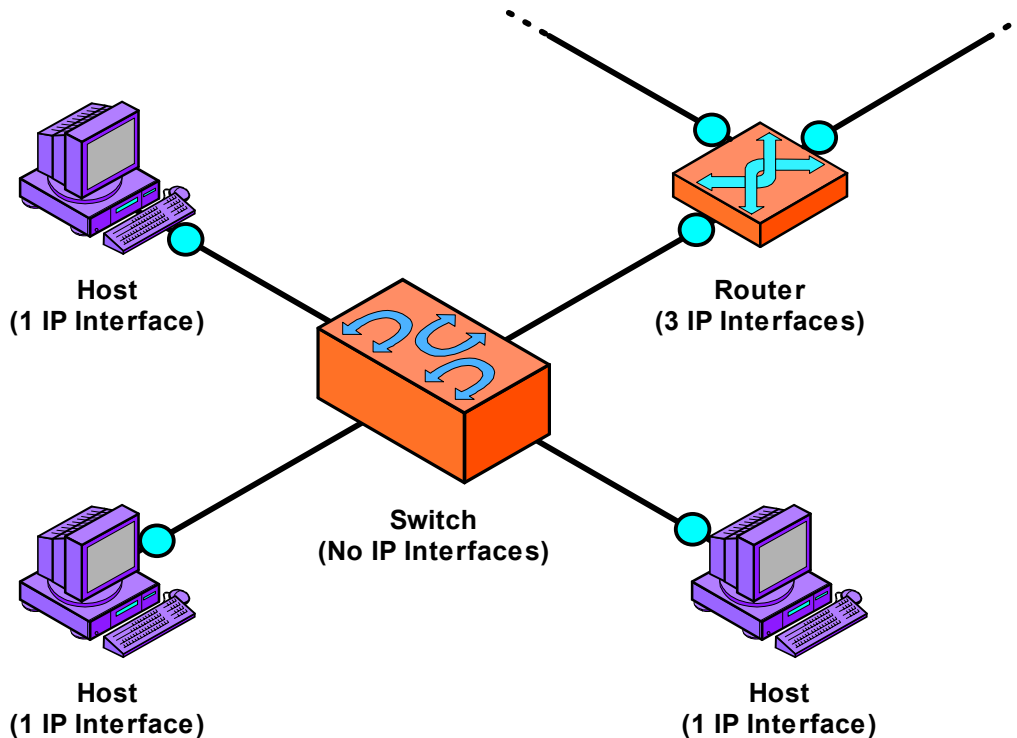

Figure 55: IP Interfaces for Common Network Devices

This illustration shows the IP interfaces of a few common LAN devices as small cyan circles. Each regular host has one interface, while the router that serves this LAN has three, since it connects to three different networks. Note that the LAN switch has no IP interfaces; it connects the hosts and router at layer two. Also see [Figure 59](#), which shows the IP interfaces of devices in a more complex configuration.

Network-Specificity of IP Addresses

Since IP addresses represent network interfaces and are used for routing, the IP address is specific to the network to which it is connected. If the device moves to a new network, the IP address will usually have to change as well. For the full reason why, see [the discussion of basic IP address structure](#). This issue was a primary motivation for the creation of [Mobile IP](#).

Contrasting IP Addresses and Data Link Layer Addresses

IP addresses are used for network-layer data delivery across an internetwork. This makes IP addresses quite different from the data link layer address of a device, such as its [Ethernet MAC address](#). (In TCP/IP parlance these are sometimes called *physical addresses* or *hardware addresses*.) At the network layer, a single datagram may be sent “from device A to device B”. However, the actual delivery of the datagram may require that it passes through a dozen or more physical devices, if A and B are not on the same network.

It is also necessary to provide a function that maps between IP and data link layer addresses. In TCP/IP this is the job of the [Address Resolution Protocol \(ARP\)](#).

IP Address Datagram Delivery Issues

In a physical network such as an Ethernet, the MAC address is all the information needed to send data between devices. In contrast, an IP address represents only the final delivery point of the datagram. The route taken depends on the characteristics of the network paths between the source and destination devices. It is even possible that there may not be a route between any two devices, which means two devices cannot exchange data even if they know each other's addresses!

Private and Public IP Network Addresses

There are two distinct ways that a network can be set up with IP addresses. On a *private network* a single organization controls the assignment of the addresses for all devices; they have pretty much absolute control to do what they wish in selecting numbers as long as each address is unique. In contrast, on a *public network* a mechanism is required to ensure both that organizations don't use overlapping addresses and also to enable efficient routing of data between organizations. The best-known example of this is of course the Internet, where [public IP registration and management facilities](#) have been created to address this issue. There are also advanced techniques now such as [IP Network Address Translation](#) that allow a network using private addresses to be interfaced to a public TCP/IP network.

IP Address Configuration

There are two basic ways that IP addresses can be configured. In a *static configuration* setup, each device is manually configured with an IP address that doesn't change. This is fine for small networks but quickly becomes an administrative nightmare in larger networks when changes are required. The alternative, *dynamic configuration*, allows IP addresses to be assigned to devices and changed under software control. The two [host configuration protocols](#), [BOOTP](#) and [DHCP](#), were created to fill this latter function.

Unicast, Multicast and Broadcast Addressing

Provision is included in the IP addressing scheme for [all three basic types of addressing](#).



Key Concept: IP addresses serve the dual function of device identification and routing. Each network interface requires one IP address, which is network-specific. IP addresses can be either statically or dynamically allocated, and come in unicast, multicast and broadcast forms.

The topics that follow in this section, and the other sections in our discussion of IP, expand upon these concepts with more particulars.

IP Address Size, Address Space and "Dotted Decimal" Notation

Now that we have looked at [the general issues and characteristics associated with IP addresses](#), it's time to get past the introductions and dig into the "meat" of our IP address discussion. Let's start by looking at the physical construction and size of the IP address and how it is referred to and used.

IP Address Size and Binary Notation

At its simplest, the IP address is just a 32-bit [binary number](#): a set of 32 ones or zeroes. At the lowest levels computers always work in binary and this also applies to networking hardware and software. While different meanings are ascribed to different bits in the address as we shall soon see, the address itself is just this 32-digit binary number.

Humans don't work too well with binary numbers, because they are long and complicated, and the use of only two digits makes them hard to differentiate. (Quick, which of these is larger: 11100011010100101001100110110001 or 1110001101010010100110110110001? ☺) For this reason, when we use IP addresses we don't work with them in binary except when absolutely necessary.

The first thing that humans would naturally do with a long string of bits is to split it into four eight-bit octets (or bytes, [even though the two aren't technically the same](#)), to make it more manageable. So, 1110001101010010100110110110001 would become "11100011 - 01010010 - 10011101 - 10110001". Then, we could convert each of those octets into a more manageable two-digit [hexadecimal number](#), to yield the following: "E3 - 52 - 9D - B1". This is in fact the notation used for [IEEE 802 MAC addresses](#), except that they are 48 bits long so they have six two-digit hex numbers, and they are usually separated by colons, not dashes as I used here.

IP Address "Dotted Decimal" Notation

Most people still find hexadecimal a bit difficult to work with. So IP addresses are normally expressed with each octet of 8 bits converted to a decimal number and the octets separated by a period (a "dot"). Thus, the example above would become *227.82.157.177*, as shown in [Figure 56](#). This is usually called *dotted decimal notation* for rather obvious reasons. Each of the octets in an IP address can take on the values from 0 to 255 (not 1 to 256, note!) so the lowest value is theoretically 0.0.0.0 and the highest is 255.255.255.255.



Key Concept: IP addresses are 32-bit binary numbers, which can be expressed in binary, hexadecimal or decimal form. Most commonly, they are expressed by dividing the 32 bits into four bytes and converting each to decimal, then separating these numbers with dots to create *dotted decimal notation*.

Dotted decimal notation provides a convenient way to work with IP addresses when communicating amongst humans. Never forget that to the computers, the IP address is always a 32-bit binary number; the importance of this will come in when we look at how [the IP address is logically divided into components](#) in the next topic, as well as when we examine techniques that manipulate IP addresses, such as [subnetting](#).

	0	8	16	24	32
Binary	11100011	01010010	10011101	10110001	
Hexadecimal	E3	52	9D	B1	
Dotted Decimal	227	82	157	177	

Figure 56: IP Address Binary, Hexadecimal and Dotted Decimal Representations

The binary, hexadecimal and decimal representations of an IP address are all equivalent.

IP Address Space

Since the IP address is 32 bits wide, this provides us with a theoretical *address space* of 2^{32} , or 4,294,967,296 addresses. This seems like quite a lot of addresses! And in some ways it is. However, as we will see, due to how IP addresses are structured and allocated, not every one of those addresses can actually be used. One of the unfortunate legacies of the fact that IP was originally created on a rather small internetwork is that decisions were made that “wasted” much of the address space. For example, all IP addresses starting with “127” in the first octet are reserved for the [loopback function](#). Just this one decision makes 1/256th of the total number of addresses, or 16,277,216 addresses, no longer available. There are also other ways that the IP address space was not “conserved”, which caused difficulty as the Internet grew in size. [We'll see more about this in the section on “classful addressing](#).



Key Concept: Since IP addresses are 32 bits long, the total *address space* of IPv4 is 2^{32} or 4,294,967,296 addresses. However, not all of these addresses can be used, for a variety of reasons.

This IP address space dictates the limit on the number of addressable interfaces in *each* IP internetwork. So, if you have a private network you can in theory have 4 billion plus addresses. However, in a public network such as the Internet, all devices must share the available address space. Techniques such as [CIDR \(“supernetting”\)](#) and [Network Address Translation \(NAT\)](#) were designed in part to more efficiently utilize the existing Internet IP address space. Of course, [IP version 6](#) expands the IP address size from 32 bits all the way up to 128, which increases the address space to a ridiculously large number and makes the entire matter of address space size moot.

(Incidentally, the second binary number is the larger one.)

IP Basic Address Structure and Main Components: Network ID and Host ID

As I mentioned in the IP addressing overview, one of the ways that IP addresses are used is to facilitate [the routing of datagrams in an IP internet](#). This is made possible because of the way that IP addresses are structured, and how that structure is interpreted by network routers.

Internet IP Address Structure

As we just saw, each version 4 IP address is 32 bits long. When we refer to the IP address we use a dotted-decimal notation, while the computer converts this into binary. However, even though these sets of 32 bits are considered a single “entity”, they have an internal structure containing two components:

- 🕒 **Network Identifier (Network ID):** A certain number of bits, starting from the left-most bit, is used to identify the network where the host or other network interface is located. This is also sometimes called the *network prefix* or even just the *prefix*.
- 🕒 **Host Identifier (Host ID):** The remainder of the bits are used to identify the host on the network.



Note: By convention, IP devices are often called *hosts* for simplicity, as I do throughout this Guide. Even though each host *usually* has a single IP address, remember that IP addresses are strictly associated with network-layer network interfaces, not physical devices, and a device may therefore have more than one IP address.

As you can see in [Figure 57](#), this really is a fairly simple concept; it's the same idea as the structure used for phone numbers in North America. The telephone number (401) 555-7777 is a ten-digit number usually referred to as a single “phone number”. However, it has a structure. In particular, it has an area code (“401”) and a local number (“555-7777”).

Implications of Including the Network ID in IP Addresses

The fact that the network identifier is contained in the IP address is what partially facilitates the routing of IP datagrams when the address is known. Routers look at the network portion of the IP address to determine first of all if the destination IP address is on the same network as the host IP address. Then routing decisions are made based on information the routers keep about where various networks are located. Again, this is conceptually similar to how the area code is used by the equivalent of “routers” in the phone network to switch telephone calls. The host portion of the address is used by devices on the local portion of the network.

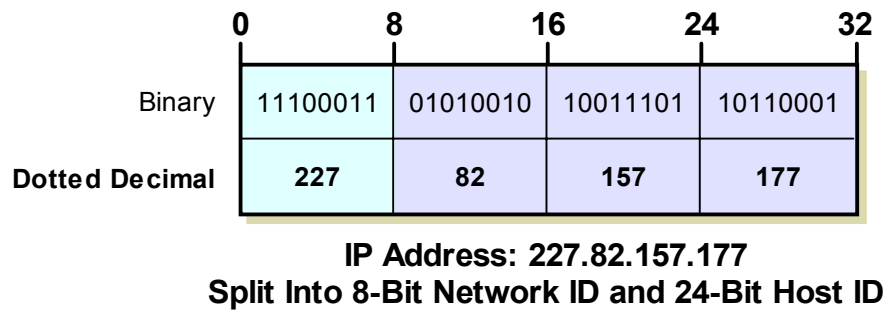

Figure 57: Basic IP Address Division: Network ID and Host ID

The fundamental division of the bits of an IP address is into a network ID and host ID. Here, the network ID is 8 bits long, shown in cyan, and the host ID is 24 bits in length.

Since the IP address can be split into network ID and host ID components, it is also possible to use either one or the other by itself, depending on context. [These addresses are assigned special meanings](#). For example, if the network ID is used with all ones as the host ID, this indicates a broadcast to the entire network. Similarly, if the host ID is used by itself with all zeroes for the network ID, this implies an IP address sent to the host of that ID on “the local network”, whatever that might be.

It is the inclusion of the network identifier in the IP address of each host on the network that causes the IP addresses to be network-specific. If you move a device from one network to a different one the network ID must change to that of the new network. Therefore, the IP address must change as well. [This is an unfortunate drawback that shows up most commonly when dealing with mobile devices](#).

Location of the Division Between Network ID and Host ID

One difference between IP addresses and phone numbers is that the dividing point between the bits used to identify the network and those that identify the host isn't fixed. It depends on the nature of the address, the type of addressing being used, and other factors. Let's take the example from the last topic, 227.82.157.177. It is possible to divide this into a network identifier of “227.82” and a host identifier of “157.177”. Alternately, the network identifier might be “227” and the host identifier “82.157.177” within that network.

To express the network and host identifiers as 32-bit addresses, we add zeroes to replace the missing “pieces”. In the latter example just above, the address of the network becomes “227.0.0.0” and the address of the host “0.82.157.177”. (In practice, network addresses of this sort are routinely seen with the added zeroes; network IDs are not as often seen in 32-bit form this way.)

Lest you think from these examples that the division must always be between whole octets of the address, it's also possible to divide it in the middle of an octet. For example, we could split the IP address 227.82.157.177 so there were 20 bits for the network ID and 12 bits for

the host ID. The process is the same, but determining the dotted decimal ID values is more tricky because here, the “157” is “split” into two binary numbers. The results are “227.82.144.0” for the network ID and “0.0.0.13.177” for the host ID, as shown in [Figure 58](#).

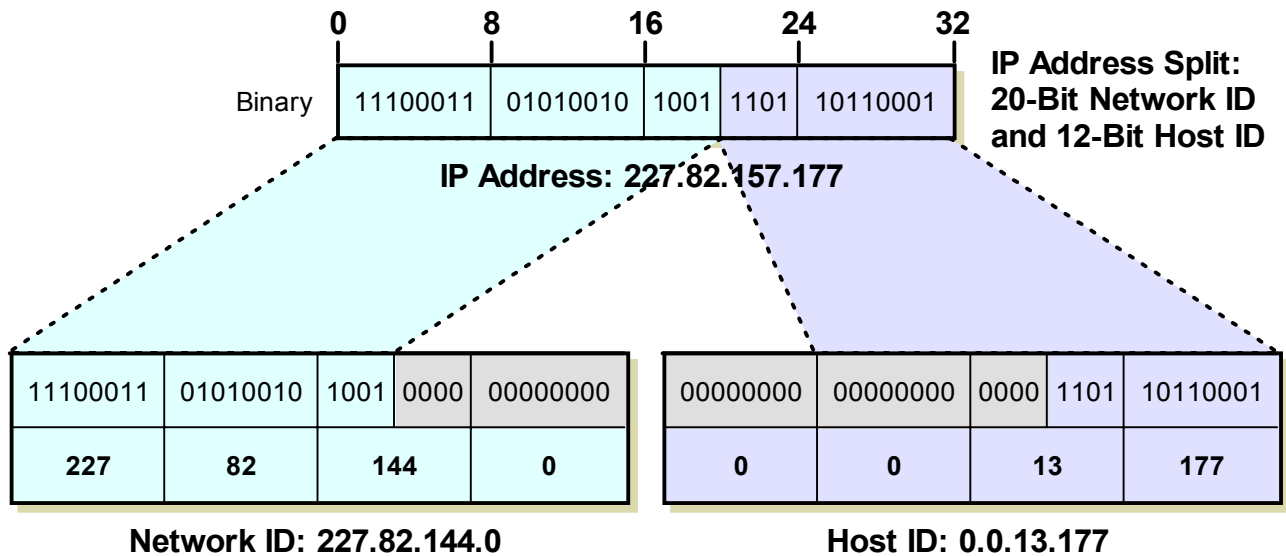

Figure 58: Mid-Octet IP Address Division

Since IP addresses are normally expressed as four dotted-decimal numbers, educational resources often show the division between the Network ID and Host ID occurring on an octet boundary. However, it’s essential to remember that the dividing point often appears in the middle of one of these eight-bit numbers. In this example, the Network ID is 20 bits long and the Host ID 12 bits long. This results in the third number of the original IP address, 157, being split into 144 and 13.

The place where the “line is drawn” between the network ID and the host ID must be known in order for devices such as routers to know how to interpret the address. This information is conveyed either implicitly or explicitly depending on the type of IP addressing in use. [I describe this in the following topic.](#)



Key Concept: The basic structure of an IP address consists of two components: the *network ID* and *host ID*. The dividing point of the 32-bit address is not fixed, but rather, depends on a number of factors, and can occur in a variety of places, including in the middle of a dotted-decimal octet.

IP Addressing Categories (Classful, Subnetted and Classless) and IP Address Adjuncts (Subnet Mask and Default Gateway)

The [preceding topic](#) illustrated how the fundamental division of the 32 bits in an IP address is into the network identifier (network ID) and host identifier (host ID). The network ID is used for routing purposes while the host ID uniquely identifies each network interface on

the network. In order for devices to know how to use IP addresses on the network they must be able to tell which bits are used for each ID. However, the “dividing line” is not predefined. It depends on the type of addressing used in the network.

IP Addressing Scheme Categories

Understanding how these IDs are determined leads us into a larger discussion of the three main categories of IP addressing schemes. Each of these uses a slightly different system of indicating where in the IP address the host ID is found.

Conventional (“Classful”) Addressing

The [original IP addressing scheme](#) is set up so that the dividing line occurs only in one of a few locations: on octet boundaries. Three main classes of addresses, A, B and C are differentiated based on how many octets are used for the network ID and how many for the host ID. For example, class C addresses devote 24 bits to the network ID and 8 to the host ID. This type of addressing is now often referred to by the made-up word “classful” to differentiate it from newer “classless” scheme.

This most basic addressing type uses the simplest method to divide the network and host identifiers: the class, and therefore the dividing point, are encoded into the first few bits of each address. Routers can tell from these bits which octets belong to which identifier.

Subnetted “Classful” Addressing

In [the subnet addressing system](#), the two-tier network/host division of the IP address is made into a three-tier system by taking some number of bits from a class A, B or C host ID and using them for a *subnet identifier*. The network ID is unchanged. The *subnet ID* is used for routing within the different subnetworks that constitute a complete network, providing extra flexibility for administrators. For example, consider a class C address that normally uses the first 24 bits for the network ID and remaining 8 bits for the host ID. The host ID can be split into, say, 3 bits for a subnet ID and 5 for the host ID.

This system is based on the original “classful” scheme, so the dividing line between the network ID and “full” host ID is based on the first few bits of the address as before. The dividing line between the subnet ID and the “sub-host” ID is indicated by a 32-bit number called a *subnet mask*. In the example above, the subnet mask would be 27 ones followed by 5 zeroes—the zeroes indicate what part of the address is the host. In dotted decimal notation, this would be 255.255.255.224.

Classless Addressing

In [the classless system](#), the classes of the original IP addressing scheme are tossed out the window. The division between the network ID and host ID can occur at an arbitrary point, not just on octet boundaries like in the “classful” scheme.

The dividing point is indicated by putting the number of bits used for the network ID, called the *prefix length*, after the address (recall that the network ID bits are also sometimes called the *network prefix*, so the network ID size is the prefix length). For example, if 227.82.157.177 is part of a network where the first 27 bits are used for the network ID, that network would be specified as 227.82.157.160/27. The “/27” is conceptually the same as the 255.255.255.224 subnet mask, since it has 27 one bits followed by 5 zeroes.



Key Concept: An essential factor in determining how an IP address is interpreted is the addressing scheme in which it is used. The three methods, arranged in increasing order of age, complexity and flexibility, are “*classful*” addressing, subnetted “*classful*” addressing, and *classless* addressing.

Did I just confuse the heck out of you? Sorry—and don't worry. I'm simply introducing the concepts of “classful”, subnetted and classless addressing and showing you how they impact the way the IP address is interpreted. This means of necessity that I have greatly summarized important concepts here. All three methods are explained in their own sections in full detail.

IP Address Adjuncts: Subnet Mask and Default Gateway

As you can see, in the original “classful” scheme the division between network ID and host ID is implied. However, if either subnetting or classless addressing is used, then the subnet mask or “slash number” are required to fully qualify the address. These numbers are considered adjuncts to the IP address and usually mentioned “in the same breath” as the address itself, because without them, it is not possible to know where the network ID ends and the host ID begins.

One other number that is often specified along with the IP address for a device is the *default gateway* identifier. In simplest terms, this is the IP address of the router that provides default routing functions for a particular device. When a device on an IP network wants to send a datagram to a device it can't see on its local IP network, it sends it to the default gateway which takes care of routing functions. Without this, each IP device would also have to have knowledge of routing functions and routes, which would be inefficient. See the sections on [routing concepts](#) and [TCP/IP routing protocols](#) for more information.

Number of IP Addresses and Multihoming

Each network interface on an IP internetwork has a separate IP address. In a classical network, each regular computer, usually called a *host*, attaches to the network in exactly only one place, so it will have only one IP address. This is what most of us are familiar with when using an IP network (and is also why most people use the term “host” when they really mean “network interface”).

If a device has more than one interface to the internetwork, it will have more than one IP address. The most obvious case where this occurs is with routers, which connect together different networks and thus must have an IP address for the interface on each one. It is also possible for hosts to have more than one IP address, however. Such a device is sometimes said to be *multihomed*.

Multihoming Methods

There are two ways that a host can be multihomed:

- ① **Two Or More Interfaces To The Same Network:** Devices such as servers or high-powered workstations may be equipped with two physical interfaces to the same network for performance and/or reliability reasons. They will have two IP addresses on the same network with the same network ID.
- ② **Interfaces To Two Or More Different Networks:** Devices may have multiple interfaces to different networks. The IP addresses will typically have different network IDs in them.

Figure 59 shows examples of both types of multihomed device. Of course, these could be combined, with a host having two connections to one network and a third to another network. There are also some other “special cases”, such as a host with a single network connection having multiple IP address aliases.



Note: When subnetting is used the same distinction can be made between multihoming to the same subnet or a different subnet.

Using a Multihomed Host as a Router

Now, let's consider the second case. If a host has interfaces to two or more different networks, then could it not pass IP datagrams between them? Of course, it certainly could, if it had the right software running on it. If it does this, wouldn't that make the host a router, of sorts? In fact, that is exactly the case! A multihomed host with interfaces to two networks can use software to function as a router. This is sometimes called *software routing*.

Using a host as a router has certain advantages and disadvantages compared to a hardware router. A server that is multihomed can perform routing functions and also, well, act as a server. A dedicated hardware router is designed for the job of routing and usually will be more efficient than a software program running on a host.



Key Concept: A host with more than one IP network interface is said to be *multihomed*. A multihomed device can have either multiple connections to the same network or to different networks, or both. A host connected to two networks can be configured to function as a router.

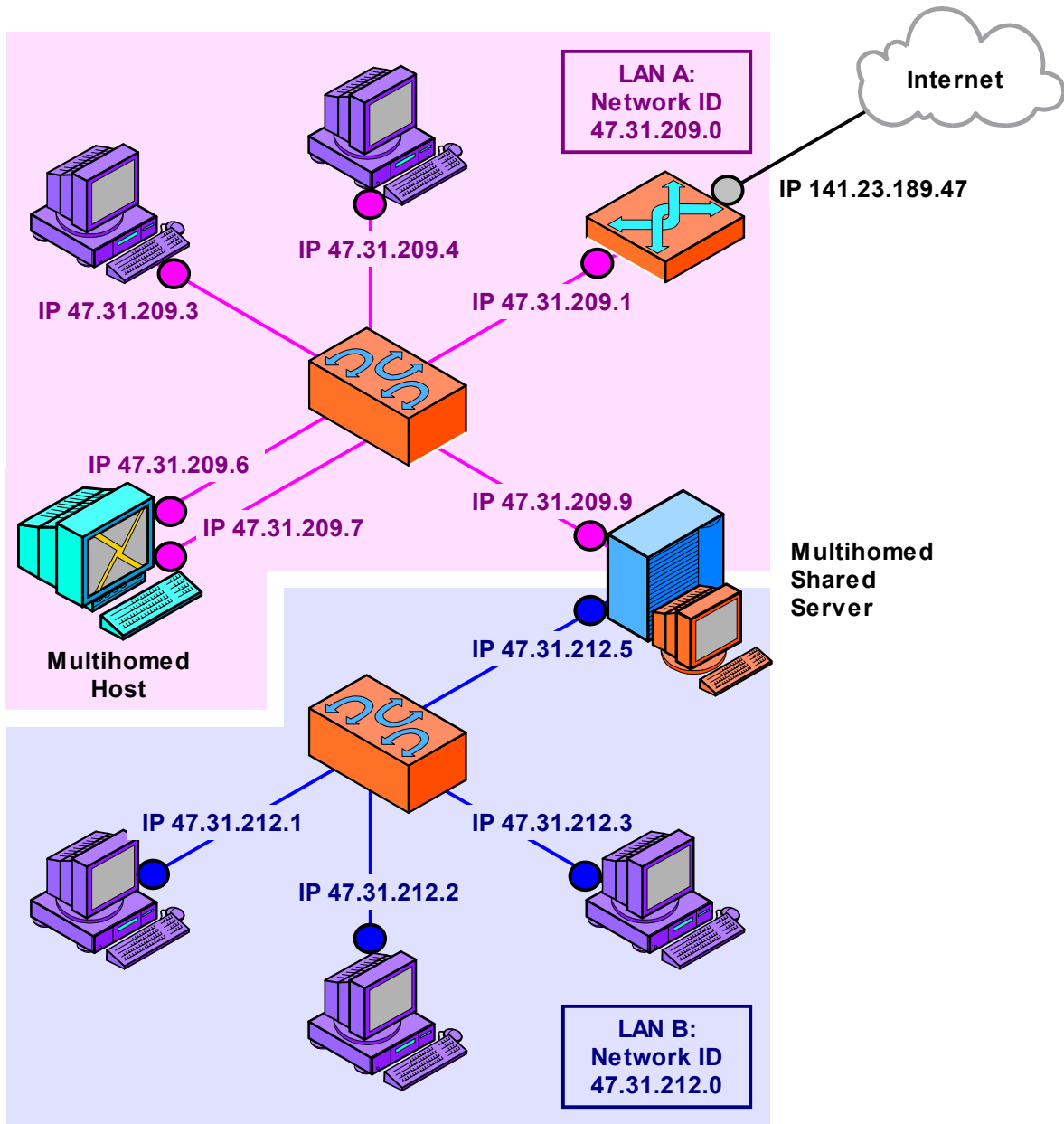

Figure 59: Multihomed Devices On An IP Internetwork

This internetwork consists of two LANs, A (shown in purple) and B (shown in blue). LAN A has a multihomed workstation, shown with two IP network interface “circles”. The two LANs are connected together through a multihomed, shared server, that has been configured to route traffic between them. Note that this server also handles all traffic passing between LAN B and the Internet (since the Internet connection is in LAN A only.)

Popularity of Multihoming

Multihoming was once considered a fairly “esoteric” application, but has become more common in recent years. This is also true of multihoming on different networks for software routing use. In fact, you may be doing this in your home without realizing it!

Suppose you have two PCs networked together and a single phone line to connect to the Internet. One computer dials up to your Internet Service Provider, and runs software such as Microsoft's Internet Connection Sharing (ICS) to let the other computer access the Internet. Millions of people do this every day—they have a multihomed system (the one connecting to the Internet and the other PC) with ICS acting in the role of a software router (though there are some technical differences between ICS and a true router, of course.)

IP Address Management and Assignment Methods and Authorities

What would happen if you told someone that you lived at 34 Elm Street, and when that person turned onto your road found four different houses with the number “34” on them? They'd probably find your place eventually but wouldn't be too pleased. Neither would you or your mail carrier. ☺ And all of you folks are much smarter than computers. Where I am going with this is that like street addresses, IP addresses must be unique for them to be useful.

The Need for Centralized Registration of IP Addresses

Since IP datagrams are sent only within the confines of the IP internetwork, they must be unique within each internetwork. If you are a company with your own private internetwork, this isn't really a big problem. Whoever is in charge of maintaining the internetwork keeps a list of what numbers have been used where and makes sure that no two devices are given the same address. However, what happens in a public network with many different organizations? Here, it is essential that the IP address space be managed across the organizations to ensure that they use different addresses. It's not feasible to have each organization coordinate its activities with each other one. Therefore, some sort of centralized *management authority* is required.

At the same time that we need someone to ensure that there are no conflicts in address assignment, we don't want every user of the network to have to go to this central authority every time they need to make a change to their network. It makes more sense to have the authority assign numbers in blocks or chunks to organizations based on the number of devices they want to connect to the network. The organizations can manage those blocks as they see fit, and the authority's job is made easier because it deals in blocks instead of billions of individual addresses and machines.

The Original IP Address Authority: IANA

The Internet is of course “the” big IP internetwork, and requires this coordination task to be performed for millions of organizations worldwide. The job of managing IP address assignment on the Internet was originally carried out by a single organization: the [Internet Assigned Number Authority \(IANA\)](#). IANA was responsible for allocating IP addresses, along with other important centralized coordination functions such as managing universal parameters used for TCP/IP protocols. In the late 1990s, a new organization called the *Internet Corporation for Assigned Names and Numbers (ICANN)* was created. ICANN now oversees the IP address assignment task of IANA, as well as managing other tasks such as [DNS name registration](#).

Modern IP Address Registration and Authorities

IP addresses were originally allocated directly to organizations. The [original IP addressing scheme was based on classes](#), and so IANA would assign addresses in Class A, Class B and Class C blocks. Today, addressing is classless, using [CIDR's hierarchical addressing scheme](#). IANA doesn't assign addresses directly, but rather delegates them to regional Internet registries (RIRs). These are APNIC, ARIN, LACNIC, and RIPE NCC. Each RIR can in turn delegate blocks of addresses to lower-level registries such as national Internet registries (NIRs) and local Internet registries (LIRs).

Eventually, blocks of addresses are obtained by Internet Service Providers (ISPs) for distribution to end-user organizations. Some of the ISP's customers are "end-user" organizations, but others are (smaller) ISPs themselves. They can in turn use or "delegate" the addresses in their blocks. This can continue for several stages in a hierarchical fashion. This arrangement helps ensure that IP addresses are assigned and used in the most efficient manner possible. [See the section on CIDR for more information on how this works.](#)

IANA, ICANN and the RIRs are responsible for more than just IP address allocation, though I have concentrated on IP addresses here for obvious reasons. For more general information on IANA, ICANN, APNIC, ARIN, LACNIC and RIPE NCC, try a can of alphabet soup... or [the topic on Internet registration authorities](#). ☺



IP "Classful" (Conventional) Addressing

The [prior section on IP addressing concepts](#) describes the three different ways that IP addresses are assigned in TCP/IP. The original addressing method worked by dividing the IP address space into chunks of different sizes called *classes* and assigning blocks of addresses to organizations from these classes based on the size and requirements of the organization. In the early 1980s, when the Internet was in its infancy, this conventional system really had no name; today, to contrast it to the newer “classless” addressing scheme, it is usually called the “*classful*” IP addressing system.

In this section I describe the first scheme used for IP addressing: so-called “classful” IP addressing. I begin with an overview of the concept and general description of the different classes. I discuss the network and host IDs and address ranges associated with the different classes. I discuss the “capacities” of each of the commonly-used classes, meaning how many networks belong to each, and how many hosts each network can contain. I discuss the special meanings assigned to certain IP address patterns, and also the special ranges reserved for private IP addressing, loopback functions, and multicasting. I conclude with a discussion of the problems with this type of addressing, which led to it eventually being abandoned in favor of subnetting, and eventually, classless assignment of the IP address space.

I should note that the “classful” addressing scheme has now been replaced on the Internet by the newer [classless addressing system described later in this section](#). However, I think it is still important to understand how this original system operates, as it forms the foundation upon which the more sophisticated addressing mechanisms were built. Just keep in mind that the class system isn't really used on the Internet any more.

I should also point out that the word “classful” is also sometimes seen as “classfull”. That would be a misspelling, except, well, “classful” is not really an English word at all. That's why I always put the word “classful” in double-quotes. In fact, I must admit that I pretty much hate the word. It sounds like something an elementary school kid made up because he didn't know the opposite of the word “classless”. (The right word is *classed*, in case anyone cares.)

My wife suggests the word “classy” would sound nicer than “classful”. She's right, but IP addresses don't wear tuxedos.

Of course, nobody ever asked *my* opinion on this subject. Not even my wife.

Okay, rant over. ☺

IP "Classful" Addressing Overview and Address Classes

When the [first precursor of the Internet](#) was developed, some of the requirements of the internetwork, both present and future, were quickly realized. The Internet would start small but eventually grow. It would be shared by many organizations. Since it is necessary for all IP addresses on the internetwork to be unique, a system had to be created for dividing up

the available addresses and share them amongst those organizations. A [central authority](#) had to be established for this purpose, and a scheme developed for it to effectively allocate addresses.

The developers of IP recognized that organizations come in different sizes and would therefore need varying numbers of IP addresses on the Internet. They devised a system whereby the IP address space would be divided into *classes*, each of which contained a portion of the total addresses and were dedicated to specific uses. Some would be devoted to large networks on the Internet, while others would be for smaller organizations, and still others reserved for special purposes.

Since this was the original system, it had no name; it was just “the” IP addressing system. Today, in reference to its use of classes, it is called the “classful” addressing scheme, to differentiate it from the newer classless scheme. As I said [at the end of the introduction to this section](#), “classful” isn't really a word, but it's what everyone uses.

IP Address Classes

There are five classes in the “classful” system, which are given letters A through E. [Table 44](#) provides some general information about the classes, their intended uses and other general characteristics about them:

Table 44: IP Address Classes and Class Characteristics and Uses

IP Address Class	Fraction of Total IP Address Space	Number Of Network ID Bits	Number Of Host ID Bits	Intended Use
Class A	1/2	8	24	Unicast addressing for very large organizations with hundreds of thousands or millions of hosts to connect to the Internet.
Class B	1/4	16	16	Unicast addressing for medium-to-large organizations with many hundreds to thousands of hosts to connect to the Internet.
Class C	1/8	24	8	Unicast addressing for smaller organizations with no more than about 250 hosts to connect to the Internet.
Class D	1/16	n/a	n/a	IP multicasting.
Class E	1/16	n/a	n/a	Reserved for “experimental use”.

Looking at this table (and at [Figure 60](#)) you can see that the first three, classes A, B and C, comprise most of the total address space (7/8ths of it). These are the classes used for *unicast* IP addressing, which means for messages sent to a single network interface. (The blocks also include associated broadcast addresses for these networks.) This is what we usually consider “normal” IP addressing. You can think of classes A, B and C as the “papa bear”, “mama bear” and “baby bear” of traditional IP addressing. They allow the Internet to provide addressing for a small number of very large networks, a moderate number of

medium-sized organizations, and a large number of smaller companies. This approximately reflects the distribution of organization sizes, approximately, in the real world, though the large gulf in the maximum number of hosts allowed for each address class leads to [inflexibility and problems](#).

As you can see, the classes differ in the place where the “[dividing line](#)” is drawn between the network ID and the host ID portions of the addresses they contain. However, in each case the division is made on octet boundaries: in classful addressing, the division does not occur within an octet.

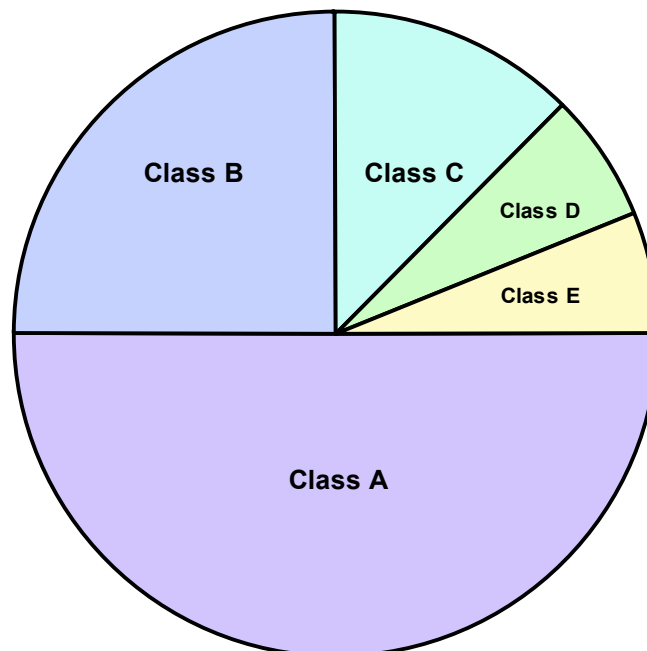

Figure 60: Division of IPv4 Address Space Into Classes

(I don't really need to explain this one, do I? ☺)

Classes D and E are special—to the point where many people don't even realize they exist. Class D is used for [IP multicasting](#), while class E was reserved for “experimental use”. I [discuss IP multicast addressing later in this section](#).

Rationale for “Classful” Addressing

While the drawbacks of the “classful” system are often discussed today (and that includes myself as well, [later in this section](#)), it's important to keep in context what the size of the Internet was when this system was developed—it was tiny, and the 32-bit address space seemed enormous by comparison to even the number of machines its creators envisioned years into the future. It's only fair to also remember the many **advantages** of the “classful” system developed over 25 years ago:

-
- ☉ **Simplicity and Clarity:** There are only a few classes to choose from and it's very simple to understand how the addresses are split up. The distinction between classes is clear and obvious. The divisions between network ID and host ID in classes A, B and C are on octet boundaries, making it easy to tell what the network ID is of any address.
 - ☉ **Reasonable Flexibility:** Three levels of “granularity” match the sizes of large, medium-sized and small organizations reasonably well. The original system provided enough capacity to handle the anticipated growth rate of the Internet at the time.
 - ☉ **Routing Ease:** As we will see shortly, the class of the address is encoded right into the address to make it easy for routers to know what part of any address is the network ID and what part is the host ID. There was no need for “adjunct” information such as a [subnet mask](#).
 - ☉ **Reserved Addresses:** Certain addresses are reserved for special purposes. This includes not just classes D and E but also [special reserved address ranges](#) for “private” addressing.

Of course it turned out that some of the decisions in the original IP addressing scheme were regrettable—but that's the benefit of hindsight. I'm sure we'd all like to have back the 268 odd million addresses that were set aside for Class E. While it may seem wasteful now to have reserved a full 1/16th of the address space for “experimental use”, remember that the current size of the Internet was never anticipated even ten years ago, never mind twenty-five. Furthermore, it's good practice to reserve some portion of any scarce resource for future use. (And besides, if we're going to play Monday morning quarterback, the real decision that should be changed in retrospect was the selection of a 32-bit address instead of a 48-bit or 64-bit one!)



Key Concept: The “classful” IP addressing scheme divides the IP address space into five classes, A through E, of differing sizes. Classes A, B and C are the most important ones, designated for conventional unicast addresses and comprising 7/8ths of the address space. Class D is reserved for IP multicasting, and Class E for experimental use.

IP "Classful" Addressing Network and Host Identification and Address Ranges

The “classful” IP addressing scheme divides the total IP address space into five classes, A through E. One of the benefits of the relatively simple “classful” scheme is that information about the classes is encoded directly into the IP address. This means we can determine in advance which address ranges belong to each class. It also means the opposite is possible: we can identify which class is associated with any address by examining just a few bits of the address.

This latter benefit was one of the main motivators for the initial creation of the “classful” system, as we saw in the previous topic.

"Classful" Addressing Class Determination Algorithm

When TCP/IP was first created computer technology was still in its infancy, compared to its current state. Routers needed to be able to quickly make decisions about how to move IP datagrams around. The IP address space was split into classes in a way that looking at only the first few bits of any IP address would tell the router where to "draw the line" between the network ID and host ID, and thus what to do with the datagram.

The number of bits the router needs to look at may be as few as one or as many as four, depending on what it finds when it starts looking. The algorithm used corresponds to the system used to divide the address space; it involves four very basic steps (see [Figure 61](#)):

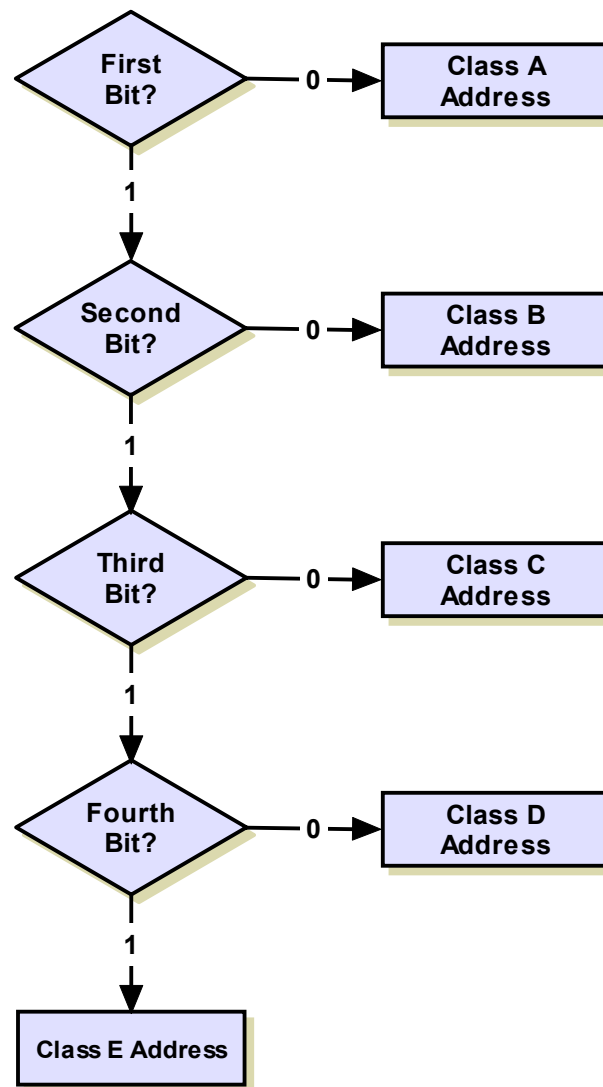

Figure 61: Class Determination Algorithm for "Classful" IP Addresses

The simplicity of the "classful" IP addressing can be seen in the very uncomplicated algorithm used to determine the class of an address.

1. If the first bit is a “0”, it's a class A address and we're done. (Half the address space has a “0” for the first bit, so this is why class A takes up half the address space.) If it's a “1”, continue to step two.
2. If the second bit is a “0”, it's a class B address and we're done. (Half of the remaining non-class-A addresses, or one quarter of the total.) If it's a “1”, continue to step three.
3. If the third bit is a “0”, it's a class C address and we're done. (Half again of what's left, or one eighth of the total.) If it's a “1”, continue to step four.
4. If the fourth bit is a “0”, it's a class D address. (Half the remainder, or one sixteenth of the address space.) If it's a “1”, it's a class E address. (The other half, one sixteenth.)

And that's pretty much it.

Determining Address Class From the First Octet Bit Pattern

As humans, of course, we generally work with addresses in dotted decimal notation and not in binary, but it's pretty easy to see the ranges that correspond to the classes. For example, consider class B. The first two bits of the first octet are “10”. The remaining bits can be any combination of ones and zeroes. This is normally represented as “10xx xxxx” (shown as two groups of four for readability.) Thus, the binary range for the first octet can be from “1000 0000” to “1011 1111”. This is 128 to 191 in decimal. So, in the “classful” scheme, any IP address whose first octet is from 128 to 191 (inclusive) is a class B address.

In [Table 45](#) I have shown the bit patterns of each of the five classes, and the way that the first octet ranges can be calculated. In the first column is the format for the first octet of the IP address, where the “x”s can be either a zero or a one. Then I show the lowest and highest value for each class in binary (the “fixed” few bits are highlighted so you can see that they do not change while the others do.) I then also show the corresponding range for the first octet in decimal.

Table 45: IP Address Class Bit Patterns, First-Octet Ranges and Address Ranges

IP Address Class	First Octet of IP Address	Lowest Value of First Octet (binary)	Highest Value of First Octet (binary)	Range of First Octet Values (decimal)	Octets in Network ID / Host ID	Theoretical IP Address Range
Class A	0xxx xxxx	0000 0001	0111 1110	1 to 126	1 / 3	1.0.0.0 to 126.255.255.255
Class B	10xx xxxx	1000 0000	1011 1111	128 to 191	2 / 2	128.0.0.0 to 191.255.255.255
Class C	110x xxxx	1100 0000	1101 1111	192 to 223	3 / 1	192.0.0.0 to 223.255.255.255
Class D	1110 xxxx	1110 0000	1110 1111	224 to 239	—	224.0.0.0 to 239.255.255.255
Class E	1111 xxxx	1111 0000	1111 1111	240 to 255	—	240.0.0.0 to 255.255.255.255



Key Concept: In the “classful” IP addressing scheme, the class of an IP address is identified by looking at the first one, two, three or four bits of the address. This can be done both by humans working with these addresses and routers making routing decisions. The use of these bit patterns means that IP addresses in different classes fall into particular address ranges that allow an address’s class to be determined by looking at the first byte of its dotted-decimal address.

Address Ranges for Address Classes

I have also shown in [Table 45](#) the *theoretical* lowest and highest IP address ranges for each of the classes. This means that the address ranges shown are just a result of taking the full span of binary numbers possible in each class. In reality, some of the values are not available for normal use. For example, even though 192.0.0.0 to 192.0.0.255 is technically in class C, it is [reserved](#) and not actually used by hosts on the Internet.

Also, there are IP addresses that can't be used because they have [special meaning](#). For example, you can't use an IP address of 255.255.255.255, as this is a reserved “all ones” broadcast address. In a similar vein, note that the range for Class A is from 1 to 126 and not 0 to 127 like you might have expected. This is because class A networks 0 and 127 are reserved; 127 is the network containing the [IP loopback address](#). These special and reserved addresses are discussed later in this section.

Now, recall that classes A, B and C differ in where the dividing line is between the network ID and the host ID: 1 for network and 3 for host for class A, 2 for each for class B, and 3 for network and 1 for host for class C. Based on this division, I have highlighted the network ID portion of the IP address ranges for each of classes A, B and C. The plain text corresponds to the range of host IDs for each allowable network ID. [Figure 62](#) shows graphically how bits are used in each of the five classes.

Phew, time for another example methinks. Let's look at class C. The lowest IP address is [192.0.0.0](#) and the highest is [223.255.255.255](#). The first three octets are the network ID, and can range from [192.0.0](#) to [223.255.255](#). For each network ID in that range, the host ID can range from 0 to 255.



Note: It is common to see resources refer to the network ID of a “classful” address as including only the “significant” bits, that is, only the ones that are not common to all networks of that class. For example, you may see a Class B network ID shown in a diagram as having 14 bits, with the “[10](#)” that starts all such networks shown separately, as if it were not part of the network ID. Remember that the network ID **does** include those bits as well; it is 8 full bits for Class A, 16 for Class B and 24 for Class C. In the case of Class D addresses, all 32 bits are part of the address, but only the lower 28 bits are part of the multicast group address; see [the topic on multicast addressing](#) for more.

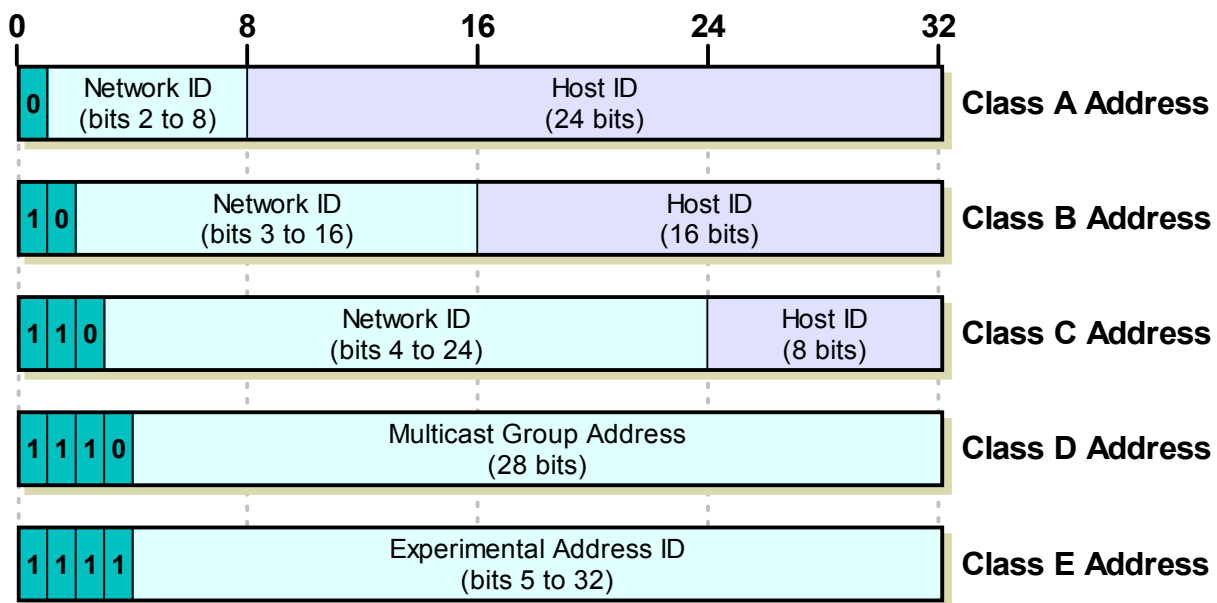

Figure 62: IP Address Class Bit Assignments and Network/Host ID Sizes

This illustration shows how the 32 bits of IP address are assigned for each of the five IP address classes. Classes A, B and C are the “normal” classes used for regular unicast addresses; each has a different dividing point between the Network ID and Host ID. Classes D and E are special and are not divided in this manner.

IP Address Class A, B and C Network and Host Capacities

In the preceding topics I introduced the concepts of [IP address classes](#) and showed how [the classes related to ranges of IP addresses](#). Of the five classes, D and E are dedicated to special purposes, so I will leave those alone for now. Classes A, B and C are the ones actually assigned for normal (unicast) addressing purposes on IP internetworks, and therefore the primary focus of our continued attention.

As we've seen, they differ in the number of bits (and octets) used for the network ID compared to the host ID. The number of different networks possible in each class is a function of the number of bits assigned to the network ID, and likewise, the number of hosts possible in each network depends on the number of bits provided for the host ID. We must also take into account the fact that one, two or three of the bits in the IP address is used to indicate the class itself, so it is effectively "excluded" from use in determining the number of networks (though again, it is still part of the network ID).

Based on this information, we can calculate the number of networks in each class, and for each class, the number of host IDs per network. [Table 46](#) shows the calculations.

Table 46: IP Address Class Network and Host Capacities

IP Address Class	Total # Of Bits For Network ID / Host ID	First Octet of IP Address	# Of Network ID Bits Used To Identify Class	Usable # Of Network ID Bits	Number of Possible Network IDs	# Of Host IDs Per Network ID
Class A	8 / 24	0xxx xxxx	1	8-1 = 7	$2^7-2 = 126$	$2^{24}-2 = 16,277,214$
Class B	16 / 16	10xx xxxx	2	16-2 = 14	$2^{14} = 16,384$	$2^{16}-2 = 65,534$
Class C	24 / 8	110x xxxx	3	24-3 = 21	$2^{21} = 2,097,152$	$2^8-2 = 254$

Let's walk through one line of this table so we can see how it works. I'll stick with class B since it's "in the middle". The basic division is into 16 bits for network ID and 16 bits for host ID. However, the first two bits of all class B addresses must be "10", so that leaves only 14 bits to uniquely identify the network ID. This gives us a total of 2^{14} or 16,384 class B network IDs. For each of these, we have 2^{16} host IDs, **less two**, for a total of 65,534.

Why less two? For each network ID, two host IDs cannot be used: the host ID with all zeroes and the ID with all ones. These are addresses with "special meanings" as described in [the topic that follows](#). You will also notice that 2 has been subtracted from the number of network IDs for class A. This is because two of the class A network IDs (0 and 127) are reserved. There are actually several other address ranges that are set aside in all three of the classes that I haven't shown here. They are listed in [the topic on reserved, private and loopback addresses](#). (The exclusion of 0 and 127 from class A is probably the best-known address range reservation which is why I am explicit with that one in the table above.)



Key Concept: In the "classful" IP addressing scheme, a Class A network contains addresses for about 16 million network interfaces; a Class B about 65,000; and a Class C, 254.

As you can see, there is quite a disparity in the number of hosts available for each network in each of these classes. What happens if an organization needs 1,000 IP addresses? They have to either use four class Cs or use one class B (and in so doing waste over 90% of the possible addresses in the class B network.) Bear in mind that there are only about 16,000 class B network IDs available worldwide and you begin to understand one of the big [problems with "classful" addressing](#).

IP Addresses With Special Meanings

Most IP addresses have the “usual” meaning I have described in the preceding topics in this section: they refer to an interface to a device on a TCP/IP network. However, some IP addresses do not refer directly to specific hardware devices in this manner. Instead, they are used to refer “indirectly” to one or more devices. To draw an analogy with language, most IP addresses refer to proper nouns, like “John” or “the red table in the corner”. However, some are used more the way we use pronouns such as “this one” or “that group over there”. I call these IP addresses with *special meanings*.

Special Network ID and Host ID Address Patterns

Special IP addresses are constructed by replacing the normal network ID or host ID (or both) in an IP address with one of two special patterns. The two patterns are:

- ☉ **All Zeroes:** When the network ID or host ID bits are replaced by a set of all zeroes, the special meaning is the equivalent of the pronoun “**this**”, referring to whatever was replaced. It can also be interpreted as “the default” or “the current”. So for example, if we replace the network ID with all zeroes but leave the host ID alone, the resulting address means “the device with the host ID given, on **this network**”. Or alternatively, “the device with the host ID specified, on **the default network** or **the current network**”.
- ☉ **All Ones:** When the network ID or host ID bits are replaced by a set of all ones, this has the special meaning of “**all**”. So replacing the host ID with all ones means the IP address refers to all hosts on the network. This is generally used as a broadcast address for sending a message to “**everyone**”.



Key Concept: When the network ID or host ID of an IP address is replaced by a pattern of all ones or all zeroes, the result is an address with a *special meaning*. Examples of such addresses include “all hosts” broadcast addresses, and addresses that refer to a specific host or a whole network.

Specific IP Address Patterns With Special Meanings

Since there are many network IDs and host IDs, there are also many of these “special” addresses. A small number are universal across the entire TCP/IP network, while others exist for each network ID or host ID. Since there are two “special patterns” that can be applied to the network ID, host ID or both, this yields six potential combinations, each of which has its own special meaning. Of these, five are used.

Table 47 describes each of these special meanings. In the table I have also provided three examples, one from each of Class A, B and C. This shows how an IP address in each of the common classes can be modified to each of the “special meaning” forms. (The first row shows the examples in their normal form, for reference.)

Table 47: IP Address Patterns With Special Meanings

Network ID	Host ID	Class A Example	Class B Example	Class C Example	Special Meaning and Description
Network ID	Host ID	77.91.215.5	154.3.99.6	227.82.157.160	Normal Meaning: Refers to a specific device.
Network ID	All Zeroes	77.0.0.0	154.3.0.0	227.82.157.0	“The Specified Network”: This notation, with a “0” at the end of the address, refers to an entire network.
All Zeroes	Host ID	0.91.215.5	0.0.99.6	0.0.0.160	“Specified Host On This Network”: This addresses a host on the current or default network when the network ID is not known, or when it doesn't need to be explicitly stated.
All Zeroes	All Zeroes	0.0.0.0			“Me”: (Alternately, “this host”, or “the current/default host”). Used by a device to refer to itself when it doesn't know its own IP address. The most common use is when a device attempts to determine its address using a host-configuration protocol like DHCP . May also be used to indicate that any address of a multihomed host may be used.
Network ID	All Ones	77.255.255.255	154.3.255.255	227.82.157.255	“All Hosts On The Specified Network”: Used for broadcasting to all hosts on the local network.
All Ones	All Ones	255.255.255.255			“All Hosts On The Network”: Specifies a global broadcast to all hosts on the directly-connected network. Note that there is no address that would imply sending to all hosts everywhere on the global Internet, since this would be very inefficient and costly.



Note: The missing combination from [Table 47](#) is that of the network ID being all ones and the host ID normal. Semantically, this would refer to “all hosts of a specific ID on all networks”, which doesn't really mean anything useful in practice, so it's not used. Note also that in theory, a special address where the network ID is all zeroes and the host ID is all ones would have the same meaning as the all-ones limited broadcast address. The latter is used instead, however, because it is more general, not requiring knowledge of where the division is between the network ID and host ID.

IP Address Limitations Due to Special Meaning Patterns

Since the all-zeroes and all-ones patterns are reserved for these special meanings, they cannot be used for regular IP addresses. This is why, when [we looked at the number of hosts per network](#) in each of the classes, we had to subtract two from the theoretical maximum: one for the all-zeroes case and one for the all-ones case.

Similarly, the network ID cannot be all zeroes either. However, this doesn't require specific exclusion because the entire block of addresses with “0” in the first octet (0.x.x.x) is one of the reserved sets of IP addresses. These reserved addresses, described in [the next topic](#), further restrict the use of certain addresses in the IP address space for “regular” uses.

IP Reserved, Loopback and Private Addresses

In [the preceding topic](#) I showed how certain IP addresses cannot be used for regular network devices because they are addresses with “special meanings”. These special addresses reduce the total number of networks that are possible in the “classful” addressing scheme, and also the total number of hosts available in each network.

In addition to these unusable numbers, there are several other sets of IP addresses set aside for various special uses, which are not available for normal address assignment. These ranges of IP addresses generally fall into the following three categories: reserved, loopback and private addresses.

Reserved Addresses

Several blocks of addresses were designated just as “reserved” with no specific indication given of what they were reserved for. They may have been set aside for future experimentation, or for internal use in managing the Internet, or for other purposes. (In general, it's a good idea to set aside some portion of any limited resource for unanticipated needs!) There are a couple of these blocks in each of the [three main classes \(A, B, and C\)](#), appearing right at the beginning and end of each class. (In a manner of speaking, all of classes D and E are also “reserved”, since they aren't used for regular addressing, though the term “reserved” is usually used to refer to unusable parts of classes A, B and C.

Loopback Addresses

Normally, when a TCP/IP application wants to send information, that information travels down the protocol layers to IP where it is [encapsulated in an IP datagram](#). That datagram then passes down to the data link layer of the device's physical network for transmission to the next hop, on the way to the IP destination.

However, one special range of addresses is set aside for *loopback* functionality. This is the range 127.0.0.0 to 127.255.255.255. IP datagrams sent by a host to a 127.x.x.x loopback address are not passed down to the data link layer for transmission. Instead, they “loop back” to the source device at the IP level. In essence, this represents a “short-circuiting” of the normal protocol stack; data is sent by a device's layer three IP implementation and then immediately received by it.

The purpose of the loopback range is testing of the TCP/IP protocol implementation on a host. Since the lower layers are short-circuited, sending to a loopback address allows the higher layers (IP and above) to be effectively tested without the chance of problems at the lower layers manifesting themselves. **127.0.0.1** is the address most commonly used for testing purposes.



Key Concept: Portions of the IP address space are set aside for reserved, private and loopback addresses.

Private/Unregistered/Non-Routable Addresses

Recall that [in the IP address overview I contrasted private and public IP addresses](#). Every IP address on a IP network must be unique, and in the case of a public IP network, addresses are allocated using a [central authority](#) to ensure that there is no overlap. In contrast, if you set up a private network you can use whatever addresses you want; it's your show and nobody else has a say on what you do.

So, if this is the case, why not just pick any random block of class A, B or C addresses for your private network and use that? Well, you could; since you aren't connected to the Internet you could use, say, the class A network 18.x.x.x that is reserved on the Internet to the [Massachusetts Institute of Technology \(MIT\)](#). Since you aren't connected to MIT, what does it matter?

In the past, there were people who **did** choose to do this—and ended up regretting that decision. As the Internet grew in importance, they would later decide that such private networks needed to connect to the public Internet after all. If that happened and you had used 18.x.x.x addresses, you'd find yourself having to renumber all your devices to avoid getting a big bunch of geeks really angry. (There were in fact cases where companies that had used IP address space belonging to other companies accidentally connected those machines to the Internet, causing a small amount of ruckus in the process.)

From a more mundane standpoint, having internal devices with MIT's IP addresses is a source of confusion. It's just not a great idea to have lots of different companies "borrowing" IP addresses for their private networks.

As an alternative, RFC 1918 (superseding RFC 1597) defines a set of special address blocks that are set aside just for private addresses. These addresses simply don't exist to the public Internet. Anyone can use them with no need to contact any authority for permission. At the same time, they cannot connect to the global Internet, because routers are not programmed with entries to forward traffic with these address ranges outside of local organizations. RFC 1918 was in fact published to encourage the use of these private blocks, in order to cut down on the number of devices on the public Internet that didn't really need to be publicly-accessible. This was in response to the need to [conserve the public address space](#).

In order to connect a network using private addressing to the public Internet, it is necessary to employ additional hardware and/or software. A gateway machine can be used as an interface between the public and private networks. Technologies such as [IP Network Address Translation \(NAT\)](#) are often used in conjunction with private IP addresses to allow these hosts to communicate on the public IP network.



Key Concept: Private address blocks were created to allow private IP internets to be created using addresses that were guaranteed not to conflict with public IP addresses. They are commonly used in internetworks not connected to the global Internet; devices using them can also access the global Internet by using [NAT](#).

Reserved, Loopback and Private Addressing Blocks

[Table 48](#) shows all of the special blocks set aside from the normal IP address space in numerical order, with a brief explanation of how each is used:

Table 48: Reserved, Loopback and Private IP Addresses (Page 1 of 2)

Range Start Address	Range End Address	"Classful" Address Equivalent	Classless Address Equivalent	Description
0.0.0.0	0.255.255.255	Class A network 0.x.x.x	0/8	Reserved.
10.0.0.0	10.255.255.255	Class A network 10.x.x.x	10/8	Class A private address block.
127.0.0.0	127.255.255.255	Class A network 127.x.x.x	127/8	Loopback address block.
128.0.0.0	128.0.255.255	Class B network 128.0.x.x	128.0/16	Reserved.

Table 48: Reserved, Loopback and Private IP Addresses (*Page 2 of 2*)

Range Start Address	Range End Address	“Classful” Address Equivalent	Classless Address Equivalent	Description
169.254.0.0	169.254.255.255	Class B network 169.254.x.x	169.254/16	Class B private address block reserved for automatic private address allocation. See the section on DHCP for details.
172.16.0.0	172.31.255.255	16 contiguous Class B networks from 172.16.x.x through 172.31.x.x	172.16/12	Class B private address blocks.
191.255.0.0	191.255.255.255	Class B network 191.255.x.x	191.255/16	Reserved.
192.0.0.0	192.0.0.255	Class C network 192.0.0.x	192.0.0/24	Reserved.
192.168.0.0	192.168.255.255	256 contiguous Class C networks from 192.168.0.x through 192.168.255.x	192.168/16	Class C private address blocks.
223.255.255.0	223.255.255.255	Class C network 223.255.255.x	223.255.255/24	Reserved.

I have shown both the “classful” and [classless notation](#) representing each of these blocks. This is both because the Internet now uses [classless addressing](#), and because some of the private blocks don't correspond to single class A, B or C networks. Note especially the private address block from 192.168.0.0 to 192.168.255.255. This is the **size** of a class B network, but it isn't class B in the “classful” scheme, because the first octet of “192” puts it in the class C part of the address space. It is in fact 256 contiguous class C networks.

You may also notice the special class B (/16) block 169.254.x.x. This is reserved for *Automatic Private IP Addressing (APIPA)*. Systems that are configured to use this feature will automatically assign systems addresses from this block to enable them to communicate even if no server can be found for “proper” IP address assignment using DHCP. This is described in [a special topic in the section describing DHCP](#).

IP Multicast Addressing

The vast majority of traffic on IP internetworks is of the *unicast* variety: one source device sending to one destination device. IP also supports *multicasting*, where a source device can send to a group of devices. Multicasting is not used a great deal on the Internet as a whole at the present time, mainly due to lack of widespread hardware support, so most of our focus in looking at IP is on unicast. Multicast is useful in certain circumstances, however,

especially as a more efficient alternative to broadcasting. I include [one summary topic on multicasting](#) for your perusal, and also want to briefly discuss here IP addressing issues related to multicasting.

The “classful” IP addressing scheme sets aside a full one-sixteenth of the address space for multicast addresses: Class D. Multicast addresses are [identified by the pattern “1110” in the first four bits](#), which corresponds to a first octet of 224 to 239. So, the full range of multicast addresses is from 224.0.0.0 to 239.255.255.255. Since multicast addresses represent a group of IP devices (sometimes called a *host group*) they can only be used as the destination of a datagram; never the source.

Multicast Address Types and Ranges

The 28 bits after the leading “1110” in the IP address define the *multicast group address*. The size of the Class D multicast address space is therefore 2^{28} or 268,435,456 multicast groups. There is no substructure that defines the use of these 28 bits; there is no specific concept of a network ID and host ID as in classes A, B and C. However, certain portions of the address space are set aside for specific uses. [Table 49](#) and [Figure 63](#) show the general allocation of the Class D address space.

Table 49: IP Multicast Address Ranges and Uses

Range Start Address	Range End Address	Description
224.0.0.0	224.0.0.255	Reserved for special “well-known” multicast addresses.
224.0.1.0	238.255.255.255	Globally-scoped (Internet-wide) multicast addresses.
239.0.0.0	239.255.255.255	Administratively-scoped (local) multicast addresses.



Note: As with the other IP address classes, the entire 32 bits of the address is always used; we are just only interested in the least-significant 28 bits because the upper four bits never change.

The bulk of the address space is in the middle multicast range, which are “normal” multicast addresses. They are analogous to the Class A, B and C unicast addresses and can be assigned to various groups.

The last address range is for *administratively-scoped* multicast groups. This is a fancy term for multicast groups used within a private organization; this block, representing 1/16th of the total multicast address space, is comparable to the [private addresses we saw in the preceding topic](#). This block is also subdivided further into site-local multicast addresses, organization-local addresses and so forth.

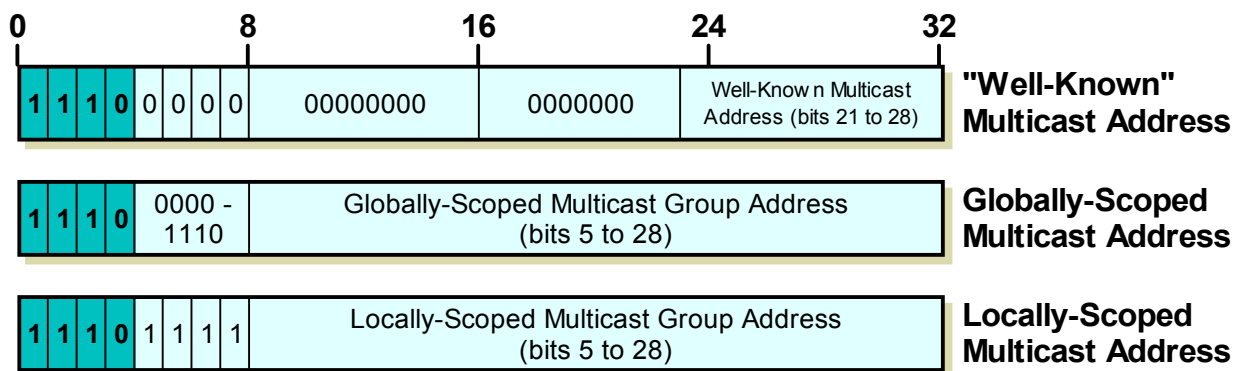

Figure 63: IP Multicast Address Ranges and Uses

All multicast addresses begin with “1110” as shown. The “well-known” group has zeroes for the first 20 bits of the multicast group address, with 8 bits available to define 255 special multicast addresses. Multicast addresses starting with “1110 1111” are locally-scoped; all other addresses are globally-scoped (this includes addresses starting with “1110 0000” **other than** the 255 “well-known” addresses.)



Related Information: The concept of multicast address scope was more completely defined in IPv6, and I discuss it in more detail in the [in the discussion of IPv6 multicast addresses](#).

Well-Known Multicast Addresses

The first block of 256 addresses is used to define special, **well-known** multicast address blocks. These do not represent arbitrary groups of devices and cannot be assigned in that manner. Instead, they have special meaning that allows a source to send a message to a predefined group. [Table 50](#) shows some of the “well-known” multicast addresses:

Table 50: Well-Known IP Multicast Addresses (Page 1 of 2)

Range Start Address	Description
224.0.0.0	Reserved; not used
224.0.0.1	All devices on the subnet
224.0.0.2	All routers on the subnet
224.0.0.3	Reserved
224.0.0.4	All routers using DVMRP
224.0.0.5	All routers using OSPF
224.0.0.6	Designated routers using OSPF
224.0.0.9	Designated routers using RIP-2

Table 50: Well-Known IP Multicast Addresses (Page 2 of 2)

Range Start Address	Description
224.0.0.11	Mobile agents (for Mobile IP)
224.0.0.12	DHCP Server / Relay Agent



Note: There are some other predefined groups that also refer to routers using particular [routing protocols](#); I didn't bother listing them all as the table would get quite large.

Delivery of IP multicast traffic is more complex than unicast traffic due to the existence of multiple recipients. Instead of the normal resolution method through the ARP protocol used for unicast datagrams, [a special mapping is performed between the IP multicast group and a hardware multicast group](#).

Problems With "Classful" IP Addressing

The “classful” addressing system was the first major attempt to define a method for universal addressing of a large IP internetwork. The system had some advantages, as I mentioned in [the overview of the “classful” scheme](#), and given that it was developed decades ago for a network that was limited in size, it did the job remarkably well for a long time.

Nobody ever expected the Internet to mushroom to anything close to its current size. As it grew, problems become apparent with the “classful” IP addressing mechanism—slowly at first, but then more rapidly as growth became more rapid. I've hinted at some of these problems in my explanation of how this type of addressing works, but to help frame the discussion of newer addressing types, I think it is useful to look at this in more detail.

Summary of “Classful” Addressing Issues

There are three main problems with “classful” addressing, which are somewhat related to each other (making them a bit harder to explain). Let's start with a quick summary of what these issues are:

1. **Lack of Internal Address Flexibility:** Big organizations are assigned large, “monolithic” blocks of addresses that don't match well the structure of their underlying internal networks.
2. **Inefficient Use of Address Space:** The existence of only three block sizes (classes A, B and C) leads to waste of limited IP address space.
3. **Proliferation of Router Table Entries:** As the Internet grows, more and more entries are required for routers to handle the routing of IP datagrams, which causes performance problems for routers. Attempting to reduce inefficient address space allocation leads to even more router table entries.

Addressing Inflexibility

Issue #1 results primarily from the fact that in the “classful” system, big companies get assigned a rather large (Class B) or truly enormous (Class A) block of addresses, all of which is considered by the Internet routers a single “network” with one “network ID”. Now, imagine that you are running a medium-to-large-sized company with 5,000 computers, and you are assigned a Class B address for your network. Do you really have 5,000 computers all hooked into a single network? I sure as heck hope you don't! Yet you would be forced to try to fit all of these into a single IP “network” in the original “classful” method. There was no way to create an internal hierarchy of addresses.

The Key Problem with Classes: Low Granularity

Issues #2 and #3 are more closely related to each other than issue #1 and are both the result of the fact that the “granularity” in the “classful” system is simply too low to be practical in a large internet. By this I mean that there are too few choices in the sizes of networks available. Three sizes seems fine in principle, but the gaps between the sizes are enormous, and the sizes don't match up all that well with the distribution of organizations in the real world. Consider the difference in size between Class C and Class B networks—a jump from 254 hosts all the way up to over 65,000! There are many, many companies that need more than 254 IP address but a lot fewer than 65,000. And what about Class A? How many companies need 16 *million* IP addresses, even the truly large ones? Probably none, if you think about it, yet that's half the IP address space right there.

Considering our company with 5,000 computers again—what class network should they use? As [Figure 64](#) shows, there is no good match for this company's needs in the “classful” scheme at all. In the past, they would likely have been assigned a Class B network. However, giving a Class B to a company with “only” 5,000 computers means over 90% of the IP addresses are **wasted**. When the Internet was young this wasn't a big deal, but as it grew these inefficiencies quickly started to become significant.

The alternative to wasting all these IP addresses would be to give the company instead of one Class B, a bunch of Class C addresses. However as you can see, they would need **20** of them. This is more efficient in use of address space, but leads to Issue #3: every router on the Internet replaces the single Class B router table entry with **20** Class C router entries. Now multiply this by a few thousand “medium-sized” companies and you can see that this method would add dramatically to the size of router tables. Router tables have already been growing quickly as the Internet has expanded. The larger these tables, the more time it takes for routers to make routing decisions.

Tactics for Dealing with “Classful” Addressing Difficulties

These issues were addressed through three enhancements or improvements that I discuss in other sections. The first, which primarily addresses Issue #1, was the development of [subnetting](#). The second was the move to [classless addressing and routing](#), which replaces the “classful” system with a new method with higher granularity. This tackles Issues #2 and #3 by letting addresses be assigned based on real organizational needs without requiring

Hosts in Class C
Network (254)



Hosts Needed
By Organization
(5,000)



Hosts in Class B
Network (65,534)

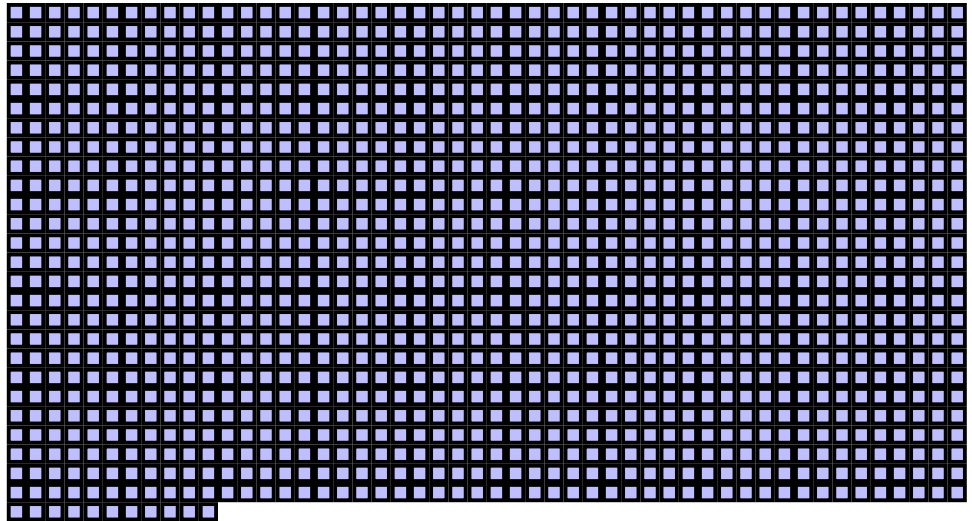

Figure 64: The Main Problem With “Classful” Addressing

In this scale diagram, each square represents 50 available addresses. Since a Class C address has only 254 addresses, and a Class B contains 65,534 addresses, an organization with 5,000 hosts is “caught in the middle”. It can only choose to either waste 90% of a Class B address or use 20 different Class C networks.

numerous routing table entries for each organization. The third improvement is the new [IP version 6 protocol](#), which finally does away with the cramped 32-bit IP address space in favor of a [gargantuan 128-bit one](#).

Other support technologies have also helped extend the life of IP version 4. I discussed one important one in the previous topic—the use of [private addressing](#) in conjunction with [IP Network Address Translation \(NAT\)](#) to allow multiple devices to share public addresses. This alone has added years to the life of the IPv4 addressing system.



IP Subnet Addressing ("Subnetting") Concepts

The original “classful” IP addressing scheme conceptually divides a large internetwork into a simple two-level hierarchy: many *networks* of different sizes, each of which contains a number of *hosts*. The system works well for smaller organizations that may connect all their machines in a single network. However, it lacks flexibility for large organizations that often have many subnetworks, or *subnets*. To better meet the administrative and technical requirements of larger organizations, the “classful” IP addressing system was enhanced through a technique known as *subnet addressing*, or more simply, *subnetting*.

In this section I describe the concepts and general techniques associated with IP subnet addressing. I begin with an overview of subnetting, including a discussion of the motivation for the system and its advantages. I discuss how the traditional “two-level” method for dividing IP addresses becomes “three-level” for subnetting. I talk about subnet masks and how they are used in calculations for addressing and routing. I discuss the default subnet masks used to represent the “classful” Class A, B and C networks in a subnetting environment, and then how custom subnet masks are used for classes A, B and C. I then discuss subnet identifiers and general concepts behind determining subnet and host addresses in a subnet environment. I provide summary tables for subnetting Class A, B and C networks. I conclude with a brief discussion of Variable Length Subnet Masking (VLSM), an enhancement of “conventional” subnetting that improves its flexibility further.



Note: I provide a great deal of coverage of subnetting, because understanding it is an important part of learning about how IP addresses work, and hence, how TCP/IP functions. However, I need to emphasize something that far too few references mention: the technique is today considered mostly *historical*. The reason is that subnetting is still based on “classful” addressing, which has been replaced by [classless addressing](#) on the Internet. The concept of a subnet and subnet mask has certainly not disappeared altogether, but the idea of being assigned a Class A, B or C Internet address block and then explicitly subnetting it is no longer relevant.



Related Information: This is the first of two sections dedicated to IP address subnetting. [The second section follows this one and describes the step-by-step process for subnetting using examples.](#) If you find that after reading this concepts section that you don't quite understand subnetting, try reading the example-based section and you may find that it helps make it all “click”. On the other hand, if you are already somewhat familiar with subnetting, you may find that you can skip this concepts section and just go through the step-by-step examples. You will find much more in that section in the way of “gory details” of subnet mask, subnet address and host address calculations. Putting the practical details there allows this section to concentrate on concepts without getting too bogged down in numbers.



Background Information: Understanding subnetting requires a certain familiarity with binary numbers and how they are manipulated. This includes the concept of using boolean operators such as *AND* to “mask” binary digits. If reading that last sentence made you go “huh?” I ***strongly recommend*** reviewing [the background section on computing mathematics](#) before you proceed.

IP Subnet Addressing Overview, Motivation, and Advantages

IP addressing was originally designed around the assumption of a strict [two-level hierarchy for internetworks](#). The first level was the *network*, and the second level the *host*. Each organization was usually represented by a single network identifier that indicated a [Class A, B or C block](#) dedicated to them. Within that network they had to put all of the devices they wanted to connect to the public IP network.

The Motivation for Subnet Addressing

It did not take long after the “classful” scheme was developed for serious inadequacies in it to be noticed, especially by larger organizations. The reason is that while dividing a large internetwork into networks that contain hosts is conceptually simple, it doesn't always match well the structure of each of the networks that comprises the internet. A big company with thousands of computers doesn't structure them as one big whomping physical network. Trying to assign and administer IP addresses to an organization's entire network without any form of internal logical structure is very difficult.

Unfortunately, under the original “classful” addressing scheme, there was no good solution to this problem. The most commonly-chosen alternative at the time was to trade a single large block of addresses such as a Class B for a bunch of Class Cs. However, this caused additional problems:

- ☉ It contributed to the explosion in size of IP routing tables.
- ☉ Every time more address space was needed, the administrator would have to apply for a new block of addresses.
- ☉ Any changes to the internal structure of a company's network would potentially affect devices and sites outside the organization.
- ☉ Keeping track of all those different Class C networks would be a bit of a headache in its own right.



Related Information: I fully explain [the problems with “classful” addressing](#) within [the section on “classful” addressing](#).

The Development of Subnet Addressing

In order to address this problem adequately, an enhancement was required to the “classful” addressing scheme. This change was outlined in RFC 950, which defined a new addressing procedure called *subnet addressing* or *subnetting*. (This RFC was published way back in 1985, which surprises some people!)

The basic idea behind subnet addressing is to add an additional hierarchical level in the way IP addresses are interpreted. The concept of a network remains unchanged, but instead of having just “hosts” within a network, a new two-level hierarchy is created: *subnets* and hosts. Each subnet is a subnetwork, and functions much the way a full network does in conventional classful addressing. A three-level hierarchy is thus created: networks, which contain subnets, each of which then has a number of hosts.

Thus, instead of an organization having to lump all of its hosts under that network in an unstructured manner, it can organize hosts into subnets that reflect the way internal networks are structured. These subnets fit within the network identifier assigned to the organization, just as all the “unorganized” hosts used to.

Advantages of Subnet Addressing

In essence, subnet addressing allows each organization to have its own “internet within the Internet”. Just as the real Internet looks only at networks and hosts, a two-level hierarchy, each organization can now also have subnets and hosts within their network. This change provides numerous advantages over the old system:

- ☉ **Better Match to Physical Network Structure:** Hosts can be grouped into subnets that reflect the way they are actually structured in the organization’s physical network.
- ☉ **Flexibility:** The number of subnets and number of hosts per subnet can be customized for each organization. Each can decide on its own subnet structure and change it as required.
- ☉ **Invisibility To Public Internet:** Subnetting was implemented so that the internal division of a network into subnets is visible only within the organization; to the rest of the Internet the organization is still just one big, flat, “network”. This also means that any changes made to the internal structure are not visible outside the organization.
- ☉ **No Need To Request New IP Addresses:** Organizations don’t have to constantly requisition more IP addresses, as they would in the workaround of using multiple small Class C blocks.
- ☉ **No Routing Table Entry Proliferation:** Since the subnet structure exists only within the organization, routers outside that organization know nothing about it. The organization still maintains a single (or perhaps a few) routing table entries for all of its devices. Only routers inside the organization need to worry about routing between subnets.

The Impact of Subnetting on Addressing and Routing

The change to subnetting affects both addressing and routing in IP networks. Addressing changes of course, because instead of having just a network ID and host ID, we now also have a *subnet ID* to be concerned with. The size of the subnet ID can vary for each network, so an additional piece of information is needed to supplement the IP address to indicate what part of the address is the subnet ID and what part is the host ID. This is a 32-bit number commonly called a *subnet mask*. The mask is used both for calculating subnet and host addresses, and by routers for determining how to move IP datagrams around a subnetted network.

Routing changes because of the additional level of hierarchy. In regular “classful” addressing, when a router receives an IP datagram, it only needs to decide if the destination is on the same network or a different network. Under subnetting, it must also look at the subnet ID of the destination and make one of three choices: same subnet, different subnet on the same network, or different network. Again, this is done using the subnet mask. Changes are also required to routing protocols, such as the [Routing Information Protocol \(RIP\)](#), to deal with subnets and subnet masks.



Key Concept: Subnet addressing adds an additional hierarchical level to how IP addresses are interpreted, by dividing an organization’s IP network into *subnets*.

This allows each organization to structure its address space to match its internal physical networks, rather than being forced to treat them a flat block. This solves a number of problems with the original “classful” addressing scheme, but requires changes to how addressing and routing work, as well as modifications to several TCP/IP protocols.

It’s funny, but the main drawbacks to subnetting, compared with the older addressing scheme, have more to do with understanding how subnetting works than the technology itself! More effort is required to deal with addressing and routing in a subnet environment, and administrators must learn how to subdivide their network into subnets and properly assign addresses. This can be a bit confusing to someone who is new to subnetting. However, the technology today is quite well-established so even this is not much of a problem. For the newcomer, having a handy reference guide like this one certainly helps. 😊

IP Subnetting: "Three-Level" Hierarchical IP Subnet Addressing

The simplest division of IP addresses is into a structure containing two elements: the *network ID* and the *host ID*. [In explaining this concept](#), I drew an analogy to the way North American phone numbers are ten digits long, but are broken down into a three-number area code and a seven-digit local number.

[As I mentioned in the preceding topic](#), subnetting adds an additional level to the hierarchy of structures used in IP addressing. To support this, IP addresses must be broken into three elements instead of two. This is done by leaving the network ID alone and dividing the host

ID into a *subnet ID* and host ID. These subnet ID bits are used to identify each subnet within the network. Hosts are assigned to the subnets in whatever manner makes the most sense for that network.

Interestingly, the analogy to telephone numbers that we used before still holds in the world of subnetting, and shows how subnetting changes the way IP addresses are interpreted. A number like (401) 555-7777 has an area code (“401”) and a local number (“555-7777”) as I said before. The local number, however, can itself be broken down into two parts: the exchange (“555”) and the local extension (“7777”). This means phone numbers really are comprised of three hierarchical components just as IP addresses are in subnetting.

Of course, the number of bits in an IP address is fixed at 32. This means that in splitting the host ID into subnet ID and host ID, we reduce the size of the host ID portion of the address. In essence, we are “stealing” bits from the host ID to use for the subnet ID. Class A networks have 24 bits to split between the subnet ID and host ID: class B networks have 16, and class C networks only 8.



Key Concept: A “classful” network is subnetted by dividing its host ID portion, leaving some of the bits for the host ID while allocating others to a new *subnet ID*. These bits are then used to identify individual subnets within the network, into which hosts are assigned.

Now, remember when [we looked at the sizes of each of the main classes](#), we saw that for each class, the number of networks and the number of hosts per network are a function of how many bits we use for each. The same applies to our splitting of the host ID. Since we are dealing with binary numbers, the number of subnets is two to the power of the size of the subnet ID field. Similarly, the number of hosts per subnet is two to the power of the size of the host ID field (less two for excluded special cases).

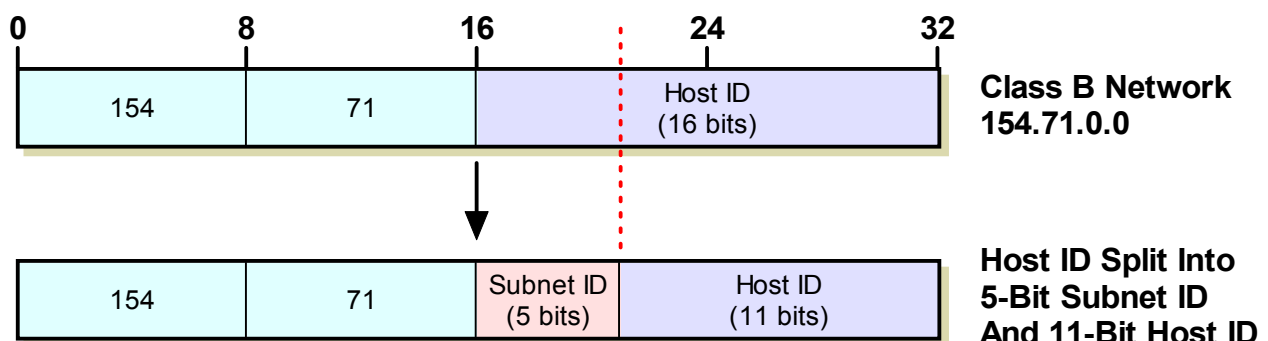

Figure 65: Subnetting A Class B Network

We begin with the Class B network 154.71.0.0, which has 16 bits in its host ID block as shown at top. We then subnet this network by dividing the host ID into a subnet ID and host ID. In this case, 5 bits have been allocated to the subnet ID, leaving 11 for the host ID.

Let's take a brief example to see how this works. Imagine that we start with Class B network 154.71.0.0. 16 bits are for the network ID (154.71) and 16 for the host ID. In regular “classful” addressing there are no subnets (well, one “subnet” that is the whole network, but never mind about that) and 65,534 hosts total. To subnet this network, we can decide to split those 16 bits however we feel best suits the needs of our network: 1 bit for the subnet ID and 15 for the host ID, or 2 and 14, 3 and 13, and so on. Most any combination will work, as long as the total is 16, such as 5 and 11, which I illustrate in [Figure 65](#). The more bits we “steal” from the host ID for the subnet ID, the more subnets we can have—but the fewer hosts we can have for each subnet.

Deciding how to make this choice is one of the most important design considerations in setting up a subnetted IP network. The number of subnets is generally determined based on the number of physical subnetworks in the overall organizational network. The number of hosts per subnetwork must not exceed the maximum allowed for the particular subnetting choice we make. Choosing how to divide the original host ID bits into subnet ID bits and host ID bits is sometimes called *custom subnetting* and is [described in more detail later in this section](#).

IP Subnet Masks, Notation and Subnet Calculations

[Subnetting](#) divides an organization's network into a two-level structure of subnets and hosts. This division is entirely internal and hidden from all other organizations on the Internet. One of the many advantages of this is that each organization gets to make their own choice about how to divide the “classful” host ID into subnet ID and host ID.

In a non-subnetted “classful” environment, [routers use the first octet of the IP address](#) to determine what the class is of the address, and from this they know which bits are the network ID and which are the host ID. When we use subnetting, these routers also need to know how that host ID is divided into subnet ID and host ID. However, this division can be arbitrary for each network. Furthermore, there is no way to tell how many bits belong to each simply by looking at the IP address.

In a subnetting environment, the additional information about which bits are for the subnet ID and which for the host ID must be communicated to devices that interpret IP addresses. This information is given in the form of a 32-bit binary number called a *subnet mask*. The term “mask” comes from the binary mathematics concept called *bit masking*. This is a technique where a special pattern of ones and zeroes can be used in combination with boolean functions such as *AND* and *OR* to select or clear certain bits in a number. [I explain bit masking in the background section on binary numbers and mathematics](#).

Function of the Subnet Mask

There's something about subnet masks that seems to set people's hair on end, especially if they aren't that familiar with binary numbers. However, the idea behind them is quite straight-forward. The mask is a 32-bit number, just as the IP address is a 32-bit number. Each of the 32 bits in the subnet mask corresponds to the bit in the IP address in the same

location in the number. The bits of the mask in any given subnetted network are chosen so that the bits used for either the network ID or subnet ID are ones, while the bits used for the host ID are zeroes.



Key Concept: The *subnet mask* is a 32-bit binary number that accompanies an IP address. It is created so that it has a one bit for each corresponding bit of the IP address that is part of its network ID or subnet ID, and a zero for each bit of the IP address's host ID. The mask thus tells TCP/IP devices which bits in that IP address belong to the network ID and subnet ID, and which are part of the host ID.

Why bother doing this with a 32-bit binary number? The answer is the magic of [boolean logic](#). We use the subnet mask by applying the boolean *AND* function between it and the IP address. For each of the 32 “bit pairs” in the IP address and subnet mask we employ the *AND* function, the output of which is 1 only if both bits are 1. What this means in practical terms is the following, for each of the 32 bits:

- ☉ **Subnet Bit Is A One:** In this case, we are *ANDing* either a 0 or 1 in the IP address with a 1. If the IP address bit is a 0, the result of the *AND* will be 0, and if it is a 1, the *AND* will be 1. In other words, *where the subnet bit is a 1, the IP address is preserved unchanged.*
- ☉ **Subnet Bit Is A Zero:** Here, we are *ANDing* with a 0, so the result is always 0 regardless of what the IP address is. Thus, *when the subnet bit is a 0, the IP address bit is always cleared to 0.*

So, when we use the subnet mask on an IP address, the bits in the network ID and subnet ID are left intact, while the host ID bits are removed. Like a mask that blocks part of your face but lets other parts show, the subnet mask blocks some of the address bits (the host bits) and leaves others alone (the network and subnet bits). A router that performs this function is left with the address of the subnet. Since it knows from the class of the network what part is the network ID, it also knows what subnet the address is on.



Key Concept: To use a subnet mask, a device performs a boolean *AND* operation between each bit of the subnet mask and each corresponding bit of an IP address. The resulting 32-bit number contains only the network ID and subnet ID of the address, with the host ID cleared to zero.

Subnet Mask Notation

Like IP addresses, subnet masks are always used as a 32-bit binary number by computers. And like IP addresses, using them as 32-bit binary numbers is difficult for humans. Therefore, they are usually converted to dotted decimal notation for convenience, just like IP addresses are.

Let's take a quick example to show what this is all about. Suppose we have the Class B network 154.71.0.0. We decide to subnet this using 5 bits for the subnet ID and 11 bits for the host ID. In this case, the subnet mask will have 16 ones for the network portion (since this is Class B) followed by 5 ones for the subnet ID, and 11 zeroes for the host ID. That's "11111111 11111111 11111000 00000000" in binary, with the bits corresponding to the subnet ID highlighted. Converting to dotted decimal, the subnet mask would be 255.255.248.0. [Figure 66](#) illustrates this process.

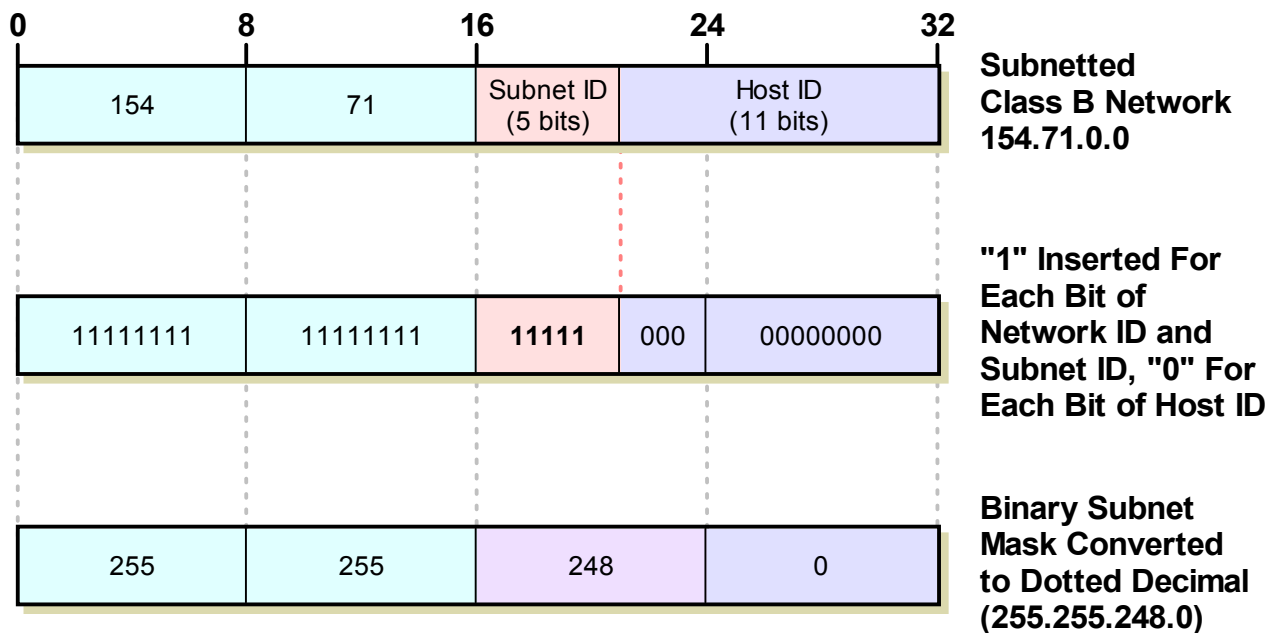

Figure 66: Determining the Subnet Mask of a Subnetted Network

The class B network from [Figure 65](#) has been shown at top, with 5 bits assigned to the subnet ID and 11 bits left for the host ID. To create the subnet mask, we fill in a 32-bit number with "1" for each network ID and subnet ID bit, and "0" for each host ID bit. We can then convert this to dotted decimal.

Applying the Subnet Mask: An Example

Now, let's see how the subnet mask might be used. Suppose we have a host on this network with an IP of 154.71.150.42. A router needs to figure out which subnet this address is on. This is done by performing the masking operation shown in [Table 51](#) and [Figure 67](#).

Table 51: Determining the Subnet ID of an IP Address Through Subnet Masking

Component	Octet 1	Octet 2	Octet 3	Octet 4
IP Address	10011010 (154)	01000111 (71)	10010110 (150)	00101010 (42)
Subnet Mask	11111111 (255)	11111111 (255)	11111000 (248)	00000000 (0)
Result of AND Masking	10011010 (154)	01000111 (71)	10010000 (144)	00000000 (0)

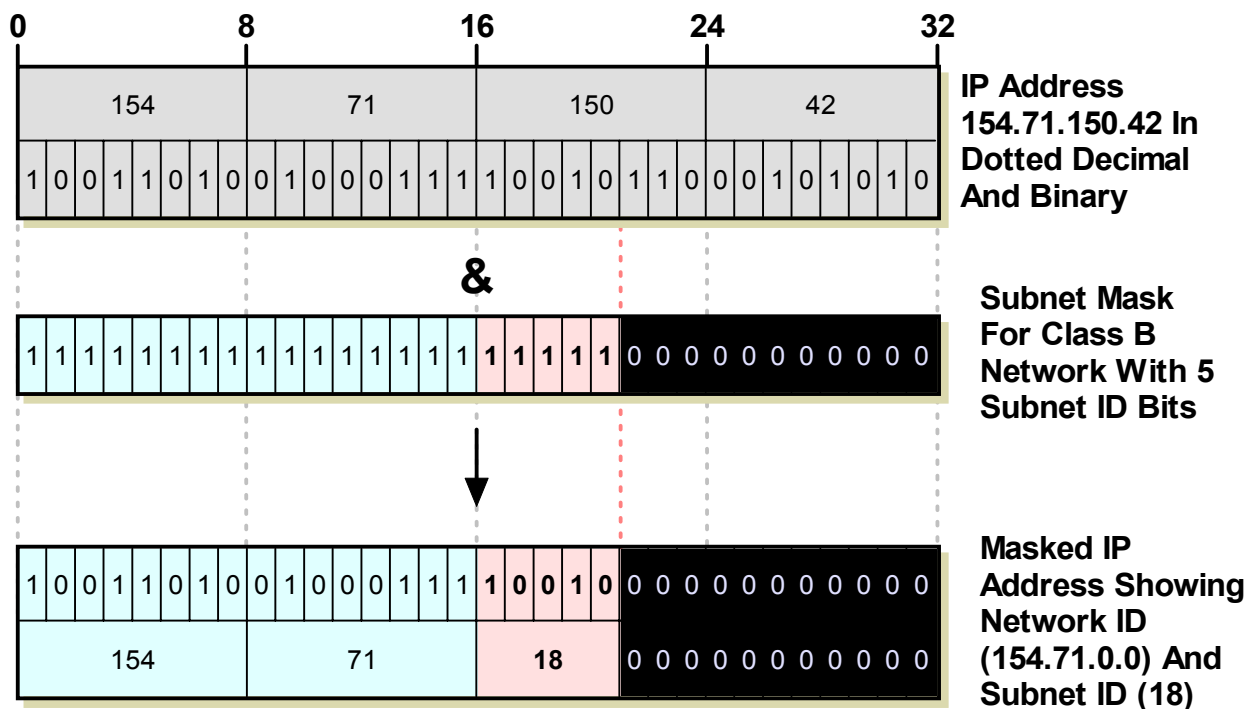

Figure 67: Determining the Subnet ID of an IP Address Through Subnet Masking

Subnet masking involves performing a boolean *AND* between each corresponding bit in the subnet mask and the IP address. The subnet mask can be likened to a [physical mask](#); each 1 in it lets the corresponding bit of the IP address “show through”, while each 0 blocks the corresponding IP address bit. In this way the host ID bits of the address are stripped so the device can determine the subnet to which the address belongs.

This result, 154.71.144.0, is the IP address of the subnet to which 154.71.150.42 belongs. There is no need to explicitly differentiate the network ID bits from the subnet ID bits, because we are still using “classful” addresses. Any router can see that since the first two bits of the address are “10”, this is a Class B address. So the network ID is 16 bits, and this means the subnet ID must be bits 17 to 21, counting from the left. Here, the subnet is the portion highlighted above: “10010”, or subnet #18. ([I'll explain this better in the section on custom subnetting.](#))



Key Concept: The subnet mask is often expressed in dotted decimal notation for convenience, but is used by computers as a binary number, and usually must be expressed in binary to understand how the mask works and the number of subnet ID bits it represents.

Rationale for Subnet Mask Notation

So, in practical terms, the subnet mask actually conveys only a single piece of information: where the line is drawn between the subnet ID and host ID. You might wonder, why bother with a big 32-bit binary number in that case, instead of just specifying the bit number where

the division occurs? Instead of carrying the subnet mask of 255.255.248.0 around, why not just say “divide the IP address after bit #21”? Even if devices want to perform a masking operation, could they not just create the mask as needed?

That's a very good question. There are two historical reasons: efficiency considerations and support for non-contiguous masks.

Efficiency

The subnet mask expression is efficient, in that it allows routers to perform a quick masking operation to determine the subnet address. This improves performance; remember that computers were much slower when this system was developed. Today this is not really that much of an issue.

Support For Non-Contiguous Masks

RFC 950 actually specified that when splitting the bits in the host ID for subnet ID and host ID, it was possible to split it in more than one place! In the example above, we could, instead of splitting the 16 bits into 5 bits for subnet ID and 11 for host ID, have done it as 2 bits for the subnet ID, then 4 bits for the host ID, then 3 more bits for the subnet ID and finally 7 more bits for host ID. This would be represented by the subnet mask pattern “11000011 10000000” for those sixteen bits (following the sixteen ones for the network ID).

Why do this instead of just dividing as 5 bits for subnet ID followed by 11 bits for host ID as we did before? I have no idea. ☺ In fact, most other people had no idea either. Trying to subnet this way makes assigning addresses **extremely** confusing. For this reason, while it was technically legal, the use of non-contiguous subnet masking was not recommended, and not done in practice.

Given that non-contiguous masks are not used, and today's computers are more efficient, the alternative method of expressing masks with just a single number is now often used. Instead of specifying “IP address of 154.71.150.42 with subnet mask of 255.255.248.0”, we can just say “154.71.150.42/21”. This is sometimes called *slash notation* or *CIDR notation*. It is more commonly used in [variable-length masking \(VLSM\)](#) environments, and as the second name implies, is also [the standard for specifying classless addresses under the CIDR addressing scheme](#). However, it is also sometimes seen in regular subnetting discussions.



Note: Since these weird masks were never really used, some resources say that the subnet mask always had to be contiguous, but this is not true—originally, it was legal but “advised against”. Later this practice became so out-of-favor that many hardware devices would not support it. Today, now that classless addressing and CIDR are standard, it is simply illegal.

If you've never subnetted before, this topic may have left you with your head spinning, despite our looking at an example. Don't worry. It will all become more clear as you become more familiar with subnetting by following the rest of this section. Remember also that [I have included a whole section that shows how to subnet step by step](#), including determining the subnet mask.

IP Default Subnet Masks For Address Classes A, B and C

[Subnetting](#) is the process of dividing a Class A, B or C network into subnets, as we've seen in the preceding topics. In order to better understand how this “division of the whole” is accomplished, it's worth starting with a look at how the “whole” class A, B and C networks are represented in a subnetted environment. This is also of value because there are situations where you may need to define an unsubnetted network using subnetting notation.

This might seem like a strange concept—if you aren't going to bother creating subnets, why do you need to consider how the old-fashioned classes are used under subnetting? The answer is that after subnetting became popular, most operating systems and networking hardware and software were designed under the assumption that subnetting would be used. Even if you decide not to subnet, you may need to express your unsubnetted network using a subnet mask.

In essence, a non-subnetted class A, B or C network can be considered the “default case” of the more general, custom-subnetted network. Specifically, it is the case where we choose to divide the host ID so that zero bits are used for the subnet ID and all the bits are used for the host ID. I realize that this seems like a bit of a semantic game. However, this default case is the basis for the more practical subnetting [we will examine in the next topic](#).

Just as is always the case, the subnet mask for a default, unsubnetted class A, B or C network has ones for each bit that is used for network ID or subnet ID, and zeroes for the host ID bits. Of course, we just said we aren't subnetting, so there **are** no subnet ID bits! Thus, the subnet mask for this default case has 1s for the network ID portion and 0s for the host ID portion. This is called the *default subnet mask* for each of the IP address classes.

Since classes A, B and C divide the network ID from the host ID on octet boundaries, the subnet mask will always have all ones or all zeroes in an octet. Therefore, the default subnet masks will always have 255s or 0s when expressed in decimal notation. [Table 52](#) summarizes the default subnet masks for each of the classes; they are also shown graphically in [Figure 68](#).

Table 52: Default Subnet Masks for Class A, Class B and Class C Networks

IP Address Class	Total # Of Bits For Network ID / Host ID	Default Subnet Mask			
		First Octet	Second Octet	Third Octet	Fourth Octet
Class A	8 / 24	11111111 (255)	00000000 (0)	00000000 (0)	00000000 (0)
Class B	16 / 16	11111111 (255)	11111111 (255)	00000000 (0)	00000000 (0)
Class C	24 / 8	11111111 (255)	11111111 (255)	11111111 (255)	00000000 (0)

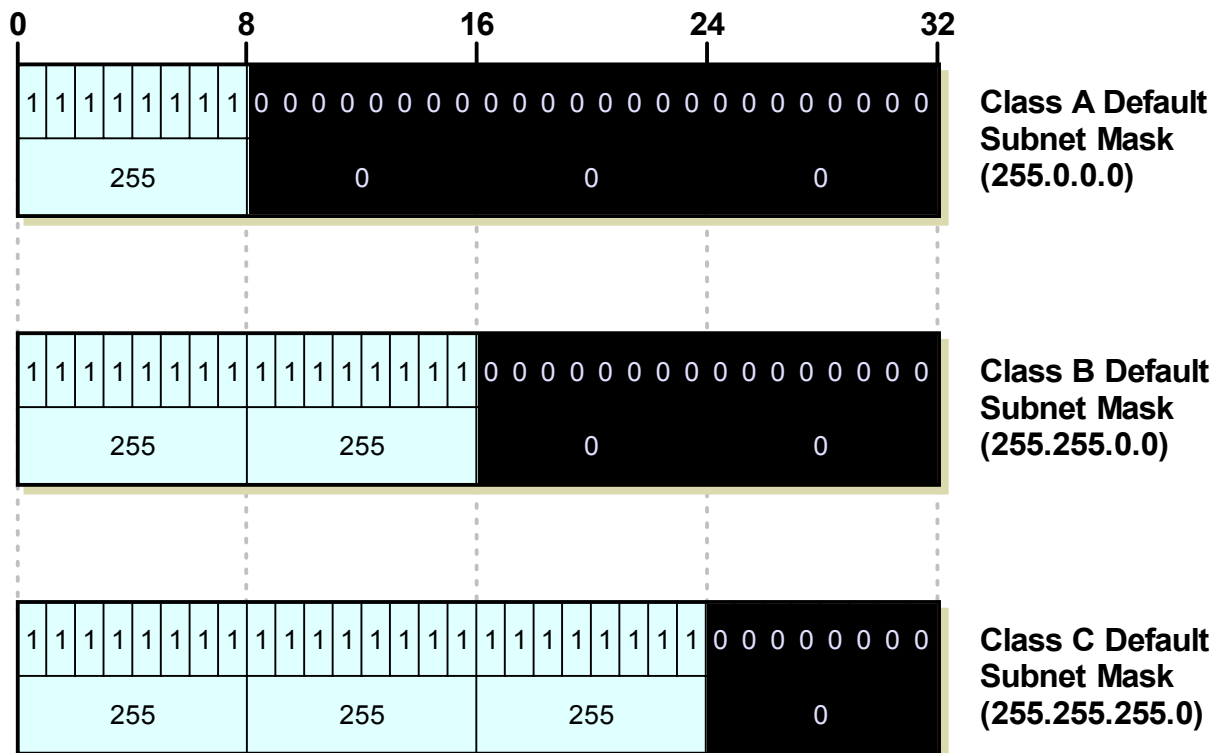

Figure 68: Default Subnet Masks for Class A, Class B and Class C Networks

So, the three default subnet masks are 255.0.0.0 for Class A, 255.255.0.0 for class B, and 255.255.255.0 for Class C. Note that while all default subnet masks use only “255” and “0”, not all subnet masks with “255” and “0” are defaults. There are a small number of custom subnets that divide on octet boundaries as well. These are:

- ☉ **255.255.0.0:** This is the default mask for Class B, but can also be the custom subnet mask for dividing a Class A network using 8 bits for the subnet ID (leaving 16 bits for the host ID).
- ☉ **255.255.255.0:** This is the default subnet mask for Class C, but can be a custom Class A with 16 bits for the subnet ID *or* a Class B with 8 bits for the subnet ID.



Key Concept: Each of the three IP unicast/broadcast address classes, A, B and C, has a *default subnet mask* defined that has a one for each bit of the class’s network ID, a zero bit for each bit of its host ID, and no subnet ID bits. The three default subnet masks are 255.0.0.0 for Class A, 255.255.0.0 for class B, and 255.255.255.0 for Class C.

IP Custom Subnet Masks

It's important to understand what [default subnet masks](#) are and how they work. A default subnet mask doesn't really represent subnetting, however, since it is the case where we are assigning zero bits to the subnet ID. To do “real” subnetting we must dedicate at least one of the bits of the pre-subnetted host ID to the subnet ID, as shown in [the example in the topic that introduced subnet masks](#).

Since we have the ability to customize our choice of dividing point between subnet ID and host ID to suit the needs of our network, this is sometimes called *customized subnetting*. The subnet mask that we use when creating a customized subnet is, in turn, called a *custom subnet mask*. The custom subnet mask is used by network hardware to determine how we have decided to divide the subnet ID from the host ID in our network.

Deciding How Many Subnet Bits to Use

The key decision in customized subnetting is how many bits to take from the host ID portion of the IP address to put into the subnet ID. Recall that the number of subnets possible on our network is two to the power of the number of bits we use to express the subnet ID, and the number of hosts possible per subnet is two to the power of the number of bits left in the host ID (less two, which I will explain later in this topic).

Thus, the decision of how many bits to use for each of the subnet ID and host ID represents a fundamental trade-off in subnet addressing:

- ☉ Each bit taken from the host ID for the subnet ID doubles the number of subnets that are possible in the network.
- ☉ Each bit taken from the host ID for the subnet ID (approximately) halves the number of hosts that are possible within each subnet on the network.

Subnetting Bit Allocation Options

Let's take a brief example or two to see how this works. Imagine that we start with a Class B network with the network address 154.71.0.0. Since this is Class B, 16 bits are for the network ID (154.71) and 16 are for the host ID. In the default case there are no subnets (well, one "subnet" that is the whole network) and 65,534 hosts total. To subnet this network, we have a number of choices:

1. We can decide to use 1 bit for the subnet ID and 15 bits for the host ID. If we do this, then the total number of subnets is 2^1 or 2: the first subnet is 0 and the second is 1. The number of hosts available for each subnet is $2^{15}-2$ or 32,766.
2. We can use 2 bits for the subnet ID and 14 for the host ID. In this case, we double the number of subnets: we now have 2^2 or 4 subnets: 00, 01, 10 and 11 (subnets 0, 1, 2 and 3). But the number of hosts is now only $2^{14}-2$ or 16,382.
3. We can use any other combination of bits that add up to 16, as long as they allow us at least 2 hosts per subnet: 4 and 12, 5 and 11, and so on.

Trading Off Bit Allocations To Meet Subnetting Requirements

How do we decide how to divide the "classful" host ID into subnet ID and host ID bits? This is the key design decision in subnetting. We must make this choice based on our requirements for the number of subnets that exist in the network, and also on the maximum number of hosts that need to be assigned to each subnet in the network. For example, suppose we have 10 total subnets for our Class B network. We need 4 bits to represent this, because 2^4 is 16 while 2^3 is only 8. This leaves 12 bits for the host ID, for a maximum of 4,094 hosts per subnet.

However, suppose instead that we have 20 subnets. If so, 4 bits for subnet ID won't suffice: we need 5 bits ($2^5=32$). This means in turn that we now have only 11 bits for the host ID, for a maximum of 2,046 hosts per subnet. [Step #2 of the practical subnetting example discusses these decisions in more detail.](#)

Now, what happens if we have 20 subnets and also need a maximum of 3,000 hosts per subnet? Well, we have a problem. We need 5 bits to express 20 different subnets. However, we need 12 bits to express the number 3,000 for the host ID. That's 17 bits—too many. The solution? We might be able to shuffle our physical networks so that we only have 16. If not, we need a second Class B network.

It's also important to realize that in regular subnetting, the choice of how many bits to use for the subnet ID is fixed for the entire network. You can't have subnets of different sizes—they must all be the same. Thus, the number of hosts in **the largest subnet** will dictate how many bits you need for the host ID. This means that in the case above, if you had a strange configuration where 19 subnets had only 100 hosts each but the 20th had 3,000, you'd have a problem. If this were the case, you could solve the problem easily by dividing that one oversized subnet into two or more smaller ones. An enhancement to subnetting called [Variable Length Subnet Masking \(VLSM\)](#) was created in large part to remove this restriction.



Note: I have included [summary tables](#) that show the trade-off in subnetting each of Classes A, B and C, and the subnet mask for each of the choices.



Key Concept: The fundamental trade-off in subnetting: each addition of a bit to the subnet ID (and thus, subtraction of that bit from the host ID) doubles the number of subnets, and approximately halves the number of hosts in each subnet. Each subtraction of a bit from the subnet ID (and addition of that bit to the host ID) does the opposite.

Determining the Custom Subnet Mask

Once we have determined how many bits we are going to devote to the subnet ID and the host ID, we can figure out the subnet mask. This is fairly easy to do, now that we understand how subnetting works. We begin with the default subnet mask in binary for the appropriate class of our network. We then start with the left-most zero in that mask and change as many bits to 1 as we have dedicated to the subnet ID. We can then express the subnet mask in dotted decimal form. [Figure 69](#) shows how the custom subnet mask can be determined for each of the subnetting options of a Class C network, in both binary and decimal.

So, to take the example in that figure, consider the Class C network 200.13.94.0. There are 8 bits in the original host ID, which gives us six different subnetting options (we can't use 7 or 8 bits for the subnet ID, for reasons we will discuss shortly.) Suppose we use three of these for the subnet ID and five are left for the host ID. To determine the custom subnet mask, we start with the Class C default subnet mask:

```
11111111 11111111 11111111 00000000
```

We then change the first three zeroes to ones, to get the custom subnet mask:

```
11111111 11111111 11111111 11100000
```

In dotted decimal format, this is 255.255.255.224.



Key Concept: Once the choice of how to subnet has been made, the custom subnet mask is determined simply, by starting with the default subnet mask for the network and changing each subnet ID bit from a 0 to a 1.

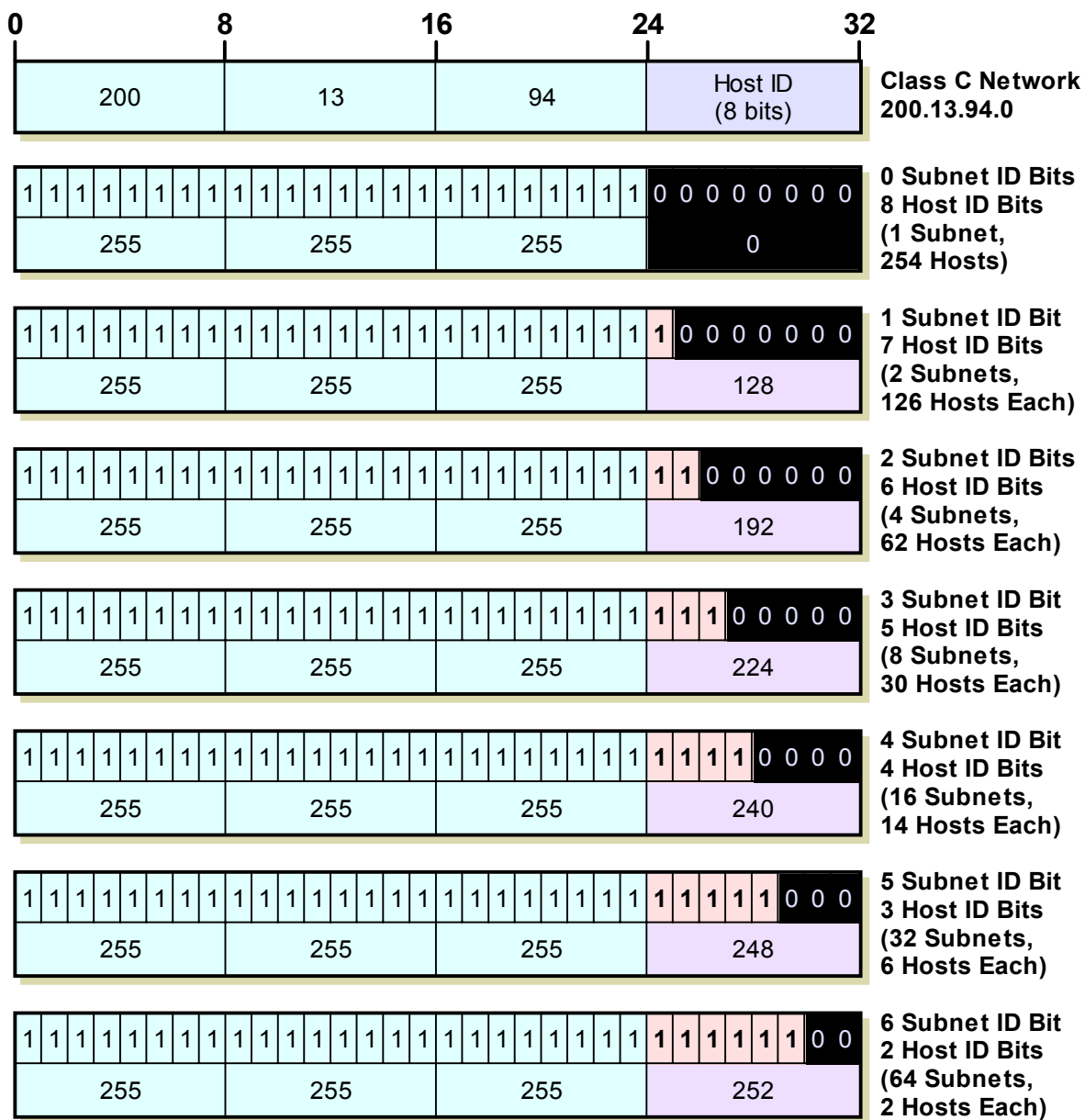

Figure 69: Custom Subnet Masks for Class C Networks

Since there are 8 host ID bits in a Class C network address, there are six different ways that the network can be subnetted. Each corresponds to a different custom subnet mask, which is created by changing the allocated subnet ID bits from zero to one.

Subtracting Two From the Number of Hosts Per Subnet and (Possibly) Subnets Per Network

There's one more issue that needs to be explained regarding the split into subnet ID and host ID. We've already seen how in regular "classful" addressing, we must subtract 2 from the number of hosts allowed in each network. This is necessary because two host IDs in each subnet have "special meanings": the all-zeroes host ID meaning "this network", and

the all-ones host ID which is a broadcast to “all hosts on the network”. These restrictions apply also to each subnet under subnetting too, which is why we must continue to subtract 2 from the number of hosts per subnet. (This is also why dividing the 8 host ID bits of a Class C network into 7 bits for subnet ID and 1 bit for host ID is not just silly, but in fact meaningless: it leaves $2^1-2=0$ hosts per subnet. Not particularly useful.)

There is a similar issue that occurs with the subnet ID as well. When subnetting was originally defined in RFC 950, the standard specifically excluded the use of the all-zeroes and all-ones subnets. This was due to concern that routers might become confused by these cases. A later standard, RFC 1812 (*Requirements for IP Version 4 Routers*) removed this restriction in 1995. Thus, modern hardware now has no problem with the all-zeroes or all-ones subnets, but some very old hardware may still balk at it.



Key Concept: The number of hosts allowed in each subnet is the binary power of the number of host ID bits remaining after subnetting, **less two**. The reduction by two occurs because the all-zeroes and all-ones host IDs within each subnet are reserved for two “special meaning” addresses: to refer to the subnetwork itself and its local broadcast address. In some implementations, the number of subnets is also reduced by two because the all-zeroes and all-ones subnet IDs were originally not allowed to be used.

For this reason, you will sometimes see discussions of subnetting that exclude these cases. When that is done, you lose 2 potential subnets: the all-zeroes and all-ones subnets. If you do this, then choosing 1 bit for subnet ID is no longer valid, as it yields $2^1-2=0$ subnets. You must choose 2 bits if you need 2 subnets.



Note: In this Guide I assume we are dealing with modern hardware and do not exclude the all-zeroes and all-ones subnets, but I do try to make explicit note of this fact wherever relevant.

IP Subnet Identifiers, Subnet Addresses and Host Addresses

The main advantage of [conventional “classful” addressing without subnets](#) is its simplicity. Even though we've seen that there can be problems with how to manage thousands of devices in a single Class B network, for example, there is little complexity in how to assign addresses within the network. They are all lumped together, so any combination of bits can be used within the host ID (except for all-zeroes and all-ones, which are [special](#)).

When we subnet, however, we [create a two-level structure within the “classful” host ID](#)—subnet ID and host ID. This means we must choose IP addresses for devices more carefully. In theory, we are selecting subnets to correspond to our physical networks within the organization, so we want to assign IP addresses in a way that is consistent with our physical network structure.

Subnet Identifiers

Once we decided how many subnets we are going to have, we need to identify the subnets and determine what the addresses are for the subnets. Let's start by looking at the *subnet identifier*. This is just the *subnet ID* of any of the subnets in our network. Subnets are numbered starting with 0 and increasing up to one less than the maximum number of subnets, which is a function of how many bits are in the subnet ID. (If the all-zero and all-one subnet IDs are excluded as specified in RFC 950 then the first subnet identifier is one).

Of course, we may not need all of the subnets that can theoretically be defined. For example, if we have 20 subnets, we need 5 bits for the subnet identifier, which allows a theoretical maximum of 32 subnets. We would use only subnets 0 to 19; 20 through 31 would be reserved for future use. These subnets could be expressed either in decimal form (0, 1, 2 ... up to 19) or in binary (00000, 00001, 00010 ... up to 10011).

Subnet Addresses

For each subnet we can also determine the *subnet address*. To do this we start with the IP address for the overall network, which recall has all zeroes in the "classful" host ID field (8 bits, 16 bits or 24 bits). We then insert the subnet identifier for a particular subnet into the designated subnet bits.

As an example, let's refer back to the subnetting of a Class B network, 154.71.0.0, shown in Figure 66. We used five subnet ID bits there. We start with the following network IP address, with the subnet ID bits highlighted:

10011010 01000111 00000000 00000000

To find the address of say, subnet #11, we would substitute "01011" for these bits, leaving the host ID bits zero:

10011010 01000111 01011000 00000000

We can then convert this from binary form to dotted decimal, resulting in a subnet address of 154.71.88.0.



Key Concept: The *subnet identifier* of a subnet is just its subnet ID. The subnet address of a subnet is determined by substituting its subnet ID into the subnet bits of the overall network address.

Subnet Address Formulas

Notice when looking at subnet addressing that when you substitute subnet IDs in sequence, a pattern becomes immediately visible. The first subnet address is always the address of the overall network, because the subnet ID is all zeroes. Then, the second subnet address in decimal form is found by adding a specific multiple of two to one of the octets. The third address is then found by adding this same number to the second address, and so on.

In fact, I realized that the decimal value of each subnet address can be expressed as a formula, based on the class of the original network and the number of bits being used for the subnet ID. For example, consider a Class B network with overall address of “x.y.0.0” (it doesn’t matter what “x” and “y” are for our purposes). Now, say we are using two bits for the subnet ID. We have four subnet addresses here:

1. The address of subnet #0 will be the same as the network address: x.y.0.0.
2. The address of subnet #1 will be found by substituting “01” for the first two bits of the third octet. This yields an address of “x.y.01000000.00000000”, or “x.y.64.0” in straight decimal.
3. Subnet #2’s address is found by substituting “10” for the subnet ID bits, so it is “x.y.10000000.00000000”, or “x.y.128.0” in straight decimal.
4. Subnet #3’s address will be “x.y.192.0”.

So, the formula in this case for subnet #N is “x.y.N*64.0”. If we use five bits for a subnet, the formula is “x.y.N*8.0”; as we saw above, the subnet address for subnet #11 in network 154.71.0.0 is 154.71.88.0. I have shown the formulas for all of the combinations of subnet ID and host ID size in [the subnetting summary tables](#). These formulas may seem a bit confusing at first, but they can be a real time-saver once you become more familiar with subnetting.

Host Addresses Within Each Subnet

Once we know the subnet address for a particular subnet, assigning IP addresses is easy. We just plug in values into the remaining host ID bits. Of course, we skip the all-zeroes value, so the first host in the subnet has all zeroes for the host ID except for a one in the right-most bit position. Then the next host has all zeroes except for “10” at the end (two in decimal). We can do this all the way up to one less than the all-ones value. Again, we then convert each IP address from binary to decimal.

Some more examples would definitely help you understand much better how these addresses are determined. This requires us to deal with a large number of nitty-gritty details and lots of binary numbers. [You can find exactly these details in the section on practical subnetting.](#)

IP Subnetting Summary Tables For Class A, Class B and Class C Networks

Since there are only a few options for how to subnet each of Class A, Class B and Class C networks, I have listed the options for each class in three summary tables below: [Table 53](#), [Table 54](#) and [Table 55](#). These tables can help you quickly **decide how many bits to use for subnet ID and host ID**, and then what the subnet mask is for their selection. They also summarize nicely what we've discussed in this section.

Each row of each table shows one possible subnetting option for that class, including the number of bits for each of the subnet ID and host ID, and the number of subnets and hosts based on the number of bits. I then show the subnet mask in binary and decimal form, as well as in [CIDR notation](#). Finally, I include the formula for calculating the addresses for each subnet under each of the options.

Notes on the Three Subnetting Summary Tables

A few additional explanatory notes are in order regarding these tables:

- ☉ The values for the number of subnets per network assume that the all-zeroes and all-ones subnets are allowed. **If not, you must subtract 2 from those figures**; this also means that the option using only one bit for the subnet ID becomes invalid, and the subnet address formulas no longer work as shown.
- ☉ The number of hosts per subnet **does** exclude the all-zeroes and all-ones cases, so it is two to the power of the number of host ID bits, less two.
- ☉ The first row of each table shows the “default” case where the number of subnet bits is zero, and thus the subnet mask is the **default subnet mask for the class**.
- ☉ In the subnet mask for all options but the default, I have highlighted the portion of the subnet mask corresponding to the subnet ID, for clarity. This has been done for each individual bit of the binary mask, and for each octet in the dotted decimal representation of the mask where part of the subnet ID is found.
- ☉ You will see that not all of the divisions make a great deal of sense in the real world... though you might be surprised. For example, at first glance it seems silly to think that we might want to assign 14 bits of a Class B host ID to the subnet ID and leave 2 bits for the host ID—what sort of real network has 16,384 subnets with 2 hosts on each? Yet some larger Internet service companies may indeed require thousands of tiny subnets when setting up connections between routers, or between their core network and their customers.
- ☉ The subnet address formulas in the last column of each table show the address for subnet #N (numbering from zero up to one less than the maximum number of subnets). **See the end of step #4 in the step-by-step subnetting section** for a full explanation of how these formulas work.

Class A

Table 53: Subnetting Summary Table For Class A Networks (Page 1 of 2)

# of Subnet ID Bit	# of Host ID Bits	# of Subnets Per Network	# of Hosts Per Subnet	Subnet Mask (Binary / Dotted Decimal)	Subnet Mask (Slash/CIDR Notation)	Subnet Address #N Formula (N=0, 1, ... # of Subnets-1)
0 (Default)	24	1	16,277,214	11111111.00000000.00000000.00000000 255.0.0.0	/8	—
1	23	2	8,388,606	11111111.10000000.00000000.00000000 255.128.0.0	/9	x.N*128.0.0
2	22	4	4,194,302	11111111.11000000.00000000.00000000 255.192.0.0	/10	x.N*64.0.0
3	21	8	2,097,150	11111111.11100000.00000000.00000000 255.224.0.0	/11	x.N*32.0.0
4	20	16	1,048,574	11111111.11110000.00000000.00000000 255.240.0.0	/12	x.N*16.0.0
5	19	32	524,286	11111111.11111000.00000000.00000000 255.248.0.0	/13	x.N*8.0.0
6	18	64	262,142	11111111.11111100.00000000.00000000 255.252.0.0	/14	x.N*4.0.0
7	17	128	131,070	11111111.11111110.00000000.00000000 255.254.0.0	/15	x.N*2.0.0
8	16	256	65,534	11111111.11111111.00000000.00000000 255.255.0.0	/16	x.N.0.0
9	15	512	32,766	11111111.11111111.10000000.00000000 255.255.128.0	/17	x.N/2. (N%2)*128.0
10	14	1,024	16,382	11111111.11111111.11000000.00000000 255.255.192.0	/18	x.N/4. (N%4)*64.0
11	13	2,048	8,190	11111111.11111111.11100000.00000000 255.255.224.0	/19	x.N/8. (N%8)*32.0
12	12	4,096	4,094	11111111.11111111.11110000.00000000 255.255.240.0	/20	x.N/16. (N%16)*16.0
13	11	8,192	2,046	11111111.11111111.11111000.00000000 255.255.248.0	/21	x.N/32. (N%32)*8.0
14	10	16,384	1,022	11111111.11111111.11111100.00000000 255.255.252.0	/22	x.N/64. (N%64)*4.0
15	9	32,768	510	11111111.11111111.11111110.00000000 255.255.254.0	/23	x.N/128. (N%128)*2.0
16	8	65,536	254	11111111.11111111.11111111.00000000 255.255.255.0	/24	x.N/256. N%256.0
17	7	131,072	126	11111111.11111111.11111111.10000000 255.255.255.128	/25	x.N/512. (N/2)%256. (N%2)*128

Table 53: Subnetting Summary Table For Class A Networks (Page 2 of 2)

# of Subnet ID Bit	# of Host ID Bits	# of Subnets Per Network	# of Hosts Per Subnet	Subnet Mask (Binary / Dotted Decimal)	Subnet Mask (Slash/CIDR Notation)	Subnet Address #N Formula (N=0, 1, ... # of Subnets-1)
18	6	262,144	62	11111111. 11111111.11111111.11 000000 255. 255.255.192	/26	x.N/1024. (N/4)%256. (N%4)*64
19	5	524,288	30	11111111. 11111111.11111111.111 00000 255. 255.255.224	/27	x.N/2048. (N/8)%256. (N%8)*32
20	4	1,048,576	14	11111111. 11111111.11111111.1111 0000 255. 255.255.240	/28	x.N/4096. (N/16)%256. (N%16)*16
21	3	2,097,152	6	11111111. 11111111.11111111.11111 000 255. 255.255.248	/29	x.N/8192. (N/32)%256. (N%32)*8
22	2	4,194,304	2	11111111. 11111111.11111111.111111 00 255. 255.255.252	/30	x.N/16384. (N/64)%256. (N%64)*4

Class B

Table 54: Subnetting Summary Table For Class B Networks

# of Subnet ID Bit	# of Host ID Bits	# of Subnets Per Network	# of Hosts Per Subnet	Subnet Mask (Binary / Dotted Decimal)	Subnet Mask (Slash/CIDR Notation)	Subnet Address #N Formula (N=0, 1, ... # of Subnets-1)
0 (Default)	16	1	65,534	11111111.11111111.00000000.00000000 255.255.0.0	/16	--
1	15	2	32,766	11111111.11111111.10000000.00000000 255.255.128.0	/17	x.y.N*128.0
2	14	4	16,382	11111111.11111111.11000000.00000000 255.255.192.0	/18	x.y.N*64.0
3	13	8	8,190	11111111.11111111.11100000.00000000 255.255.224.0	/19	x.y.N*32.0
4	12	16	4,094	11111111.11111111.11110000.00000000 255.255.240.0	/20	x.y.N*16.0
5	11	32	2,046	11111111.11111111.11111000.00000000 255.255.248.0	/21	x.y.N*8.0
6	10	64	1,022	11111111.11111111.11111100.00000000 255.255.252.0	/22	x.y.N*4.0
7	9	128	510	11111111.11111111.11111110.00000000 255.255.254.0	/23	x.y.N*2.0
8	8	256	254	11111111.11111111.11111111.00000000 255.255.255.0	/24	x.y.N.0
9	7	512	126	11111111.11111111.11111111.10000000 255.255.255.128	/25	x.y.N/2. (N%2)*128
10	6	1,024	62	11111111.11111111.11111111.11000000 255.255.255.192	/26	x.y.N/4. (N%4)*64
11	5	2,048	30	11111111.11111111.11111111.11100000 255.255.255.224	/27	x.x.N/8. (N%8)*32
12	4	4,096	14	11111111.11111111.11111111.11110000 255.255.255.240	/28	x.y.N/16. (N%16)*16
13	3	8,192	6	11111111.11111111.11111111.11111000 255.255.255.248	/29	x.y.N/32. (N%32)*8
14	2	16,384	2	11111111.11111111.11111111.11111100 255.255.255.252	/30	x.y.N/64. (N%64)*4

Class C

Table 55: Subnetting Summary Table For Class C Networks

# of Subnet ID Bit	# of Host ID Bits	# of Subnets Per Network	# of Hosts Per Subnet	Subnet Mask (Binary / Dotted Decimal)	Subnet Mask (Slash/CIDR Notation)	Subnet Address #N Formula (N=0, 1, ... # of Subnets-1)
0 (Default)	8	1	254	11111111.11111111.11111111.00000000 255.255.255.0	/24	—
1	7	2	126	11111111.11111111.11111111.10000000 255.255.255.128	/25	x.y.z.N*128
2	6	4	62	11111111.11111111.11111111.11000000 255.255.255.192	/26	x.y.z.N*64
3	5	8	30	11111111.11111111.11111111.11100000 255.255.255.224	/27	x.y.z.N*32
4	4	16	14	11111111.11111111.11111111.11110000 255.255.255.240	/28	x.y.z.N*16
5	3	32	6	11111111.11111111.11111111.11111000 255.255.255.248	/29	x.y.z.N*8
6	2	64	2	11111111.11111111.11111111.11111100 255.255.255.252	/30	x.y.z.N*4

IP Variable Length Subnet Masking (VLSM)

Conventional [Subnet masking](#) replaces the two-level IP addressing scheme with a more flexible three-level method. Since it lets network administrators assign IP addresses to hosts based on how they are connected in physical networks, subnetting is a real breakthrough for those maintaining large IP networks. It has its own weaknesses though, and still has room for improvement. The main weakness of conventional subnetting is in fact that the subnet ID represents only *one* additional hierarchical level in how IP addresses are interpreted and used for routing.

The Problem With Single-Level Subnetting

It may seem “greedy” to look at subnetting and say “what, only *one* additional level”? ☺ However, in large networks, the need to divide our entire network into only one level of subnetworks doesn't represent the best use of our IP address block. Furthermore, we have already seen that since the subnet ID is the same length throughout the network, we can have problems if we have subnetworks with very different numbers of hosts on them—the subnet ID must be chosen based on whichever subnet has the greatest number of hosts, even if most of subnets have far fewer. This is inefficient even in small networks, and can result in the need to use extra addressing blocks while wasting many of the addresses in each block.

For example, consider a relatively small company with a Class C network, 201.45.222.0/24. They have six subnetworks in their network. The first four subnets (S1, S2, S3 and S4) are relatively small, containing only 10 hosts each. However, one of them (S5) is for their production floor and has 50 hosts, and the last (S6) is their development and engineering group, which has 100 hosts.

The total number of hosts needed is thus 196. Without subnetting, we have enough hosts in our Class C network to handle them all. However, when we try to subnet, we have a big problem. In order to have six subnets we need to use 3 bits for the subnet ID. This leaves only 5 bits for the host ID, which means every subnet has the identical capacity of 30 hosts, as shown in [Figure 70](#). This is enough for the smaller subnets but not enough for the larger ones. The only solution with conventional subnetting, other than shuffling the physical subnets, is to get another Class C block for the two big subnets and use the original for the four small ones. But this is expensive, and means wasting hundreds of IP addresses!

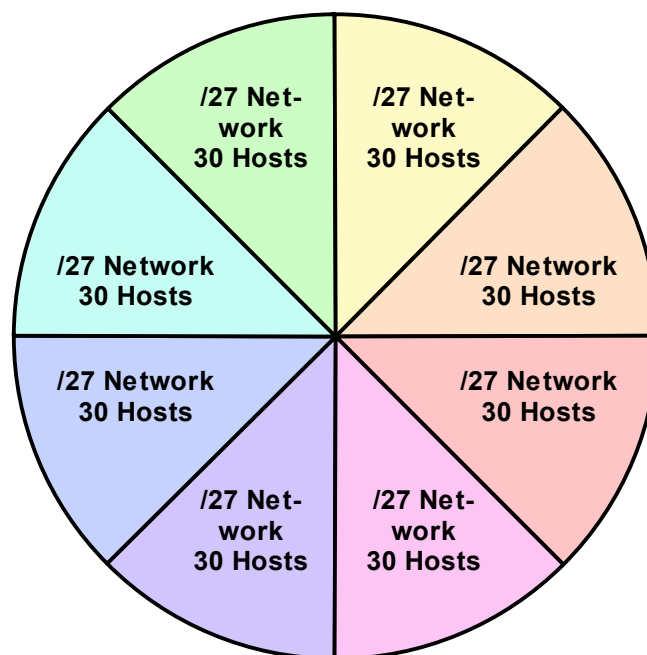

Class C (/24) Network (254 Hosts)

Figure 70: Class C (/24) Network Split Into Eight Conventional Subnets

With traditional subnetting, all subnets must be the same size, which creates problems when there are some subnets that are much larger than others. Contrast to [Figure 71](#).

The Solution: Variable Length Subnet Masking

The solution to this situation is an enhancement to the basic subnet addressing scheme called *Variable Length Subnet Masking (VLSM)*. VLSM seems complicated at first, but is easy to comprehend if you understand basic subnetting. The idea is that you subnet the network, and then subnet the subnets just the way you originally subnetted the network. In

fact, you can do this multiple times, creating subnets of subnets of subnets, as many times as you need (subject to how many bits you have in the host ID of your address block). It is possible to choose to apply this multiple-level splitting to only some of the subnets, allowing you to selectively cut the "IP address pie" so that some of the slices are bigger than others. This means that our example company could create six subnets to match the needs of its networks, as shown in [Figure 71](#).

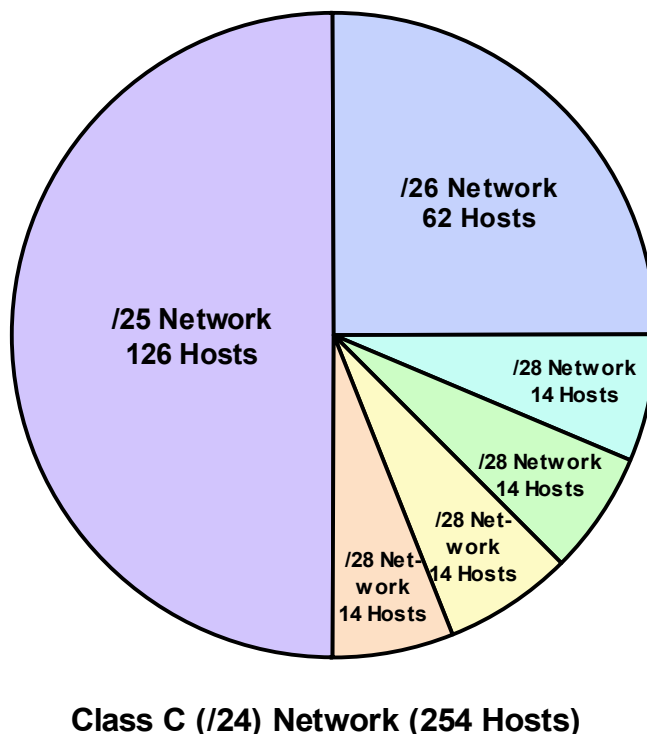

Figure 71: Class C (/24) Network Split Using Variable Length Subnet Masking (VLSM)
Using VLSM, an organization can divide its IP network multiple times, to create subnets that much better match the size requirements of its physical networks. Contrast to [Figure 70](#).



Key Concept: *Variable Length Subnet Masking (VLSM)* is a technique where subnetting is performed multiple times in iteration, to allow a network to be divided into a hierarchy of subnetworks that vary in size. This allows an organization to much better match the size of its subnets to the requirements of its networks.

An Example: Multiple-Level Subnetting Using VLSM

VLSM subnetting is done the same way as regular subnetting; it is just more complex because of the extra levels of subnetting hierarchy. You do an initial subnetting of the network into large subnets, and then further break down one or more of the subnets as required. You add bits to the subnet mask for each of the "sub-subnets" and "sub-sub-

subnets" to reflect their smaller size. In VLSM, the [slash notation of classless addressing](#) is commonly used instead of binary subnet masks—VLSM is very much like [CIDR](#) in how it works—so that's what I will use.



Note: Before proceeding to the VLSM example that follows, a suggestion: if you aren't feeling comfortable with how basic subnetting works, you probably want to read through [the section on practical subnetting](#) first. Trust me. 😊

Let's take our example above again and see how we can make everything fit using VLSM. We start with our Class C network, 201.45.222.0/24. We then do three subnettings as follows (see [Figure 72](#) for an illustration of the process):

1. We first do an initial subnetting by using one bit for the subnet ID, leaving us 7 bits for the host ID. This gives us two subnets: 201.45.222.0/25 and 201.45.222.128/25. Each of these can have a maximum of 126 hosts. We set aside the first of these for subnet S6 and its 100 hosts.
2. We take the second subnet, 201.45.222.128/25, and subnet it further into two sub-subnets. We do this by taking one bit from the 7 bits left in the host ID. This gives us the sub-subnets 201.45.222.128/26 and 201.45.222.192/26, each of which can have 62 hosts. We set aside the first of these for subnet S5 and its 50 hosts.
3. We take the second sub-subnet, 201.45.222.192/26, and subnet it further into four sub-sub-subnets. We take 2 bits from the 6 that are left in the host ID. This gives us four sub-sub-subnets that each can have a maximum of 14 hosts. These are used for S1, S2, S3 and S4.

Okay, I *did* get to pick the numbers in this example so that they work out just perfectly, but you get the picture. VLSM greatly improves both the flexibility and the efficiency of subnetting. In order to use it, routers that support VLSM-capable routing protocols must be employed. VLSM also requires more care in how routing tables are constructed to ensure that there is no ambiguity in how to interpret an address in the network.

As I said before, VLSM is similar in concept to the way [classless addressing and routing \(CIDR\)](#) is performed. The difference between VLSM and CIDR is primarily one of focus. VLSM deals with subnets of a single network in a private organization. CIDR takes the concept we just saw in VLSM to the Internet as a whole, by changing how organizational networks are allocated by replacing the single-level "classful" hierarchy with a multiple-layer hierarchy.



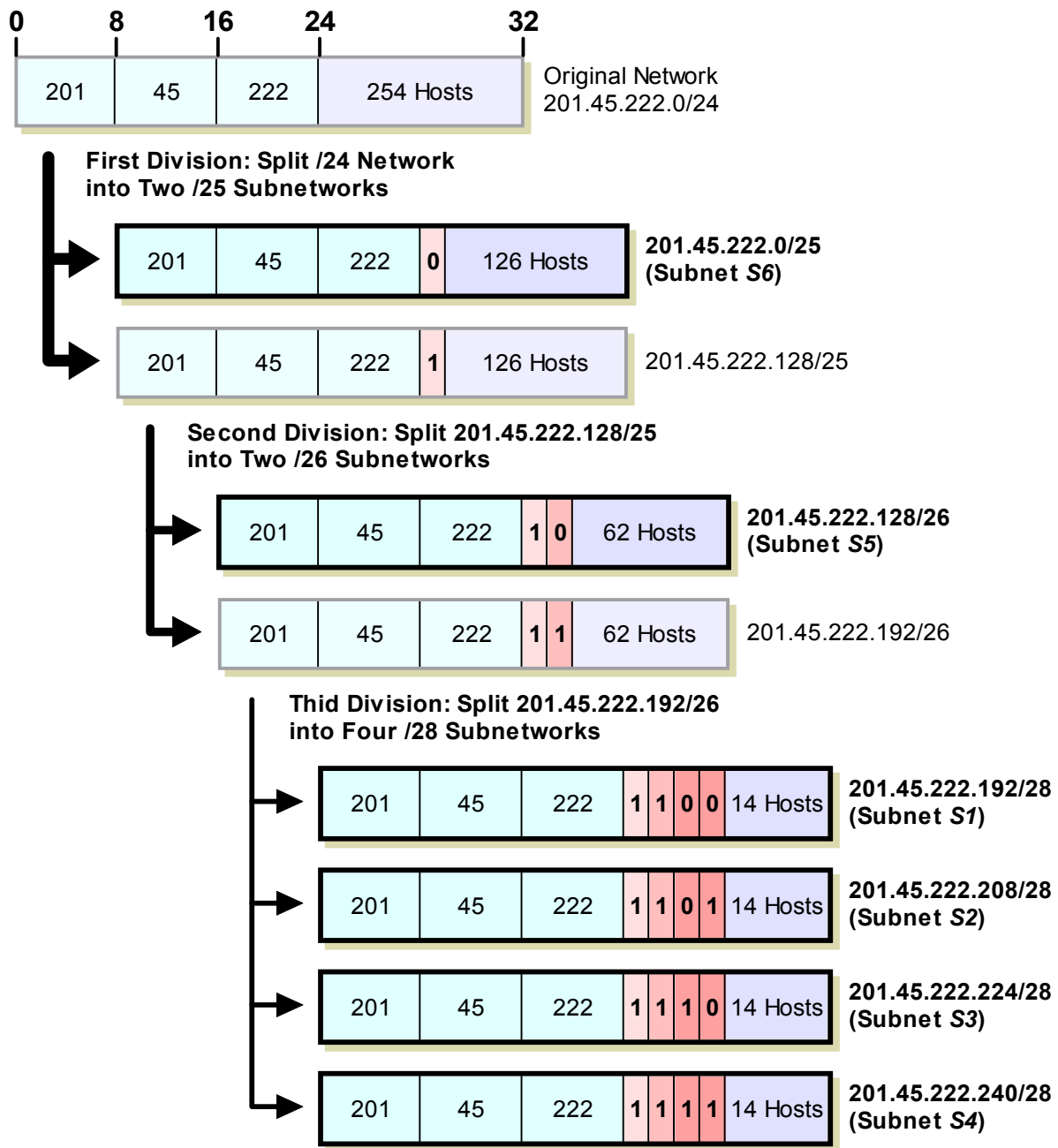

Figure 72: Variable Length Subnet Masking (VLSM) Example

This diagram illustrates the example described in the text, of a Class C (/24) network divided using three hierarchical levels. It is first divided into two subnets; one subnet is divided into two *sub-subnets*; and one sub-subnet is divided into four *sub-sub-subnets*. The resulting six subnets are shown with thick black borders, and have a maximum capacity of 126, 62, 14, 14, 14 and 14 hosts.

IP Subnetting: Practical Subnet Design and Address Determination Example

When educators ask students what they consider to be the most confusing aspect in learning about networking, many say that it is IP address subnetting. While subnetting isn't all that difficult in concept, it can be a bit mind-boggling in part due to the manipulations of binary numbers required. Many people understand the ideas behind subnetting but find it hard to follow the actual steps required to subnet a network.

For this reason, even though I [explained the concepts behind subnetting in detail in the previous section](#), I felt it would be valuable to have another section that provides a step-by-step look at how to perform custom subnetting. This section divides subnetting into five relatively straight-forward stages that cover determining requirements, making the design decision of how many bits to use for subnet ID and host ID, and then determining important numbers such as the subnet mask, subnet addresses and host addresses.

My focus in this section is on showing the practical “how” of subnetting. The topics here work through two examples using a Class B and a Class C sample network to show you how subnetting is done, and I am explicit in showing how everything is calculated. This means the section is a bit “number-heavy”. Also, I try not to duplicate conceptual issues covered in the previous section, though a certain amount of overlap does occur. Overall, if you are not familiar with how subnetting works at all, you will want to [read that section first](#). I do refer to topics in that section where appropriate, especially the [summary tables](#). Incidentally, I only cover conventional subnetting here, not [VLSM](#).

This section may serve as a useful refresher or summary of subnetting for someone who is already familiar with the basics but just wants to review the steps performed in subnetting. Again, always bear in mind that subnetting is based on the older “classful” [IP addressing scheme](#), and today's Internet is [classless, using CIDR](#).



Background Information: If you are not familiar with binary numbers, binary-to-decimal conversion and masking, and you didn't take my advice in preceding sections to brush up on these concepts using the [background explanation of computational math](#), you *really* want to do that now.



Note: If in reading this section you find yourself wanting to do binary-to-decimal conversions or binary math, remember that most versions of Windows (and many other operating systems) have a calculator program that incorporates scientific functions.

IP Subnetting Step #1: Requirements Analysis

When you are building or upgrading a network as a whole, the first step isn't buying hardware, or figuring out protocols, or even design. It's *requirements analysis*, the process of determining what it is the network needs to do. Without this foundation, you risk implementing a network that may perfectly match your design—but not meet the needs of your organization. The exact same rule applies to subnetting as well. Before we look at the gory details of host addresses and subnet masks, we must decide how to subnet the network. To do that, we must understand the requirements of the network.

Key Subnetting Requirements

Analyzing the requirements of the network for subnetting isn't difficult, because there are only a few issues that we need to consider. Since requirements analysis is usually done by asking questions, here's a list of the most important questions in analyzing subnetting requirements:

- ① What class is our IP address block?
- ② How many physical subnets are on the network today? (A “physical subnet” generally refers to a broadcast domain on a LAN; a set of hosts on a physical network bounded by routers.)
- ③ Do we anticipate adding any more physical networks in the near future, and if so, how many?
- ④ How many hosts do we have in the largest of our subnets today?
- ⑤ How many hosts do we anticipate having in the largest subnet in the near future?

The first question is important because everything in subnetting is based around dividing up a [Class A, Class B or Class C network](#), so we need to know which we are dealing with. If we are in the process of designing a network from scratch and don't have a Class A, B or C block yet, then we will determine which we need based on the approximate size of the organization. After that, we need to determine two key numbers: how many physical subnets we have, and the maximum number of hosts per subnet.

Assessing Future Needs During Requirements Analysis

We need to analyze the requirements above not only for the present network, but for the *near future* as well. The current values for these two numbers represent how the network needs to be designed today. However, designing only for the present is not a good idea.

Suppose we have exactly four subnetworks in our network now. In theory, we could use only two bits for the subnet ID, since 2^2 is 4. However, if our company is growing rapidly, this would be a poor choice. When we need to add a fifth subnet we'd have a problem!

Similarly, consider the growth in the number of hosts in a subnet. If the current largest subnet has 60 hosts, you don't want 6a bits for the host ID, because that limits you to 62 hosts. You can divide large subnets into smaller ones, but this may just mean unnecessarily additional work.

So, what is the “near future”? The term is necessarily vague, because it depends on how far into the future the organization wants to look. On the one hand, planning for several years' growth can make sense, if you have enough IP addresses to do it. On the other, you don't want to plan too far out, since changes in the short term may cause you to completely redesign your network anyway.



Key Concept: To successfully subnet a network, you must begin by learning what the requirements of the network will be. The most important parameters to determine are the number of subnets required and the maximum number of hosts needed per subnet. Numbers should be based not just on present needs but requirements in the near future.

IP Subnetting Step #2: The Key Design Trade-off: Partitioning Network Address Host Bits

After we complete our brief [requirements analysis](#), we should know the two critical parameters that we must have in order to subnet our network: the number of subnets required for the network, and the maximum number of hosts per subnetwork. In using these figures to design our subnetted network, we will be faced with the key design decision in subnetting: how to divide the 8, 16 or 24 bits in the “classful” host ID into subnet ID and host ID.

Deciding How Many Bits to Use for the Subnet ID and Host ID

Put another way, we need to decide how many bits to “steal” from the host ID to use for the subnet ID. As I introduced in [the topic on custom subnet masks](#), the fundamental trade-off in choosing this number is as follows:

- ☉ Each bit taken from the host ID for the subnet ID doubles the number of subnets that are possible in the network.
- ☉ Each bit taken from the host ID for the subnet ID (approximately) halves the number of hosts that are possible within each subnet on the network.

There are six possible ways this decision can be made for a Class C network, as illustrated in [Figure 73](#).

The relationship between the bits and the number of subnets and hosts is as follows:

- ☉ The number of subnets allowed in the network is two to the power of the number of subnet ID bits.
- ☉ The number of hosts allowed per subnet is two to the power of the number of host ID bits, less two.

We subtract two from the number of hosts in each subnet to exclude the “[special meaning cases](#)” where the host ID is all zeroes or all ones. As I explained in [the topic on custom subnetting](#), this exclusion was originally also applied to the subnet ID, but is no longer in newer systems.

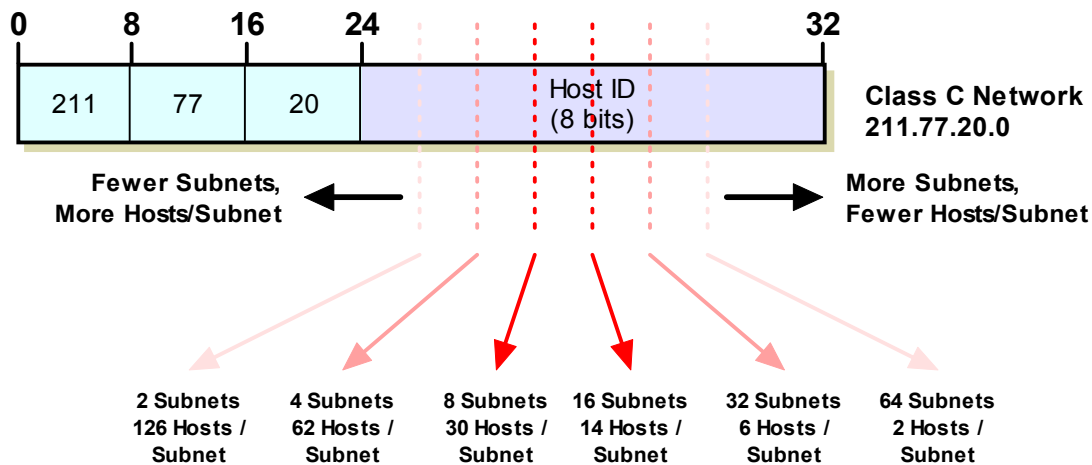

Figure 73: Subnetting Design Trade-Off For Class C Networks

Now, to choose how many bits to use for the subnet we could use *trial and error*. By this I mean we could try to first calculate the number of subnets and hosts when we use one bit for the subnet ID and leave the rest for the host ID. We could then try with two bits for the subnet ID, and then try with three and so on. This would be silly, however; it's time consuming and makes it hard for us to choose the best option. There's an easier method: we can use the [subnetting summary tables](#). They let us look at all our options and usually see immediately the best one for us.

Class C Subnetting Design Example

Let's take an example. Suppose we have a Class C network, base address 211.77.20.0, with a total of 7 subnets. The maximum number of hosts per subnet is 25. Looking at the subnetting summary table for Class C, the answer is instantly clear: we need 3 bits for the subnet ID. Why? This allows us 8 subnets and 30 hosts per subnet. If we try to choose 2 bits, we can't define enough subnets (only 4). As [Figure 74](#) shows, if we choose 4 bits for the subnet ID, then we can only have 14 hosts per subnet.

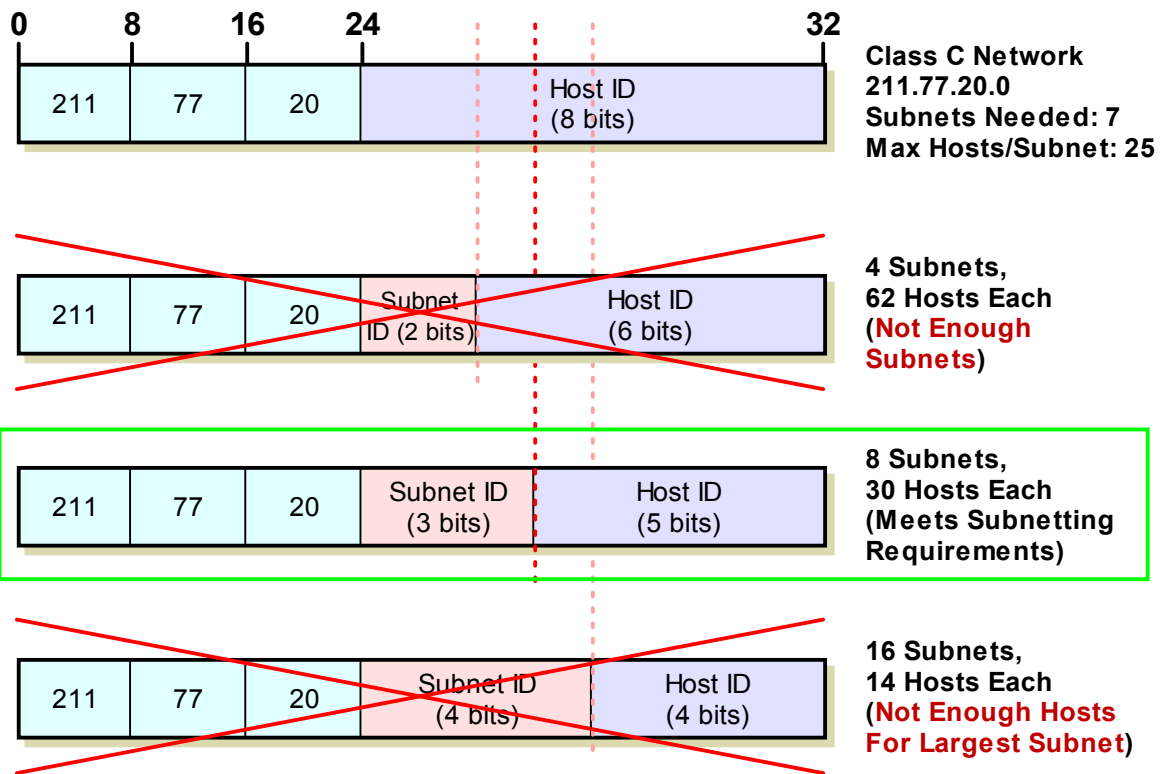

Figure 74: Example Class C Subnetting: An “Easy Decision”

In this particular example, where 7 subnets are needed and 25 hosts are needed for the largest subnet, there is only one choice of subnet ID size that meets the requirements.

Class B Subnetting Design Example

In some cases, especially with larger networks, we may have multiple choices. Consider a more interesting example, the larger Class B network 166.113.0.0, where we have a total of 15 subnets and the largest has 450 hosts. Examining the subnet summary table for Class B suggests four acceptable options, as shown in [Figure 75](#).

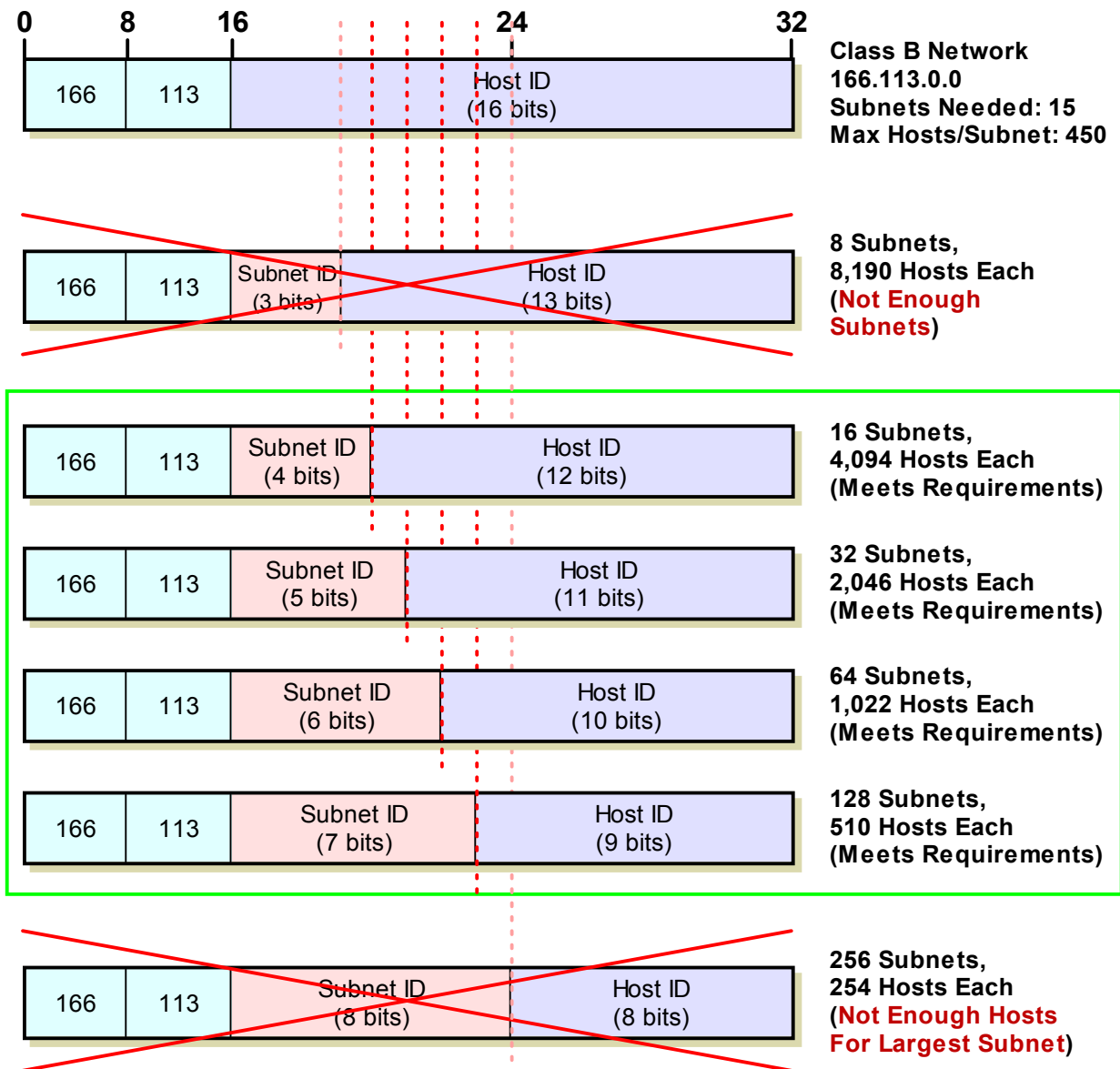

Figure 75: Example Class B Subnetting: A More Difficult Decision

This Class B network needs at least 15 subnets and must allow up to 450 host per subnet. Three subnet ID bits is too few, and 8 means only 254 hosts per subnet, which is insufficient, but there are four acceptable options, so we must choose wisely. ☺

In all four of these, the number of subnets is equal to 15 or greater, and the number of hosts per subnet is over 450. So, which option should we choose? Usually, we want to pick something *in the middle*. If we use 4 bits for the subnet ID, this gives us only a maximum of 16 subnets, which limits growth in the number of subnets, since we already have 15. The same applies to the choice of 7 bits for the subnet ID, since we already have 450 hosts in one subnet now, and that limits us to 510. Thus, we probably want either 5 or 6 bits here. If we expect more growth in the number of hosts in the largest subnet, we'd choose 5 bits; if we expect more growth in the number of subnets, we'd choose 6 bits. If unsure, it's probably best to assume more growth in the number of hosts per subnet, so here we would choose 5 bits.

The converse problem may also occur: you may be in a position where there are no rows in the table that will match. For example, if our Class C example has 35 hosts in the largest subnet instead of 25, we are out of luck: there is no combination of subnet ID and host ID size that works. The same is true in our Class B example if we had 4,500 hosts in that big subnet instead of 450. In this situation we must either divide the large subnet into a smaller one, use more than one IP address block, or upgrade to a larger block.



Key Concept: If there is more than one combination of subnet ID and host ID sizes that will meet requirements, try to choose a “middle-of-the-road” option that best anticipates future growth requirements. If no combination meets the requirements, the requirements have to change!

IP Subnetting Step #3: Determining The Custom Subnet Mask

Once we have decided how many bits to use for the subnet ID and how many to leave for the host ID, we can determine the [custom subnet mask](#) for our network. Now, don't go running for cover on me. ☺ A lot of people's eyes glaze over at mention of the subnet mask, but it's really quite simple to figure out once we have done our homework in making the design decision we did in [Step #2](#). In fact, there are two ways of doing this; one is less work than the other, but they're both quite easy. I was going to call them the “hard” way and the “easy” way, but instead, I'll call them “easy” and “easier”.

Calculating The Custom Subnet Mask

Let's start with the “easy” method, in which we determine the subnet mask in binary form from the information we already have about our network, and then convert the mask to decimal. To refresh your memory and guide the process, remember this: the [subnet mask](#) is a 32-bit binary number where a 1 represents each bit that is part of the network ID or subnet ID, and a 0 represents each bit of the host ID.

Class C Custom Subnet Mask Calculation Example

Refer back to the Class C example in the previous topic. We decided to use 3 bits for the subnet ID, leaving 5 bits for the host ID. Here are the steps we will follow to determine the custom subnet mask for this network (illustrated in [Figure 76](#)):

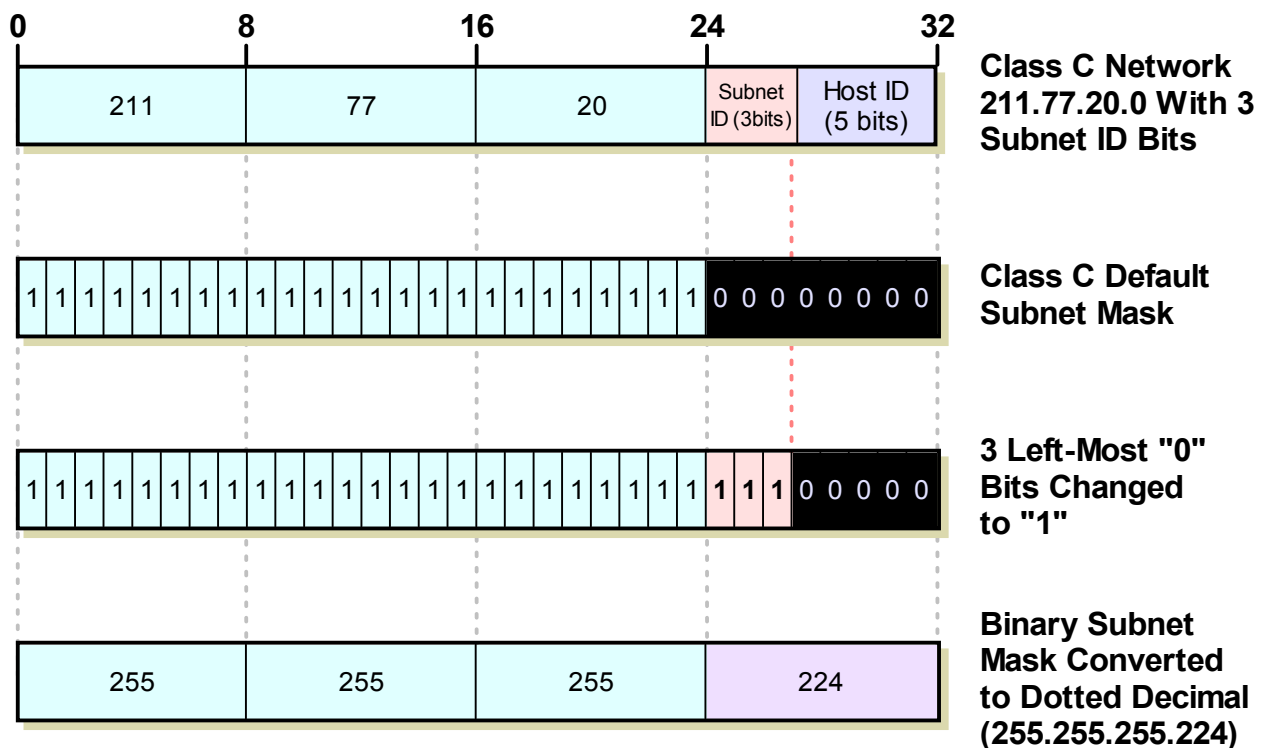

Figure 76: Determining The Custom Subnet Mask for A Class C Network

- Determine Default Subnet Mask:** Each of Classes A, B and C has a [default subnet mask](#), which is the subnet mask for the network prior to subnetting. It has a 1 for each network ID bit and a 0 for each host ID bit. For Class C, the subnet mask is 255.255.255.0. In binary, this is:

```
11111111 11111111 11111111 00000000
```
- Change Left-Most Zeroes To Ones For Subnet Bits:** We have decided to use 3 bits for the subnet ID. The subnet mask has to have a 1 for each of the network ID or subnet ID bits. The network ID bits are already 1 from the default subnet mask, so, we change the 3 *left-most* 0 bits in the default subnet mask from a 0 to 1, shown highlighted below. This results in the following custom subnet mask for our network:

```
11111111 11111111 11111111 11100000
```
- Convert Subnet Mask To Dotted Decimal Notation:** We take each of the octets in the subnet mask and convert it to decimal. The result is our custom subnet mask in the form we usually see it: 255.255.255.224.
- Express Subnet Mask In "Slash Notation":** Alternately, we can express the subnet mask in "slash notation". This is just a slash followed by the number of ones in the subnet mask. 255.255.255.224 is equivalent to "/27".

Class B Custom Subnet Mask Calculation Example

Now, let's do the same example with our Class B network (166.113.0.0) with 5 bits for the subnet ID (with a bit less narration this time; see [Figure 77](#)):

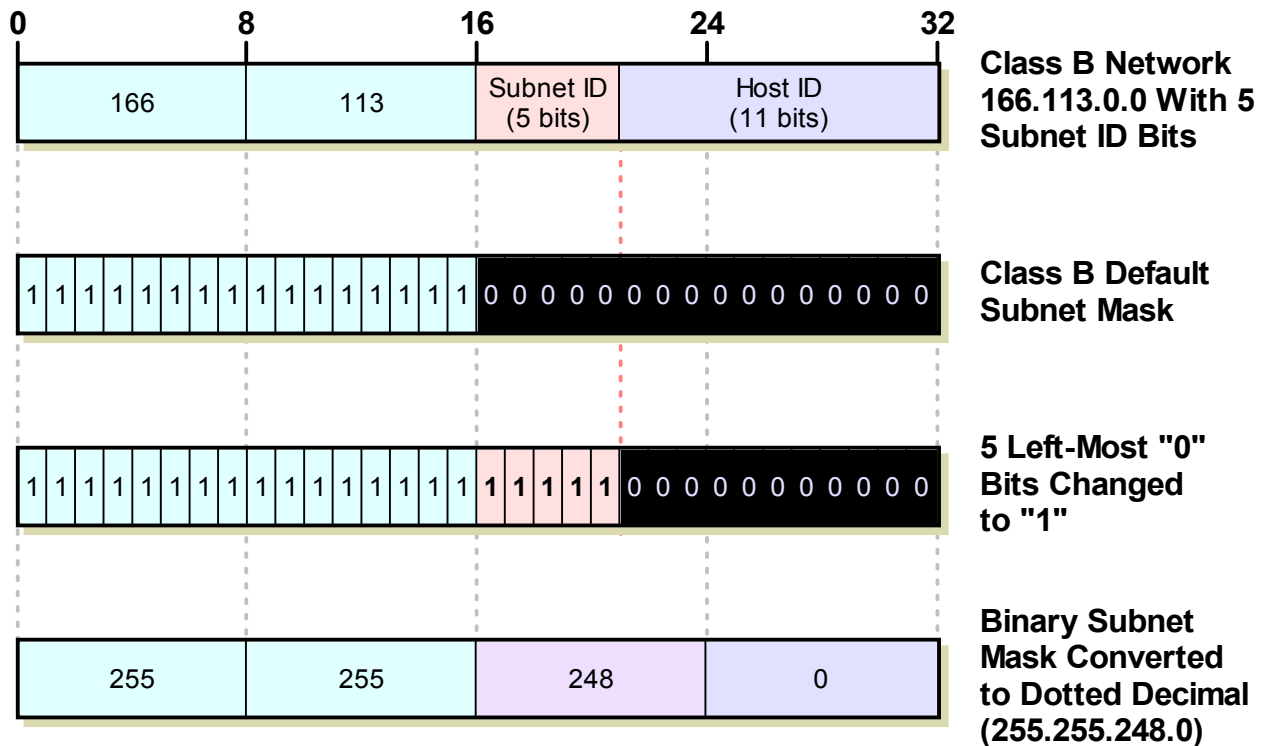

Figure 77: Determining The Custom Subnet Mask for A Class B Network

- Determine Default Subnet Mask:** For Class B, the subnet mask is 255.255.0.0. In binary, this is:

```
11111111 11111111 00000000 00000000
```
- Change Left-Most Zeroes To Ones For Subnet Bits:** We have decided to use 5 bits for the subnet ID, so, we change the 5 left-most 0 bits from a 0 to 1, shown highlighted below, to give us our binary custom subnet mask:

```
11111111 11111111 11110000 00000000
```
- Convert Subnet Mask To Dotted Decimal Notation:** We take each of the octets in the subnet mask and convert it to decimal, to give us a custom subnet mask of 255.255.248.0
- Express Subnet Mask In "Slash Notation":** We can express the subnet mask 255.255.248.0 as "/21", since it is 21 ones followed by 11 zeroes. In other words, its prefix length is 21.

Determining The Custom Subnet Mask Using Subnetting Tables

Now, what could be easier than that? Well, you could simply [refer to the subnetting summary tables](#). Find the table for the appropriate class, and then find the row that you selected in the previous step that matches the number of subnet ID bits you want to use. You can see the matching subnet mask right there.

(Hey, it's good to know how to do it yourself! You may not always have tables to refer to!)

IP Subnetting Step #4: Determining Subnet Identifiers and Subnet Addresses

The network ID assigned to our network applies to the entire network. This includes all subnets and all hosts in all subnets. Each subnet, however, needs to be identified with a unique *subnet identifier* or *subnet ID*, so it can be differentiated from the other subnets in the network. This is of course the purpose of the subnet ID bits that we took from the host ID bits [in subnetting](#). After we have identified each subnet we need to determine the address of each subnet, so we can use this in assigning hosts specific IP addresses.

This is another step in subnetting that is not really hard to understand or do. The key to understanding how to determine [subnet IDs and subnet addresses](#) is to always work in binary form, and then convert to decimal later. We will also look at a “shortcut” for determining addresses in decimal directly, which is faster but less conceptually simple.

Let's go directly to our examples to see how subnet IDs and addresses are determined. We number the subnets starting with 0, and then going to 1, 2, 3 and so on, up to the highest subnet ID that we need.



Note: I assume in this description that we will be using the all-zeroes and all-ones subnet numbers. In the original RFC 950 subnetting system, those two subnets are not used, which changes most of the calculations below. [See here for an explanation.](#)

We determine the subnet IDs and addresses as follows

1. **Subnet ID:** This is just the subnet number, and can be expressed in either binary or decimal form.
2. **Subnet Address:** This is the address formed by taking the address of the network as a whole, and substituting the (binary) subnet ID in for the subnet ID bits. We need to do this in binary, but only for the octets where there are subnet ID bits; the ones where there are only network ID bits or only host ID bits are left alone.

Seem complicated? Let's go back to our examples and we'll see that it's really not.

Class C Subnet ID and Address Determination Example

Recall our Class C network, 211.77.20.0. The network address in binary is:

11010011 01001101 00010100 00000000

We are subnetting using 3 bits for the subnet ID, leaving 5 bits for the host ID. Now let's see the network address with the subnet bits in bold:

11010011 01001101 00010100 **000**00000

These are the bits we substitute with the subnet ID for each subnet. Notice that since the first three octets contain network ID bits, and the network ID is the same for every subnet, they never change. We don't even really need to look at them in binary form, though for clarity we will do so.

Here's how we determine the subnet IDs and addresses, again, starting with 0 (see [Figure 78](#)):

0. Subnet #0 has a subnet ID of 0, or 000 in binary. To find the address, we start with the network address in binary, and substitute "000" for the subnet ID bits. Well gee, those bits are already all zero! What this means is that the address for subnet #0 is the same as the address for the network as a whole: 211.77.20.0.

This is always the case: subnet #0 always has the same address as the network.

1. Subnet #1 has a subnet ID of 1 in decimal or 001 in binary. To find the address we substitute "001" for the subnet ID bits, to yield the following:

11010011 01001101 00010100 **001**00000

Converting to decimal, we get 211.77.20.32.

2. Subnet #2 has a subnet ID of 2, or 010 in binary. To find its address we substitute "010" for the subnet ID bits, to give:

11010011 01001101 00010100 **010**00000

Which is 211.77.20.64 in binary.

3. Subnet #3 has a subnet ID of 011. As we can see the first three octets of the address are always 211.77.20. The last octet here is "**011**00000", which is 96 in decimal, so the whole address is 211.77.20.96.

Starting to see a pattern here? Yep, the address of any subnet can be found by adding 32 to the last octet of the previous subnet. This pattern occurs for all subnetting choices; the increment depends on how many bits we are using for the subnet ID. Here, the increment is 32, which is 2^5 ; 5 is the number of host ID bits left after we took 3 subnet ID bits.

4. Subnet #4 is 100, address is 211.77.20.128.
5. Subnet #5 is 101, address is 211.77.20.160.
6. Subnet #6 is 110, address is 211.77.20.192.
7. Subnet #7 is 111, address is 211.77.20.224.

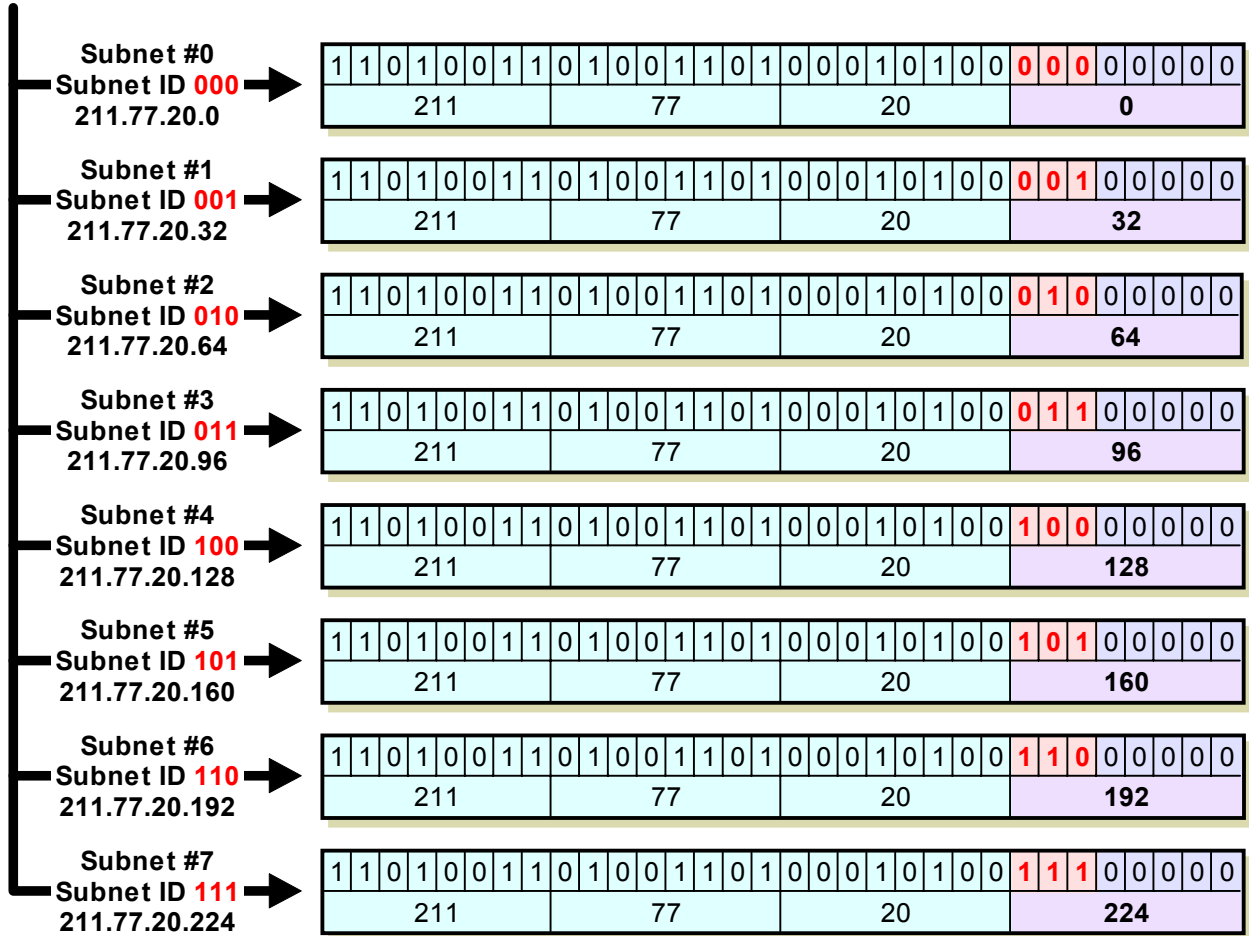
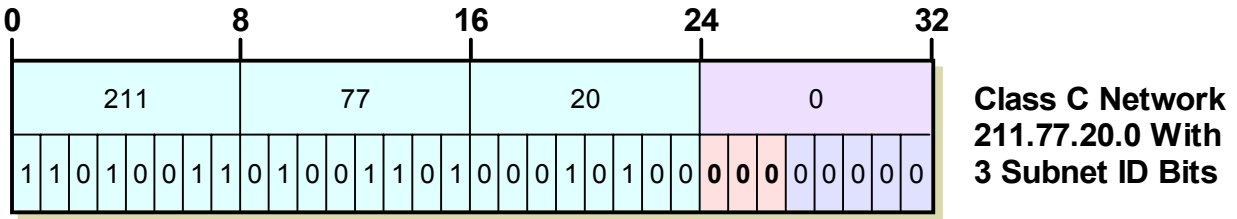

Figure 78: Determining Subnet Addresses For A Class C Network

This diagram shows each of the 8 possible subnets created when we use 3 bits for the subnet ID in a Class C network. The binary subnet ID is simply substituted for the subnet bits, and the resulting 32-bit number converted to dotted decimal form.



Key Concept: The subnet addresses in a subnetted network are always evenly spaced numerically, with the spacing depending on the number of subnet ID bits.

We only needed seven subnets in our example, #0 through #6. Subnet #7 would be a spare. Notice that the last subnet has the same last octet as the subnet mask for our network? That's because we substituted "111" for the subnet ID bits, [just as we did when we calculated the subnet mask](#).

Class B Subnet ID and Address Determination Example

Let's look at our other example now, Class B network 166.113.0.0. In binary this is:

0100110 01110001 00000000 00000000

We are using 5 bits for the subnet ID, leaving 11 host ID bits. The network address with the subnet ID bits highlighted is:

0100110 01110001 **00000**000 00000000

Here, only the third octet will ever change for the different subnets. The first two will always be "166.113" and the last octet will always be zero. There are 32 possible subnets; I'll list the first few so you can see the pattern (refer to [Figure 79](#) as well):

0. Subnet #0 has a subnet ID of 00000. This means the address will be 166.113.0.0, the network address, as we would expect.
1. Subnet #1 has a subnet ID of 00001. The address becomes:

10100110 01110001 **00001**000 00000000

This is 116.113.8.0 in decimal.

2. Subnet #2 has a subnet ID of 00010, giving an address of 116.113.**00010**000.0 or 116.113.16.0.
3. Subnet #3 has a subnet ID of 00011 and a subnet address of 116.113.24.0.

Again, the pattern here is obvious: you add 8 to the third octet to get successive addresses. The last subnet here is #31, which has a subnet address of 116.113.248.0, which has the same third and fourth octets as our subnet mask of 255.255.248.0.

Using Subnet Address Formulas to Calculate Subnet Addresses

Since the subnet addresses form a pattern, and the pattern depends on the number of subnet ID bits, it is possible to express the subnet addresses using a single formula for each subnetting option. I have shown these formulas for each of Classes A, B and C in the [subnetting summary tables](#). The formulas can be used to directly calculate the address of subnet #N, where N is numbered from 0 up to one less than the total number of subnets, as we have done above.

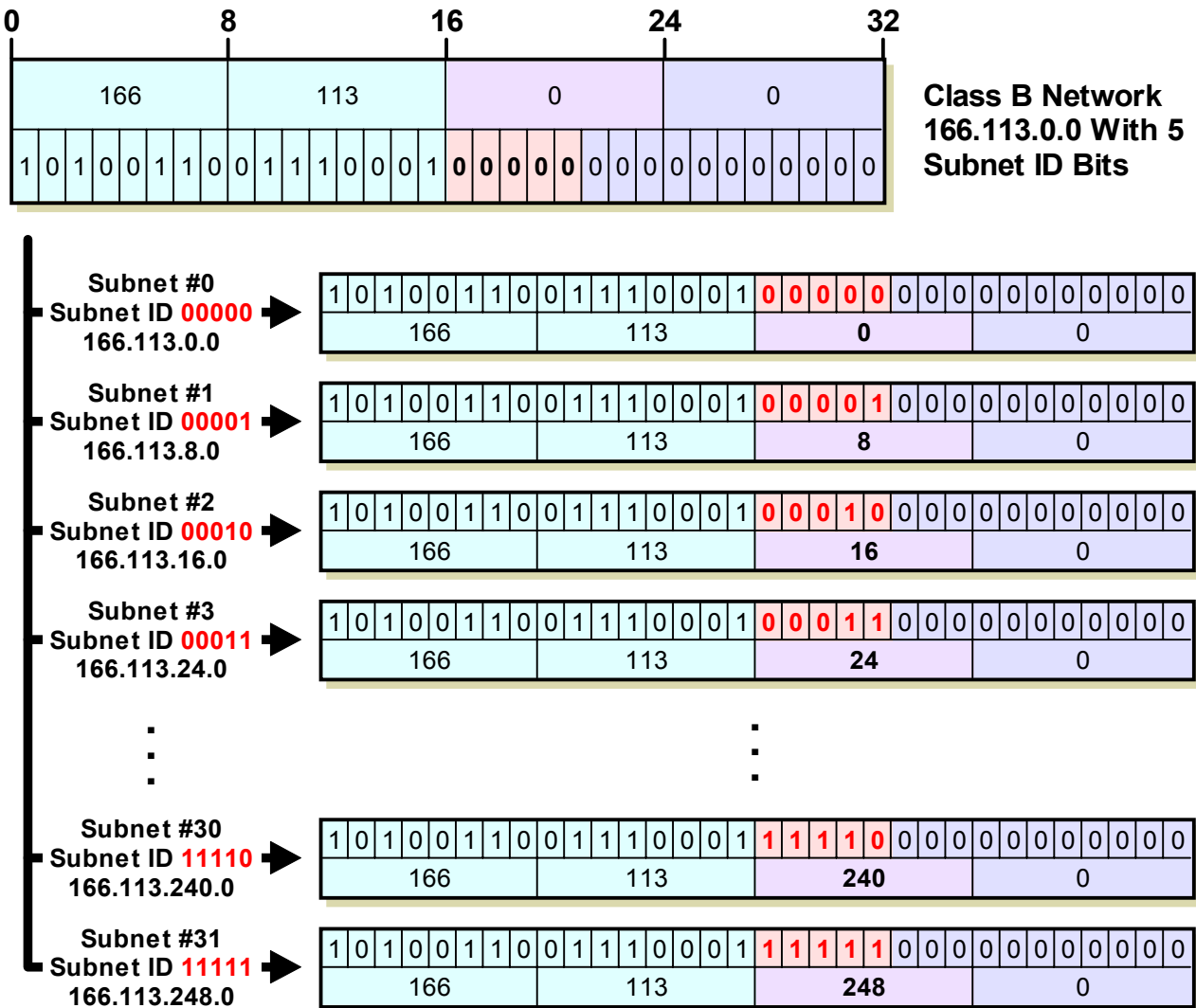

Figure 79: Determining Subnet Addresses For A Class B Network

This is the same as [Figure 78](#), but for a Class B network with 5 subnet ID bits (I have not shown all 32 subnets, for obvious reasons!)

Basic Subnet Formula Calculations

In these formulas, the network ID bits are shown as “x.”, or “x.y.” or “x.y.z.” for the three classes. This just means that the subnet addresses have as those octets whatever the numbers are in those octets for the network address. In our examples, “x.y” would be “166.113” for our Class B network, and “x.y.z” would be “211.77.20” for our Class C.

When the number of subnet bits is 8 or less, the formula is relatively simple, and a calculation is done for only one octet, as a multiplication of N, such as “N*4” or “N*32”. This is usually the case, since the number of subnets is usually less than 256, and it's the case with both of our examples.

In our Class C network with 3 subnet ID bits, the formula from the table is “x.y.z.N*32”. For this network, all subnets are of the form “211.77.20.N*32”, with N going from 0 to 7. So, subnet #5 is 211.77.20.(5*32), which is 211.77.20.160, as we saw before. Similarly, in our Class B network with 5 subnet ID bits, the formula is x.y.N*8.0. In this case “x.y” is 166.113. Subnet #26 would have the address 166.113.(26*8).0, or 166.113.208.0.

This is pretty simple stuff, and make the formulas a good short-cut for quickly determining subnet addresses, especially when there are many subnets. They can also be used in a spreadsheet. The only place that using the formulas requires a bit of care is when the number of subnet bits is 9 or more. This means the subnet identifier crosses an octet boundary, and this causes the formula to become more complex. So consider the rest of this topic optional, and [skip it](#) if you don't want to complicate your brain. ☺

Subnet Formula Calculations With More Than 8 Subnet Bits

When the number of subnet bits is greater than 8, some of the octets are of the form “N divided by an integer”, such as “N/8”. This is an *integer division*, which means “divide N by 8, keep the integer part and drop the fractional part or *remainder*”. Other octets are calculated based on the *modulo* of N, shown as “N%8”. This is the exact opposite: it means, “divide N by 8, drop the integer and keep the remainder”. For example, 33/5 in integer math is 6 (6 with a remainder of 3, drop the remainder, or alternately, 6.6, drop the fraction). 33%5 is 3 (6 with a remainder of 3, drop the 6, keep the remainder).

Let's take as an example our Class B network and suppose that for some strange reason we decided to use 10 bits for the subnet ID instead of 5. In this case, the formula is “x.y.N/4.(N%4)*64”. Subnet #23 in this case would have the address “166.113.23/4.(23%4)*64. The 23/4 becomes just 5 (the fractional.75 is dropped). 23 modulo 4 is 3, which is multiplied by 64 to get 192. So the subnet address is “166.113.5.192”. Subnet #709 would be “166.113.709/4.(709%4)*64, which is 166.113.177.64.

Subnet Formula Calculations With More Than 16 Subnet Bits

Okay, now for the real fun. If you subnet a Class A address using more than 16 bits for the subnet ID, you are crossing *two* octet boundaries, and the formulas become very ... interesting, involving both integer division *and* modulo. Suppose we were in charge of Class A address 21.0.0.0 and choose to subnet it. However, we sat down to do this after having had a few stiff ones at the office holiday party, so our judgment is a bit impaired. We decide that it would be a great idea to choose 21 bits for our subnet ID, since we like the number 21. This gives us a couple million subnets.

The formula for subnet addresses in this case, is “x.N/8192.(N/32)%256.(N%32)*8”. Yikes. Well, this is a bit involved—so much so that it might be easier to just take a subnet number and do it in binary, the long way. But let's take an example and see how it works, for, say, subnet #987654. The first octet is of course 21. The second octet is 987654/8192, integer division. This is 120. The third octet is (987654/32)%256. The result of the division is 30864 (we drop the fraction). Then, we take 30864%256, which yields a remainder of 144. The fourth octet is (987654%32)*8. This is 6*8 or 48. So subnet address #987654 is 21.120.144.48.

(Don't drink and drive. Don't drink and subnet either. ☺)

IP Subnetting Step #5: Determining Host Addresses For Each Subnet

Once we know the addresses of each of the subnets in our network, we use these addresses as the basis for assigning IP addresses to the individual hosts in each subnet. We start by associating a subnet base address with each physical network (since at least in theory, our subnets correspond to our physical networks). We then sequentially assign hosts particular IP addresses within the subnet (or in a different manner, if we prefer!)

Determining host addresses is really quite simple, once we know the subnet address. All we do is substitute the numbers 1, 2, 3... and so on for the host ID bits in the subnet address. We must do this in binary of course, and then convert the address to decimal form. Again, we can do some “short-cutting” once the rather obvious pattern of how to assign addresses emerges. We'll look at those later in the topic.

Class C Host Address Determination Example

Let's start with our Class C example again, 211.77.20.0, which we divided into 8 subnets using 3 subnet bits. Here's how the address appears with the subnet bits shown highlighted, and the host ID bits shown highlighted and underlined.:

11010011 01001101 00010100 **00000000**

The first subnet is subnet #0, which has all zeroes for those subnet bits, and thus the same address as the network as a whole: 211.77.20.0. We substitute the numbers 1, 2, 3 and so on for the underlined bits to get the host IDs. (Remember that we don't start with 0 here because for the host ID, the all-zero and all-one binary patterns have special meaning). So it goes like this:

1. The first host address has the number 1 for the host ID, or “00001” in binary. So, it is:

11010011 01001101 00010100 **00000001**

In decimal, this is 211.77.20.1.

2. The second host address has the number 2 for the host ID, or “00010” in binary. Its binary value is:

11010011 01001101 00010100 **00000010**

In decimal, this is 211.77.20.2

I'm sure you get the picture already; the third host will be 211.77.20.3, the fourth 211.77.20.4 and so on. There is a maximum of 30 hosts in each subnet, as we saw before. So, the last host in this subnet will be found by substituting 30 (11110 in binary) for the host ID bits, resulting in a decimal address of 211.77.20.30.

We can do the same thing for each of the other subnets; the only thing that changes is the values in the subnet ID bits. Let's take for example, subnet #6. It has "110" for the subnet bits instead of "000". So, its subnet base address is 211.77.20.192, or:

11010011 01001101 00010100 11000000

We assign hosts to this subnet by substituting 00001, then 00010, then 00011 for the host ID bits as before:

1. The first host address is:

11010011 01001101 00010100 11000001

Or 211.77.20.193.

2. The second host address is:

11010011 01001101 00010100 11000010

Or 211.77.20.194.

And so on, all the way up to the last host in the subnet, which is 211.77.20.222. [Figure 80](#) shows graphically how subnet and host addresses are calculated for this sample network.

One more address we may wish to calculate is the broadcast address for the subnet. This of course is one of the [special cases](#), found by substituting all ones for the host ID. For subnet #0, this would be 211.77.20.31. For subnet #6, it would be 211.77.20.223. That's pretty much all there is to it.

Class B Host Address Determination Example

We can do the same thing for our Class B network, naturally. The address of that network is 166.113.0.0. Now, say we want to define the hosts that go in subnet #13. We substitute 13 in binary (01101) for the subnet ID bits, to get the following subnet address, shown with the subnet ID bits highlighted and the host ID bits highlighted and underlined:

10100110 01110001 01101000 00000000

This is the subnet address 166.113.104.0. Now, we have 11 bits of host ID, so we can have a maximum of 2,046 hosts. The first is found by substituting "000 00000001" for the host ID bits", to give an address of 166.113.104.1. The second host is 166.113.104.2, and so on. The last is found by substituting "111 1111110", to give an address of 166.113.111.254. Note that since the host ID bits extend over two octets, two octets change as we increment the host ID, unlike our Class C example. The broadcast address is 166.113.111.255.



Key Concept: In a subnetted network, the address of host #H within subnet number #S is found by plugging in the binary value of *S* for the network's subnet ID bits, and the binary value of *H* for subnet's host ID bits.

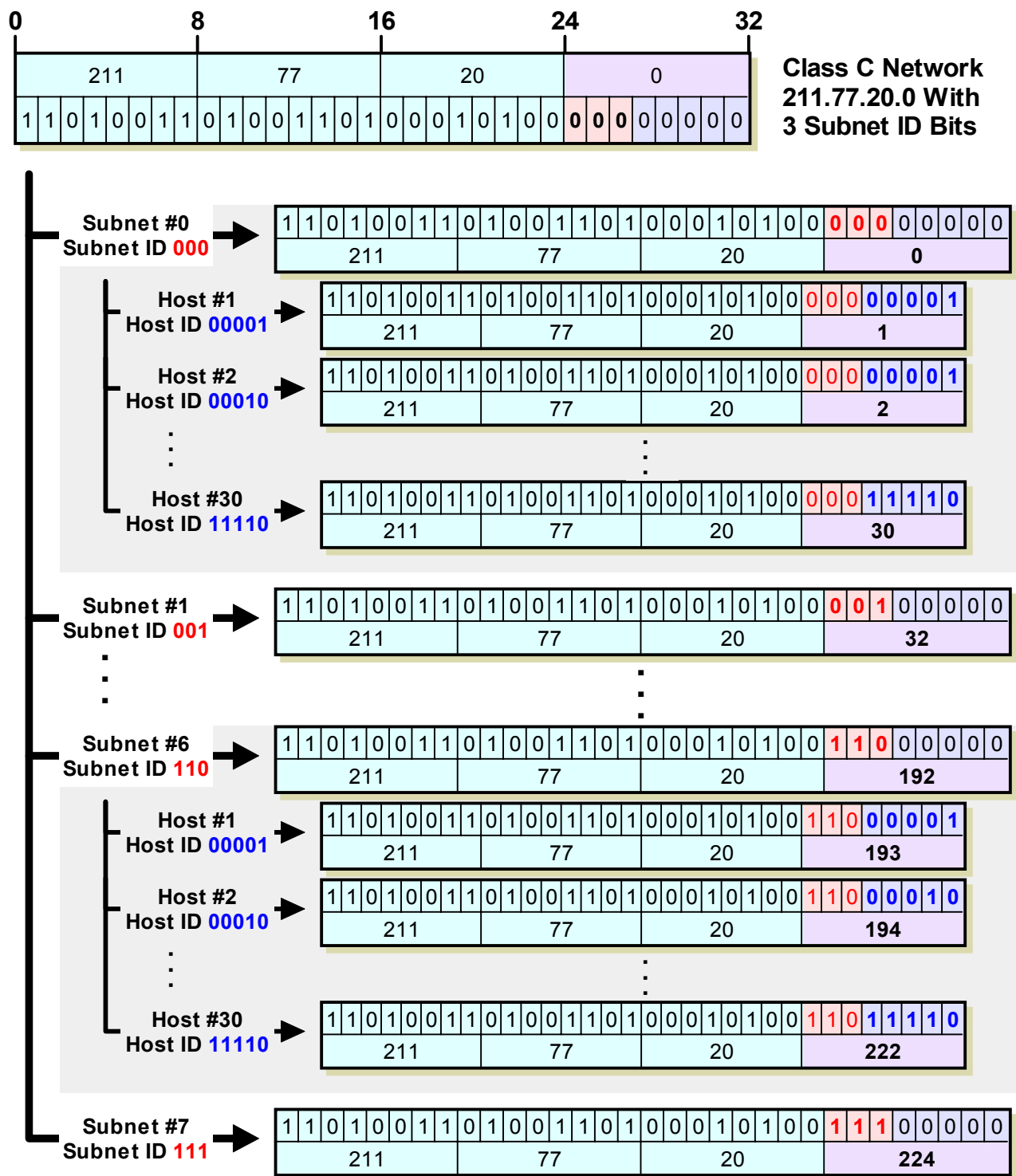

Figure 80: Determining Host Addresses For A Class C Network

This diagram shows how both subnet addresses and host addresses are determined in a two-step process. The subnet addresses are found by substituting subnet ID values (shown in red) for the subnet ID bits of the network. Then, for any given subnet address, we can determine a host address by substituting a host number (shown in blue) for the host ID bits within that subnet. So, for example, host #2 in subnet #6 has “110” for the subnet ID and “00010” for the host ID, resulting in a final octet value of “11000010” or 194.

"Shortcuts" For Quickly Computing Host Addresses

As you can see, defining the host IDs is really quite straight-forward. If you can substitute bits and convert to decimal, you have all you need to know. You can also see that as was the case with defining the subnet addresses, there are patterns that you can use in defining host IDs and understanding how they work. These generally define ways that we can more quickly determine certain host addresses by working directly in decimal instead of bothering with binary substitutions. This is a bit more complex conceptually, so only proceed if you are feeling a bit brave.

The following are some of the "shortcuts" you can use in determining host IP addresses in a subnet environment:

- ☉ **First Host Address:** *The first host address is always the subnet address with the last octet incremented by 1.* So, in our class C example, subnet #3's base address is 211.77.20.96. The first host address in subnet #3 is thus 211.77.20.97.
- ☉ **Subsequent Host Addresses:** After you find the first host address, to get the next one you just add one to the last octet of the previous address. If this makes the last octet 256 (which can happen only if there are more than 8 host ID bits) you "wrap around" this to zero and increment the third octet.
- ☉ **Directly Calculating Host Addresses:** If the number of host ID bits is 8 or less, you can find host #N's address by adding "N" to the last octet's decimal value. For example, in our class C example, subnet #3's base address is 211.77.20.96. Therefore, host #23 in this subnet has an address of 211.77.20.119.

If there are more than 8 bits in the host ID, this only works for the first 255 hosts, after which you have to "wrap around" and increase the value of the third octet. Consider again subnet #13 in our Class B example, which has a base address of 166.113.104.0. Host #214 on this subnet has address 166.113.104.0, but host #314 isn't 166.113.104.314. It is 166.113.105.58 (host #255 is 166.113.104.255, then host #256 is 166.113.105.0, and we count up 58 more (314-256) to get to #314, 166.113.105.58).

- ☉ **Range Of Host Addresses:** The range of hosts for any subnet is determined as follows:
 - ☉ **First Address:** Base address of subnet with last octet incremented by one.
 - ☉ **Last Address:** Base address of *next subnet after this one*, less two in the last octet (which may require changing a "0" in the last octet to "254" and reducing the value of the third octet by 1).

For example, consider subnet #17 in our Class B example. Its subnet address is 166.113.136.0. The address of subnet #18 is 166.113.144.0. So, the range of hosts for subnet #17 is 166.113.136.1 to 166.113.143.254.

- ☉ **Broadcast Address:** *The broadcast address for a subnet is always one less than the base address of the subsequent subnet.* Or alternately, one more than the last "real" host address of the subnet. So, for subnet #17 in our Class B example, the broadcast address is 166.113.143.255.

Did I just confuse you? Well, remember, these are shortcuts and sometimes when you take a shortcut you get lost. ☺ Just kidding, it's really not that hard once you play around with it a bit.

In closing, remember the following quick summary when working with IP addresses in a subnet environment:

1. The network ID is the same for all hosts in all subnets, and all subnets in the network.
2. The subnet ID is the same for all hosts in each subnet, but unique to each subnet in the network.
3. The host ID is unique within each subnet. Each subnet has the same set of host IDs.
4. Subnetting is fun!



IP Classless Addressing: Classless Inter-Domain Routing (CIDR) / "Supernetting"

As the early Internet began to grow dramatically, [three main problems arose with the original "classful" addressing scheme](#). These difficulties were addressed partially through [subnet addressing](#), which provides more flexibility for the administrators of individual networks on an internet. Subnetting, however, doesn't really tackle the problems in general terms. Some of these issues remain due to the use of classes even with subnets.

While development began on [IP version 6](#) and its [roomy 128-bit addressing system](#) in the mid-1990s, it was recognized that it would take many years before widespread deployment of IPv6 would be possible. In order to extend the life of IP version 4 until the newer IP version 6 could be completed, it was necessary to take a new approach to addressing IPv4 devices. This new system calls for eliminating the notion of address classes entirely, creating a new *classless addressing* scheme sometimes called *Classless Inter-Domain Routing (CIDR)*.

In this section I describe modern classless IP addressing. I begin with an overview of the concepts behind classless addressing and the idea behind "supernetting", including why it was created and what its advantages and disadvantages are. I then define CIDR and describe how the system works in more detail, including the notation used for address blocks. I list each of the CIDR address block sizes and show how they relate to the older class A, B and C networks. I conclude with an example of CIDR addressing, which is similar to the practical subnetting section prior to this one, but focused on CIDR and a bit more condensed.



Background Information: Classless IP addressing represents the latest evolution of IP addressing, following on the heels of subnetting and the original "classful" addressing system described in preceding sections. Understanding classless IP addressing and routing requires at least some familiarity with these older IP addressing methods. If you have come to this section without reading the preceding sections on ["classful" addressing](#) and [subnetting](#), I strongly advise reviewing them first. If you understand subnetting but aren't familiar with how Variable Length Subnet Masking (VLSM) works, reading [the topic on VLSM](#) is a good idea, since CIDR is similar to VLSM in many ways.

IP Classless Addressing and "Supernetting" Overview, Motivation, Advantages and Disadvantages

[Subnet addressing](#) was an important development in the evolution of IP addressing, because it solved some important issues with the conventional, two-level class-based addressing scheme. Subnetting's contribution to ease in IP addressing was allowing each network to have its own two-level hierarchy, giving the administrator of each network the equivalent of an "internet within the Internet".

When we looked at [the advantages of subnetting](#), we saw that one was that subnetting was local within each organization, and “invisible” to other organizations. This is an advantage in that it lets each organization tailor its network without other groups having to worry about the details of how this is done. Unfortunately, this “invisibility” also represents a key **disadvantage** of subnetted “classful” addressing: it cannot correct the fundamental inefficiencies associated with that type of addressing, because organizations are still assigned address blocks based on classes.

The Main Problem With “Classful” Addressing

A key weakness of regular subnetting is low “granularity”. A Class B address block contains a very large number of addresses (65,534) but a Class C block has only a relatively small number (254). There are many thousands of “medium-sized” organizations who need more than 254 IP addresses, but a small percentage of these need 65,534 or anything even close to it. (The lack of a good match to a medium-sized organization with 5,000 hosts is illustrated in [Figure 64](#).) When setting up their networks, these companies and groups would tend to request Class B address blocks and not Class C blocks because they need more than 254, without considering how many of the 65,000-odd addresses they really would use.

Now, due to how the classes of the older system were designed, there are over 2 million Class C address blocks, but only 16,384 Class Bs. While 16,384 seems like a lot at first glance, there are millions of organizations and corporations around the world. Class B allocations were being consumed at a rapid pace, while the smaller Class C networks were relatively unused.

The [folks handing out Internet addresses](#) needed a way to better utilize the address space so it would not run out before the transition to IP version 6. Subnetting didn't help a great deal with this problem. Why? Because it only works **within** the “classful” address blocks. If an organization needing 2,000 IP addresses requests a Class B block, they could use subnetting to more efficiently manage their block. However, subnetting could do nothing about the fact that this organization would never use over 62,000 of the addresses in its block—about 97% of their allocated address space.

The only solution to this would be to convince—or at worst case, force—companies to use many smaller Class C blocks instead of “wasting” the bulk of a Class B assignment. Many organizations resisted this due to the complexity involved, and this caused the other main problem that subnetting didn't correct: the growth of Internet routing tables. Replacing one Class B network with 10 Class Cs means ten times as many entries for routers to keep track of.

A Better Solution: Eliminate Address Classes

It was clear that as long as there were only three sizes of networks, the allocation efficiency problem could never be properly rectified. The solution was to get rid of the classes completely, in favor of a *classless* allocation scheme. This system would solve both of the main problems with “classful” addressing: inefficient address space use, and the exponential growth of routing tables.

This system was developed in the early 1990s and formalized in 1993 in RFCs 1517, 1518, 1519 and 1520. The technology was called *Classless Inter-Domain Routing (CIDR)*. Despite this name, the scheme deals with both addressing and routing matters, since they are inextricably linked.

The idea behind CIDR is to adapt the concept of subnetting a single network to the entire internet. In essence, then, classless addressing means that instead of breaking a particular network into subnets, we can aggregate networks into larger “supernets”. CIDR is sometimes called *supernetting* for this reason: it applies the principles of subnetting to larger networks. It is this aggregation of networks into supernets that allowed CIDR to resolve the problem of growing Internet routing tables.

Of course, if we are going to apply subnetting concepts to the entire internet, we need to be able to have subnets of different sizes. After all, that's one of our primary goals in eliminating the classes. So, more accurately, CIDR is an internet-wide application of not regular one-level subnetting, but of [Variable Length Subnet Masking \(VLSM\)](#). Just as VLSM lets us split a network as many times as we want to create subnets, “sub-subnets” and “sub-sub-subnets”, CIDR lets us do this with the entire Internet, as many times as needed.



Key Concept: Classless Inter-Domain Routing (CIDR) is a system of IP addressing and routing that solves the many problems of “classful” addressing by eliminating fixed address classes in favor of a flexible, multiple-level, hierarchical structure of networks of varying size.

The Many Benefits of Classless Addressing and Routing

CIDR provides numerous advantages over the “classful” addressing scheme, whether or not subnetting is used:

- ☉ **Efficient Address Space Allocation:** Instead of allocating addresses in fixed-size blocks of low granularity, under CIDR addresses are allocated in sizes of any binary multiple. So, a company that needs 5,000 addresses can be assigned a block of 8,190 instead of 65,534, as shown in [Figure 81](#). Or, to think of it another way, the equivalent of a single Class B network can be shared amongst 8 companies that each need 8,190 or fewer IP addresses.
- ☉ **Elimination of Class Imbalances:** There are no more class A, B and C networks, so there is no problem with some portions of the address space being widely used while others are neglected.
- ☉ **Efficient Routing Entries:** CIDR's multiple-level hierarchical structure allows a small number of routing entries to represent a large number of networks. Network descriptions can be “aggregated” and represented by a single entry. Since CIDR is hierarchical, the detail of lower-level, smaller networks can be hidden from routers that move traffic between large groups of networks. [This is discussed more completely in the section on IP routing issues.](#)

-
- ④ **No Separate Subnetting Method:** CIDR implements the concepts of subnetting within the internet itself. An organization can use the same method used on the Internet to subdivide its internal network into subnets of arbitrary complexity without needing a separate subnetting mechanism.

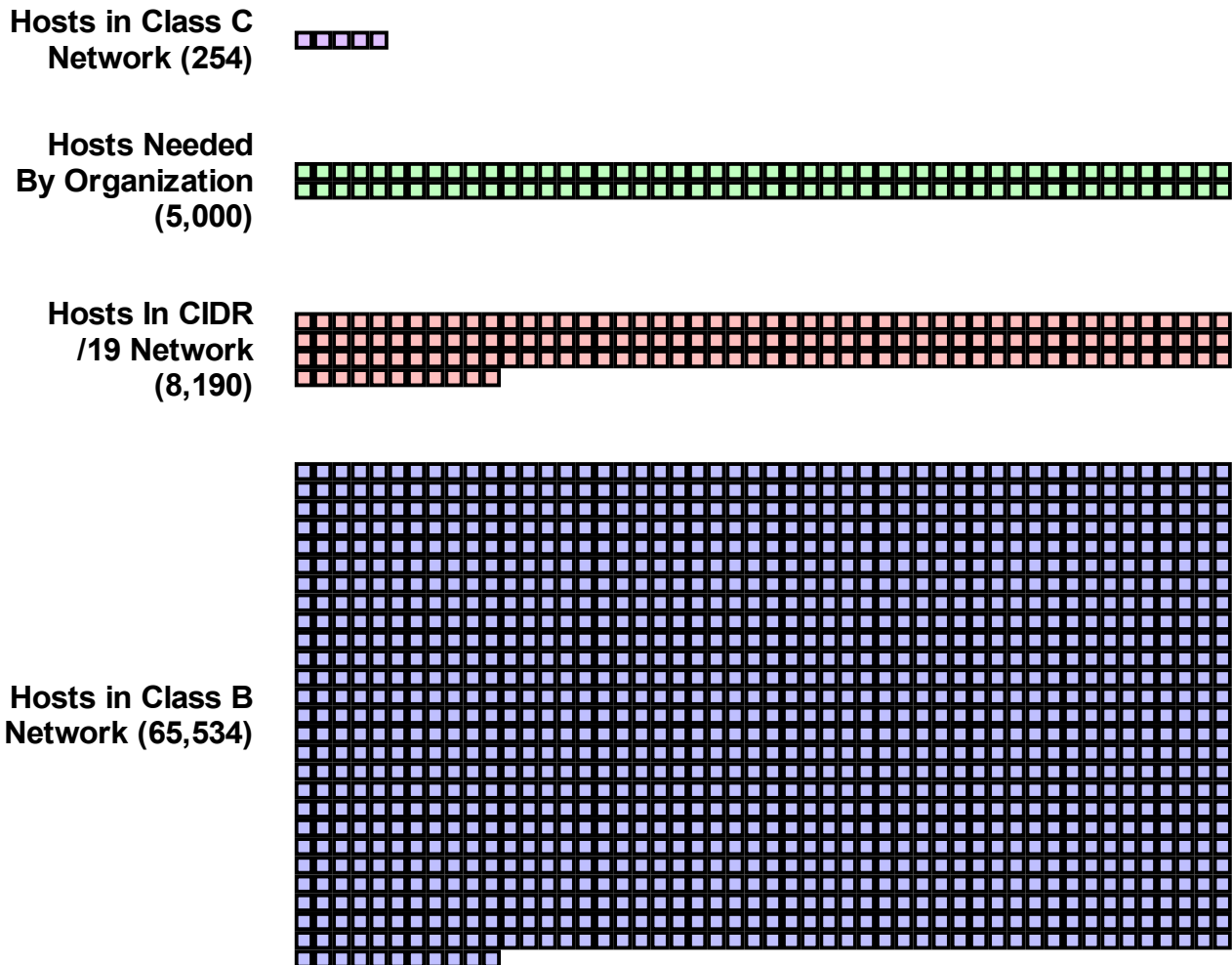

Figure 81: Classless Addressing (CIDR) Solves The “Granularity Problem”

Figure 64 illustrated the primary problem with “classful” addressing: the great distance between the size of Class B and Class C networks. CIDR solves this issue by allowing any number of bits to be used for the network ID. In the case of an organization with 5,000 hosts, a /19 network with 8,190 hosts can be assigned. This reduces the address space waste for such an organization by about 95%.

The Main Disadvantage of CIDR: Complexity

Since the main benefit of “classful” addressing was its simplicity, it's no surprise that the main drawback of CIDR is its greater complexity. One issue is that it is no longer possible to determine by looking at the first octet to determine how many bits of an IP address represent the network ID and how many the host ID. A bit more care needs to be used in setting up routers as well, to make sure that routing is accomplished correctly.

IP "Supernetting": Classless Inter-Domain Routing (CIDR) Hierarchical Addressing and Notation

When we first looked at IP addressing, we saw that IP addresses are designed to be [divided into a network identifier and host identifier](#). Then, when subnets were introduced, we “stole” bits from the host ID to create a subnet ID, giving the IP address a total of [three hierarchical levels](#). With [VLSM](#), we further subnetted the subnets, taking more bits from the host ID to give us a multiple-level hierarchy with “sub-subnets”, “sub-sub-subnets” and so forth.

In a classless environment, we completely change how we look at IP addresses, by applying VLSM concepts not just to one network, but to the entire Internet. In essence, the Internet becomes just one giant network that is “subnetted” into a number of large blocks. Some of these large blocks are then broken down into smaller blocks, which can in turn be broken down further. This breaking down can occur multiple times, allowing us to split the “pie” of Internet addresses into slices of many different sizes, to suit the needs of organizations.

As the name implies, classless addressing completely eliminates the prior notions of classes. There are no more Class A, B, C blocks that are divided by the first few bits of the address. Instead, under CIDR, all Internet blocks can be of arbitrary size. Instead of having all networks use 8 (Class A), 16 (Class B) or 24 (Class C) bits for the network ID, we can have large networks with, say, 13 bits for the network ID (leaving 19 bits for the host ID), or very small ones that use 28 bits for the network ID (only 4 bits for the host ID). The size of the network is still based on the binary power of the number of host ID bits, of course.

Recall that when we used subnetting, we had a problem: subnetting could be done by taking any number of available host ID bits, so how would devices know where the line was between the subnet ID and host ID? The same problem occurs under CIDR. There are no classes, so we can't tell anything by looking at the first few bits of an IP address. Since addresses can have the dividing point between host ID and network ID occur anywhere, we need additional information in order to interpret IP addresses properly. Under CIDR, of course, this impacts not only addresses within an organization but in the entire Internet, since there are no classes and each network can be a different size.

CIDR ("Slash") Notation

Just as subnetting required the use of a [subnet mask](#) to show which bits belong to the network ID or subnet ID and which to the host ID, CIDR uses a subnet mask to show where the line is drawn between host ID and network ID. However, for simplicity, under CIDR we don't usually work with 32-bit binary subnet masks. Instead, we use *slash notation*, more properly called *CIDR notation*. In this method, we show the size of the network, sometimes called the *prefix length*, by following an IP address by an integer that tells us how many bits are used for the network ID (prefix).



Key Concept: Since there are no address classes in CIDR, one cannot tell the size of the network ID of an address from the address alone. In CIDR, the length of the prefix (network ID) is indicated by placing it following a slash after the address. This is called *CIDR notation* or *slash notation*.

For example, consider the network specification 184.13.152.0/22. The “22” means this network has 22 bits for the network ID and 10 bits for the host ID. This is equivalent to specifying a network with an address of 184.13.152.0 and a subnet mask of 255.255.252.0, as you can see in [Figure 82](#). This sample network provides a total of 1,022 hosts (2^{10} minus 2). [The table in the following topic](#) shows all the different possible network sizes that can be configured under CIDR.

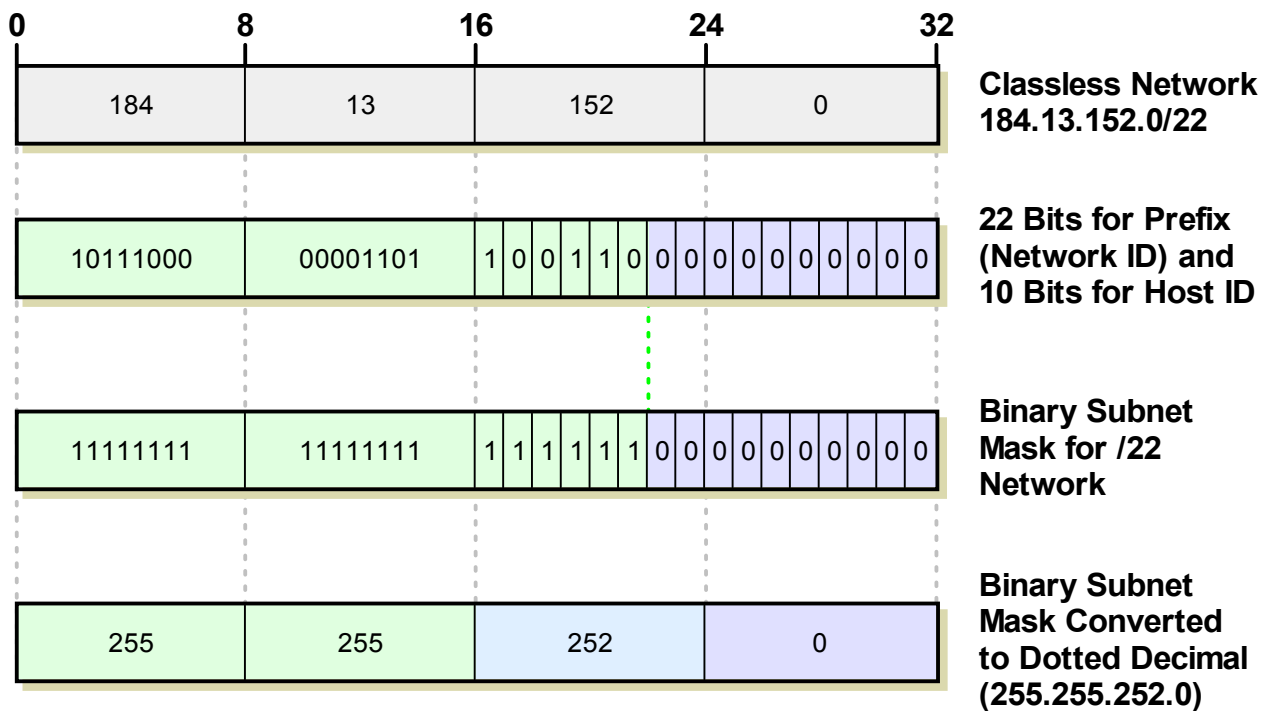

Figure 82: CIDR (“Slash”) Notation and Its Subnet Mask Equivalent

A classless network is normally specified in CIDR or “slash” notation, such as this example: 184.13.152.0/22. Here, the “/22” means the first 22 bits of the address are the network ID. The equivalent subnet mask can be calculated by creating a 32-bit number with 22 ones followed by 10 zeroes.



Note: You may recall my mentioning that under “classful” subnetting, [the bits used for the subnet ID did not need to be contiguous](#). Even though to avoid confusion this was rarely if ever used, non-contiguous subnet ID bits were possible. Under CIDR, the requirement for contiguous subnet ID bits has been made official—you could not use slash notation otherwise.

“Supernetting”: Subnetting the Internet

In theory, then, what CIDR does is provide the [central address-assignment authority](#) with the flexibility to hand out address blocks of different sizes to organizations based on their need. However, when CIDR was developed, a shift was made in the method by which public IP addresses were assigned. Having everyone in the world attempt to get addresses from one organization wasn’t the best method. It was necessary under the “classful” scheme because the hierarchy was only two levels deep: IANA handed out network IDs to everyone, who then assigned host IDs (or subnetted).

Under CIDR we have many hierarchical levels: we split big blocks into smaller blocks and then still-smaller blocks, and so on. It makes sense to manage blocks in a similar hierarchical manner as well. So, what happens is that IANA/ICANN divides addresses into large blocks, which it distributes to the four *regional Internet registries (RIRs)*: APNIC, ARIN, LACNIC and RIPE NCC. These then further divide the address blocks and distribute them to lower-level national Internet registries (NIRs), local Internet registries (LIRs) and/or individual organizations such as Internet Service Providers (ISPs). This is all explained in [the background topic on Internet authorities and registries](#).

ISPs can then divide these blocks into smaller ones that they allocate to their customers. These customers are sometimes smaller ISPs themselves, which repeat the process. They split their blocks into pieces of different sizes and allocate them to their customers, some of whom are even smaller ISPs and some of whom are “end users”. The number of times this can occur is limited only by how many addresses are in the original block.

It’s also worth noting that while CIDR is based on subnetting concepts, subnetting itself is not used in CIDR—or at least, not in the way it is used under “classful” addressing. There is no explicit subnetting using a subnet ID within CIDR: all IP addresses are interpreted only as having a network ID and a host ID. An organization does the equivalent of subnetting by dividing its own network into subnetworks using the same general method that ISPs do. This probably seems a bit confusing. [Later in this section I have provided a detailed example](#) of how hierarchical address block assignment and splitting works under CIDR.

Common Features of “Classful” and Classless Addressing

Note that there are a few aspects of addressing that were defined under the “classful” scheme that don’t change under CIDR:

-
- ☉ **Private Address Blocks:** Certain blocks of addresses are still reserved for private network addressing. These addresses are not directly routed on the Internet, but can be used in conjunction with [Network Address Translation \(NAT\)](#) to allow IP hosts without public addresses to access the Internet.
 - ☉ **Addresses With Special Meanings:** [The special meanings assigned to certain network ID and host ID patterns](#) are the same as before. This is also why we still must subtract two from the number of hosts in each network: for the all-zeroes case that refers to the network as a whole, and the all-ones address used for broadcast.
 - ☉ **Loopback Addresses:** The network 127.0.0.0 is still reserved for [loopback functionality](#). (In CIDR it is given the notation 127.0.0.0/8).

Finally, note that use of classless addressing requires hardware and software designed to handle it. If the hardware and software are still assuming that they are operating in a “classful” environment, they will not properly interpret addresses. Since CIDR has now been around for over a decade, this is usually not a problem with modern systems.

IP Classless Addressing Block Sizes and "Classful" Network Equivalents

Since CIDR allows us to divide IP addresses into network ID and host ID along any bit boundary, it permits the creation of dozens different sizes of networks. As with subnetting, the size of network is a [trade-off between the number of bits used for the network ID and the number used for the host ID](#). Unlike conventional subnetting, where a single choice is made for all subnets, CIDR allows many levels of hierarchical division of the Internet, so many sizes of networks exist simultaneously. Larger networks are created and subdivided into smaller ones, as we saw in the previous topic.

Since many people are used to looking at IP address blocks in terms of their “classful” sizes, it is common to express CIDR address blocks in terms of their “classful” equivalents. First of all, it should be simple at this point to see that a CIDR “/8” network is equal in size to a Class A network; a “/16” is equivalent to a Class B; a “/24” is equivalent to a Class C. This is of course because Class A networks use 8 bits for the network ID, Class Bs use 16, and Class Cs use 24. However, remember that these CIDR equivalents do not need to have any [particular ranges for their first octets](#) as in the “classful” scheme.

Each time we reduce the prefix length, we are defining a network about double the size of the one with the higher number, since we have increased the number of bits in the host ID by one. So, a “/15” network is equal in size to two “/16”s.

[Table 56](#) shows each of the possible theoretical ways to divide the 32 bits of an IP address into network ID and host ID bits under CIDR. For each, I have shown the number of hosts in each network, and the way a network of each size is represented in both slash notation and as a conventional subnet mask. I have also shown the equivalent number of Class A, Class B and Class C networks for each.

A few things to remember in looking at this table:

- Some of the entries shown are more theoretical than practical, and are included merely for completeness. This is particularly the case with the larger networks. For example, I doubt anyone ever actually works with a /1 or /2 size CIDR network; there would only be two of the former and four of the latter encompassing the entire IP address space! Most of the time you will be working with smaller networks, /16 and below.
- Under normal circumstances, you cannot have a /31 or /32 CIDR network since they would have zero valid host IDs. (There is a special case: /31 networks can be used for point-to-point links, where it is obvious who the intended recipient is of each transmission, and where broadcasts are not necessary. This is described in RFC 3021.)
- In the columns showing the number of equivalent Class A, B and C networks I have only shown numbers in the range of 1/256th to 256 for simplicity. Obviously, a /6 network, in addition to being equal in size to 4 Class A networks, also equals 1,024 Class Bs and 262,144 Class C networks, but few people would bother referring to a /6 as being 262,144 Class Cs.

Table 56: CIDR Address Blocks and “Classful” Address Equivalents (Page 1 of 2)

# of Bits For Network ID	# of Bits For Host ID	# of Hosts Per Network	Prefix Length in Slash Notation	Equivalent Subnet Mask	# of Equivalent “Classful” Addressing Networks		
					Class A	Class B	Class C
1	31	2,147,483,646	/1	128.0.0.0	128	—	—
2	30	1,073,741,822	/2	192.0.0.0	64	—	—
3	29	536,870,910	/3	224.0.0.0	32	—	—
4	28	268,435,454	/4	240.0.0.0	16	—	—
5	27	134,217,726	/5	248.0.0.0	8	—	—
6	26	67,108,862	/6	252.0.0.0	4	—	—
7	25	33,554,430	/7	254.0.0.0	2	—	—
8	24	16,777,214	/8	255.0.0.0	1	256	—
9	23	8,388,606	/9	255.128.0.0	1/2	128	—
10	22	4,194,302	/10	255.192.0.0	1/4	64	—
11	21	2,097,150	/11	255.224.0.0	1/8	32	—
12	20	1,048,574	/12	255.240.0.0	1/16	16	—
13	19	524,286	/13	255.248.0.0	1/32	8	—
14	18	262,142	/14	255.252.0.0	1/64	4	—
15	17	131,070	/15	255.254.0.0	1/128	2	—
16	16	65,534	/16	255.255.0.0	1/256	1	256
17	15	32,766	/17	255.255.128.0	—	1/2	128
18	14	16,382	/18	255.255.192.0	—	1/4	64

Table 56: CIDR Address Blocks and “Classful” Address Equivalents (Page 2 of 2)

# of Bits For Network ID	# of Bits For Host ID	# of Hosts Per Network	Prefix Length in Slash Notation	Equivalent Subnet Mask	# of Equivalent “Classful” Addressing Networks		
					Class A	Class B	Class C
19	13	8,190	/19	255.255.224.0	—	1/8	32
20	12	4,094	/20	255.255.240.0	—	1/16	16
21	11	2,046	/21	255.255.248.0	—	1/32	8
22	10	1,022	/22	255.255.252.0	—	1/64	4
23	9	510	/23	255.255.254.0	—	1/128	2
24	8	254	/24	255.255.255.0	—	1/256	1
25	7	126	/25	255.255.255.128	—	—	1/2
26	6	62	/26	255.255.255.192	—	—	1/4
27	5	30	/27	255.255.255.224	—	—	1/8
28	4	14	/28	255.255.255.240	—	—	1/16
29	3	6	/29	255.255.255.248	—	—	1/32
30	2	2	/30	255.255.255.252	—	—	1/64

IP CIDR Addressing Example

The multiple hierarchical levels of CIDR make the technology seem rather complicated. However, understanding how CIDR works really is not that difficult, assuming you already know how subnetting is done. In particular, [if you know how VLSM functions](#), you basically already know how CIDR does, since they are pretty much the same thing. They differ only in the way that the hierarchical division of networks is accomplished, and the terminology.

To show how CIDR works better, let's take an example that will illustrate the power of classless addressing: its ability to selectively subdivide a large block of addresses into smaller ones that suit the needs of various organizations. Since address allocation in CIDR typically starts with larger blocks owned by larger Internet Service Providers (ISPs), let's start there as well.

Suppose we have an ISP that is just starting up. It's not a “major” ISP, but a moderate-sized one with only a few customers, so it needs only a relatively small allocation. It begins with the block 71.94.0.0/15. The “/15” on the end of the block address tells us that this is a block of addresses where the first 15 bits are the network ID and the last 17 the host ID. Of course, this block was obtained from a larger ISP, carved from a larger block of addresses by that ISP. For example, 71.94.0.0/15 would be equal to half of the address block 71.92.0.0/14, a quarter of the block 71.88.0.0/13, and so on.

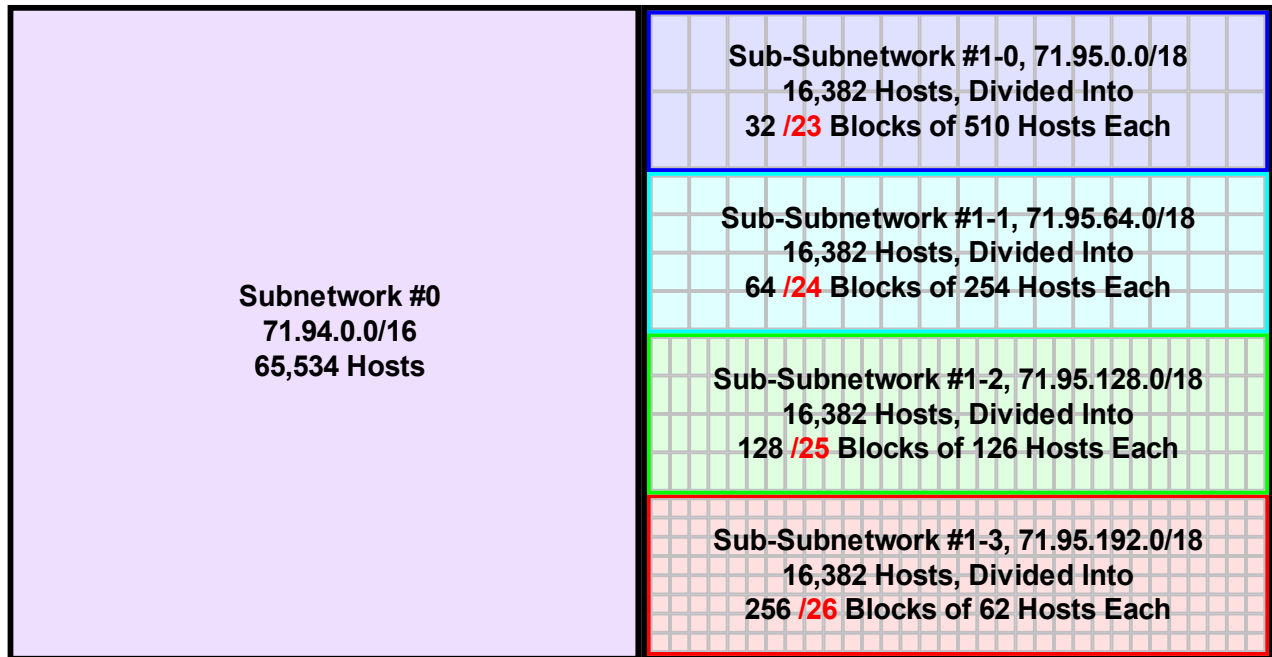

Full Network
71.94.0.0/15
131,070 Hosts

Figure 83: Example Hierarchical Division Of A /15 CIDR Address Block

This diagram shows one method by which an ISP with a relatively large /15 address block (131,070 hosts) might choose to hierarchically divide it. In this case it is first divided in half into two /16 blocks. One is reserved, while the other is divided into four /18 blocks. Each of those is divided into blocks of a different size, to allow allocation to organizations requiring up to 62, 126, 254 or 510 hosts respectively.

Our ISP's block is equal in size to two Class Bs and has a total of 131,070 possible host addresses. This ISP can choose to divide this block in a variety of ways, depending on the needs of its clients and its own internal use. However, this ISP is just starting up, so it is not even sure of what its ultimate needs will be. Let's say it expects to resell about half of its address space to other ISPs, but isn't sure what sizes they will need yet. Of the other half, it plans to split it into four different sizes of blocks to match the needs of different-sized organizations.

To imagine how the ISP divides its address space, we can consider the analogy of cutting up a pie. The ISP will first "cut the pie in half" and reserve one half for its future ISP customers. It will then cut the other half into some large pieces and some small pieces. This is illustrated in [Figure 83](#). (Okay, it's a square pie. I wanted to show the individual small blocks to scale. Sue me. ☺)

The actual process of division might follow this progression (illustrated in [Figure 84](#)):

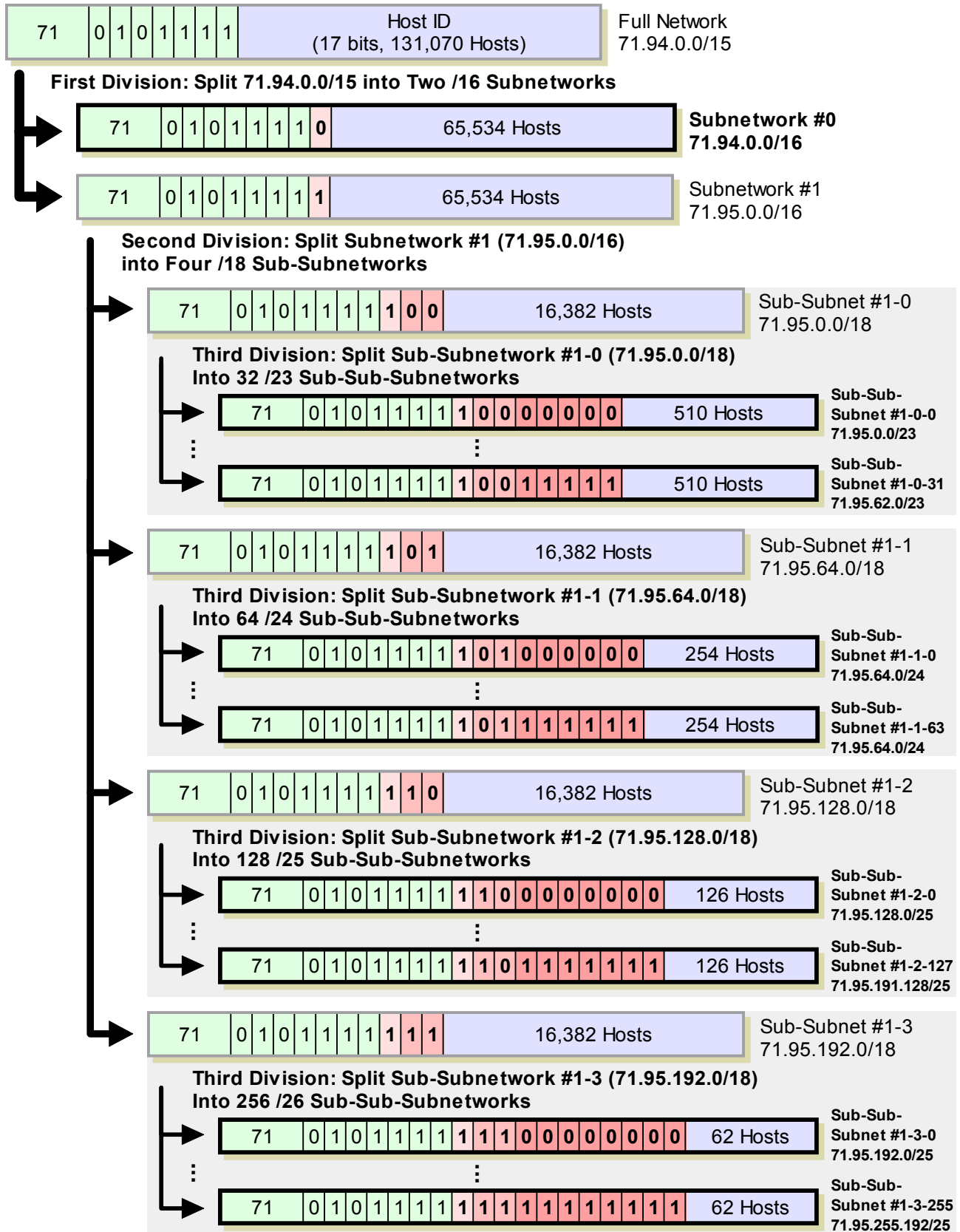

Figure 84: Hierarchical Address Division Using Classless Addressing (CIDR)

First Level of Division

The “pie” is initially cut down the middle by using the single left-most host ID bit as an extra network bit. Let's see our network address block, 71.94.0.0/15 in binary, with the left-most host ID bit shown highlighted:

01000111 01011110 00000000 00000000

To make the split, we make one network equal to this binary network address with the highlighted bit remaining zero, and the other one with it changed to a one. This creates two subnetworks—not subnets as in the “classful” sense of the word, but portions of the original network—which I have numbered based on the numeric value of what is substituted into the new network ID bits:

Subnetwork #0: 01000111 01011110 00000000 00000000

Subnetwork #1: 01000111 01011111 00000000 00000000

Since bit #16 is now also part of the network address, these are “/16” networks, the size of a “classful” Class B network. So, the subnetworks are:

Subnetwork #0: 71.94.0.0/16

Subnetwork #1: 71.95.0.0/16

You'll notice that the “#0” subnetwork has the same IP address as the larger network it came from; this is always true of the subnetwork 0 in a network.

Second Level of Division

Let's say we set aside subnetwork #0 above for future ISP allocations. We then choose to divide the second subnetwork, into four. These we will then further subdivide into different sizes to meet our customer needs. To divide into four groups we need two more bits from the host ID of subnetwork #1, shown highlighted and underlined next to the original subnet bit:

01000111 01011111 00000000 00000000

These two bits are replaced by the patterns 00, 01, 10 and 11 to get four sub-subnetworks. They will be “/18” networks of course, since we took two extra bits from the host ID of a “/16”:

Sub-subnetwork #1-0: 01000111 01011111 **00**000000 00000000
(71.95.0.0/18)

Sub-subnetwork #1-1: 01000111 01011111 **01**000000 00000000
(71.95.64.0/18)

Sub-subnetwork #1-2: 01000111 01011111 **10**000000 00000000
(71.95.128.0/18)

Sub-subnetwork #1-3: 01000111 01011111 **11**000000 00000000
(71.95.192.0/18)

Each of these has 16,382 addresses.

Third Level of Division

We now take each of the four /18 networks above and further subdivide it. We want to make each of these contain a number of blocks of different sizes corresponding to our potential customers. One way to do this would be as follows:

- ☉ **Larger Organizations:** Customers needing up to 510 addresses require a /23 network. We divide sub-subnetwork #1-0, 71.95.0.0/18 by taking five bits from the host ID field:

01000111 01011111 **00000000** 00000000

We substitute into these five bits 00000, 00001, 00010 and so on, giving us 32 different /23 networks in this block, each containing 9 bits for the host ID, for 510 hosts. The first will be sub-sub-subnetwork #1-0-0, 71.95.0.0/23; the second sub-sub-subnetwork #1-0-1, 71.95.2.0/23; the last will be sub-sub-subnetwork #1-0-31: 71.95.62.0/23.

- ☉ **Medium-Sized Organizations:** For customers needing up to 254 addresses, we divide sub-subnetwork #1-1, 71.95.64.0/18, by taking six bits from the host ID field:

01000111 01011111 **01000000** 00000000

This gives us 64 different /24 networks. The first will be sub-sub-subnetwork #1-1-0, 71.95.64.0/24, the second sub-sub-subnetwork #1-1-1, 71.95.65.0/24, and so on.

- ☉ **Smaller Organizations:** For customers with up to 126 hosts, we divide sub-subnetwork #1-2, 71.95.128.0/18, by taking seven bits from the host ID field:

01000111 01011111 **10000000** 00000000

Seven bits allow 128 of these /25 networks within our /18 block. The first will be 71.95.128.0/25, the second 71.95.128.128/25, the third 71.95.129.0/25, and so on.

-
- ☉ **Very Small Organizations:** For customers with up to 60 hosts, we divide sub-subnetwork #1-3, 71.95.192.0/18, by taking eight bits from the host ID field:

01000111 01011111 **11000000** 00000000

This gives us 256 different /26 networks within our /18 block. The first will be 71.95.192.0/26, the second 71.95.192.64/26, and so on.

Other Alternatives for Dividing the Network

Above all else, CIDR is about flexibility—this is only one of many different ways to slice up this pie (sheet of brownies, whatever!) The ISP might decide that creating four different sizes of customer networks in advance was not the right way to go. They might instead just take the tack of dividing the pie in half, dividing it in half again, and so on, as many times as needed to create “pie slices” of the right size. Alternately, if most of their customers need around 50, 100, 200 or 500 hosts, the example above might be the easiest to administer.

It would still be possible for the ISP to further divide any of the smaller blocks further if they needed. They could split a /26 sub-sub-subnetwork into four /28 sub-sub-sub-subnetworks for very small customers, for example. Also, an individual customer of this ISP could do the same thing, dividing their own block to suit the internal structure of their network.



IP Datagram Encapsulation and Formatting

The primary job of the Internet Protocol is the delivery of data between devices over an internetwork. On its journey between two hosts in an internet, this data may travel across many physical networks. To help ensure that the data is sent and received properly, it is *encapsulated* within a message called an *IP datagram*. This datagram includes several fields that help manage the operation of IP and ensure that data gets where it needs to go.

In this section I take a look at how the Internet Protocol takes data passed to it from higher layers and packages it for transmission. I begin with a general discussion of IP datagrams and encapsulation. I then describe the general format of IP datagrams, including the fields used in the IP header and how they are interpreted. I also include a brief discussion of IP datagram options and their use.



Background Information: this section assumes at least passing familiarity with [IP addressing concepts](#). It also makes reference to [the section on datagram fragmentation and reassembly](#).



Note: IP datagrams are sometimes called *IP packets*. Whether “datagram” or “packet” is the preferred term seems to depend on whom you ask; even the standards don’t use one term exclusively. On the other hand, I have seen IP datagrams called *IP frames*, and that’s definitely not correct! [The topic on messages and names](#) in the fundamentals chapter describes these terms more completely.

IP Datagram Encapsulation

In [the chapter describing the OSI Reference Model](#), I looked at several ways that protocols at various layers in a networking protocol stack interact with each other. One of the most important concepts in inter-protocol operation is that of *encapsulation*. Most data originates within the higher layers of the OSI model. The protocols at these layers pass the data down to lower layers for transmission, usually in the form of discrete messages. Upon receipt, each lower-level protocol takes the entire contents of the message received and encapsulates it into its own message format, adding a header and possibly a footer that contain important control information. [Encapsulation is explained in general terms in a separate topic](#).

A good analogy for how encapsulation works is a comparison to sending a letter enclosed in an envelope. You might write a letter and put it in a white envelope with a name and address, but if you gave it to a courier for overnight delivery, they would take that envelope and put it in a larger delivery envelope. ([I actually have written a complete description of this sort of analogy](#), if you are interested.)

Due to the prominence of TCP/IP, the Internet Protocol is one of the most important places where data encapsulation occurs on a modern network. Data is passed to IP typically from one of the two main transport layer protocols: TCP or UDP. This data is already in the form of a TCP or UDP message with TCP or UDP headers. This is then encapsulated into the body of an IP message, usually called an *IP datagram* or *IP packet*. Encapsulation and formatting of an IP datagram is also sometimes called *packaging*—again, the implied comparison to an envelope is obvious. The process is shown in [Figure 85](#).

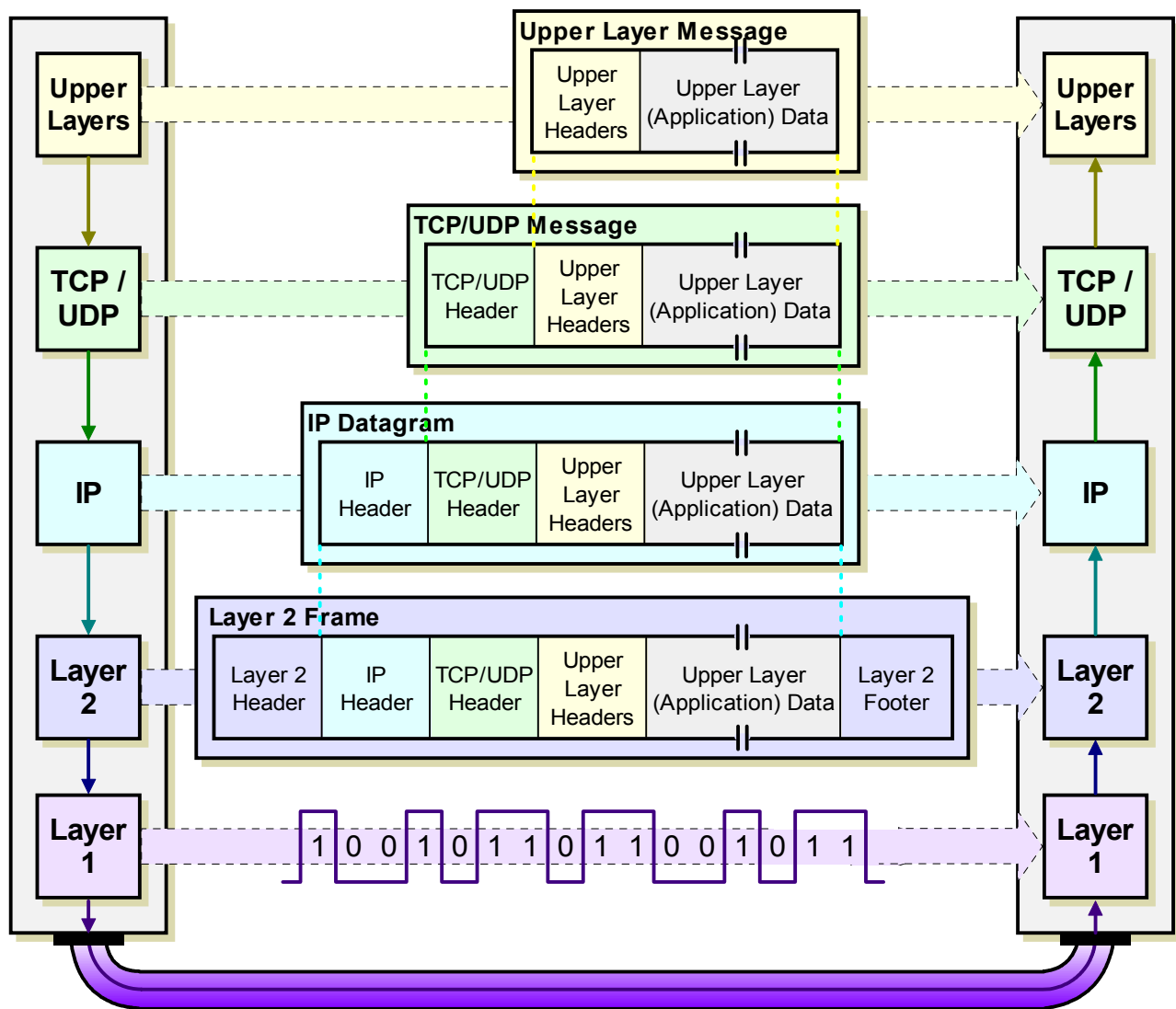

Figure 85: IP Datagram Encapsulation

This is an adaptation of [Figure 15](#), the very similar drawing for the OSI Reference Model as a whole, showing specifically how data encapsulation is accomplished in TCP/IP. As you can see, an upper layer message is packaged into a TCP or UDP message. This then becomes the payload of an IP datagram, which is shown here simply with one header (things can get a bit more complex than this.) The IP datagram is then passed down to layer 2 where it is in turn encapsulated into some sort of LAN, WAN or WLAN frame, then converted to bits and transmitted at the physical layer.

If the message to be transmitted is too large for the size of the underlying network, it may first be [fragmented](#). This is analogous to splitting up a large delivery into multiple smaller envelopes or boxes. In this case, each IP datagram carries only part of the higher-layer message. The receiving device must [reassemble the message](#) from the IP datagrams. So, a datagram doesn't always carry a full higher-layer message; it may hold only part of one.

The IP datagram is somewhat similar in concept to a frame used in Ethernet or another data link layer. The important difference, of course, is that IP datagrams are designed to facilitate transmission across an *internetwork*, while data link layer frames are used only for direct delivery within a physical network. The fields included in the IP header are used to manage internetwork datagram delivery. This includes key information for delivery such as the address of the destination device, identification of the type of frame, and control bits. [The header follows a specific format described in the following topic.](#)

After data is encapsulated into an IP datagram, it is passed down to the data link layer for transmission across the current “hop” of the internetwork. There, it is of course further encapsulated, IP header and all, into a data link layer frame such as an Ethernet frame. An IP datagram may be encapsulated into many such data link layer frames [as it is routed across the internetwork](#); on each hop the IP datagram is removed from the data link layer frame and then repackaged into a new one for the next hop. The IP datagram, however, is not changed (except for some control fields) until it reaches its final destination.

IP Datagram General Format

Data transmitted over an internet using IP is carried in messages called *IP datagrams*. Like all network protocol messages, IP uses a specific format for its datagrams. We are of course looking here at [IP version 4](#) and so we will examine the IPv4 datagram format, which was defined in RFC 791 along with the rest of IPv4.

The IPv4 datagram is conceptually divided into two pieces: the *header* and the *payload*. The header contains addressing and control fields, while the payload carries the actual data to be sent over the internetwork. Unlike some message formats, IP datagrams do not have a footer following the payload.

Even though IP is a relatively simple, connectionless, “unreliable” protocol, the IPv4 header carries a fair bit of information, which makes it rather large. At a minimum, it is 20 bytes long, and with options can be significantly longer. The IP datagram format is described in [Table 57](#) and illustrated in [Figure 86](#).

Table 57: Internet Protocol Version 4 (IPv4) Datagram Format (Page 1 of 3)

Field Name	Size (bytes)	Description												
Version	1/2 (4 bits)	Version: Identifies the version of IP used to generate the datagram. For IPv4, this is of course the number 4. The purpose of this field is to ensure compatibility between devices that may be running different versions of IP. In general, a device running an older version of IP will reject datagrams created by newer implementations, under the assumption that the older version may not be able to interpret the newer datagram correctly.												
IHL	1/2 (4 bits)	Internet Header Length (IHL): Specifies the length of the IP header, in 32-bit words. This includes the length of any options fields and padding. The normal value of this field when no options are used is 5 (5 32-bit words = 5*4 = 20 bytes). Contrast to the longer <i>Total Length</i> field below.												
TOS	1	Type Of Service (TOS): A field designed to carry information to provide quality of service features, such as prioritized delivery, for IP datagrams. It was never widely used as originally defined, and its meaning has been subsequently redefined for use by a technique called <i>Differentiated Services (DS)</i> . See below for more information.												
TL	2	Total Length (TL): Specifies the total length of the IP datagram, in bytes. Since this field is 16 bits wide, the maximum length of an IP datagram is 65,535 bytes, though most are much smaller.												
Identification	2	Identification: This field contains a 16-bit value that is common to each of the fragments belonging to a particular message; for datagrams originally sent unfragmented it is still filled in, so it can be used if the datagram must be fragmented by a router during delivery. This field is used by the recipient to reassemble messages without accidentally mixing fragments from different messages. This is needed because fragments may arrive from multiple messages mixed together, since IP datagrams can be received out of order from any device. See the discussion of IP message fragmentation.												
Flags	3/8 (3 bits)	<p>Flags: Three control flags, two of which are used to manage fragmentation (as described in the topic on fragmentation), and one that is reserved:</p> <table border="1"> <thead> <tr> <th>Subfield Name</th> <th>Size (bytes)</th> <th>Description</th> </tr> </thead> <tbody> <tr> <td>Reserved</td> <td>1/8 (1 bit)</td> <td>Reserved: Not used.</td> </tr> <tr> <td>DF</td> <td>1/8 (1 bit)</td> <td>Don't Fragment: When set to 1, specifies that the datagram should not be fragmented. Since the fragmentation process is generally "invisible" to higher layers, most protocols don't care about this and don't set this flag. It is, however, used for testing the maximum transmission unit (MTU) of a link.</td> </tr> <tr> <td>MF</td> <td>1/8 (1 bit)</td> <td>More Fragments: When set to 0, indicates the last fragment in a message; when set to 1, indicates that more fragments are yet to come in the fragmented message. If no fragmentation is used for a message, then of course there is only one "fragment" (the whole message), and this flag is 0. If fragmentation is used, all fragments but the last set this flag to 1 so the recipient knows when all fragments have been sent.</td> </tr> </tbody> </table>	Subfield Name	Size (bytes)	Description	Reserved	1/8 (1 bit)	Reserved: Not used.	DF	1/8 (1 bit)	Don't Fragment: When set to 1, specifies that the datagram should not be fragmented. Since the fragmentation process is generally "invisible" to higher layers, most protocols don't care about this and don't set this flag. It is, however, used for testing the maximum transmission unit (MTU) of a link.	MF	1/8 (1 bit)	More Fragments: When set to 0, indicates the last fragment in a message; when set to 1, indicates that more fragments are yet to come in the fragmented message. If no fragmentation is used for a message, then of course there is only one "fragment" (the whole message), and this flag is 0. If fragmentation is used, all fragments but the last set this flag to 1 so the recipient knows when all fragments have been sent.
Subfield Name	Size (bytes)	Description												
Reserved	1/8 (1 bit)	Reserved: Not used.												
DF	1/8 (1 bit)	Don't Fragment: When set to 1, specifies that the datagram should not be fragmented. Since the fragmentation process is generally "invisible" to higher layers, most protocols don't care about this and don't set this flag. It is, however, used for testing the maximum transmission unit (MTU) of a link.												
MF	1/8 (1 bit)	More Fragments: When set to 0, indicates the last fragment in a message; when set to 1, indicates that more fragments are yet to come in the fragmented message. If no fragmentation is used for a message, then of course there is only one "fragment" (the whole message), and this flag is 0. If fragmentation is used, all fragments but the last set this flag to 1 so the recipient knows when all fragments have been sent.												

Table 57: Internet Protocol Version 4 (IPv4) Datagram Format (Page 2 of 3)

Field Name	Size (bytes)	Description																																	
Fragment Offset	1 5/8 (13 bits)	Fragment Offset: When fragmentation of a message occurs, this field specifies the offset, or position, in the overall message where the data in this fragment goes. It is specified in units of 8 bytes (64 bits). The first fragment has an offset of 0. Again, see the discussion of fragmentation for a description of how the field is used.																																	
TTL	1	Time To Live (TTL): Short version: Specifies how long the datagram is allowed to “live” on the network, in terms of router hops. Each router decrements the value of the TTL field (reduces it by one) prior to transmitting it. If the TTL field drops to zero, the datagram is assumed to have taken too long a route and is discarded. See below for the longer explanation of <i>TTL</i> .																																	
Protocol	1	Protocol: Identifies the higher-layer protocol (generally either a transport layer protocol or encapsulated network layer protocol) carried in the datagram. The values of this field were originally defined by the IETF “Assigned Numbers” standard, RFC 1700, and are now maintained by the Internet Assigned Numbers Authority (IANA) : <table border="1"> <thead> <tr> <th>Value (Hexadecimal)</th> <th>Value (Decimal)</th> <th>Protocol</th> </tr> </thead> <tbody> <tr> <td>00</td> <td>0</td> <td>Reserved</td> </tr> <tr> <td>01</td> <td>1</td> <td>ICMP</td> </tr> <tr> <td>02</td> <td>2</td> <td>IGMP</td> </tr> <tr> <td>03</td> <td>3</td> <td>GGP</td> </tr> <tr> <td>04</td> <td>4</td> <td>IP-in-IP Encapsulation</td> </tr> <tr> <td>06</td> <td>6</td> <td>TCP</td> </tr> <tr> <td>08</td> <td>8</td> <td>EGP</td> </tr> <tr> <td>11</td> <td>17</td> <td>UDP</td> </tr> <tr> <td>32</td> <td>50</td> <td>Encapsulating Security Payload (ESP) Extension Header</td> </tr> <tr> <td>33</td> <td>51</td> <td>Authentication Header (AH) Extension Header</td> </tr> </tbody> </table> <p>Note that the last two entries are used when IPSec inserts additional headers into the datagram: the AH or ESP headers.</p>	Value (Hexadecimal)	Value (Decimal)	Protocol	00	0	Reserved	01	1	ICMP	02	2	IGMP	03	3	GGP	04	4	IP-in-IP Encapsulation	06	6	TCP	08	8	EGP	11	17	UDP	32	50	Encapsulating Security Payload (ESP) Extension Header	33	51	Authentication Header (AH) Extension Header
Value (Hexadecimal)	Value (Decimal)	Protocol																																	
00	0	Reserved																																	
01	1	ICMP																																	
02	2	IGMP																																	
03	3	GGP																																	
04	4	IP-in-IP Encapsulation																																	
06	6	TCP																																	
08	8	EGP																																	
11	17	UDP																																	
32	50	Encapsulating Security Payload (ESP) Extension Header																																	
33	51	Authentication Header (AH) Extension Header																																	
Header Checksum	2	Header Checksum: A checksum computed over the header to provide basic protection against corruption in transmission. This is not the more complex CRC code typically used by data link layer technologies such as Ethernet; it's just a 16-bit checksum. It is calculated by dividing the header bytes into words (a word is two bytes) and then adding them together. The data is not checksummed, only the header. At each hop the device receiving the datagram does the same checksum calculation and on a mismatch, discards the datagram as damaged.																																	

Table 57: Internet Protocol Version 4 (IPv4) Datagram Format (Page 3 of 3)

Field Name	Size (bytes)	Description
Source Address	4	Source Address: The 32-bit IP address of the originator of the datagram. Note that even though intermediate devices such as routers may handle the datagram, they do not normally put their address into this field—it is always the device that originally sent the datagram.
Destination Address	4	Destination Address: The 32-bit IP address of the intended recipient of the datagram. Again, even though devices such as routers may be the intermediate targets of the datagram, this field is always for the ultimate destination.
Options	Variable	Options: One or more of several types of options may be included after the standard headers in certain IP datagrams. I discuss them in the topic that follows this one .
Padding	Variable	Padding: If one or more options are included, and the number of bits used for them is not a multiple of 32, enough zero bits are added to “pad out” the header to a multiple of 32 bits (4 bytes).
Data	Variable	Data: The data to be transmitted in the datagram, either an entire higher-layer message or a fragment of one.

That’s a pretty big table, because the IP datagram format is pretty important and has a lot of fields that need explaining. To keep it from being even longer, I decided to move a couple of the more complex descriptions out of the table.

Time To Live (TTL) Field

Since IP datagrams are sent from router to router as they travel across an internetwork, it is possible that a situation could result where a datagram gets passed from router A to router B to router C and then back to router A. Router loops are not supposed to happen, and rarely do, but are possible.

To ensure that datagrams don’t circle around endlessly, the *TTL* field was intended to be filled in with a time value (in seconds) when a datagram was originally sent. Routers would decrease the time value periodically, and if it ever hit zero, the datagram would be destroyed. This was also intended to be used to ensure that time-critical datagrams wouldn’t linger past the point where they would be “stale”.

In practice, this field is not used in exactly this manner. Routers today are fast and usually take far less than a second to forward a datagram; measuring the time that a datagram “lives” would be impractical. Instead, this field is used as a “maximum hop count” for the datagram. Each time a router processes a datagram, it reduces the value of the *TTL* field by one. If doing this results in the field being zero, the datagram is said to have expired. It is dropped, and usually an ICMP *Time Exceeded* message is sent to inform the originator of the message that this happened.

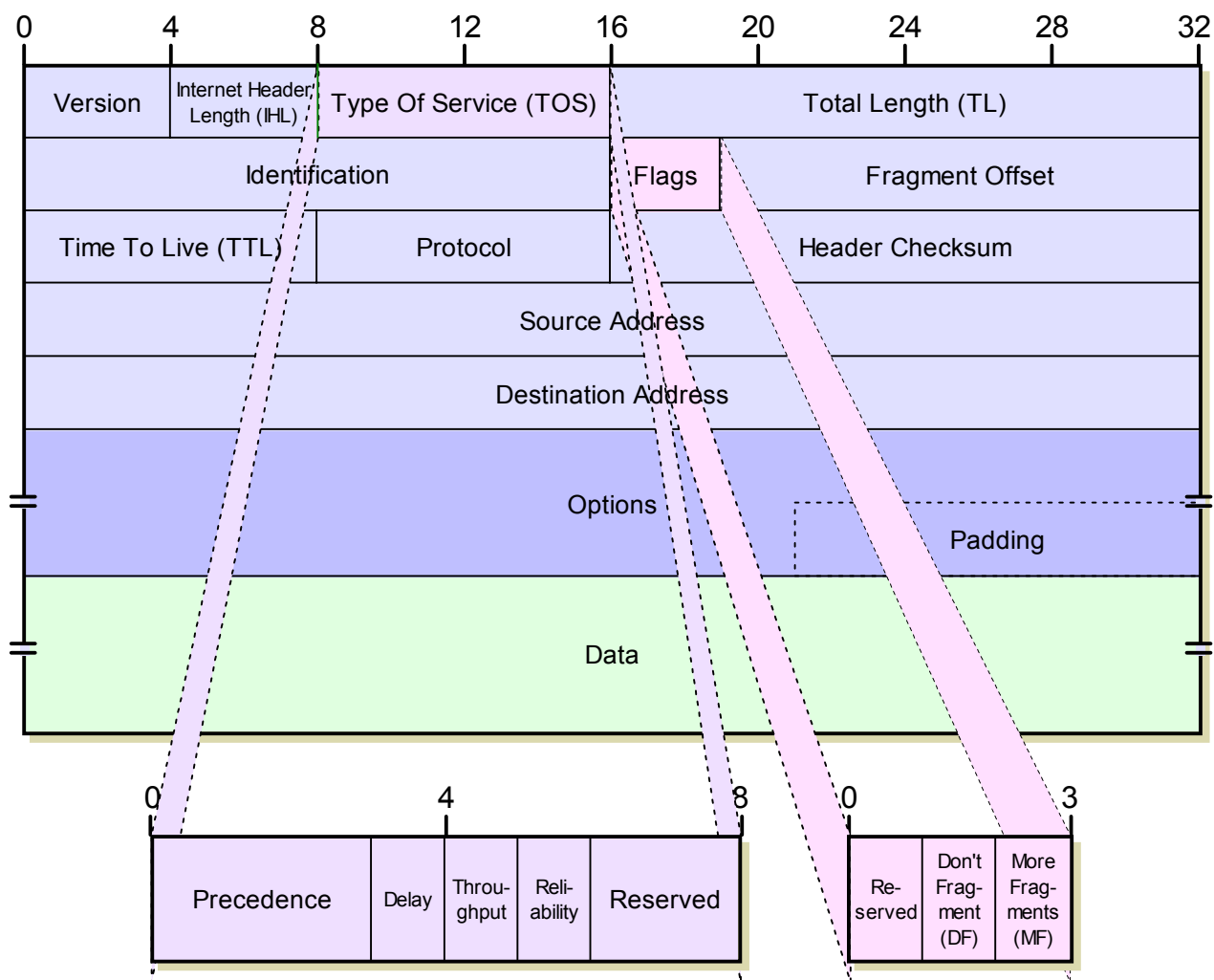

Figure 86: Internet Protocol Version 4 (IPv4) Datagram Format

This diagram shows graphically the all-important IPv4 datagram format. The first 20 bytes are the fixed IP header, followed by an optional *Options* section, and a variable-length *Data* area. Note that the *Type Of Service* field is shown as originally defined in the IPv4 standard.

The *TTL* field is one of the primary mechanisms by which networks are protected from router loops (see [the description of ICMP Time Exceeded messages](#) for more on how *TTL* helps IP handle router loops.)

Type Of Service (TOS) Field

This one-byte field was originally intended to provide certain [quality of service](#) features for IP datagram delivery. It allowed IP datagrams to be tagged with information indicating not only their precedence, but the preferred manner in which they should be delivered. It was divided into a number of subfields, as shown in [Table 58](#) (and [Figure 86](#)).

The lack of quality of service features has been considered a weakness of IP for a long time. But as we can see in [Table 58](#), these features were built into IP from the start. What's going on here? The answer is that even though this field was defined in the standard back in the early 1980s, it was not widely used by hardware and software. For years, it was just passed around with all zeroes in the bits and mostly ignored.

Table 58: Original Definition Of IPv4 Type Of Service (TOS) Field

Subfield Name	Size (bytes)	Description																		
Precedence	3/8 (3 bits)	<p>Precedence: A field indicating the priority of the datagram. There were eight defined values, from lowest to highest priority:</p> <table border="1"> <thead> <tr> <th>Precedence Value</th> <th>Priority Level</th> </tr> </thead> <tbody> <tr> <td>000</td> <td>Routine</td> </tr> <tr> <td>001</td> <td>Priority</td> </tr> <tr> <td>010</td> <td>Immediate</td> </tr> <tr> <td>011</td> <td>Flash</td> </tr> <tr> <td>100</td> <td>Flash Override</td> </tr> <tr> <td>101</td> <td>CRITIC/ECP</td> </tr> <tr> <td>110</td> <td>Internetwork Control</td> </tr> <tr> <td>111</td> <td>Network Control</td> </tr> </tbody> </table>	Precedence Value	Priority Level	000	Routine	001	Priority	010	Immediate	011	Flash	100	Flash Override	101	CRITIC/ECP	110	Internetwork Control	111	Network Control
Precedence Value	Priority Level																			
000	Routine																			
001	Priority																			
010	Immediate																			
011	Flash																			
100	Flash Override																			
101	CRITIC/ECP																			
110	Internetwork Control																			
111	Network Control																			
D	1/8 (1 bit)	Delay: Set to 0 to request “normal” delay in delivery; set to 1 if low delay delivery is requested.																		
T	1/8 (1 bit)	Throughput: Set to 0 to request “normal” delivery throughput; set to 1 if higher throughput delivery is requested.																		
R	1/8 (1 bit)	Reliability: Set to 0 to request “normal” reliability in delivery; set to 1 if higher reliability delivery is requested.																		
Reserved	2/8 (2 bits)	Reserved: Not used.																		

The [IETF](#), seeing the field unused, attempted to revive its use. In 1998, RFC 2474 redefines the first six bits of the *TOS* field to support a technique called *Differentiated Services (DS)*. Under DS, the values in the *TOS* field are called *codepoints* and are associated with different service levels. This starts to get rather complicated, so refer to RFC 2474 if you want all the details.

Understanding the IP datagram format is an important part of troubleshooting IP networks. Be sure to see the following topic on options for more information on how IP options are used in datagrams, and the [topic on fragmenting](#) for some more context on the use of fragmentation-related fields such as *Identification*, *Fragment Offset*, and *More Fragments*.

IP Datagram Options and Option Format

All IP datagrams must include the [standard 20-byte header](#), which contains key information such as the source and destination address of the datagram, fragmentation control parameters, length information and more. In addition to these invariable fields, the creators of IPv4 included the ability to add *options* that provide additional flexibility in how IP handles datagrams. Use of these options is, of course, optional. ☺ However, all devices that handle IP datagrams must be capable of properly reading and handling them.

The IP datagram may contain zero, one or more options, which makes the total length of the *Options* field in the IP header variable. Each of the options can be either a single byte long, or multiple bytes in length, depending on how much information the option needs to convey. When more than one option is included they are just concatenated together and put into the *Options* field as a whole. Since the IP header must be a multiple of 32 bits, a *Padding* field is included if the number of bits in all options together is not a multiple of 32 bits.

IP Option Format

Each IP option has its own subfield format, generally structured as shown in [Table 59](#) and [Figure 87](#). For most options, all three subfields are used: *Option Type*, *Option Length* and *Option Data*. For a few simple options, however, this complex substructure is not needed. In those cases, the option type itself communicates all the information required, so the *Option Type* field appears alone, while the *Option Length* and *Option Data* subfields are omitted.

Table 59: Internet Protocol Version 4 (IPv4) Option Format

Subfield Name	Size (bytes)	Description												
<i>Option Type</i>	1	<p>Option Type: This 8-bit field is divided into three “sub-subfields”, according to the following format:</p> <table border="1"> <thead> <tr> <th>Sub-Subfield Name</th> <th>Size (bytes)</th> <th>Description</th> </tr> </thead> <tbody> <tr> <td><i>Copied</i></td> <td>1/8 (1 bit)</td> <td>Copied Flag: This bit is set to 1 if the option is intended to be copied into all fragments when a datagram is fragmented; it is cleared to 0 if the option should not be copied into fragments.</td> </tr> <tr> <td><i>Option Class</i></td> <td>2/8 (2 bits)</td> <td>Option Class: Specifies one of four potential values that indicate the general category into which the option belongs. In fact, only two of the values are used: 0 is for <i>Control</i> options, and 2 for <i>Debugging and Measurement</i>.</td> </tr> <tr> <td><i>Option Number</i></td> <td>5/8 (5 bits)</td> <td>Option Number: Specifies the kind of option. 32 different values can be specified for each of the two option classes. Of these, a few are more commonly employed. See below for more information on the specific options.</td> </tr> </tbody> </table>	Sub-Subfield Name	Size (bytes)	Description	<i>Copied</i>	1/8 (1 bit)	Copied Flag: This bit is set to 1 if the option is intended to be copied into all fragments when a datagram is fragmented; it is cleared to 0 if the option should not be copied into fragments.	<i>Option Class</i>	2/8 (2 bits)	Option Class: Specifies one of four potential values that indicate the general category into which the option belongs. In fact, only two of the values are used: 0 is for <i>Control</i> options, and 2 for <i>Debugging and Measurement</i> .	<i>Option Number</i>	5/8 (5 bits)	Option Number: Specifies the kind of option. 32 different values can be specified for each of the two option classes. Of these, a few are more commonly employed. See below for more information on the specific options.
		Sub-Subfield Name	Size (bytes)	Description										
		<i>Copied</i>	1/8 (1 bit)	Copied Flag: This bit is set to 1 if the option is intended to be copied into all fragments when a datagram is fragmented; it is cleared to 0 if the option should not be copied into fragments.										
		<i>Option Class</i>	2/8 (2 bits)	Option Class: Specifies one of four potential values that indicate the general category into which the option belongs. In fact, only two of the values are used: 0 is for <i>Control</i> options, and 2 for <i>Debugging and Measurement</i> .										
<i>Option Number</i>	5/8 (5 bits)	Option Number: Specifies the kind of option. 32 different values can be specified for each of the two option classes. Of these, a few are more commonly employed. See below for more information on the specific options.												
<i>Option Length</i>	0 or 1	Option Length: For variable-length options, indicates the size of the entire option, including all three subfields shown here, in bytes.												
<i>Option Data</i>	0 or Variable	Option Data: For variable-length options, contains data to be sent as part of the option.												

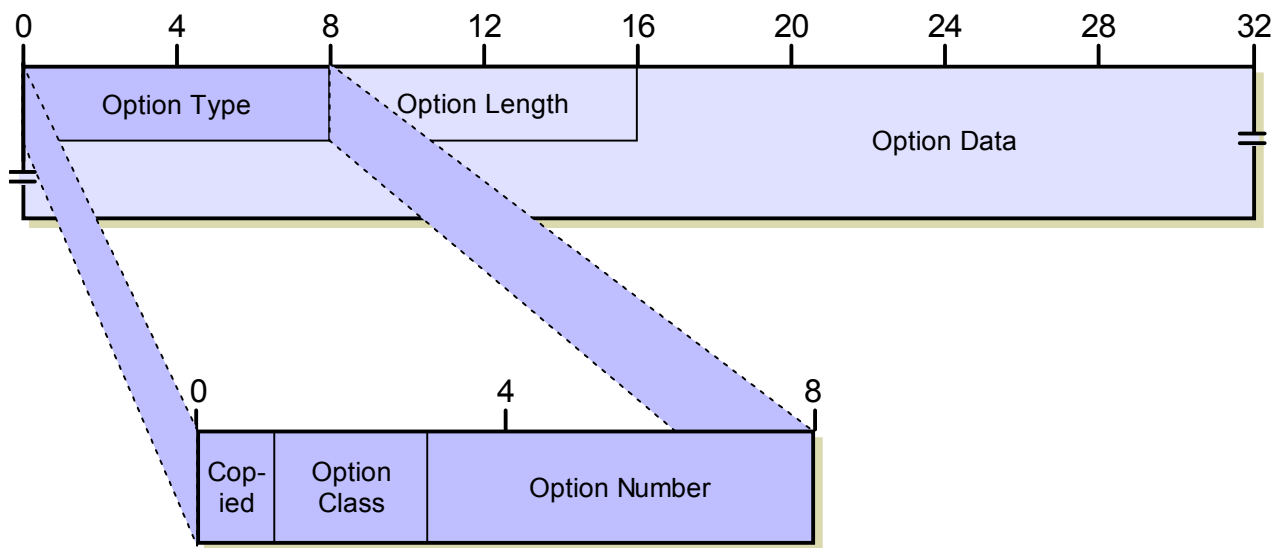

Figure 87: Internet Protocol Version 4 (IPv4) Option Format

This diagram shows the full field format for an IPv4 option. Note that a few simple options may consist of only the *Option Type* subfield, with the *Option Length* and *Option Data* subfields omitted.

IP Options

Table 60 lists the most common IPv4 options, showing the option class, option number and length for each (a length of 1 indicating an option that consists of only an Option Type field), and providing a brief description of how each is used.

Table 60: Internet Protocol Version 4 (IPv4) Options (Page 1 of 2)

Option Class	Option Number	Length (bytes)	Option Name	Description
0	0	1	<i>End Of Options List</i>	An option containing just a single zero byte, used to mark the end of a list of options.
0	1	1	<i>No Operation</i>	A “dummy option” used as “internal padding” to align certain options on a 32-bit boundary when required.
0	2	11	<i>Security</i>	An option provided for the military to indicate the security classification of IP datagrams.
0	3	Variable	<i>Loose Source Route</i>	One of two options for source routing of IP datagrams. See below for an explanation.

Table 60: Internet Protocol Version 4 (IPv4) Options (Page 2 of 2)

Option Class	Option Number	Length (bytes)	Option Name	Description
0	7	Variable	<i>Record Route</i>	<p>This option allows the route used by a datagram to be recorded within the header for the datagram itself. If a source device sends a datagram with this option in it, each router that “handles” the datagram adds its IP address to this option. The recipient can then extract the list of IP addresses to see the route taken by the datagram.</p> <p>Note that the length of this option is set by the originating device. It cannot be enlarged as the datagram is routed, and if it “fills up” before it arrives at its destination, only a partial route will be recorded.</p>
0	9	Variable	<i>Strict Source Route</i>	<p>One of two options for source routing of IP datagrams. See below for an explanation.</p>
2	4	Variable	<i>Timestamp</i>	<p>This option is similar to the <i>Record Route</i> option. However, instead of each device that handles the datagram inserting its IP address into the option, it puts in a timestamp, so the recipient can see how long it took for the datagram to travel between routers.</p> <p>As with the <i>Record Route</i> option, the length of this option is set by the originating device and cannot be enlarged by intermediate devices.</p>
2	18	12	<i>Traceroute</i>	<p>Used in the enhanced implementation of the traceroute utility, as described in RFC 1393. Also see the topic on the ICMP Traceroute messages.</p>



Key Concept: Each IPv4 datagram has a 20-byte mandatory header, and may also include one or more *options*. Each option has its own field format, and most are variable in size.

IP Options and Source Routing

Normally, IP datagrams are routed without any specific instructions from devices regarding the path a datagram should take from the source to the destination. [It's the job of routers](#), using routing protocols, to figure out those details. In some cases, however, it may be advantageous to have the source of a datagram specify the route a datagram takes through the network. This is called *source routing*.

There are two IP options that support source routing. In each, the option includes a list of IP addresses specifying the routers that must be used, to reach the destination. When *strict* source routing is used, this means that the path specified in the option must be used

exactly, in sequence, with no other routers permitted to handle the datagram at all. In contrast, *loose* source routing specifies a list of IP addresses that must be followed in sequence, but having intervening hops in between the devices on the list is allowed.

For full details on the exact structure used by each option type, please refer to RFC 791.



IP Datagram Size, Maximum Transmission Unit (MTU), Fragmentation and Reassembly

IP's main responsibility is to deliver data between internetworked devices. As we saw in the preceding section, this requires that data received from higher layers be encapsulated into IP datagrams for transmission. These datagrams are then passed down to the data link layer where they are sent over physical network links.

In order for this to work properly, each datagram must be small enough to fit within the frame format of the underlying technology. If the message is bigger than the maximum frame size of the underlying network, it may be necessary to break up an IP message into several datagrams, a process called *fragmentation*. The datagrams are then sent individually and *reassembled* into the original message.

The Internet Protocol is designed to manage datagram size, and to allow fragmentation and reassembly in a seamless manner. In this section I explore issues related to managing the size of IP datagrams. I start with an overview of datagram size issues and the important concept of a network's maximum transmission unit (MTU), discussing why fragmentation is necessary. I then describe the process by which IP messages to be transmitted are fragmented by the source device and possibly routers along the path to the destination, and then outline how they are reassembled by the recipient.



Background Information: Explaining fragmentation and reassembly requires some understanding of the basic format of IP datagrams and some of the fields they contain. If you haven't yet read [the topic describing IP datagram general format](#) you may wish to review it before proceeding here.

IP Datagram Size, the Maximum Transmission Unit (MTU), and Fragmentation Overview

As the core network layer protocol of the TCP/IP protocol suite, IP is designed to implement potentially large internetworks of devices. When we work with IP we get used to the concept of hosts being able to send information back and forth even though they may be quite far away and the data may need to travel across many devices between them. Even though we can usually consider the TCP/IP internet to be like a large, abstract “virtual network” of devices, we must always remember that underneath the network layer, data always travels across one or more physical networks. The implementation of the Internet Protocol must take this reality into account as well.

In order to send messages using IP we [encapsulate the higher-layer data into IP datagrams](#). These datagrams must then be sent down to the data link layer, where they are further encapsulated into the frames of whatever technology is going to be used to physically convey them, either directly to their destination, or indirectly to the next intermediate step in their journey to their intended recipient. The data link layer implementation puts the entire IP datagram into the data portion (the payload) of its frame format, just as IP puts

transport layer messages, transport headers and all, into its IP *Data* field. This immediately presents us with a potential issue: matching the size of the IP datagram to the size of the underlying data link layer frame size.

Matching IP Datagram Size to Underlying Network Frame Size

The underlying network that a device uses to connect to other devices could be LAN connection like Ethernet or Token Ring, a wireless LAN link such as 802.11, or a dialup, DSL, T-1 or other WAN connection. Each physical network will generally use its own frame format, and each format has a limit on how much data can be sent in a single frame. If the IP datagram is too large for the data link layer frame format's payload section, we have a problem!

For example, consider an FDDI. The maximum size of the data field in FDDI is around 4,470, depending on whether or not SNAP is used. This means FDDI can handle an IP datagram of up to 4,470 bytes. In contrast, a regular Ethernet frame uses a frame format that limits the size of the payload it sends to 1,500 bytes. This means Ethernet can't deal with IP datagrams greater than 1,500 bytes in size.

Now, remember that in sending a datagram across an internetwork, it may pass across more than one physical network. To access a site on the Internet, for example, we typically send a request through our local router, which then connects to other routers that eventually relay the request to the Internet site. Each hop as the datagram is forwarded may use a different physical network, with a different maximum underlying frame size.

The whole idea behind a network layer protocol is to implement this concept of a “virtual network” where devices talk even though they are far away. This means that higher layers shouldn't need to worry about details like the size limits of underlying data link layer technologies. However, someone has to worry about it. This task falls to the Internet Protocol.

Maximum Transmission Unit (MTU) and Datagram Fragmentation

The IP implementation of all devices on an IP internet needs to be aware of the capacity of the technology used by that implementation for its immediate data link layer connection to other devices. This limit is called the *maximum transmission unit (MTU)* of the network. This term is also sometimes seen as the *maximum transfer unit*.

If an IP layer receives a message to be sent across the internetwork, it looks at the size of the message and then computes how large the IP datagram would be after the addition of the 20 or more bytes needed for the IP header. If the total length is greater than the MTU of the underlying network, the IP layer will fragment the message into multiple IP fragments. So, if a host is connected using an Ethernet LAN to its local network, it may use an MTU of 1,500 for IP datagrams, and will fragment anything larger. [Figure 88](#) shows an example of differing MTUs and fragmentation.



Key Concept: The size of the largest IP datagram that can be transmitted over a physical network is called that network's *maximum transmission unit (MTU)*. If a datagram is passed from a network with a high MTU to one with a low MTU, it must be *fragmented* to fit the network with the smaller MTU.

Since some physical networks on the path between devices may have a smaller MTU than others, it may be necessary to fragment more than once. For example, suppose the source device wants to send an IP message 12,000 bytes long. Its local connection has an MTU of 3,300 bytes. It will have to divide this message into four fragments for transmission: three that are about 3,300 bytes long and a fourth remnant about 2,100 bytes long. (I'm oversimplifying by ignoring the extra headers required; [the next topic includes the full details of the fragmentation process.](#))

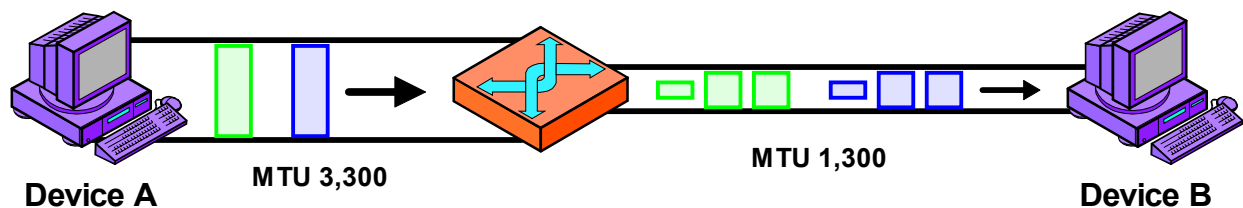

Figure 88: IP Maximum Transmission Unit (MTU) and Fragmentation

In this simple example, Device A is sending to Device B over a small internetwork consisting of one router and two physical links. The link from A to the router has an MTU of 3,300 bytes, but from the router to B it is only 1,300 bytes. Thus, any IP datagrams over 1,300 bytes will need to be fragmented.

Multiple-Stage Fragmentation

While the fragments above are in transit, they may need to pass over a hop between two routers where the physical network's MTU is only 1,300 bytes. In this case, each of the fragments will again need to be fragmented. The 3,300 byte fragments will end up in three pieces each (two of about 1,300 bytes and one of around 700 bytes) and the final 2,100-byte fragment will become a 1300-byte and 800-byte fragment. So instead of having four fragments, we will end up with eleven ($3*3+1*2$)! This is illustrated in [Figure 89](#).

Internet Minimum MTU: 576 Bytes

Each router must be able to fragment as needed to handle IP datagrams up to the size of the largest MTU used by networks to which they attach. Routers are also required, as a minimum, to handle an MTU of at least 576 bytes. This value is specified in RFC 791, and was chosen to allow a "reasonable sized" data block of at least 512 bytes, plus room for the standard IP header and options. Since it is the minimum size specified in the IP standard, 576 bytes has become a common default MTU value used for IP datagrams. Even if a host is connected over a local network with an MTU larger than 576, it may choose to use an MTU value of 576 anyway, to ensure that no further fragmentation will be required by intermediate routers.

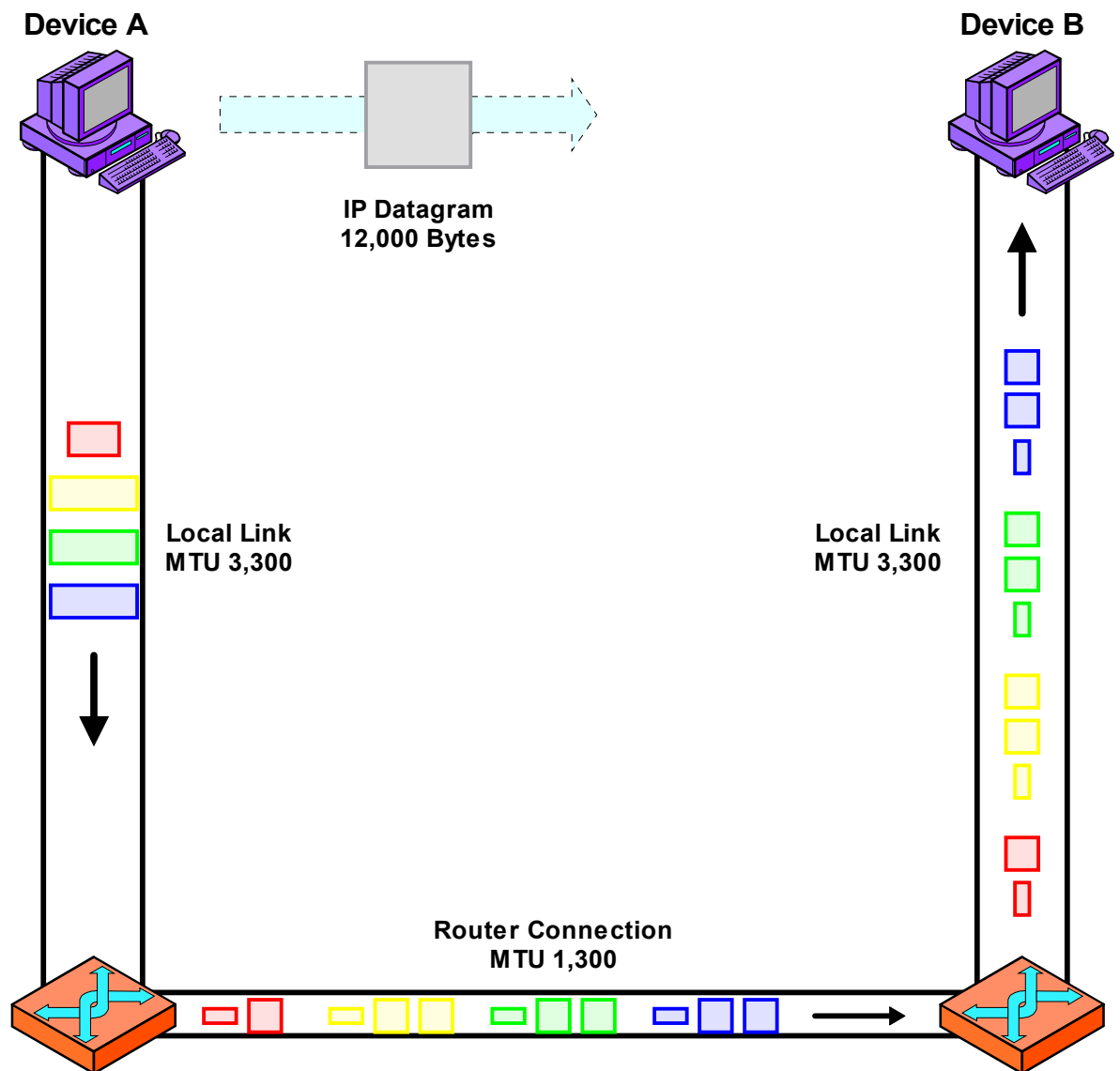

Figure 89: IPv4 Datagram Fragmentation

This example shows illustrates a two-step fragmentation of a large IP datagram. The boxes represent datagrams or datagram fragments and are shown to scale. The original datagram is 12,000 bytes in size, represented by the large gray box. To transmit this data over the first local link, Device A splits it into four fragments, shown at left in four primary colors. The first router must fragment each of these into smaller fragments to send them over the 1,300-byte MTU link, as shown on the bottom. Note that the second router does *not* reassemble the 1,300-byte fragments, even though its link to Device B has an MTU of 3,300 bytes. (Figure 90 shows the process by which the fragments in this example are created.)

Note that while intermediate routers may further fragment an already-fragmented IP message, intermediate devices do not reassemble fragments. Reassembly is done only by the recipient device. This has some advantages and some disadvantages, as we will see when we examine [the reassembly process](#).

MTU Path Discovery

When trying to send a great deal of data, efficiency in message transmissions becomes important. The larger each IP datagram we send, the smaller the percentage of bytes wasted for overhead such as header fields. This means that ideally, we want to use as large an MTU as possible without fragmentation occurring.

Determining the optimal MTU to use for a route between two devices requires knowing the MTU of every link on that route—information that the end-points of the connection simply don't have. They can determine the MTU of the overall route, however, using a clever technique called *path MTU discovery*. I call this technique “clever” because it does not use any special feature designed for the particular purpose of determining a route's MTU, but rather an error reporting mechanism built into TCP/IP [Internet Control Message Protocol \(ICMP\)](#).

One of the message types defined in ICMPv4 is the [Destination Unreachable message](#), which is returned under various conditions where an IP datagram cannot be delivered. One of these situations is when a datagram is sent that is too large to be forwarded by a router over a physical link *but* which has its *Don't Fragment (DF)* flag set to prevent fragmentation. In this case, the datagram must be discarded and a *Destination Unreachable* message sent back to the source. A device can exploit this capability by testing the path with datagrams of different sizes, to see how large they must be before they are rejected.

The source node typically sends a datagram that has the MTU of its local physical link, since that represents an upper bound on the MTU of any path to or from that device. If this goes through without any errors, it knows it can use that value for future datagrams to that destination. If it gets back any *Destination Unreachable - Fragmentation Needed and DF Set* messages, this means some other link between it and the destination has a smaller MTU. It tries again using a smaller datagram size, and continues until it finds the largest MTU that can be used on the path.

IP Message Fragmentation Process

When an IP datagram is too large for the [maximum transmission unit \(MTU\)](#) of the underlying data link layer technology used for the next leg of its journey, it must be *fragmented* before it can be sent across the network. The higher-layer message to be transmitted is not sent in a single IP datagram but rather broken down into pieces called *fragments* that are sent separately. In some cases, the fragments themselves may need to be fragmented further.

Fragmentation Issues and Concerns

Fragmentation is necessary to implement a network-layer internet that is independent of lower layer details, but introduces significant complexity to IP. Remember that IP is an unreliable, connectionless protocol. IP datagrams can take any of several routes on their way from the source to the destination, and some may not even make it to the destination at all. When we fragment a message we make a single datagram into many, which introduces several new issues to be concerned with:

-
- ① **Sequencing and Placement:** The fragments will typically be sent in sequential order from the beginning of the message to the end, but they won't necessarily show up in the order in which they were sent. The receiving device must be able to determine the sequence of the fragments to reassemble them in the correct order. In fact, some implementations send the last fragment first, so the receiving device will immediately know the full size of the original complete datagram. This makes keeping track of the order of segments even more essential.
 - ② **Separation of Fragmented Messages:** A source device may need to send more than one fragmented message at a time; or, it may send multiple datagrams that are fragmented en route. This means the destination may be receiving multiple sets of fragments that must be put back together. Imagine a box into which the pieces from two, three or more jigsaw puzzles have been mixed and you understand this issue.
 - ③ **Completion:** The destination device has to be able to tell when it has received all of the fragments so it knows when to start reassembly (or when to give up if it didn't get all the pieces).

To address these concerns and allow the proper reassembly of the fragmented message, IP includes several fields in the [IP format header](#) that convey information from the source to the destination about the fragments. Some of these contain a common value for all the fragments of the message, while others are different for each fragment.

The IP Fragmentation Process: An Example

The device performing the fragmentation follows a specific algorithm to divide the message into fragments for transmission. The exact implementation of the fragmentation process depends on the device. Let's take the same example from the previous topic, an IP message 12,000 bytes wide (including the 20-byte IP header) that needs to be sent over a link with an MTU of 3,300. Here's a typical method by which this fragmentation might be performed (you may find the illustration in [Figure 90](#) helpful):

1. **Create First Fragment:** The first fragment is created by taking the first 3,300 bytes of the 12,000-byte IP datagram. This includes the original header, which becomes the IP header of the first fragment (with certain fields changed as described below). So, 3,280 bytes of data are in the first fragment. This leaves 8,700 bytes to encapsulate (11,980 minus 3,280).
2. **Create Second Fragment:** The next 3,280 bytes of data are taken from the 8,700 bytes that remain after the first fragment was built, and paired with a new header to create fragment #2. This leaves 5,420 bytes.
3. **Create Third Fragment:** The third fragment is created from the next 3,280 bytes of data, with a 20-byte header. This leaves 2,140 bytes of data.
4. **Create Fourth Fragment:** The remaining 2,140 bytes are placed into the fourth fragment, with a 20-byte header of course.

I want to emphasize two important points here. First, IP fragmentation does **not** work by fully encapsulating the original IP message into the *Data* fields of the fragments. If this were done, the first 20 bytes of the *Data* field of the first fragment would contain the original IP header. This technique is used by some other protocols, such as the [PPP Multilink Protocol](#), but not by IP. The original IP header is “transformed” into the IP header of the first fragment.

MF	Offset	Data
0	0	11,980 bytes

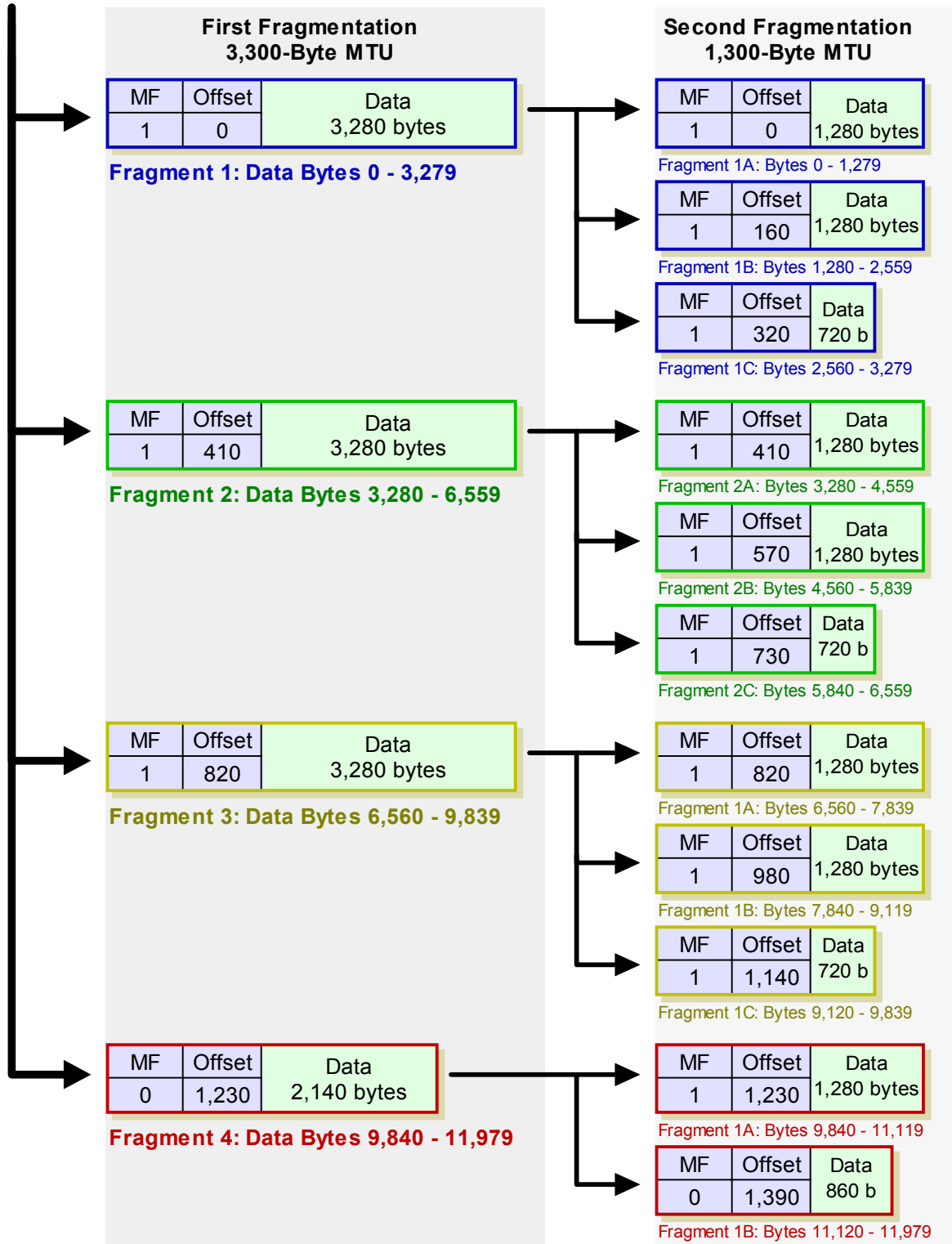

Figure 90: IPv4 Datagram Fragmentation Process

In this diagram, the *MF* and *Fragment Offset* fields of each fragment are shown for reference. The *Data* fields are shown to scale (the length of each is proportional to the number of bytes in the fragment.)

Second, note that the total number of bytes transmitted increases: we are sending 12,060 bytes (3,300 times three plus 2,160) instead of 12,000. The extra 60 bytes are from the additional headers in the second, third and fourth fragments. (The increase in size could theoretically be even larger if the headers contain options.)

Fragmentation-Related IP Datagram Header Fields

When a sending device or router fragments a datagram, it must provide information that will allow the receiving device to be able to identify the fragments and reassemble them into the datagram that was originally sent. This information is recorded by the fragmenting device in a number of fields in the IP datagram header.

Total Length

After fragmenting, this field indicates the length of each fragment, not the length of the overall message. Normally, the fragment size is selected to match the MTU value in bytes. However, fragments must have a length that is a multiple of 8, to allow proper offset specification (see below). The last fragment will usually be shorter than the others because it will contain a “leftover” piece, unless the message length happens to be an exact multiple of the fragment size.

Identification

To solve the “many jigsaw puzzles in a box” problem, a unique identifier is assigned to each message being fragmented. Consider this like writing a different number on the bottom of each piece of a jigsaw puzzle before tossing it into the box. This value is placed in the *Identification* field in the IP header of each fragment sent. The *Identification* field is 16 bits wide, so a total of 65,536 different identifiers can be used.

Obviously, we want to make sure that each message sent between the same source and destination that is being fragmented has a different identifier. The source can decide how it generates unique identifiers. This may be done through something as simple as a counter that is incremented each time a new set of fragments is created.

More Fragments

This flag is set to a 1 for all fragments except the last one, which has it set to 0. When the fragment with a value of 0 in the *More Fragments* flag is seen, the destination knows it has received the last fragment of the message.

Fragment Offset

This field solves the problem of sequencing fragments by indicating to the recipient device where in the overall message each particular fragment should be placed. The field is 13 bits wide, so the offset can be from 0 to 8191. Fragments are specified in units of 8 bytes, which is why fragment length must be a multiple of 8. Uncoincidentally, $8191 * 8$ is 65,528, just about the maximum size allowed for an IP datagram.

Let's take the same example from above. The first fragment would have a *Fragment Offset* of 0. The second would have an offset of 410 (3,280 divided by 8). The third would have an offset of 820 (6,560 divided by 8). The fourth would have an offset of 1230.



Key Concept: When an MTU requirement forces a datagram to be fragmented, it is split into several smaller IP datagrams, each containing part of the original. The header of the original datagram is changed into the header of the first fragment, and new headers are created for the other fragments. Each is set to the same *Identification* value to mark them as part of the same original datagram. The *Fragment Offset* of each is set to the location where the fragment belongs in the original. The *More Fragments* field is set to 1 for all fragments but the last, to let the recipient know when it has received all the fragments.

IP Header Flags Related to Fragmentation

In addition to the fields above, there are a couple of flags in the IP header related to fragmentation.

The Copied Flag

If a datagram containing options must be fragmented, some of the options may be copied to each of the fragments. This is controlled by the *Copied* flag in each option field.

The Don't Fragment Flag

This flag can be set to 1 by a transmitting device to specify that a datagram not be fragmented in transit. This may be used in certain circumstances where the entire message must be delivered intact as pieces may not make sense. It may also be used if the destination device has a limited IP implementation and can't reassemble fragments, and is also used for testing the [maximum transmission unit \(MTU\)](#) of a link. Normally, however, devices don't care about fragmentation and this field is left at zero.

What happens if a router encounters a datagram too large to pass over the next physical network but with the *Don't Fragment* bit set to 1? It can't fragment the datagram and it can't pass it along either, so it is "stuck". It will generally drop the datagram, and then send back a special [ICMP Destination Unreachable error message](#): "Fragmentation Needed and *Don't Fragment* Bit Set". This is used in MTU Path Discovery as described in the preceding section.

IP Message Reassembly Process

When a datagram is fragmented, either by the originating device or by one or more routers transmitting the datagram, it becomes multiple fragment datagrams. The destination of the overall message must collect these fragments and then *reassemble* them into the original message. Reassembly is accomplished by using the special information in the fields we saw in the preceding topic to help us "put the jigsaw puzzle back together again".

Asymmetry of Fragmentation and Reassembly

It's important to understand that while reassembly is the complement to fragmentation, the two processes are not symmetric. A primary differentiation between the two is that while intermediate routers can fragment a single datagram or further fragment a datagram that is already a fragment, intermediate devices do not perform reassembly. This is done only by the ultimate destination of the IP message. So, if a datagram at an intermediate router on one side of a physical network with an [MTU](#) of 1,300 causes fragmentation of a 3,300 byte datagram, the router on the other end of this 1,300 MTU link will *not* restore the 3,000 byte datagram to its original state. It will send all the 1,300 byte fragments on down the internet, as shown in [Figure 89](#).

There are a number of reasons why the decision was made to implement IP reassembly this way. Perhaps the most important one is that fragments can take different routes to get from the source to destination, so any given router may not see all the fragments in a message. Another reason is that having routers need to worry about reassembling fragments would increase their complexity. Finally, as we will see, reassembly of a message requires that we wait for all fragments before sending on the reassembled message. Having routers do this would slow routing down. Since routers don't reassemble they can immediately forward all fragments on to the ultimate recipient.

However, there are drawbacks to this design as well. One is that it results in more smaller fragments traveling over longer routes than if intermediate reassembly occurred. This increases the chances of a fragment going missing and the entire message being discarded. Another is a potential inefficiency in the utilization of data link layer frame capacity. In the example above, the 1,300-byte fragments would not be reassembled back into a 3,300 byte datagram at the end of the 1,000-MTU link. If the next link after that one also had an MTU of 3,300, we would have to send three frames, each encapsulating a 1,300-byte fragment, instead of a single larger frame, which is slightly slower.



Key Concept: In IPv4, fragmentation can be performed by a router between the source and destination of an IP datagram, but reassembly is only done by the destination device.

The Reassembly Process

As we saw in looking at [how fragmentation works](#), it involves a fair bit of complexity. Several IP header fields are filled in when a message is fragmented to give the receiving device the information it requires to properly reassemble the fragments. The receiving device follows a procedure to keep track of the fragments as they are received and build up its copy of the total received message from the source device. Most of its efforts are geared around dealing with the potential difficulties associated with IP being an unreliable protocol.

The details of implementation of the reassembly process are specific to each device, but generally include the following functions:

-
- ☉ **Fragment Recognition and Fragmented Message Identification:** The recipient knows it has received a message fragment the first time it sees a datagram with the *More Fragments* bit set to one or the *Fragment Offset* a value other than zero. It identifies the message based on: the source and destination IP addresses; the protocol specified in the header; and the *Identification* field generated by the sender.
 - ☉ **Buffer Initialization:** The receiving device initializes a buffer where it can store the fragments of the message as they are received. It keeps track of which portions of this buffer have been filled with received fragments, perhaps using a special table. By doing this, it knows when the buffer is partially filled with received fragments and when it is completely full.
 - ☉ **Timer Initialization:** The receiving device sets up a timer for reassembly of the message. Since it is possible that some fragments may never show up, this timer ensures that the device will not wait “forever” trying to reassemble the message.
 - ☉ **Fragment Receipt and Processing:** Whenever a fragment of this message arrives (as indicated by it having the same source and destination addresses, protocol and *Identification* as the first fragment), the fragment is processed. It is inserted into the message buffer in the location indicated by its *Fragment Offset* field. The device also makes note of the fact that this portion of the message has been received.

Reassembly is finished when the entire buffer has been filled and the fragment with the *More Fragments* bit set to zero is received, indicating that it is the last fragment of the datagram. The reassembled datagram is then processed like a normal, unfragmented datagram would be. On the other hand, if the timer for the reassembly expires with any of the fragments missing, the message cannot be reconstructed. The fragments are discarded, and an [ICMP Time Exceeded message](#) generated. Since IP is unreliable, it relies on higher layer protocols such as TCP to determine that the message was not properly received and then retransmit it.



IP Datagram Delivery and Routing

The essential functions of IP datagram encapsulation and addressing are sometimes compared to putting a letter in an envelope and then writing the address of the recipient on it. Once our IP datagram “envelope” is filled and labelled, it is ready to go, but it's still sitting on our desk. The last of the main functions of IP is to get the envelope from us to our intended recipient. This is the process of datagram *delivery*. When the recipient is not on our local network, this delivery requires that the datagram be *routed* from our network to the one where the destination resides.

In this section I discuss some of the particulars of how IP routes datagrams over an inter-network. I begin with an overview of the process and contrast direct and indirect delivery of data between devices. I discuss the main method used to route datagrams over the internet, and also explain briefly how IP routing tables are built and maintained. I discuss how the move from “classful” to classless addressing using CIDR impacted routing.



Related Information: Note that this section is brief and focuses mainly on routing issues that are directly related to how IP works. Routing is a complex and important topic in networking, and you'll find much more information about it in [the section that discusses TCP/IP routing/gateway protocols](#). I have tried not to duplicate that section by putting too much information about the process of routing here.

IP Datagram Direct Delivery and Indirect Delivery (Routing)

The overall job of the Internet Protocol is to transmit messages from higher layer protocols over an internetwork of devices. These messages must be packaged and addressed, and if necessary fragmented, and then they must be *delivered*. The process of delivery can be either simple or complex, depending on the proximity of the source and destination devices.

Datagram Delivery Types

Conceptually, we can divide all IP datagram deliveries into two general types, shown graphically in [Figure 91](#):

- ☉ **Direct Datagram Deliveries:** When datagrams are sent between two devices on the same physical network, it is possible for datagrams to be delivered directly from the source to the destination. Imagine that you want to deliver a letter to a neighbor on your street. You probably wouldn't bother mailing it through the post office; you'd just put the neighbor's name on the envelope and stick it right into his or her mailbox.
- ☉ **Indirect Datagram Deliveries:** When two devices are not on the same physical network, the delivery of datagrams from one to the other is *indirect*. Since the source device can't see the destination on its local network, it must send the datagram through one or more intermediate devices to deliver it. Indirect delivery is analogous to

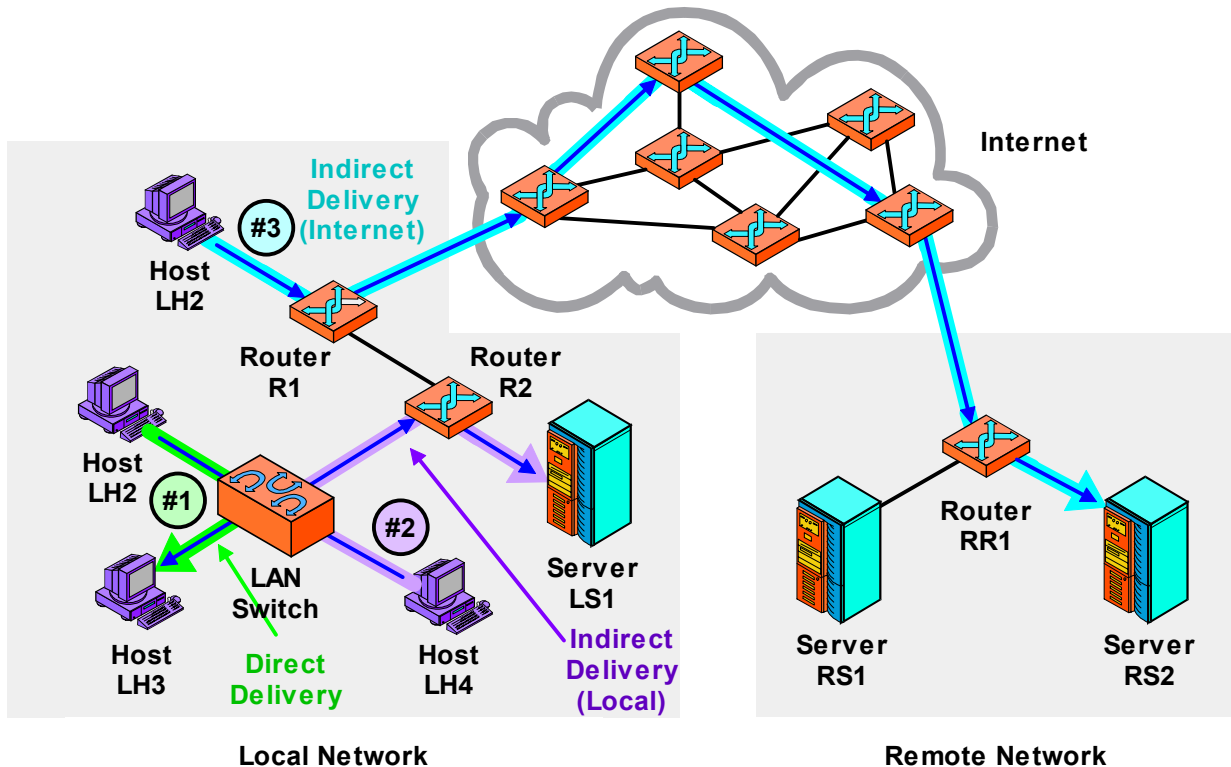

Figure 91: Direct and Indirect (Routed) Delivery of IP Datagrams

This diagram shows three examples of IP datagram delivery. The first transmission (highlighted in green) shows a direct delivery between two devices on the local network. The second (purple) shows indirect delivery within the local network, between a client and server separated by a router. The third shows a more distant indirect delivery, between a client on the local network and a server across the Internet.

mailing a letter to a friend in a different city. You don't deliver it yourself—you put it into the postal system. The letter journeys through postal system, possibly taking several intermediate steps, and ends up in your friend's neighborhood, where a postal carrier puts it into his or her mailbox.

Comparing Direct and Indirect Delivery

Direct delivery is obviously the simpler of these. The source just sends the IP datagram down to its data link layer implementation. The data link layer encapsulates the datagram in a frame that is sent over the physical network directly to the recipient's data link layer, which passes it up to the IP layer.

Indirect delivery is much more complicated, because we can't send the data straight to the recipient. In fact, we usually will not even know where the recipient is, exactly. Sure, we have its address, but we may not know what network it is on, or where that network is relative to our own. (If I told you my address you'd know it's somewhere in Bennington, Vermont, but could you find it?) Like relying on the postal system in the envelope analogy,

we must rely on the internetwork itself to indirectly deliver datagrams. And like the postal system, the power of IP is that you don't need to know how to get the letter to its recipient; you just put it into the system.

The devices that accomplish this “magic” of indirect delivery are generally known as *routers*, and indirect delivery is more commonly called *routing*. Like entrusting a letter to your local mail carrier or mailbox, a host that needs to send to a distant device generally sends datagrams to its local router. The router connects to one or more other routers, and they each maintain information about where to send datagrams so that they reach their final destination.

Indirect delivery is almost always required when communicating with distant devices, such as those on the Internet or across a WAN link. However, it may also be needed even to send to a device in the next room of your office, if that device is not connected directly to yours at layer two.



Note: In the past, routers were often called *gateways*. Today, this term more generally can refer to a device that connects networks in a variety of ways. You will still sometimes hear routers called gateways—especially in the context of terms like “[default gateway](#)”—but since it is ambiguous, the term *router* is preferred.

The Relationship Between Datagram Routing and Addressing

Obviously, each time a datagram must be sent, it is necessary that we determine first of all whether we can deliver it directly or if routing is required. Remember [all those pages and pages of details about IP addressing](#)? Well, this is where the payoff is. The same thing that makes IP addressing sometimes hard to understand—the [division into network ID and host ID bits](#), as well as the [subnet mask](#)—is what allows a device to quickly determine whether or not it is on the same network as its intended recipient:

- ☉ **Conventional “Classful” Addressing:** [We know the class of each address by looking at the first few bits](#). This tells us which bits of an address are the network ID. If the network ID of the destination is the same as our own, the recipient is on the same network; otherwise, it is not.
- ☉ **Subnetted “Classful” Addressing:** [We use our subnet mask to determine our network ID and subnet ID and that of the destination address](#). If the network ID and subnet are the same, the recipient is on the same subnet. If only the network ID is the same, the recipient is on a different subnet of the same network. If the network ID is different, the destination is on a different network entirely.
- ☉ **Classless Addressing:** The same basic technique is used as for subnetted “classful” addressing, except that there are no subnets. [We use the “slash number” to determine what part of the address is the network ID](#) and compare the source and destination as before. There are complications here, however, that I discuss more in [the topic on routing in a classless environment](#).



Key Concept: The delivery of IP datagrams is divided into two categories: *direct* and *indirect*. Direct delivery is possible when two devices are on the same physical network. When they are not, indirect delivery, more commonly called *routing*, is required to get the datagrams from source to destination. A device can tell which type of delivery is required by looking at the IP address of the destination, in conjunction with supplemental information such as the subnet mask that tells the device what network or subnet it is on.

The determination of what type of delivery is required is the first step in the source deciding where to send a datagram. If it realizes the destination is on the same local network it will address the datagram to the recipient directly at the data link layer. Otherwise, it will send the datagram to the data link layer address of one of the routers to which it is connected. The IP address of the datagram will still be that of the ultimate destination. Mapping between IP addresses and data link layer addresses is accomplished using the [TCP/IP Address Resolution Protocol \(ARP\)](#).

I should also clarify one thing regarding the differentiation between direct and indirect delivery. Routing is done in the latter case to get the datagram to the local network of the recipient. After the datagram has been routed to the recipient's physical network, it is sent to the recipient by the recipient's local router. So, you could say that indirect delivery includes direct delivery as its final step.

The next topic discusses IP routing processes and concepts in more detail.



Note: Strictly speaking, any process of delivery between a source and destination device can be considered routing, even if they are on the same network. It is common, however, for the process of routing to refer more specifically to indirect delivery as explained above.

IP Routing Concepts and the Process of Next-Hop Routing

When a datagram is sent between source and destination devices that are not on the same physical network, [the datagram must be delivered indirectly](#) between the devices, a process called *routing*. It is this ability to route information between devices that may be far away that allows IP to create the equivalent of a virtual internetwork that spans potentially thousands of physical networks, and lets devices even on opposite ends of the globe communicate. The process of routing in general terms is too complex to get into in complete detail here, but I do want to take a brief look at key IP routing concepts.

Overview of IP Routing and Hops

To continue with our [postal system analogy](#), I can send a letter from my home in the United States to someone in, say, India, and the postal systems of both countries will work to deliver the letter to its destination. However, when I drop a letter in the mailbox, it's not like someone shows up, grabs the letter, and hand-delivers it to the right address in India. The letter travels from the mailbox to my local post office. From there, it probably goes to a regional distribution center, and then from there, to a hub for international traffic. It goes to India, perhaps (likely) via an intermediate country. When it gets to India, the Indian postal system uses its own network of offices and facilities to route the letter to its destination. The envelope “hops” from one location to the next until it reaches its destination.

IP routing works in very much the same manner. Even though IP lets devices “connect” over the internetwork using indirect delivery, all of the actual communication of datagrams occurs over physical networks using *routers*. We don't know where exactly the destination device's network is, and we certainly don't have any way to connect directly to each of the thousands of networks out there. Instead, we rely on intermediate devices that are each physically connected to each other in a variety of ways to form a mesh containing millions of paths between networks. To get the datagram where it needs to go, it needs to be handed off from one router to the next, until it gets to the physical network of the destination device. The general term for this is *next-hop routing*. The process is illustrated in [Figure 92](#).

The Benefits of Next-Hop Routing

This is a critical concept in how IP works: routing is done on a step-by-step basis, one hop at a time. When we decide to send a datagram to a device on a distant network, we don't know the exact path that the datagram will take; we only have enough information to send it to the correct router to which we are attached. That router, in turn, looks at the IP address of the destination and decides where the datagram should next “hop” to. This process continues until the datagram reaches the destination host's network, when it is delivered.

Next-hop routing may seem at first like a strange way of communicating datagrams over an internetwork. In fact, it is part of what makes IP so powerful. On each step of the journey to any other host, a router only needs to know where the next step for the datagram is. Without this concept, each device and router would need to know what path to take to every other host on the internet, which would be quite impractical.



Key Concept: Indirect delivery of IP datagrams is accomplished using a process called *next-hop routing*, where each message is handed from one router to the next until it reaches the network of the destination. The main advantage of this is that each router needs only to know which neighboring router should be the next recipient of a given datagram, rather than needing to know the exact route to every destination network.

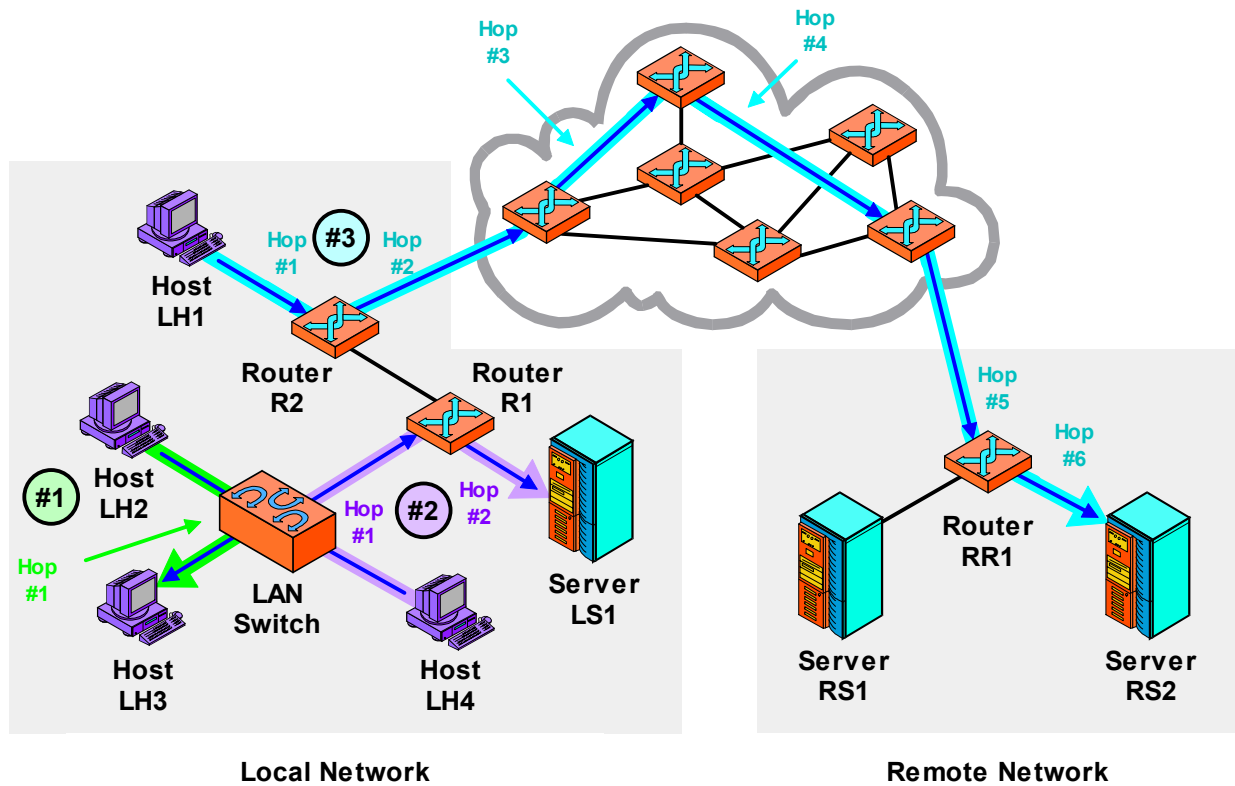

Figure 92: IP Datagram Next-Hop Routing

This is the same diagram as that shown in [Figure 91](#), except this time I have explicitly shown the hops taken by each of the three sample transmissions. The direct delivery of the first (green) transmission has only one hop (remember that the switch doesn't count because it is invisible at layer three). The local indirect delivery passes through one router, so it has two hops. The Internet delivery in this case has six hops; actual Internet routes can be much longer.

Datagram Processing At Each Hop

As mentioned above, each “hop” in routing consists of traversal of a physical network. After a source sends a datagram to its local router, the data link layer on the router passes it up to the router's IP layer. There, the datagram's header is examined, and the router decides what the next device is to send the datagram to. It then passes it back down to the data link layer to be sent over one of the router's physical network links, typically to another router. The router will either have a record of the physical addresses of the routers to which it is connected, or [it will use ARP to determine these addresses](#).

The Essential Role of Routers in IP Datagram Delivery

Another key concept related to the principle of next-hop routing is that routers are designed to accomplish routing, not hosts. Most hosts are connected using only one router to the rest of the internet (or Internet). It would be a maintenance nightmare to have to give each host the smarts to know how to route to every other host. Instead, hosts only decide if they are sending locally to their own network, or if they are sending to a non-local network. If the

latter, they just send the datagram to their router and say “here, **you** take care of this”. If a host has a connection to more than one router, it only needs to know which router to use for certain sets of distant networks. How routers decide what to do with the datagrams when they receive them from hosts is [the subject of the next topic](#).

IP Routes and Routing Tables

Routers are responsible for forwarding traffic on an IP internetwork. Each router accepts datagrams from a variety of sources, examines the IP address of the destination and decides what the [next hop](#) is that the datagram needs to take to get it that much closer to its final destination. A question then naturally arises: how does a router know where to send different datagrams?

Each router maintains a set of information that provides a mapping between different network IDs and the other routers to which it is connected. This information is contained in a data structure normally called a *routing table*. Each entry in the table, unsurprisingly called a *routing entry*, provides information about one network (or subnet, or host). It basically says “if the destination of this datagram is in the following network, the next hop you should take is to the following device”. Each time a datagram is received the router checks its destination IP address against the routing entries in its table to decide where to send the datagram, and then sends it on its next hop.

Obviously, the fewer the entries in this table, the faster the router can decide what to do with datagrams. (This was a big part of the motivation for [classless addressing](#), which aggregates routes into “supernets” to reduce router table size, [as we will see in the next topic](#).) Some routers only have connections to two other devices, so they don't have much of a decision to make. Typically, the router will simply take datagrams coming from one of its interfaces and if necessary, send them out on the other one. For example, consider a small company's router acting as the interface between a network of three hosts and the Internet. Any datagrams sent to the router from a host on this network will need to go over the router's connection to the router at the ISP.

When a router has connections to more than two devices, things become considerably more complex. Some distant networks may be more easily reachable if datagrams are sent using one of the routers than the other. The routing table contains information not only about the networks directly connected to the router, but also information that the router has “learned” about more distant networks.



Key Concept: A router make decisions about how to route datagrams using its internal *routing table*. The table contains entries specifying to which router datagrams should be sent to reach a particular network.

Routing Tables in an Example Internetwork

Let's consider an example (see Figure 93) with routers R1, R2 and R3 connected in a "triangle", so that each router can send directly to the others, as well as to its own local network. Suppose R1's local network is 11.0.0.0/8, R2's is 12.0.0.0/8 and R3's is 13.0.0.0/8. (I'm just trying to keep this simple. ☺) R1 knows that any datagram it sees with 11 as the first octet is on its local network. It will also have a routing entry that says that any IP address starting with "12" should go to R2, and any starting with "13" should go to R3.

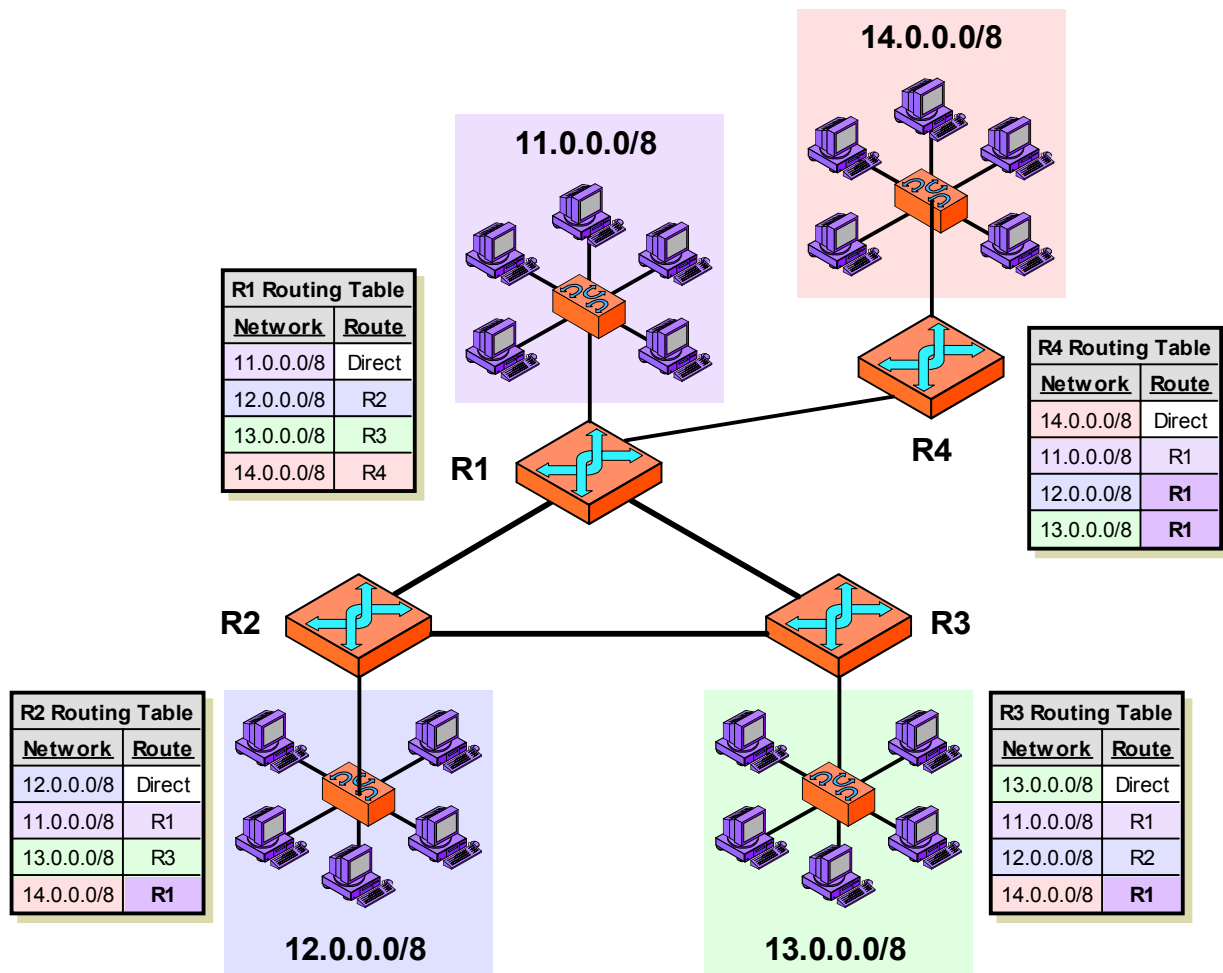

Figure 93: IP Routing and Routing Tables

This diagram shows a small, simple internetwork consisting of four LANs each served by a router. The routing table for each lists the router to which datagrams for each destination network should be sent, and is color coded to match the colors of the networks. Notice that due to the "triangle", each of R1, R2 and R3 can send to each other. However, R2 and R3 must send through R1 to deliver to R4, and R4 must use R1 to reach either of the others.

Let's suppose that R1 also connects to another router, R4, which has 14.0.0.0/8 as its local network. R1 will have an entry for this local network. However, R2 and R3 also need to know how to reach 14.0.0.0/8, even though they don't connect to it its router directly. Most

likely, they will have an entry that says that any datagrams intended for 14.0.0.0/8 should be sent to R1. R1 will then forward them to R4. Similarly, R4 will send any traffic intended for 12.0.0.0/8 or 13.0.0.0/8 through R1.

Route Determination

Now, imagine that this process is expanded to handle thousands of networks and routers. Not only do routers need to know which of their local connections to use for each network, they want to know, if possible, what is the **best** connection to use for each network. Since routers are interconnected in a mesh there are usually multiple routes between any two devices, but we want to take the best route whenever we can. This may be the shortest route, the least congested, or the route considered optimal based on other criteria.

Determining what routes we should use for different networks turns out to be an important but very complex job. Routers must plan routes and exchange information about routes and networks, which can be done in a variety of ways. This is accomplished in IP using special IP *routing protocols*. It is through these protocols that R2 and R3 would find out that 14.0.0.0/8 exists and that it is connected to them via R1. I discuss these important “support protocols” in their own section.



Note: There is a difference between a **routeable** protocol and a **routing** protocol. IP is a *routeable* protocol, which means its messages (datagrams) can be routed. Examples of *routing* protocols are [RIP](#) or [BGP](#), which are used to exchange routing information between routers.

IP Routing In A Subnet Or Classless Addressing (CIDR) Environment

There are three main categories of IP addressing: “classful”, subnetted “classful”, and classless. [As we have already seen](#), the method used for determining whether direct or indirect delivery of a datagram is required is different for each type of addressing. The type of addressing used in the network also impacts how routers decide to forward traffic in an internet.

One of the main reasons why the traditional class-based addressing scheme was created was that it made both addressing and routing relatively simple. We must remember that IPv4 was developed in the late 1970s, when the cheap and powerful computer hardware we take for granted today was still in the realm of science fiction. For the internetwork to function properly, routers had to be able to look at an IP address and quickly decide what to do with it.

“Classful” addressing was intended to make this possible. There was only a two-level hierarchy for the entire internet: network ID and host ID. [Routers could tell by looking at the first four bits](#) which of the bits in any IP address were the network ID and which the host ID. Then they needed only consult their routing tables to find the network ID and see which router was the best route to that network.

The addition of subnetting to conventional addressing didn't really change this for the main routers on the internet, because subnetting is internal to the organization. The main routers handling large volumes of traffic on the Internet didn't look at subnets at all; the additional level of hierarchy that subnets represent existed only for the routers within each organization that chose to use subnetting. These routers, when deciding what to do with datagrams within the organization's network, had to extract not only the network ID of IP addresses, but also the subnet ID. This told them which internal physical network to send the datagram to.

Aggregated Routes and their Impact on Routing

Classless addressing is formally called *Classless Inter-Domain Routing* or *CIDR*. The name mentions routing and not addressing, and this is evidence that CIDR was introduced in large part to improve the efficiency of routing. This improvement occurs because classless networks use a multiple-level hierarchy. Each network can be broken down into subnetworks, sub-subnetworks, and so on. This means that when we are deciding how to route in a CIDR environment, we can also describe routes in a hierarchical manner. Many smaller networks can be described using a single, higher-level network description that represents them all to routers in the rest of the internet. This technique, sometimes called *route aggregation*, reduces routing table size.

Let's refer back to [the detailed example I gave in the addressing section on CIDR](#). An ISP started with the block 71.94.0.0/15 and subdivided it multiple times to create smaller blocks for itself and its customers. To the customers and users of this block, these smaller blocks must be differentiated; the ISP obviously needs to know how to route traffic to the correct customer. To everyone else on the Internet, however, these details are unimportant in deciding how to route datagrams to anyone in that ISP's block. For example, suppose I am using a host with IP address 211.42.113.5 and I need to send to 71.94.1.43. My local router, and the main routers on the Internet, don't know where in the 71.94.0.0/15 block that address is, and they don't need to know either. They just know that anything with the first 15 bits containing the binary equivalent of 71.94 goes to the router(s) that handle(s) 71.94.0.0/15, which is the aggregated address of the entire block. They let the ISP's routers figure out which of its constituent subnetworks contains 71.94.1.43.

Contrast this to the way it would be in a "classful" environment. Each of the customers of this ISP would probably have one or more Class C address blocks. Each of these would require a separate router entry, and these blocks would have to be known by *all* routers on the Internet. Thus, instead of just one 71.94.0.0/15 entry, there would be dozens or even hundreds of entries for each customer network. In the classless scheme, only one entry exists, for the "parent" ISP.

Potential Ambiguities in Classless Routes

CIDR provides benefits to routing but also increases complexity. Under CIDR, we cannot determine which bits are the network ID and which the host ID just from the IP address. To make matters worse, we can have networks, subnetworks, sub-subnetworks and so on that all have the same base address!

In our example above, 71.94.0.0/15 is the complete network, and subnetwork #0 is 71.94.0.0/16. They have a different prefix length (the number of network ID bits) but the same base address. If a router has more than one match for a network ID in this manner, it must use the match with the longest network identifier first, since it represents a more specific network description.



IP Multicasting

The great bulk of TCP/IP communications uses the Internet Protocol to send messages from one source device to one recipient device; this is called *unicast* communications. This is the type of messaging we normally use TCP/IP for; when you use the Internet you are using unicast for pretty much everything. For this reason, most of my discussion of IP has been oriented around describing [unicast messaging](#).

IP does, however, also support the ability to have one device send a message to a set of recipients. This is called *multicasting*. IP multicasting has been “officially” supported since IPv4 was first defined, but has not seen widespread use over the years, due largely to lack of support for multicasting in many hardware devices. Interest in multicasting has increased in recent years, and support for multicasting was made a standard part of the [next generation IP version 6 protocol](#). Therefore, I felt it worthwhile to provide a brief overview of IP multicasting. It's a large and very complex subject, so I will not be getting into it in detail—you'll have to look elsewhere for a full description of IP multicasting. (Sorry, it was either a brief summary or nothing; maybe I'll write more on multicasting in the future.)

The idea behind IP multicasting is to allow a device on an IP internetwork to send datagrams not to just one recipient but to an arbitrary collection of other devices. IP multicasting is modeled after the similar function used in the data link layer to allow a single hardware device to send to various members of a group. Multicasting is relatively easy at the data link layer, however, because all the devices can communicate directly. In contrast, at the network layer, we are connecting together devices that may be quite far away from each other, and must route datagrams between these different networks. This necessarily complicates multicasting when done using IP (except in the special case where we use IP multicasting only between devices on the same data link layer network.)

There are three primary functions that must be performed to implement IP multicasting: addressing, group management, and datagram processing / routing.

Multicast Addressing

Special addressing must be used for multicasting. These *multicast addresses* identify not single devices but rather *multicast groups* of devices that listen for certain datagrams sent to them. In IPv4, 1/16th of the entire address space was set aside for multicast addresses: the Class D block of the original “[classful](#)” [addressing scheme](#).

Special techniques are used to define the meaning of addresses within this block, and to define a mapping between IP multicast and data link layer multicast addresses. This is all described in [the topic on IP multicast addressing](#); mapping of IP multicast addresses to hardware layer multicast addresses is discussed [in the section on address resolution](#).

Multicast Group Management

Group management encompasses all of the activities required to set up groups of devices. They must be able to dynamically join groups and leave groups, and information about groups must be propagated around the IP internetwork. To support these activities,

additional techniques are required. The *Internet Group Management Protocol (IGMP)* is the chief tool used for this purpose. It defines a message format to allow information about groups and group membership to be sent between devices and routers on the internet.

Multicast Datagram Processing and Routing

This is probably the most complicated: handling and routing datagrams in a multicast environment. There are several issues here:

- ☉ Since we are sending from one device to many devices, we need to actually create multiple copies of the datagram for delivery, in contrast to the single datagram used in the unicast case. Routers must be able to tell when they need to create these copies.
- ☉ Routers must use special algorithms to determine how to forward multicast datagrams. Since each one can lead to many copies being sent various places, efficiency is important to avoid creating unnecessary volumes of traffic.
- ☉ Routers must be able to handle datagrams sent to a multicast group even if the source is not a group member.

Routing in a multicast environment requires significantly more intelligence on the part of router hardware. Several special protocols, such as the *Distance Vector Multicast Routing Protocol (DVMRP)*, and the multicast version of [OSPF](#), are used to enable routers to forward multicast traffic effectively. These algorithms must balance the need to ensure that every device in a group receives a copy of all datagrams intended for that group, with the need to prevent unnecessary traffic from moving across the internetwork.



Key Concept: IP multicasting allows special applications to be developed where one device sends information to more than one other, across a private internet or the global Internet. It is more complex than conventional unicast IP and requires special attention particularly in the areas of addressing and routing.

This overview has only scratched the surface of IP multicasting. The complexity involved in handling groups and forwarding messages to multicast groups is one reason why support for the feature has been quite uneven and as a consequence, it is not used widely. Another issue is the demanding nature of multicasting; it uses a great deal of network bandwidth for copies of messages, and also requires more work of already-busy routers.



Internet Protocol Version 6 (IPv6) / IP Next Generation (IPng)

Since 1981, TCP/IP has been built on [version 4 of the Internet Protocol](#). IPv4 was created when the giant, world-wide Internet we take for granted today was just a small experimental network. Considering how much the Internet has grown and changed over the course of two decades, IPv4 has done its job admirably. At the same time, it has been apparent for many years that certain limitations in this venerable protocol would hold back the future growth of both Internet size and services if not addressed.

Due to the key role that IP plays, changing it is no simple feat. It means a substantial modification to the way that nearly everything in TCP/IP operates. However, even though we find change difficult, most of us know that it is necessary. For the last several years, development of a new version of IP has been underway, officially called *Internet Protocol version 6 (IPv6)* and also sometimes referred to as *IP Next Generation* or *IPng*. IPv6 is poised to take over from IPv4, and will be the basis for the Internet of the future.

In this section I provide a detailed description of IP version 6. Since IPv6 is still IP just like IPv4, it performs the same functions: addressing, encapsulation, fragmentation and reassembly, and datagram delivery and routing. For this reason, the subsections and topics in this discussion of IPv6 are patterned after the subsections in the section on IPv4. They include a discussion of IPv6 concepts and issues, coverage of IPv6 addressing and data packaging, and a look at how version 6 does fragmentation, reassembly and routing.



Background Information: Since IPv6 represents the evolution of IP, many of its concepts of operation are built upon those introduced in IPv4. To avoid unnecessary duplication, this section has been written with the assumption that the reader is familiar with the operation of IPv4, especially addressing and how datagrams are packaged and delivered. If you have not read [the section on IPv4](#), reviewing it first would be wise, because the description of IPv6 focuses on how it differs from the current IP version.



Related Information: You may wish to refer to the sections on [ICMP](#) (part of which is ICMPv6—ICMP for IPv6) and the [IPv6 Neighbor Discovery \(ND\) protocol](#), since these are “companions” of sort to IPv6. However, it is not necessary.



Note: IPv6 is obviously still under development, and as such, writing a section such as this one is like trying to hit a moving target. This is probably why most TCP/IP guides don't say much about IPv6—it keeps changing! I think it is important, so I have described it as defined on the date of publishing. However, since changes are being made to both IPv6 standards and implementation every month, there is a higher probability of information in this particular section being out of date. (I had to make several revisions even prior to publishing the first version of this Guide!)

IPv6 Overview, Changes and Transition

IPv6 is destined to be the future of the Internet Protocol, and due to IP's critical importance, it will form the basis for the future of TCP/IP and the Internet as well. In fact, it's been under development since the middle of the last decade, and a real IPv6 internetwork has been used for testing for a number of years as well. Despite this, many people don't know much about IPv6, other than it's a newer version of IP. Some have never even heard of it at all! We're going to rectify that, of course—but before we delve into the important changes made in version 6 to how IP addressing, packaging, fragmentation and other functions, let's start with a “bird's eye” view of IPv6.

In this section I provide a brief higher-level overview of IPv6, including a look at how it differs from IPv4 in general terms. I begin with a brief overview of IPv6 and why it was created. I list the major changes made in IPv6 and additions to the protocol from the current version. I also explain some of the difficulties associated with transitioning the enormous global Internet from IPv4 to IPv6.

IPv6 Motivation and Overview

“If it ain't broke, don't fix it.” I consider this one of my favorite pieces of folk wisdom. I generally like to stick with what works, as do most people. And [IP version 4](#) works pretty darned well. It's been around for decades now and has survived the growth of the Internet from a small research network into a globe-spanning powerhouse. So, like a trusty older car that we've operated successfully for years, why should we replace it if it still gets the job done?

Like that older car, we could continue to use IPv4 for the foreseeable future. The question is: *at what cost?* An older car can be kept in good working order if you are willing to devote the time and money it takes to maintain and service it. However, it will still be limited in some of its capabilities. Its reliability may be suspect. It won't have the latest features. With the exception of those who like to work on cars as a hobby, it eventually stops making sense to keep fixing up an older vehicle.

In some ways, this isn't even that great of an analogy. Our highways aren't all that much different than they were in the 1970s, and most other issues related to driving a car haven't changed all that much in the last 25 years either. The choice of updating a vehicle or not is based on practical considerations more than necessity.

In contrast, look at what has happened to the computer and networking worlds in the last 25 years! Today's handheld PCs can do more than the most powerful servers could back then. Networking technologies are 100 or even 1000 times as fast. The number of people connecting to the global Internet has increased by an even larger factor. And the ways that computers communicate have, in many cases, changed dramatically.

IPv4 could be considered in some ways like an older car that has been meticulously maintained and repaired over time. It gets the job done, but its age is starting to show. The main problem with IPv4 is its relatively small [address space](#), a legacy of the decision to use only 32 bits for the IP address. Under the original “classful” addressing allocation scheme,

we would have probably already run out of IPv4 addresses by now. Moving to [classless addressing](#) has helped postpone this, as have technologies like [IP Network Address Translation \(NAT\)](#) that allow privately-addressed hosts to access the Internet.

In the end, however, these represent patch jobs and imperfect repairs applied to keep the aging automobile that is IPv4 on the road. The core problem, the 32-bit address space that is too small for the current and future size of the Internet, can only be addressed by moving to a larger address space. This was the primary motivating factor in creating the next version of the Internet Protocol, *IPv6*.



Note: The reason why the successor to IPv4 is version 6 and not version 5 is because version number 5 was used to refer to an experimental protocol called the *Internet Stream Protocol*, which was never widely deployed. [See the topic on IP history and versions for a full discussion.](#)

IPv6 Standards

IPv6 represents the first major change to the Internet Protocol since IPv4 was formalized in 1981. For many years, its core operation was defined in a series of RFCs published in 1998, RFCs 2460 through 2467. The most notable of these are the main IPv6 standard, RFC 2460 ([Internet Protocol, Version 6 \(IPv6\) Specification](#)), and documents describing the two “helper” protocols for IPv6: RFC 2461, which describes the [IPv6 Neighbor Discovery Protocol](#), and RFC 2463, which describes [ICMP version 6 \(ICMPv6\)](#) for IPv6.

In addition to these, two documents were also created in 1998 to discuss more about IP addressing: RFC 2373 ([IP Version 6 Addressing Architecture](#)) and RFC 2374 ([An IPv6 Aggregatable Global Unicast Address Format](#)). Due to changes in how IPv6 addressing was to be implemented, these were updated in 2003 by RFC 3513 ([Internet Protocol Version 6 \(IPv6\) Addressing Architecture](#)) and RFC 3587 ([IPv6 Global Unicast Address Format](#)).

Many other RFCs define more specifics of how IPv6 functions, and also describe IPv6-compatible versions of other TCP/IP protocols like [DNS](#) and [DHCP](#). IPv6 is still very much a work in progress with new standards for it being proposed and adopted on a regular basis.

Since IPv6 is the version of IP designed for the next generation of the Internet, it is also sometimes called *IP Next Generation* or *IPng*. Personally, I don't care for this name; it reminds me too much of *Star Trek: The Next Generation*. A great show that my wife and I watch regularly, but still. Regardless of its name, IPv6 or IPng was designed to take TCP/IP and the Internet “where none have gone before”. (Sorry, I **had** to! ☺)

Design Goals of IPv6

The problem of addressing was the main motivation for creating IPv6. Unfortunately, this has caused many people to think that the address space expansion is the **only** change made in IP, which is definitely not the case. Since making a change to IP is such a big deal,

it's something done rarely. It made sense to correct not just the addressing issue but to update the protocol in a number of other respects as well, to ensure its viability. In fact, even the addressing changes in IPv6 go far beyond just adding more bits to IP address fields.

Some of the most important goals in designing IPv6 include:

- ① **Larger Address Space:** This is what we discussed earlier. IPv6 had to provide more addresses for the growing Internet.
- ② **Better Management of Address Space:** It was desired that IPv6 not only include more addresses, but a more capable way of dividing the address space and using the bits in each address.
- ③ **Elimination of “Addressing Kludges”:** Technologies like [NAT](#) are effectively “kludges” that make up for the lack of address space in IPv4. IPv6 eliminates the need for NAT and similar workarounds, allowing every TCP/IP device to have a public address.
- ④ **Easier TCP/IP Administration:** The designers of IPv6 hoped to resolve some of the current labor-intensive requirements of IPv4, such as the need to configure IP addresses. Even though tools like DHCP eliminate the need to manually configure many hosts, it only partially solves the problem.
- ⑤ **Modern Design For Routing:** In contrast to IPv4, which was designed before we all had any idea what the modern Internet would be like, IPv6 was created specifically for efficient routing in our current Internet, and with the flexibility for the future.
- ⑥ **Better Support For Multicasting:** Multicasting was an option under IPv4 from the start, but support for it has been slow in coming.
- ⑦ **Better Support For Security:** IPv4 was designed at a time when security wasn't much of an issue, because there were a relatively small number of networks on the internet, and their administrators often knew each other. Today, security on the public Internet is a big issue, and the future success of the Internet requires that security concerns be resolved.
- ⑧ **Better Support For Mobility:** When IPv4 was created, there really was no concept of mobile IP devices. The problems associated with computers that move between networks led to the need for [Mobile IP](#). IPv6 builds on Mobile IP and provides mobility support within IP itself.

IPv6: The Evolution of IP

At the same time that IPv6 was intended to address the issues above and many others with traditional IP, we should keep in mind that its changes are *evolutionary*, not *revolutionary*. During the many discussions in the IETF in the 1990s, there were some who said that while we were updating IP, perhaps we should make a complete, radical change to a new type of internetworking protocol completely. The end decision was not to do this, but to define a more capable version of the IP we've been using all along.

The reason for this is simple: IP, like our trusted older car, **works**. IPv6 represents an update that strives to add to the best characteristics of IPv4 rather than making everyone start over from scratch with something new and unproven. This design ensures that whatever pain may result from the change from IPv4 to IPv6 can be managed, and hopefully, minimized.



Key Concept: The new version of the Internet Protocol is *Internet Protocol Version 6 (IPv6)*. It was created to correct some of the significant problems of IPv4, especially the looming exhaustion of the IPv4 address space, and to improve the operation of the protocol as a whole, to take TCP/IP in to the future.

Major Changes And Additions In IPv6

In the [preceding overview](#), I explained that the primary motivator for creating a new version of IP was to fix the problems with addressing under IPv4. But as we also saw there, numerous other design goals existed for the new protocol as well. Once the decision was made to take the significant step of creating a new version of a protocol as important as IP, it made sense to use the opportunity to make as many improvements as possible.

Of course, there is still the problem of the pain of change to worry about, so each potential change or addition in IPv6 had to have benefits that would outweigh its costs. The resulting design does a good job of providing useful advantages while maintaining most of the core of the original Internet Protocol. The following list provides a summary of the most important changes between IPv4 and IPv6, showing some of the ways that the IPv6 team met the design goals for the new protocol:

- **Larger Address Space:** [IPv6 addresses are 128 bits](#) long instead of 32 bits. This expands the address space from around 4 billion addresses to, well, an astronomic number (over 300 trillion trillion trillion addresses).
- **Hierarchical Address Space:** One reason why the IPv6 address size was expanded so much was to allow it to be [hierarchically divided](#) to provide a large number of each of many classes of addresses.
- **Hierarchical Assignment of Unicast Addresses:** A special [global unicast address format](#) was created to allow addresses to be easily allocated across the entire Internet. It allows for multiple levels of network and subnetwork hierarchies both at the ISP and organizational level. It also permits [generating IP addresses based on underlying hardware interface device IDs](#) such as Ethernet MAC addresses.
- **Better Support for Non-Unicast Addressing:** [Support for multicasting is improved](#), and support is added for a new type of addressing: *anycast* addressing. This new kind of addressing basically says “deliver this message to the easiest-to-reach member of this group”, and potentially enables new types of messaging functionality.
- **Autoconfiguration and Renumbering:** A provision is included to allow easier [autoconfiguration of hosts and renumbering of the IP addresses in networks and subnetworks](#) as needed. A technique also exists for renumbering router addresses.

-
- **New Datagram Format:** The IP datagram format has been redefined and given new capabilities. The main header of each IP datagram has been streamlined, and support added for easily [extending the header](#) for datagrams requiring more control information.
 - **Support for Quality of Service:** IPv6 datagrams include QoS features, allowing better support for multimedia and other applications requiring quality of service.
 - **Security Support:** Security support is designed into IPv6 using the [authentication and encryption extension headers](#) and other features.
 - **Updated Fragmentation and Reassembly Procedures:** The way that [fragmentation and reassembly of datagrams](#) works has been changed in IPv6, to improve efficiency of routing and better reflect the realities of today's networks.
 - **Modernized Routing Support:** The IPv6 protocol is designed to support modern [routing systems](#), and to allow expansion as the Internet grows.
 - **Transition Capabilities:** Since it was recognized from the start that going from IPv4 to IPv6 is a big move, support for the IPv4/IPv6 transition has been provided in numerous areas. This includes [a plan for interoperating IPv4 and IPv6 networks](#), [mapping between IPv4 and IPv6 addresses](#) and more.

The rest of the sections on IPv6 provide much more detail on these changes and additions to IP. You'll notice that the majority of these are related to addressing, since that is where the greatest number of important changes have been made in IPv6. Of course, routing and addressing are closely related, and the changes to addressing has had a big impact on routing as well.

Another change that I should mention is that with the introduction of IPv6, several other TCP/IP protocols that deal intimately with IP have also had to be updated. One of these is [ICMP](#), the most important support protocol for IPv4, which has been revised through the creation of ICMPv6 for IPv6. An addition to TCP/IP is the [Neighbor Discovery \(ND\) protocol](#), which performs several functions for IPv6 that were done by [ARP](#) and ICMP in version 4.

Transition from IPv4 to IPv6

The Internet Protocol is the foundation of the TCP/IP protocol suite and the Internet, and thus somewhat comparable to the foundation of a house in terms of its structural importance. Given this, changing IP is somewhat analogous to making a substantial modification to the foundation of your house. Since IP is used to connect together many devices, it is in fact, like changing not just your house, but every house in the world!

How do you change the foundation of a house? Very carefully. The same caution is required with the implementation of IPv6. While to most people IPv6 is something “new”, the reality is that the planning and development of IPv6 has been underway for nearly a full decade, and if we were starting from scratch the protocol would have been ready for action years ago. However, there is a truly enormous installed base of IPv4 hardware and software. This means the folks who develop TCP/IP could not just “flip a switch” and have everyone move over to using IPv6. Instead, a *transition* from IPv4 to IPv6 had to be planned.

IPv4-IPv6 Transition: Differences of Opinion

The transition is already underway, though most people don't know about it. As I said, development of IPv6 itself is pretty much complete, though work continues on refining the protocol and also on development of IPv6-compatible versions of other protocols. The implementation of IPv6 began with the creation of development networks to test IPv6's operation. These were connected together to form an experimental IPv6 internetwork called the *6BONE* (which is a contraction of the phrase "IPv6 backbone".) This internetwork has been in operation for several years.

Experimental networks are well and good, but of course the big issue is transitioning the "real" Internet to IPv6—and here, opinion diverges rather quickly. In one camp are the corporations, organizations and individuals who are quite eager to transition to IPv6 quickly, to gain the many benefits it promises in the areas of addressing, routing and security. Others are taking a much more cautious approach, noting that the dire predictions in the mid-1990s of IPv4's imminent doom have not come to pass, and arguing that we should take our time to make sure IPv6 is going to work on a large scale.

These two groups will continue to play tug-of-war for the next few years, but it seems that the tide is now turning towards those who want to speed up the now-years-long transition. The move towards adoption of IPv6 as a *production* protocol is being spearheaded by a number of groups and organizations. IPv6 has a lot of support in areas outside the United States, many of which are running short of IPv4 addresses due to small allocations relative to their size. One such area is Asia, a region with billions of people, rapidly-growing Internet use and a shortage of IPv4 addresses.

Within the United States, which has the lion's share of IPv4 addresses (due to the Internet having been developed in the U.S.A.), there seems to be a bit less enthusiasm for rapid IPv6 deployment. Even here, however, IPv6 got a major "shot in the arm" in July 2003 when the United States Department of Defense (DoD) announced that starting in October of that year, it would only purchase networking products that included compatibility with IPv6. The DoD—which of course was [responsible for the development of the Internet in the first place](#)—hopes to be fully transitioned to IPv6 by 2008. This will likely have a big impact on the plans of other governmental and private organizations in the United States.

Of course, the creators of IPv6 knew from the start that transition was going to be an important issue with the new protocol. IPv6 is not compatible with IPv4 because the addressing system and datagram format are different. Yet the IPv6 designers knew that since the transition would take many years, it was necessary that they provide a way for IPv4 and IPv6 hosts to interoperate. Consider that in any transition there are always "stragglers". Like the old Windows 3.11 PC in the corner that you still need to use once in a while, even when most of the Internet is IPv6 there will still likely be some devices that are still on IPv4 because they were never upgraded.



Key Concept: Due to the many differences between IPv4 and IPv6, and the fundamental importance of the Internet Protocol to TCP/IP, an orderly *transition* has been planned from IPv4 to IPv6 over a period of many years.

IPv4-IPv6 Transition Methods

Due to the time that change takes, IETF has been working on specific provisions to allow a smooth transition from version 4 to version 6, and hardware and software interoperability solutions to let newer IPv6 devices access IPv4 hosts. A technique was included in IPv6 to allow administrators to [embed IPv4 addresses within IPv6 addresses](#). Special methods are defined to handle interoperability, including:

- ☉ **“Dual Stack” Devices:** Routers and some other devices may be programmed with both IPv4 and IPv6 implementations to allow them to communicate with both types of hosts.
- ☉ **IPv4/IPv6 Translation:** “Dual stack” devices may be designed to accept requests from IPv6 hosts, convert them to IPv4 datagrams, send the datagrams to the IPv4 destination and then process the return datagrams similarly.
- ☉ **IPv4 Tunneling of IPv6:** IPv6 devices that don’t have a path between them consisting entirely of IPv6-capable routers may be able to communicate by encapsulating IPv6 datagrams within IPv4. In essence, they would be using IPv6 on top of IPv4; two network layers. The encapsulated IPv4 datagrams would travel across conventional IPv4 routers.

Bear in mind that these solutions generally only address backward compatibility, to allow IPv6 devices to talk to IPv4 hardware. Forward compatibility between IPv4 and IPv6 is not possible because IPv4 hosts cannot communicate with IPv6 hosts—they lack the knowledge of how IPv6 works. It is possible that certain special adaptations might be created to allow IPv4 hosts to access IPv6 hosts. But eventually, all IPv4 devices of any importance will want to migrate to IPv6.

The IETF has done such a good job in the past with introducing new technologies, and so much effort has been put into the IPv6 transition, that I am quite confident that the transition to IPv6 will come off with few, if any, problems. One good thing about the transition is that IPv4 is, at the present time, still getting the job done, so there is no big hurry to make the move to version 6. While technologies such as CIDR and NAT are “band-aids” on IPv4, they have been very successful ones in extending the useful life of the aging protocol.



IPv6 Addressing

The primary motivation for creating IPv6 was to rectify the [addressing problems in IPv4](#). More addresses were required, but more than this, the IPv6 designers desired a way of interpreting, assigning and using them that was more consonant with modern internet-working. Based on this, it's no surprise that many of the changes in IPv6 are associated with IP addressing. The IPv6 addressing scheme is similar in general concept to IPv4 addressing, but has been completely overhauled to create an addressing system capable of supporting continued Internet expansion and new applications for the foreseeable future.

This section describes the concepts and methods associated with addressing under IPv6. I begin with a look at some addressing generalities in version 6, including the addressing model, address types size and address space. I discuss the unique and sometimes confusing representations and notations used for IPv6 addresses and prefixes. Then I look at how addresses are arranged and allocated into types, beginning with an overall look at address space composition and then the global unicast address format. I describe the new methods used for mapping IP addresses to underlying physical network addresses. I then describe special IPv6 addressing issues, including reserved and private addresses, IPv4 address embedding, anycast and multicast addresses, and autoconfiguration and renumbering of addresses.

Addressing under IPv6 is outlined in the main IPv6 RFC, RFC 2460 ([Internet Protocol Version 6 \(IPv6\) Specification](#)). However, most of the details of IPv6 addressing are contained in two other standards: RFC 3513 ([Internet Protocol Version 6 \(IPv6\) Addressing Architecture](#)) and RFC 3587 ([IPv6 Global Unicast Address Format](#)). These replaced the 1998 standards RFC 2373 ([IP Version 6 Addressing Architecture](#)) and RFC 2374 ([An IPv6 Aggregatable Global Unicast Address Format](#)).



Background Information: As with the other IPv6 sections in this Guide, our look at addressing is based somewhat on a contrast to how addressing is done in IPv4. I strongly recommend a thorough understanding of [IPv4 addressing](#), including [classless addressing using CIDR](#), before proceeding here. As with the IPv4 addressing sections, familiarity with how binary numbers work, and conversion between binary and decimal numbers is also a good idea. [The background section on data representation and the mathematics of computing](#) may be of assistance in that respect.

IPv6 Addressing Overview: Addressing Model and Address Types

In the [IPv6 overview section](#) I explained that IPv6 represents a significant update to the Internet Protocol, but that its modifications and additions are made without changing the core nature of how IP works. Addressing is the place where most of the differences between IPv4 and IPv6 are seen, but the changes are mostly in how addresses are implemented and used. The overall model used for IP addressing in IPv6 is pretty much the same as it was in IPv4; some aspects have not changed at all, while others have changed only slightly.

Unchanged Aspects of Addressing in IPv6

Some of the general characteristics of the IPv6 addressing model that are basically the same as in IPv4:

- ④ **Core Functions of Addressing:** The two main functions of addressing are still [network interface identification and routing](#). Routing is facilitated through the structure of addresses on the internetwork.
- ④ **Network Layer Addressing:** IPv6 addresses are still the ones associated with the network layer in TCP/IP networks, and are distinct from data link layer (also sometimes called *physical*) addresses.
- ④ **Number of IP Addresses Per Device:** [Addresses are still assigned to network interfaces](#), so a regular host like a PC will usually have one (unicast) address, and routers will have more than one, for each of the physical networks to which it connects.
- ④ **Address Interpretation and Prefix Representation:** IPv6 addresses are like classless IPv4 addresses in that they are interpreted as having a network identifier part and a host identifier part, but that the delineation is not encoded into the address itself. A prefix length number, using [CIDR-like notation](#), is used to indicate the length of the network ID (prefix length).
- ④ **Private and Public Addresses:** Both types of addresses exist in IPv6, though they are defined and used somewhat differently.

IPv6 Address Types

One important change in the addressing model of IPv6 is the *address types* supported. IPv4 supported three address types: unicast, multicast and broadcast. Of these, the vast majority of actual traffic was unicast. [IP multicast](#) support was not widely deployed until many years after the Internet was established, and continues to be hampered by various issues. Use of broadcast in IP had to be severely restricted for performance reasons (we don't want any device to be able to broadcast across the entire Internet!)

IPv6 also supports three address types, but with some changes:

- ④ **Unicast Addresses:** These are standard unicast addresses as in IPv4, one per host interface.
- ④ **Multicast Addresses:** These are addresses that represent various groups of IP devices: a message sent to a multicast address goes to all devices in the group. IPv6 includes much better multicast features and many more multicast addresses than IPv4. Since multicast under IPv4 was hampered in large part due to lack of support of the feature by many hardware devices, support for multicasting is a required, not optional, part of IPv6.
- ④ **Anycast Addresses:** Anycast addressing is used when a message must be sent to any member of a group, but does not need to be sent to them all. Usually the member of the group that is easiest to reach will be sent the message. One common example of how anycast addressing could be used is in load sharing amongst a group of routers in an organization.



Key Concept: IPv6 has unicast and multicast addresses like IPv4. There is, however, no distinct concept of a broadcast address in IPv6. A new type of address, the *anycast* address, has been added to allow a message to be sent to any one member of a group of devices.

Implications of the Changes to Address Types in IPv6

Broadcast addressing as a distinct addressing method is gone in IPv6. Broadcast functionality is implemented using multicast addressing to groups of devices. A multicast group to which all nodes belong can be used for broadcasting in a network, for example.

An important implication of the creation of anycast addressing is removal of the strict uniqueness requirement for IP addresses. Anycast is accomplished by assigning the same IP address to more than one device. The devices must also be specifically told that they are sharing an anycast address, but the addresses themselves are structurally the same as unicast addresses.

The bulk of the remainder of this section focuses on unicast addressing, since it is by far the most important type. [Multicast and anycast addressing are given special attention separately.](#)

IPv6 Address Size and Address Space

Of all the changes introduced in IPv6, easily the most “celebrated” is the increase in the size of IP addresses, and as a result, the increase in the size of the address space as well. It's not surprising that these sizes were increased compared to IPv4—everyone has known for years that the IPv4 address space was too small to support the future of the Internet. What's remarkable is just how much the increase is, and what the implications are for how Internet addresses are used.

IPv6 Address Size

In IPv4, IP addresses are 32 bits long; these are usually grouped into four octets of eight bits each. The theoretical [IPv4 address space](#) is 2^{32} , or 4,294,967,296 addresses. To increase this address space we simply increase the size of addresses; each extra bit we give to the address size doubles the address space. Based on this, some folks expected the IPv6 address size to increase from 32 to 48 bits, or perhaps 64 bits. Either of these numbers would have given a rather large number of addresses.

However, IPv6 addressing doesn't use either of these figures; instead, the IP address size jumps all the way to 128 bits, or sixteen 8-bit octets/bytes. This represents a truly remarkable increase in the address size, which surprised a lot of people.

IPv6 Address Space

The 128 bits of IPv6 addresses mean the size of the IPv6 address space is, quite literally, astronomical; like the numbers that describe the number of stars in a galaxy or the distance to the furthest pulsars, the number of addresses that can be supported in IPv6 is mind-boggling. See [Figure 94](#) for an idea of what I mean by “astronomical”.

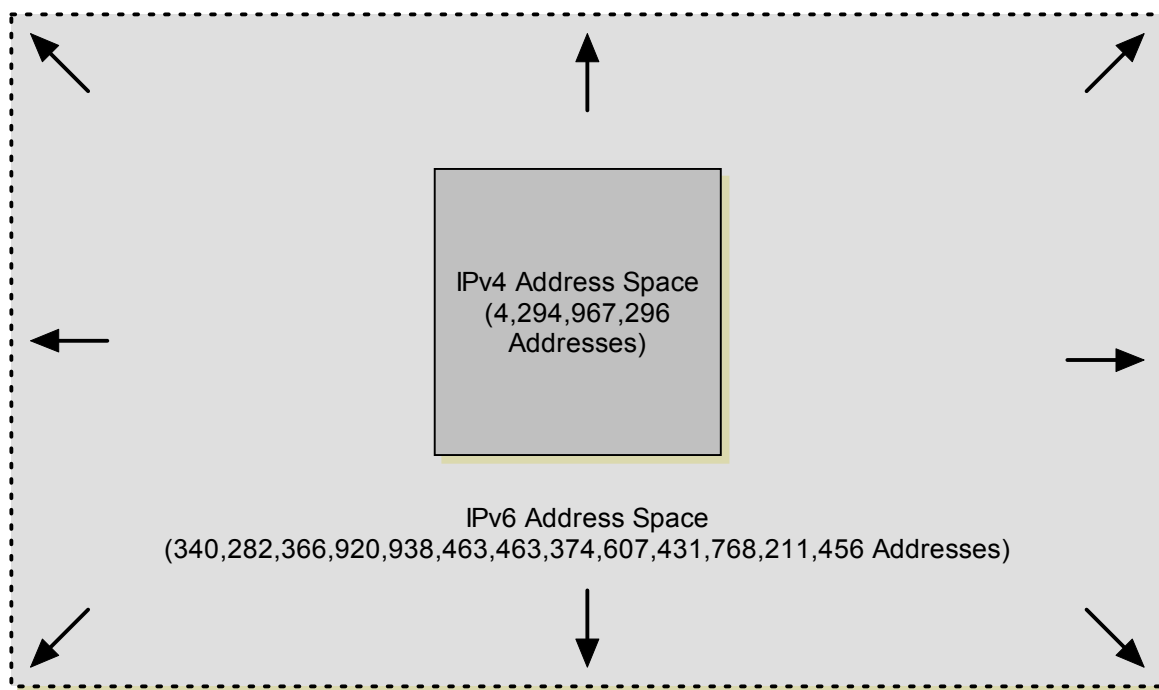

Figure 94: A (Poor) Representation of Relative IPv4 and IPv6 Address Space Sizes

I wanted to make a cool graphic to show the relative sizes of the IPv4 and IPv6 address spaces. You know, where I'd show the IPv6 address space as a big box and the IPv4 address space as a tiny one. The problem is that the IPv6 address space is **so** much larger than the IPv4 space that there is no way to show it to scale! To make this diagram to scale, imagine the IPv4 address space is the 1.6-inch square above. In that case, the IPv6 address space would be represented by a square **the size of the solar system**. ☺

Since IPv6 addresses are 128 bits long, the theoretical address space if all addresses were used is 2^{128} addresses. This number, when expanded out, is 340,282,366,920,938,463,374,607,431,768,211,456, which is normally expressed in scientific notation as about 3.4×10^{38} addresses. That's about 340 trillion, *trillion*, **trillion** addresses. As I said, it's pretty hard to grasp just how large this number is. Consider:

- ☉ It's enough addresses for many trillions of addresses to be assigned to every human being on the planet.
- ☉ The earth is about 4.5 billion years old. If we had been assigning IPv6 addresses at a rate of 1 billion per second since the earth was formed, we would have by now used up less than one **trillionth** of the address space.

-
- ☹ The earth's surface area is about 510 trillion square meters. If a typical computer has a footprint of about a tenth of a square meter, we would have to stack computers 10 billion high blanketing the entire surface of the earth to use up that same trillionth of the address space.

Okay, I think you get the idea. It's clear that one goal of the decision to go to 128-bit addresses is to make sure that we will never run out of address space again, and it seems quite likely that this will be the case.



Key Concept: The IPv6 address space is really, *really* big. 😊

Why Were IPv6 Addresses Made So Large?

However, there are drawbacks to having such a huge address space too. Consider that even with a 64-bit address, we'd have a very large address space: 2^{64} is 18,446,744,073,709,551,616 or about 18 million trillion, still probably more addresses than we will ever need. However, by going instead to 128 bits we have made dealing with IP addresses unruly (as we'll see in the next topic) and we have also increased overhead, since every datagram header or other place where IP addresses are referenced must use 16 bytes for each address instead of the 4 that were needed in IPv4, or the 8 that might have been required with a 64-bit address.

So why the “overkill” of going to 128 bits? The main reason is **flexibility**. Even though we can have a couple zillion addresses if we allocate them one at a time, that makes assignment difficult. We got rid of class-oriented addressing in IPv4 due to the fact that it wasted address space, which is true. The reality, though, is that being able to “waste” address space is a useful luxury.

Having 128 bits allows us to divide the address space and assign various purposes to different bit ranges while still not having to worry about running out of space. [In the topic describing the IPv6 global unicast address format](#) we'll see one way that those 128 bits are put to good use; it allows us to create a hierarchy of networks while still saving 64 bits for host IDs, which has its own advantages.

IPv6 Address and Address Notation and Prefix Representation

Increasing the size of IP addresses from 32 bits to 128 bits expands the address space to a gargantuan size, ensuring that we will never again run out of IP addresses, and allowing us flexibility in how they are assigned and used. Unfortunately, there are some drawbacks to this method, and one of them is that 128-bit numbers are very large, which makes them awkward and difficult to use.

The disadvantage is that many people, even computer people, find hexadecimal difficult to comprehend and work with, especially because the notion of 16 values in each digit is a bit strange. (I'm not one of them, but then I'm a geek.)

The hexadecimal notation used for IPv6 addresses is similar to the same method used for IEEE 802 MAC addresses, for technologies like Ethernet. There, 48 bits are represented by six octets, each octet being a hexadecimal number from 0 to FF, separated by a dash or colon, like this:

0A-A7-94-07-CB-D0

Since IPv6 addresses are larger, they are instead grouped into eight 16-bit *words*, separated by colons, to create what is sometimes called *colon hexadecimal notation*, again shown in [Figure 95](#). So, the IPv6 address given in the example above would be expressed as:

805B:2D9D:DC28:0000:0000:FC57:D4C8:1FFF

To keep size down, leading zeroes can be suppressed in the notation, so we can immediately reduce this to:

805B:2D9D:DC28:0:0:FC57:D4C8:1FFF

Hmm. Well, it's definitely shorter than dotted decimal, but still not much fun to look at. When you are dealing with numbers this big, there's only so much you can do. This is part of why under IPv6, use of [DNS names for hosts](#) becomes much more important than it is in IPv4; who could remember a hex address that long?!

Zero Compression in IPv6 Addresses

Fortunately, there is a short-cut that can be applied to shorten some addresses even further. This technique is sometimes called *zero compression*. The method allows a single string of contiguous zeroes in an IPv6 address to be replaced by a double-colon. So, for example, the address above could be expressed as:

805B:2D9D:DC28::FC57:D4C8:1FFF

We know how many zeroes are replaced by the “::” because we can see how many fully-expressed (“uncompressed”) hex words are in the address. In this case there are six, so the “::” represents two zero words. To prevent ambiguity, the double-colon can appear only once in any IP address, because if it appeared more than once we could not tell how many zeroes were replaced in each instance. So, if our example address were 805B:2D9D:DC28:0:0:FC57:0:0, we could replace either the first pair of zeroes or the second, but not both.

Zero compression doesn't make our example much shorter, but due to how IPv6 addresses are structured, long strings of zeroes are common. For example, consider this address:

FF00:4501:0:0:0:0:0:32

With compression, this could be expressed as just:

FF00:4501::32

It works even better on special addresses. The full IPv6 loopback address is:

0:0:0:0:0:0:0:1

With compression, this is simply:

::1

For even more fun, consider the Even more odd, the IPv6 “unspecified” address:

0:0:0:0:0:0:0:0

Apply zero compression to an address that is all zeroes, and what do you get? That’s right:

::

No numbers at all! Of course thinking of “::” as an address **does** take some getting used to.



Key Concept: For brevity, IPv6 addresses are represented using eight sets of four hexadecimal digits, a form called *colon hexadecimal notation*. Additional techniques, called *zero suppression* and *zero compression*, are used to reduce the size of displayed addresses further by removing unnecessary zeroes from the presentation of the address.

IPv6 Mixed Notation

There is also an alternative notation used in some cases, especially for expressing IPv6 addresses that embed IPv4 addresses. For these, it is useful to show the IPv4 portion of the address in the older dotted decimal notation, since that’s what we use for IPv4. Since embedding uses the last 32 bits for the IPv4 address, the notation has the first 96 bits in colon hexadecimal notation, and the last 32 bits in dotted decimal. So to take our same example again from above, in *mixed notation* it would be shown as:

805B:2D9D:DC28::FC57:212.200.31.255

This isn’t really a great example of mixed notation, because embedding usually involves long strings of zeroes followed by the IPv4 address. Thus, zero compression comes in very handy here. Instead of seeing something like this:

0:0:0:0:0:0:212.200.31.255

You will typically see just:

::212.200.31.255

At first glance this appears to be an IPv4 address; you have to keep a close eye on those colons in IPv6!



Key Concept: A special mixed notation is defined for IPv6 addresses whose last 32 bits contain an embedded IPv4 address. In this notation, the first 96 bits are displayed in regular colon hexadecimal notation, and the last 32 bits in IPv4-style dotted decimal.

IPv6 Address Prefix Length Representation

Like IPv4 classless addresses, IPv6 addresses are fundamentally divided into a number of network ID bits followed by a number of host ID bits. The network identifier is called the *prefix*, and the number of bits used is the *prefix length*. This prefix is represented by following the address by a slash and then putting the prefix length after the slash. This is [the same method used for classless IPv4 addressing with CIDR](#). For example, if the first 48 bits of our example address were the network ID (prefix), then we would express this as 805B:2D9D:DC28::FC57:D4C8:1FFF/48.



Key Concept: In IPv6 the size of an address's prefix is indicating by the prefix length that follows the address, separated with a slash, just as this is done in IPv4 classless addressing.

As in IPv4, specifiers for whole networks will typically end in long strings of zeroes. These can be replaced by "::" using zero compression. For example, the 48 bit network ID for the example above is 805B:2D9D:DC28:0:0:0:0:0/48, or 805B:2D9D:DC28::/48. You *must* include the "::" if replacing the trailing zeroes.

IPv6 Address Space Allocation

After dealing for so many years with the very small IPv4 address space, the enormous number of addresses in IPv6 must have made the IETF engineers feel like kids in a candy shop. They were good kids, however, and didn't run wild grabbing all the candy they could find and gobbling it up. They very carefully considered how to divide the address space for various uses. Of course, when you have this much candy, sharing becomes pretty easy.

The Initial IPv6 Address Space Allocation Plan and the Format Prefix (FP)

As was the case with IPv4, the two primary concerns in deciding how to divide the IPv6 address space were address assignment and routing. The designers of IPv6 wanted to structure the address space to make allocation of addresses to ISPs, organizations and individuals as easy as possible.

At first, this perhaps ironically, this led the creators of IPv6 back full circle to the use of specific bit sequences to identify different types of addresses, just like the old “classful” addressing scheme. The address type was indicated by a set of bits at the start of the address, called the *format prefix (FP)*. The format prefix was conceptually identical to [the 1 to 4 bits used in IPv4 “classful” addressing to denote address classes](#), but was variable in length, ranging from three to ten bits. Format prefixes were described in RFC 2373.

In the years following the publication of RFC 2373, the gurus who run the Internet had a change of heart regarding how address blocks should be considered. They still wanted to divide up the IPv6 address space into variably-sized blocks for different purposes. However, they realize that many people (including myself) were starting to consider the use of format prefixes to be equivalent to the old class-oriented IPv4 system.

Their main concern was that implementors might program into IPv6 hardware logic to make routing decisions based only on the first few bits of the address. This was specifically *not* how IPv6 is supposed to work; for one thing, the allocations are subject to change. Thus, one of the modifications made in RFC 3513 was to change the language regarding IPv6 address allocations, and specifically, to remove the term “format prefix” from the standard.

Current IPv6 Address Space Allocation Plans

The allocation of different parts of the address space still is done based on particular patterns of the first three to ten bits of the address, to allow certain categories to have more addresses than others. The elimination of the specific term denoting this is intended to convey that these bits should not be given “special attention”.

[Table 61](#) shows the allocations of the IPv6 address space, and what fraction of the total address space each represents:

Table 61: IPv6 Address Space Allocations (Page 1 of 2)

Leading Bits	Fraction of Total IPv6 Address Space	Allocation
0000 0000	1/256	Unassigned (Includes special addresses such as the Unspecified and Loopback addresses)
0000 0001	1/256	Unassigned
0000 001	1/128	Reserved for NSAP Address Allocation
0000 01	1/64	Unassigned

Table 61: IPv6 Address Space Allocations (Page 2 of 2)

Leading Bits	Fraction of Total IPv6 Address Space	Allocation
0000 1	1/32	Unassigned
0001	1/16	Unassigned
001	1/8	Global Unicast Addresses
010	1/8	Unassigned
011	1/8	Unassigned
100	1/8	Unassigned
101	1/8	Unassigned
110	1/8	Unassigned
1110	1/16	Unassigned
1111 0	1/32	Unassigned
1111 10	1/64	Unassigned
1111 110	1/128	Unassigned
1111 1110 0	1/512	Unassigned
1111 1110 10	1/1024	Link-Local Unicast Addresses
1111 1110 11	1/1024	Site-Local Unicast Addresses
1111 1111	1/256	Multicast Addresses

This is more complicated than the IPv4 “classful” scheme because there are so many more categories and they range greatly in size, however, most of them are unassigned at the present time.

Looking at the IPv6 Address Space Plan As “Eight Eighths”

An easier way to make sense of this table is to consider the division of the IPv6 address space into ***eighths***. Of these eight groups, one (001) has been reserved for unicast addresses; a second (000) has been used to carve out smaller reserved blocks, and a third (111) has been used for sub-blocks for local and multicast addresses. Five are completely unassigned.

You can see that the IPv6 designers have taken great care to allocate only the portion of these “eighths” of the address space they felt was needed for each type of address. For example, only a small portion of the part of the address space beginning “111” was used, with most of it left aside. In total, only 71/512ths of the address space is assigned right now, or about 14%. The other 86% is unassigned and kept aside for future use. (Bear in mind that even 1/1024th of the IPv6 address space is gargantuan—it represents trillions of trillions of addresses.)

Subsequent topics in this section provide more information on several of these address blocks. Note that the “0000 0000” reserved block is used for several special address types, including [the loopback address](#), [the “unspecified” address](#) and [IPv4 address embedding](#). The “1111 1111” format prefix identifies [multicast addresses](#); this string is “FF” in hexadecimal, so any address beginning with “FF” is a multicast address in IPv6.

IPv6 Global Unicast Address Format

It is anticipated that unicast addressing will be used for the vast majority of Internet traffic under IPv6, just as is the case for older one, IPv4. It is for this reason that the largest of the [assigned blocks of the IPv6 address space](#) is dedicated to unicast addressing. A full 1/8th slice of the enormous IPv6 address “pie” is assigned to unicast addresses, which are indicated by a “001” in the first three bits of the address. The question then is: how do we use the remaining 125 bits in our spacious IP addresses?

Rationale for A Structured Unicast Address Block

When IPv4 was first created, the Internet was rather small, and the model for allocating address blocks was based on a [central coordinator: IANA](#). Everyone who wanted address blocks would go straight the central authority. As the Internet grew, this model became impractical. Today, IPv4's classless addressing scheme allows variable-length network IDs and hierarchical assignment of address blocks. Big ISPs get large blocks from the central authority and then subdivide them and allocate them to their customers, and so on. This is managed by today's Internet providers, but there is nothing in the address space that helps manage the allocation process. In turn, each organization has the ability to further subdivide their address allocation to suit their internal requirements.

The designers of IPv6 had the benefit of this experience and realized there would be tremendous advantages to designing the unicast address structure to reflect the overall topology of the Internet. These include:

- ☉ Easier allocation of address blocks at various levels of the Internet topological hierarchy.
- ☉ IP network addresses that automatically reflect the hierarchy by which routers move information across the Internet, allowing routes to be easily aggregated for more efficient routing.
- ☉ Flexibility for organizations like ISPs to subdivide their address blocks for customers.
- ☉ Flexibility for end-user organizations to subdivide their address blocks to match internal networks, much as subnetting did in IPv4.
- ☉ Greater “meaning” to IP addresses. Instead of just being a string of 128 bits with no structure, it would become possible to look at an address and know certain things about it.

Generic Division of the Unicast Address Space

The most generic way of dividing up the 128 bits of the unicast address space is into three sections, as shown in [Table 62](#).

Table 62: Generic IPv6 Global Unicast Address Format

Field Name	Size (bits)	Description
<i>Prefix</i>	"n"	Global Routing Prefix: The network ID or prefix of the address, used for routing.
<i>Subnet ID</i>	"m"	Subnet Identifier: A number that identifies a subnet within the site.
<i>Interface ID</i>	"128-n-m"	Interface ID: The unique identifier for a particular interface (host or other device). It is unique within the specific prefix and subnet.

The *global routing prefix* and *subnet identifier* represent the two basic levels at which addresses need to be hierarchically-constructed: global and site-specific. The routing prefix consists of a number of bits that can be further subdivided according to the needs of Internet Registries and Internet Service Providers, to reflect the topography of the Internet as a whole (we'll discuss this soon). The subnet ID gives a number of bits to site administrators for creating their own internal network structure.

IPv6 Implementation of the Unicast Address Space

In theory, any size for "n" and "m" could be used. The implementation chosen for IPv6, however, assigns 48 bits to the routing prefix and 16 bits to the subnet identifier. This means 64 bits are available for interface identifiers, which are constructed based on the IEEE "EUI-64" format, [as described in the next topic](#). Thus, the overall IPv6 unicast address format is constructed as shown in [Table 63](#) (illustrated in [Figure 96](#).)

Table 63: IPv6 Global Unicast Address Format

Field Name	Size (bits)	Description
<i>Prefix</i>	48	Global Routing Prefix: The network ID or prefix of the address, used for routing. The first three bits are "001" to indicate a unicast address.
<i>Subnet ID</i>	16	Subnet Identifier: A number that identifies a subnet within the site.
<i>Interface ID</i>	64	Interface ID: The unique identifier for a particular interface (host or other device). It is unique within the specific prefix and subnet.

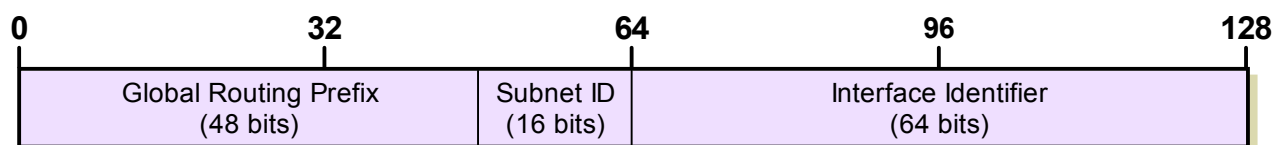

Figure 96: IPv6 Global Unicast Address Format



Key Concept: The part of the IPv6 address space set aside for unicast addresses is structured into an address format that uses the first 48 bits for the *routing prefix* (like a network ID), the next 16 bits for a *subnet ID*, and the final 64 bits for an *interface ID* (like a host ID).

Due to this structure, most end sites (regular companies and organizations, as opposed to Internet service providers) will be assigned IPv6 networks with a 48-bit prefix. In common parlance, these network identifiers have now come to be called *48s* or */48s*.

The 16 bits of subnet ID allow each site considerable flexibility in creating subnets that reflect the site's network structure. For example:

- ☉ A smaller organization can just set all the bits in the Subnet ID to zero and have a “flat” internal structure.
- ☉ A medium-sized organization could use all the bits in the Subnet ID to perform the equivalent of “straight” subnetting under IPv4, assigning a different Subnet ID to each subnet. There are 16 bits here, so this allows a whopping 65,536 subnets!
- ☉ A larger organization can use the bits to create a multiple-level hierarchy of subnets, exactly like IPv4's [Variable Length Subnet Masking \(VLSM\)](#). For example, the company could use two bits to create four subnets. It could then take the next three bits to create eight sub-subnets in some or all of the four subnets. There would still be 11 more bits to create sub-sub-subnets and so forth.

Original Division of the Global Routing Prefix: Aggregators

The global routing prefix is similarly divided into a hierarchy, but one that has been designed for the use of the entire Internet, a la [CIDR](#). There are 45 bits available here (48 bits less the first three that are fixed at “001”), which is a lot. When the unicast address structure was first detailed in RFC 2374, that document described a specific division of the 45 bits based on a two-level hierarchical topology of Internet registries and providers. These organizations were described as:

1. **Top-Level Aggregators (TLAs):** The largest Internet organizations, which were to be assigned large blocks of IPv6 addresses from registration authorities.
2. **Next-Level Aggregators (NLAs):** These organizations would get blocks of addresses from TLAs and divide them for end-user organizations (sites).

The 45 bits were split between these two uses, with a few bits reserved in the middle to allow expansion of either field if needed. Thus, the RFC 2374 structure for the 45 bits was as shown in [Table 64](#):

Table 64: Historical IPv6 Unicast Routing Prefix Structure

Field Name	Size (bits)	Description
<i>TLA ID</i>	13	Top-Level Aggregation Identifier: A globally-unique identifier for the Top-Level Aggregator. There are 13 bits so there were a maximum of 8,192 TLAs allowed.
<i>RES</i>	8	Reserved: These 8 bits were reserved for future use and set to zero. By leaving these 8 bits between the TLA ID and NLA ID unused, they could be later used to expand either the TLA ID or NLA ID fields as needed.
<i>NLA ID</i>	24	Next-Level Aggregation Identifier: Each TLA was given this 24-bit field to generate blocks of addresses for allocation to its customers. The NLA ID is unique for each TLA ID. The use of the 24 bits was left up to the TLA organization.

You'll notice my use of the past tense in the description of the TLA/NLA structure, and that table heading is a pretty big giveaway too. In August 2003, RFC 3587 was published, which in a nutshell says “uh, never mind about all that TLA/NLA stuff”. ☺ The decision was made that having this structure “hard-coded” into an Internet standard was inflexible, and it made more sense to allow the [regional Internet registries \(APNIC, ARIN, LACNIC and RIPE\)](#) decide for themselves how to use the 45 bits.



Note: The obsoleting of the “TLA/NLA” structure occurred after many years of people getting used to it, so for some time to come you will still routinely see mention of those terms in IPv6 descriptions. (This is why I included discussion of them here.)

An Example Division of the Global Routing Prefix Into Levels

So, there is no longer any single structure for determining how the 48-bit routing prefix is divided in the global unicast hierarchy. As one example, it might be possible to divide it into three levels, as shown in [Table 65](#), and diagrammed in [Figure 97](#).

Table 65: Example IPv6 Unicast Routing Prefix Structure

Field Name	Size (bits)	Description
<i>(Unicast Indicator)</i>	3	Each unicast address starts with “001”; there is no official name for this (it used to be called the <i>Format Prefix</i>).
<i>Level1 ID</i>	10	Level 1 Identifier: The identifier of the highest level in the hierarchy. This would be used for assigning to the biggest Internet organizations the largest blocks of addresses in the global hierarchy. The number of Level 1 organizations would be 2^{10} or 1,024.
<i>Level2 ID</i>	12	Level 2 Identifier: Each block assigned to a Level 1 organization would use 12 bits to create 4,096 address blocks to divide amongst the lower-level organizations it serves.
<i>Level3 ID</i>	23	Level 3 Identifier: Each Level 2 organization has 23 bits to use to divide its Level 2 address block. Thus, it could create over 8 million individual “/48” address blocks to assign to end user sites. Alternately, the 23 bits could be divided further into still lower levels to reflect the structure of the Level 2 organization's customers.

This is just one possible, theoretical way that the bits in a “/48” network address could be assigned. As you can see, with so many bits there is a lot of flexibility. In the scheme above we can have over 4 million level 2 organizations, **each of which** can assign 8 million /48 addresses. And each of those is equivalent in size to an IPv4 Class B address (over 65,000 hosts)!

Additional Notes on the Global Unicast Format

The removal of RFC 2374's “fixed structure” for the global routing prefix is consistent with the IPv6 development team's efforts to emphasize that bit fields and structures are used **only** for allocating addresses, not for routing purposes. The addresses themselves, once created, are not interpreted by hardware on an internet based on this format. To routers, the only structure is the division between the network ID and host ID is given by the prefix length that trails the IP address, and this division can occur at any bit boundary. These hardware devices just see 128 bits of an IP address and use it without any knowledge of hierarchical address divisions or “levels”.

It's also worth noting that the key to obtaining the allocation benefits of the aggregatable unicast address format is the abundance of bits available to us under IPv6. The ability to have these hierarchical levels while still allowing 64 bits for the interface ID is **one of the main reasons why IPv6 designers went all the way from 32 bits to 128 bits for address size**. By creating this structure, we maintain flexibility while avoiding the potential chaos of trying to allocate many different network sizes within our 128 bits.

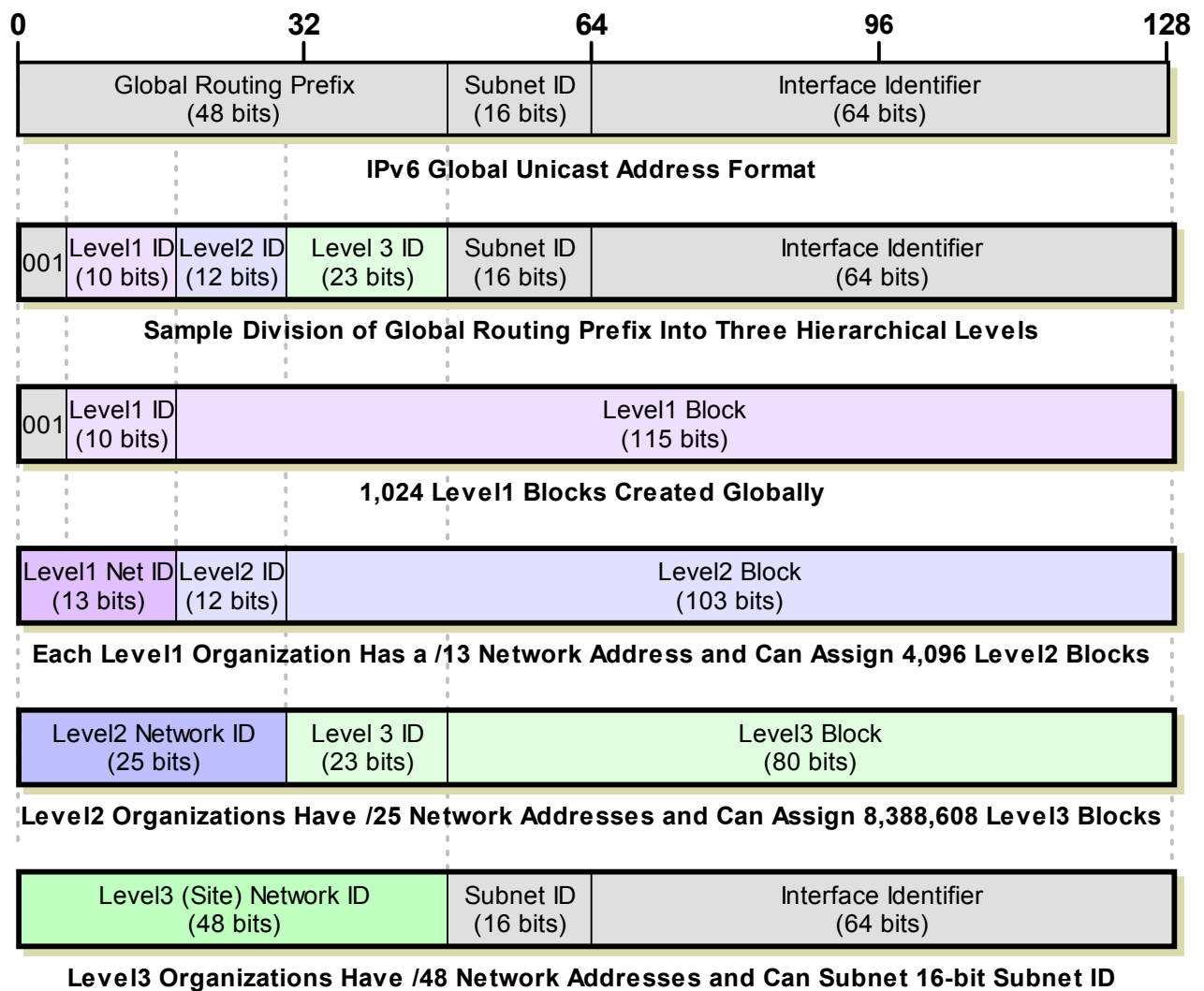

Figure 97: Example IPv6 Unicast Routing Prefix Structure

The top row shows the global IPv6 unicast address format. The second shows one example way to divide the Global Routing Prefix, into three levels using 10, 12 and 23 bits respectively. The third row shows how the first 10 bits are used to create 2^{10} or 1,024 different Level1 blocks. The next row illustrates that for each of these 13-bit prefixes, we could have 2^{12} or 4,096 Level2 blocks. Then, within each 25-bit Level2 ID, we have 23 bits or 8,388,608 Level3 blocks. At the bottom, a Level3 or "/48" would be assigned to an individual organization.

Finally, note that [anycast addresses](#) are structured in the same way as unicast addresses, so they are allocated according to this same model. In contrast, multicast addresses are not; they are allocated from their own portion of the IPv6 address space.

IPv6 Interface Identifiers and Physical Address Mapping

In IPv4, IP addresses have no relationship to the addresses used for underlying data link layer network technologies. A host that connects to a TCP/IP network using an Ethernet network interface card (NIC) has an Ethernet MAC address and an IP address, but the two numbers are distinct and unrelated in any way. IP addresses are assigned manually by administrators without any regard for the underlying physical address.

The Payoff of IPv6's Very Large Address Size

With the overhaul of addressing in IPv6, an opportunity presented itself to create a better way of mapping IP unicast addresses and physical network addresses. Implementing this superior mapping technique was one of the reasons why IPv6 addresses were made so large. With 128 total bits, as we saw in [the previous topic](#), even with a full 45 bits reserved for network prefix and 16 bits for site subnet, we are still left with 64 bits to use for the *interface identifier*, which is analogous to the host ID under IPv4.

Having so many bits at our disposal gives us great flexibility. Instead of using arbitrary “made-up” identifiers for hosts, we can base the interface ID on the underlying data link layer hardware address, as long as that address is no greater than 64 bits in length. Since virtually all devices use layer two addresses of 64 bits or fewer, there is no problem in using those addresses for the interface identifier in IP addresses. This provides an immediate benefit: it makes networks easier to administer, since we don't have to record two arbitrary numbers for each host. The IP address can be derived from the MAC address and the network identifier. It also means we can in the future tell the IP address from the MAC address and vice-versa.

The IPv6 Modified EUI-64 Format

The actual mapping from data link layer addresses to IP interface identifiers depends on the particular technology. It is essential that all devices on the same network use the same mapping technique, of course. By far the most common type of layer 2 addresses in networking are IEEE 802 MAC addresses, used by Ethernet and other IEEE 802 Project networking technologies. As you may already know, these addresses have 48 bits, arranged into two blocks of 24. The upper 24 bits are arranged into a block called the *organizationally unique identifier (OUI)*, with different values assigned to individual organizations; the lower 24 bits are then used for an identifier for each specific device.

The IEEE has also defined a format called the *64-bit extended unique identifier*, abbreviated *EUI-64*. It is similar to the 48-bit MAC format, except that while the OUI remains at 24 bits, the device identifier becomes 40 bits instead of 24. This provides gives each manufacturer 65,536 times as many device addresses within its OUI.

A form of this format, called *modified EUI-64*, has been adopted for IPv6 interface identifiers. To get the modified EUI-64 interface ID for a device, you simply take the EUI-64 address and change the 7th bit from the left (the “universal/local” or “U/L” bit) from a zero to a one.

Converting 48-Bit MAC Addresses to IPv6 Modified EUI-64 Identifiers

Of course, most devices still use the older 48-bit MAC address format. These can be converted to EUI-64 and then to modified EUI-64 form for creating an IPv6 interface ID. The process is as follows:

1. We take the 24-bit OUI portion, the left-most 24 bits of the Ethernet address, and put them into the left-most 24 bits of the interface ID. We take the 24-bit local portion (the right-most 24 bits of the Ethernet address) and put it into the right-most 24 bits of the interface ID.
2. In the remaining 16 bits in the middle of the interface ID we put the value “11111111 11111110” (“FFFE” in hexadecimal).
3. The address is now in EUI-64 form. We change the “universal/local” bit (bit 7 from the left) from a zero to a one. This gives us the modified EUI-64 interface ID.



Key Concept: The last 64 bits of IPv6 unicast addresses are used for interface identifiers, which are created in a special format called *modified EUI-64*. A simple process can be used to determine the interface identifier from the 48-bit MAC address of a device like an Ethernet network interface card. This can then be combined with a network prefix (routing prefix and subnet ID) to determine a corresponding IPv6 address for the device.

Let's take as an example the Ethernet address of 39-A7-94-07-CB-D0 (illustrated in [Figure 98](#)):

1. We take “39-A7-94”, the first 24 bits of the identifier, and put it into the first (leftmost) 24 bits of the address. The local portion of “07-CB-D0” becomes the last 24 bits of the identifier.
2. The middle 16 bits are given the value “FF-FE”.
3. We change the seventh bit from zero to one, which changes the first octet from “39” to “3B”.

The identifier thus becomes “3B-A7-94-FF-FE-07-CB-D0”, or in IPv6 colon hexadecimal notation, 3BA7:94FF:FE07:CBD0. The first 64 bits of the device's address are supplied using [the global unicast address format](#).

The only drawback of this technique is that if the physical hardware changes, so does the IPv6 address.

IPv6 Special Addresses: Reserved, Private (Link-Local / Site-Local), Unspecified and Loopback

Just as [certain IPv4 address ranges are designated for reserved, private and other “unusual” addresses](#), a small part of the monstrous IPv6 address space has been set aside for special addresses. The purpose of these addresses and address blocks is to provide addresses for special requirements and private use in IPv6 networks. The nice thing about

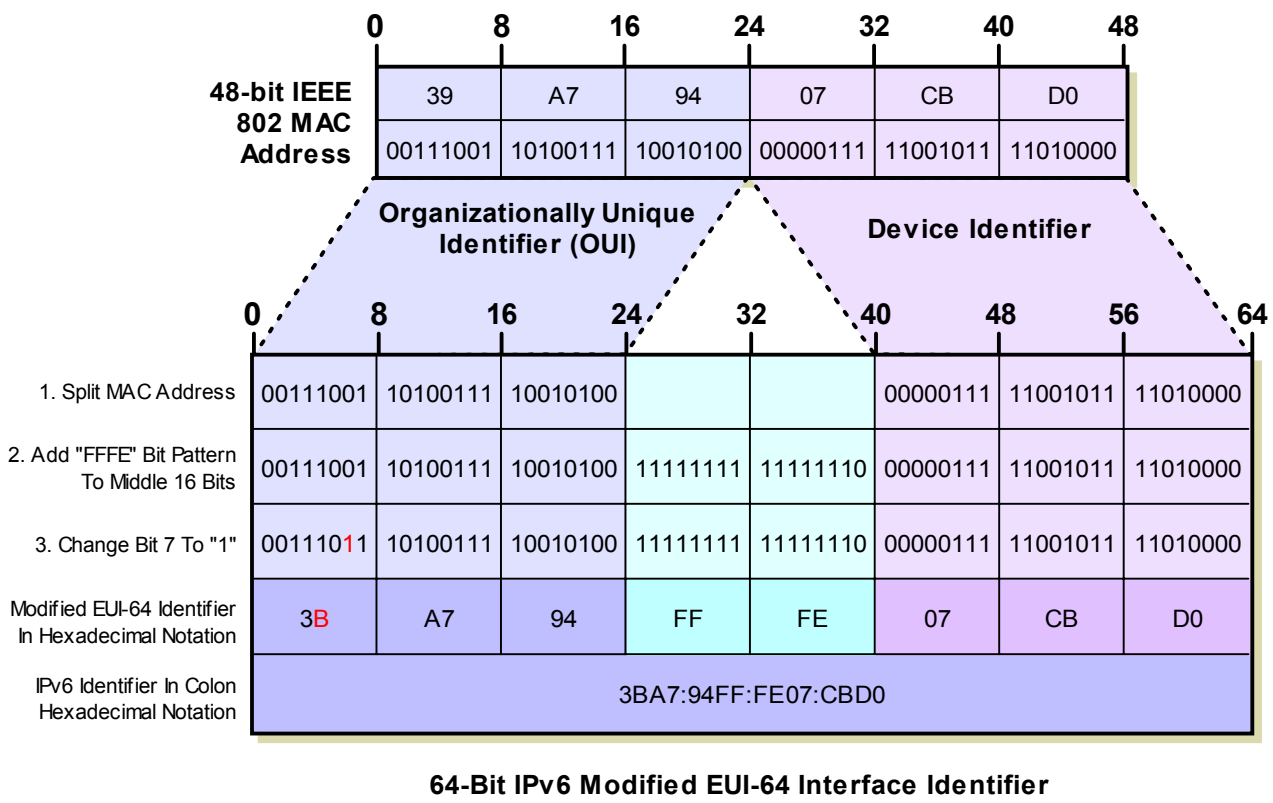

Figure 98: Converting IEEE 802 MAC Addresses To IPv6 Modified EUI-64 Identifiers

IPv6, of course, is that even relatively small pieces of it are still enormous, so setting aside 0.1% of the address space for a particular use still generally yields more addresses than anyone will ever need.

Special IPv6 Address Types

There are four basic types of "special" IPv6 addresses: reserved, private, loopback and unspecified.

Reserved Addresses

A portion of the address space is set aside as reserved for various uses by the IETF, both present and future. Unlike IPv4, which has many small reserved blocks in various locations in the address space, in IPv6 the reserved block is at the "top" of the address space: the ones starting with "0000 0000" (or 00 for the first hexadecimal octet). This represents 1/256th of the total address space. Some of the special addresses below come from this block. [IPv4 address embedding](#) is also done within this reserved address area.



Note: Note that reserved addresses are not the same as *unassigned* addresses. The latter term just refers to blocks whose use has not yet been determined.

Private/Unregistered/Nonrouteable Addresses

A block of addresses is set aside for private addresses, just as in IPv4, except that like everything in IPv6 the private address block in IPv6 is much larger. These private addresses are local only to a particular link or site and are therefore never routed outside a particular company's network.

Private addresses are indicated by the address having "1111 1110 1" for the first nine bits. Thus, private addresses have a first octet value of "FE" in hexadecimal, with the next hex digit being from "8" to "F". These addresses are further divided into two types based on their scope, described below.

Loopback Address

Like IPv4, provision has been made for a special [loopback address for testing](#); datagrams sent to this address "loop back" to the sending device. However, in IPv6 there is just one address for this function, not a whole block (which was never needed in the first place, really!) The loopback address is 0:0:0:0:0:0:0:1, which is normally expressed using zero compression as "::1".

Unspecified Address

In IPv4, an IP address of all zeroes has a [special meaning](#); it refers to the host itself, and is used when a device doesn't know its own address. In IPv6 this concept has been formalized, and the all-zeroes address (0:0:0:0:0:0:0:0) is named the *unspecified address*. It is typically used in the source field of a datagram sent by a device seeking to have its IP address configured. Zero compression can be applied to this address; since it is all zeroes, the address becomes just "::". (I consider this confusing, myself. I think something like "0::0" is a lot more clear, and short enough.)



Key Concept: In IPv6, a special *loopback address*, 0:0:0:0:0:0:0:1 ("::1" in compressed form) is set aside for testing purposes. The *unspecified address*, 0:0:0:0:0:0:0:0 ("::" in compressed form) is used to indicate an unknown address. A block of *private* or *local* addresses is defined, which is the set of all addresses beginning with "1111 1110 1" as the first nine bits.

IPv6 Private Addresses Types/Scopes

Now, let's take a bit more of a look at private addresses. In IPv6, these are called *local-use* addresses, the name conveying clearly what they are for. They are also sometimes called *link-layer* addresses. Recall that IPv4 private addresses were commonly used when public addresses could not be obtained for all devices, sometimes in combination with technologies like [Network Address Translation \(NAT\)](#). In IPv6, trickery like NAT isn't required. Instead, local-use addresses are intended for communication that is inherently designed only to be sent to local devices. For example, neighbor discovery functions using the [IPv6 Neighbor Discovery \(ND\)](#) protocol employ local-use addresses.

The *scope* of local addresses is obviously a local network, and not the global scope of public Internet addresses. Local addresses in IPv6 are divided further into two types, reflecting a further division of local scope.

Site-Local Addresses

These addresses have the scope of an entire site, or organization. They allow addressing within an organization without need for using a public prefix. Routers will forward datagrams using site-local addresses within the site, but not outside it to the public Internet.

Site-local addresses are differentiated from link-local addresses by having a tenth bit of “1” following the nine starting address bits common to all private IPv6 addresses. Thus, they begin with “1111 1110 1”. In hexadecimal, site-local addresses begin with “FE” and then “C” to “F” for the third hex digit. So, these addresses start with “FEC”, “FED”, “FEE” or “FEF”.

Link-Local Addresses

These addresses have a smaller scope than site-local addresses; they refer only to a particular physical link (physical network). Routers will not forward datagrams using link-local addresses at all, not even within the organization; they are only for local communication on a particular physical network segment. They can be used for [address configuration](#) or for the ND functions such as [address resolution](#) and [neighbor discovery](#).

Link-local addresses are differentiated from site-local addresses by having a tenth bit of “0” following the nine initial address bits common to all private IPv6 addresses: “1111 1110 1”. Thus, site-local addresses begin with “FE” and then “8” to “B” for the third hex digit. So, these addresses start with “FE8”, “FE9”, “FEA” or “FEB”.



Key Concept: IPv6 site-local addresses allow data to be sent only to the devices within a site or organization. They begin with “FEC”, “FED”, “FEE” or “FEF” in hexadecimal. IPv6 link-local addresses are used only on a particular local link (physical network), typically for special purposes such as address resolution or neighbor discover. They start with “FE8”, “FE9”, “FEA” or “FEB”.

Note that site-local IPv6 addresses are the equivalent of IPv4 private addresses, since they are routed throughout the organization. The concept of link-local scope is new to IPv6.

IPv6/IPv4 Address Embedding

Due to the importance of the Internet Protocol and the significance of the changes made in IPv6, deployment of the newer version of the protocol will not occur all at once. A *transition* from IPv4 to IPv6 will be required, which requires careful planning. It is anticipated that the migration from IPv4 to IPv6 will take many years. [I discuss this in a special topic dedicated to IPv4/IPv6 transition issues.](#)

IPv6 is backward compatible with IPv4, provided that special techniques are used. For example, to enable communication between "islands" of IPv6 devices connected by IPv4 networks, tunneling may be employed. To support IPv4/IPv6 compatibility, a scheme was developed to allow IPv4 addresses to be *embedded* within the IPv6 address structure. This method takes regular IPv4 addresses and puts them in a special IPv6 format so they are recognized as being IPv4 addresses by certain IPv6 devices.

Since the IPv6 address space is so much bigger than that of IPv4, embedding the latter within the former is easy; it's like tucking a compact sedan into the hold of a cargo ship. The embedding address space is part of the [reserved address block](#) whose addresses begin with eight zero bits, but only a relatively small part of it. Two different embedding formats are used. Both have zeroes for the first 80 bits of the address, and put the embedded IPv4 address into the last 32 bits of the IPv6 address format. They differ on the value of the 16 remaining bits in between (bits 81 to 96, counting from the left):

The two embedding formats are used in order to indicate the capabilities of the device using the embedded address.

IPv4-Compatible IPv6 Addresses

These are special addresses assigned to IPv6-capable devices, such as so-called "dual stack" devices that speak both IPv4 and IPv6. They have all zeroes for the middle 16 bits; thus, they start off with a string of 96 zeroes, followed by the IPv4 address. An example of such an address, shown in [Figure 99](#), would be 0:0:0:0:0:0:101.45.75.219 in mixed notation, or more succinctly, ::101.45.75.219.

IPv4-Mapped IPv6 Addresses

These are regular IPv4 addresses that have been mapped into the IPv6 address space, and are used for devices that are only IPv4-capable. They have a set of 16 **ones** after the initial string of 80 zeroes, and then the IPv4 address. So, if an IPv4 device has the address 222.1.41.90, such as the one in [Figure 100](#), it would be represented as 0:0:0:0:0:FFFF:222.1.41.90, or ::FFFF:222.1.41.90.

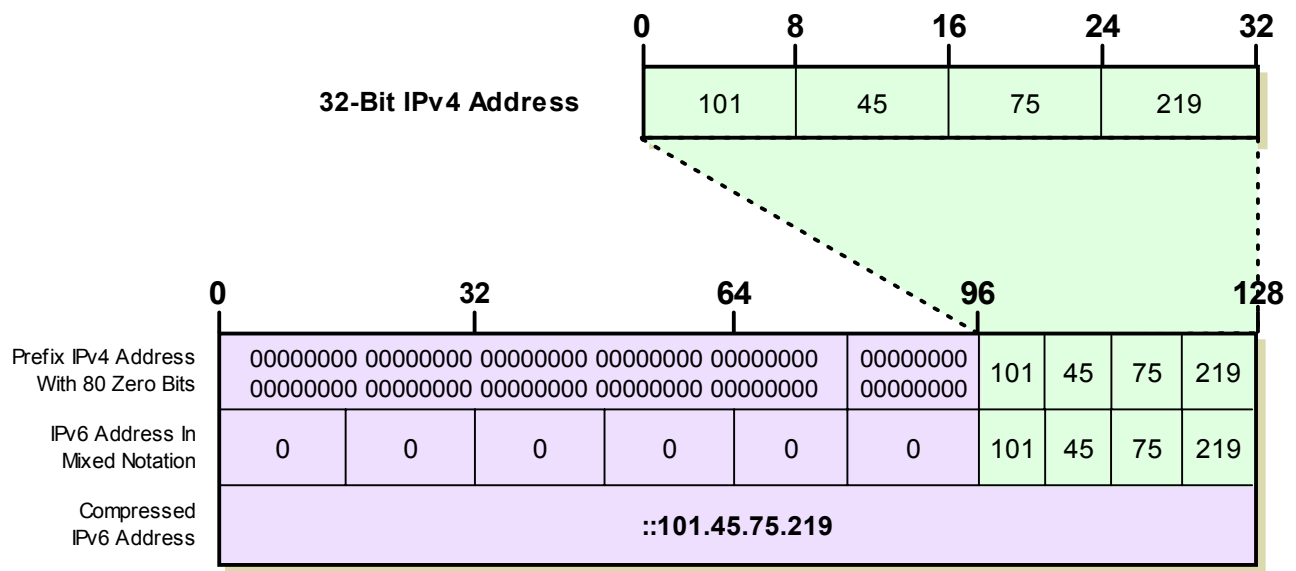

Figure 99: IPv4-Compatible Embedded IPv6 Address Representation

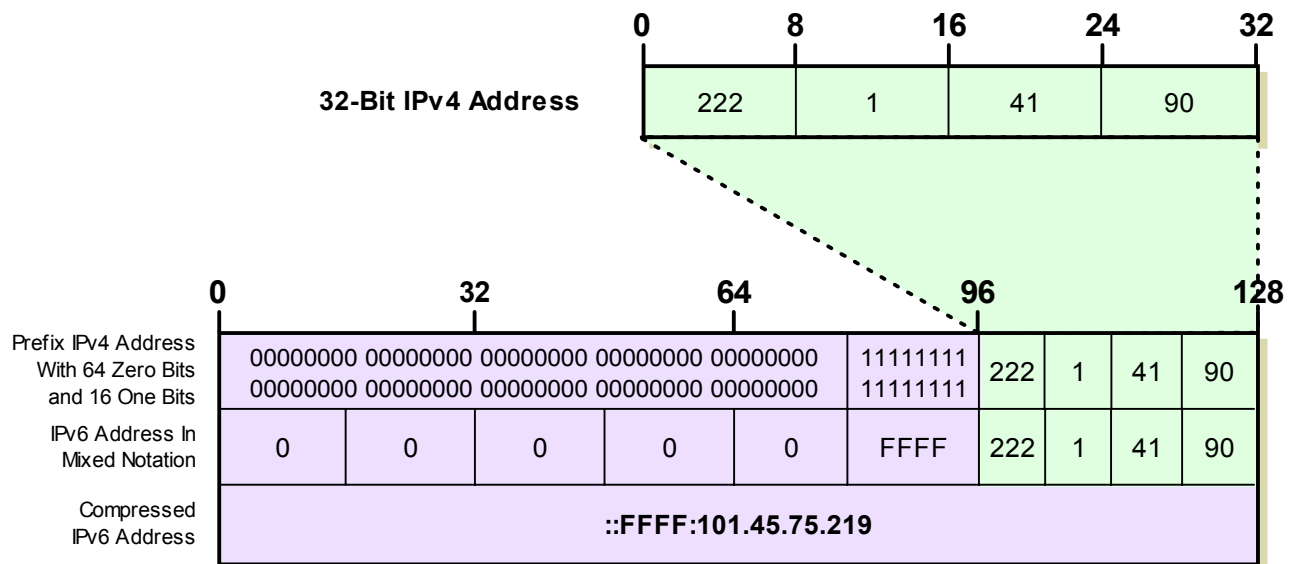

Figure 100: IPv4-Mapped Embedded IPv6 Address Representation



Key Concept: *IPv4 address embedding* is used to create a relationship between an IPv4 address and an IPv6 address to aid in the transition from IPv4 to IPv6. One type, the *IPv4-compatible IPv6 address*, is used for devices that are compatible with both IPv4 and IPv6; it begins with 96 zero bits. The other, the *IPv4-mapped address*, is used for mapping IPv4 devices that are not compatible with IPv6 into the IPv6 address space; it begins with 80 zeroes followed by 16 ones.

Comparing IPv4-Compatible and IPv4-Mapped Embedded IPv6 Addresses

The difference between these two kinds of addresses is subtle, but important. The first 80 bits are always zero, so when this is seen you know it is an embedded IPv4 address of some sort. IPv4-compatible IPv6 addresses are only used for devices that are actually IPv6-aware; the IPv4-compatible address is in addition to its conventional IPv6 address. In contrast, if the "FFFF" is seen for the 16 bits after the initial 80, this designates a conventional IPv4 device whose IPv4 address has been mapped into the IPv6 format. It is not an IPv6-capable device.

IPv6 Multicast and Anycast Addressing

One of the most significant modifications in the general addressing model in IPv6 was a change to the basic types of addresses and how they were used. Unicast addresses are still the choice for the vast majority of communications as in IPv4, but the "bulk" addressing methods are different in IPv6. Broadcast as a specific addressing type has been eliminated. Instead, support for multicast addressing has been expanded and made a required part of the protocol, and a new type of addressing called *anycast* has been implemented.

IPv6 Multicast Addresses

Let's start by looking at multicast under IPv6. Multicasting is used to allow a single device to send a datagram to a group of recipients. IPv4 supported [multicast addressing](#) using the Class D address block in the "classful" addressing scheme. Under IPv6, multicast addresses are allocated from the multicast block. This is 1/256th of the address space, consisting of all addresses that begin with "1111 1111". Thus, any address starting with "FF" in colon hexadecimal notation is an IPv6 multicast address.

The remaining 120 bits of address space are enough to allow the definition of, well, a gazillion or three multicast addresses. (Okay, it's officially about 1.3 trillion trillion trillion addresses.) Much the way the allocation of unicast addresses was organized by using a [special format](#) to divide up these many bits, the same thing was done for multicast addresses.

IPv6 Multicast Address Format

The format for multicast addresses is explained in [Table 66](#) and illustrated in [Figure 101](#).

Table 66: IPv6 Multicast Address Format

Field Name	Size (bits)	Description																
<i>(Indicator)</i>	8	The first eight bits are always “1111 1111” to indicate a multicast address. This used to be called the “Format Prefix” before the term was dropped as explained in the topic on IPv6 address space allocation ; the field now has no name.																
<i>Flags</i>	4	Flags: Four bits are reserved for flags that can be used to indicate the nature of certain multicast addresses. At the present time the first three of these are unused and set to zero. The fourth is the “ <i>T</i> ” (<i>Transient</i>) flag. If left as zero, this marks the multicast address as a permanently-assigned, “well-known” multicast address, as we will see below. If set to one, this means this is a <i>transient</i> multicast address, meaning that it is not permanently assigned.																
<i>Scope ID</i>	4	Scope ID: These four bits are used to define the scope of the multicast address; 16 different values from 0 to 15 are possible. This field allows multicast addresses to be created that are global to the entire Internet, or restricted to smaller spheres of influence such as a specific organization, site or link (see below). The currently defined values (in decimal) are: <table border="1" data-bbox="591 1003 1453 1381"><thead><tr><th>Scope ID Value</th><th>Multicast Address Scope</th></tr></thead><tbody><tr><td>0</td><td>Reserved</td></tr><tr><td>1</td><td>Node-Local Scope</td></tr><tr><td>2</td><td>Link-Local Scope</td></tr><tr><td>5</td><td>Site-Local Scope</td></tr><tr><td>8</td><td>Organization-Local Scope</td></tr><tr><td>14</td><td>Global Scope</td></tr><tr><td>15</td><td>Reserved</td></tr></tbody></table>	Scope ID Value	Multicast Address Scope	0	Reserved	1	Node-Local Scope	2	Link-Local Scope	5	Site-Local Scope	8	Organization-Local Scope	14	Global Scope	15	Reserved
Scope ID Value	Multicast Address Scope																	
0	Reserved																	
1	Node-Local Scope																	
2	Link-Local Scope																	
5	Site-Local Scope																	
8	Organization-Local Scope																	
14	Global Scope																	
15	Reserved																	
<i>Group ID</i>	112	Group ID: Defines a particular group within each scope level.																

Multicast Scopes

The notion of explicitly scoping multicast addresses is important. Globally-scoped multicast addresses must be unique across the entire Internet, but locally-scoped addresses are unique only within the organization. This provides tremendous flexibility, as every type of multicast address actually comes in several “versions”: one that multicasts only within a node, one on the local link (local network), one on the local site and so on. The scope also allows routers to immediately determine how broadly they should propagate multicast datagrams, to improve efficiency and eliminate problems with traffic being sent outside the area for which it is intended. [Figure 102](#) illustrates the notion of scope graphically (and it’s quite pretty, wouldn’t you say? ☺)

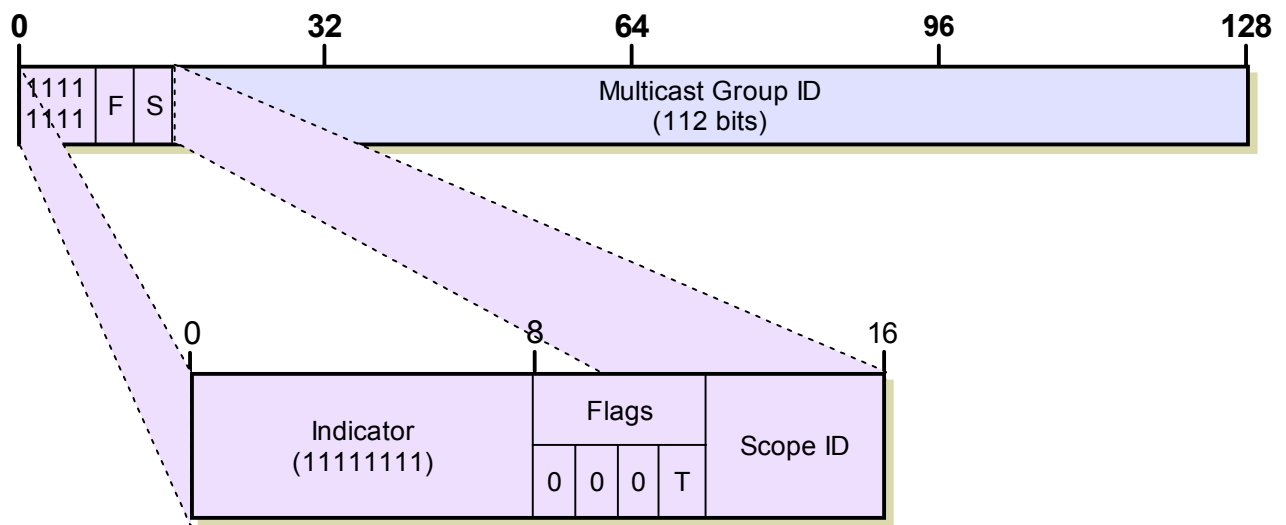

Figure 101: IPv6 Multicast Address Format



Key Concept: Multicast addresses are used to send data to a number of devices on an internetwork simultaneously. In IPv6 each multicast address can be specified for a variety of different *scopes*, allowing a transmission to be targeted to either a wide or narrow audience of recipient devices.

Well-Known Multicast Addresses

The *Transient* flag allows for explicit determination of which multicast addresses are available for normal use compared to which are set aside as “well-known”. Several predefined well-known multicast addresses are defined, by setting aside certain Group IDs that are used for a number of different scope ID values. [Table 67](#) shows these values; the “x” in the multicast address pattern is the hexadecimal digit corresponding to the 4-bit scope ID field.

The “All Nodes” and “All Routers” multicast addresses enable the equivalent function of what broadcast used to perform in IPv4. Again, the concept of scope is important in a multicast of this type because we don’t want to try to send a message to “all nodes” on the

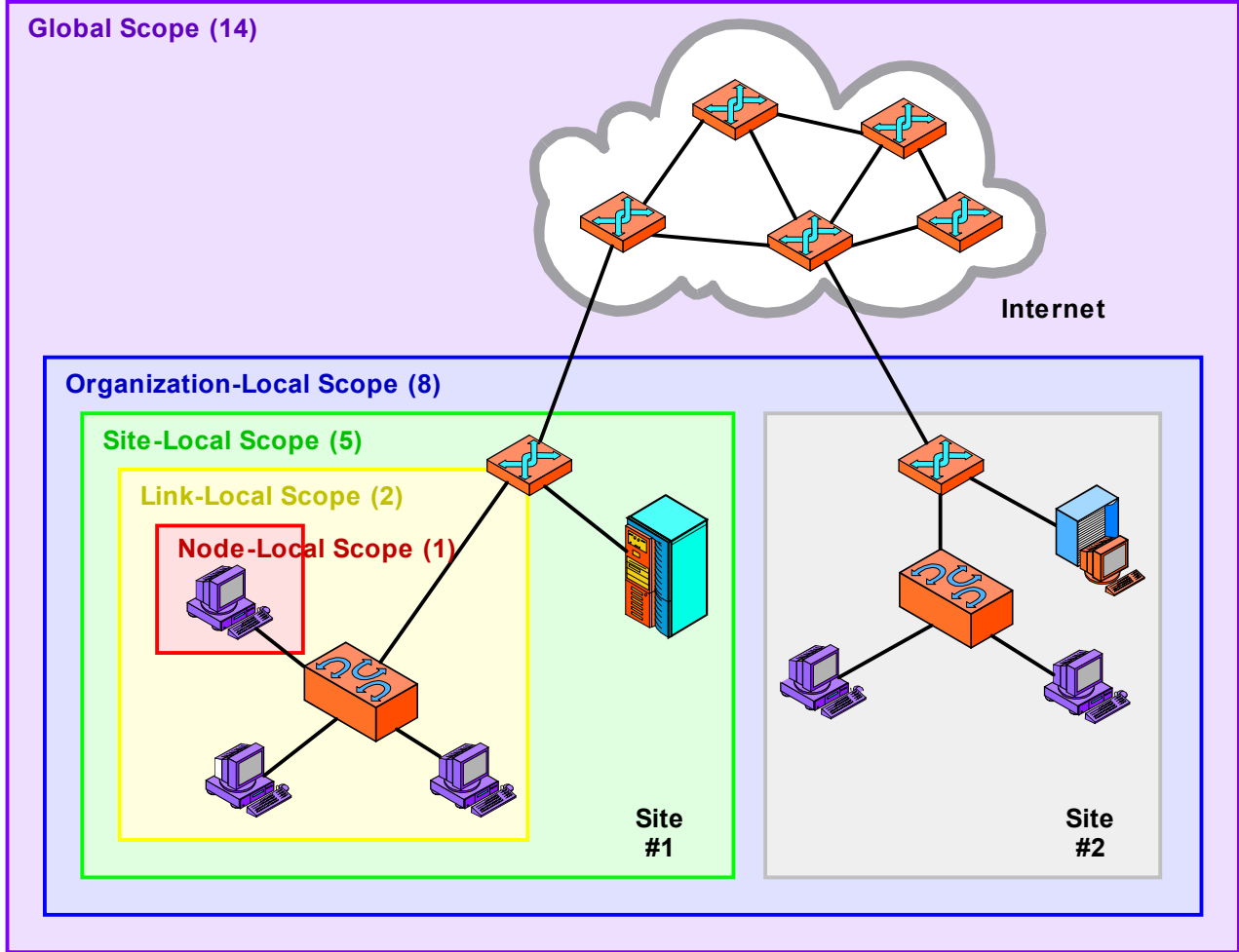

Figure 102: IPv6 Multicast Scope

This diagram shows how the notion of scope allows IPv6 multicasts to be limited to specific spheres of influence. The “tightest” scope is node-local scope, with a *Scope ID* value of 1. As the *Scope ID* value increases, the scope expands to cover the local network, site, organization, and finally, the entire Internet.

global Internet, for example. So, when the “all routers” address is used with a scope value of 2, it means “all routers on the local link”. If it is used with a value of 5, it means “all routers in this site”.

Table 67: Important IPv6 “Well-Known” Multicast Addresses (Page 1 of 2)

Multicast Address Pattern	Valid Scope Values (decimal)	Designation	Description
FF0x:0:0:0:0:0	0 to 15	Reserved	All multicast addresses where the 112-bit Group ID is zero are reserved.

Table 67: Important IPv6 “Well-Known” Multicast Addresses (Page 2 of 2)

Multicast Address Pattern	Valid Scope Values (decimal)	Designation	Description
FF0x:0:0:0:0:1	1, 2	All Nodes	When the Group ID is equal to exactly 1, this is a multicast to all nodes. Both node-local (FF01:0:0:0:0:1) and link-local (FF02:0:0:0:0:1) “all nodes” multicast addresses are possible.
FF0x:0:0:0:0:2	1, 2, 5	All Routers	When the group ID is equal to exactly 2, this designates all routers within a specific scope as the recipients. Valid scope values are node-local, link-local and site-local.

Solicited-Node Multicast Addresses

In addition to the regular multicast addresses, each unicast address has a special multicast address called its *solicited-node address*. This address is created through a special mapping from the device’s unicast address. Solicited-node addresses are used by the [IPv6 Neighbor Discovery \(ND\) protocol](#) to provide [more efficient address resolution](#) than the ARP technique used in IPv4.

All solicited-node addresses have their *T* flag set to zero and a scope ID of 2, so they start with “FF02”. The 112-bit group ID is broken down as follows (see [Figure 103](#)):

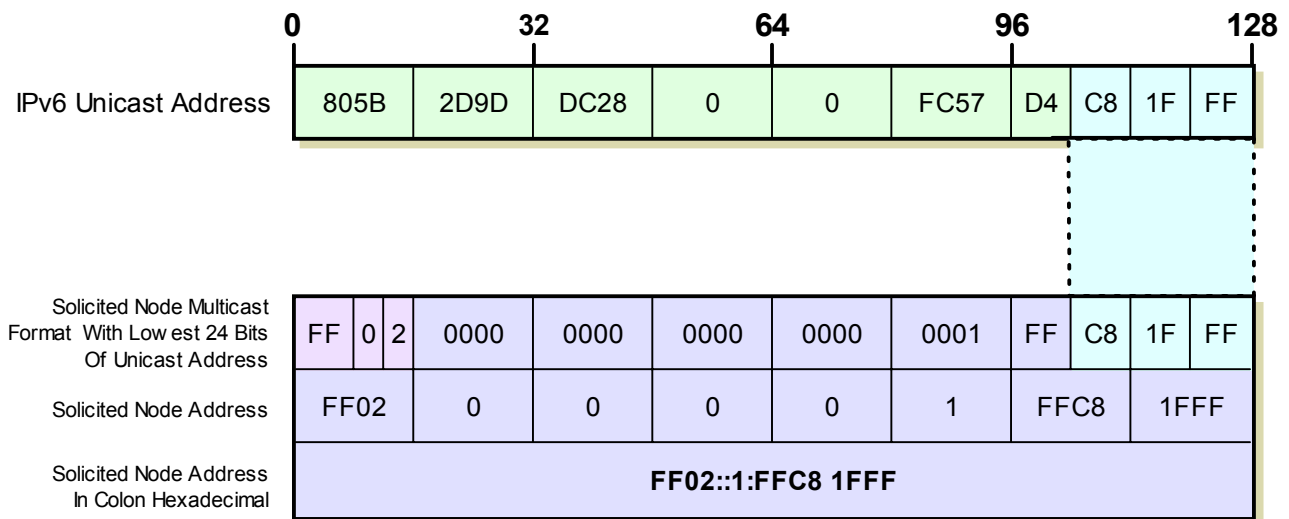

Figure 103: IPv6 Solicited Node Address Calculation

The solicited node multicast address is calculated from a unicast address by taking the last 24 bits of the address and prepending them with the IPv6 partial address “FF02:0:0:0:0:1:FF”. This shows the example address from [Figure 95](#) converted to its solicited node address, FF02::1:FFC8:1FFF.

-
- ☉ 80 bits consisting of 79 zeroes followed by a single one; this means that in colon hexadecimal notation, the next five hexadecimal values are “0000:0000:0000:0000:0001”, or more succinctly, “0:0:0:0:1”.
 - ☉ 8 ones: “FF”.
 - ☉ 24 bits taken from the bottom 24 bits of its unicast address.

So, these addresses start with “FF02:0:0:0:0:1:FF” followed by the bottom 24 bits of the unicast address. So, the node with IP address 805B:2D9D:DC28:0:0:FC57:D4C8:1FFF would have a solicited-node address of FF02:0:0:0:0:1:FFC8:1FFF (or FF02::1:FFC8:1FFF).



Key Concept: Each unicast address has an equivalent *solicited-node multicast address*, which is created from the unicast address and used when other devices need to reach it on the local network.

IPv6 Anycast Addresses

Anycast addresses are a new, unique type of address that is new to IP in IPv6; the IPv6 implementation is based on the material in RFC 1546, *Host Anycasting Service*. Anycast addresses can be considered a conceptual cross between unicast and multicast addressing. Where unicast says “send to this one address” and multicast says “send to every member of this group”, anycast says “send to any one member of this group”. Naturally, in choosing which member to send to, we would for efficiency reasons normally send to the closest one—closest in routing terms. So we can normally also consider anycast to mean “send to the closest member of this group”.

The idea behind anycast is to enable functionality that was previously difficult to implement in TCP/IP. Anycast was specifically intended to provide flexibility in situations where we need a service that is provided by a number of different servers or routers but don't really care which one provides it. In routing, anycast allows datagrams to be sent to whichever router in a group of equivalent routers is closest, to allow load sharing amongst routers and dynamic flexibility if certain routers go out of service. Datagrams sent to the anycast address will automatically be delivered to the device that is easiest to reach.

Perhaps surprisingly, there is no special anycast addressing scheme: anycast addresses are the same as unicast addresses. An anycast address is created “automatically” when a unicast address is assigned to more than one interface.

Like multicast, anycast creates more work for routers; it is more complicated than unicast addressing. In particular, the further apart the devices that share the anycast address are, the more complexity is created. Anycasting across the global Internet would be potentially difficult to implement, and IPv6 anycasting was designed for devices that are proximate to each other, generally in the same network. Also, due to the relative inexperience of the Internet community in using anycast, for the present time anycast addresses are used only by routers and not individual hosts.



Key Concept: Anycast addresses are new in IPv6 and can be used to set up a group of devices any one of which can respond to a request sent to a single IP address.

IPv6 Autoconfiguration and Renumbering

One of the most interesting and potentially valuable addressing features implemented in IPv6 is a facility to allow devices on an IPv6 to actually configure themselves independently. In IPv4 hosts were originally configured manually. Later, [host configuration protocols like DHCP](#) enabled servers to allocate IP addresses to hosts that joined the network. IPv6 takes this a step further, by defining a method for some devices to automatically configure their IP address and other parameters without the need for a server. It also defines a method whereby the IP addresses on a network can be renumbered (changed en masse). These are the sorts of features that make TCP/IP network administrators drool.

The IPv6 autoconfiguration and renumbering feature is defined in RFC 2462, *IPv6 Stateless Address Autoconfiguration*. The word “stateless” contrasts this method to the server-based method using something like [DHCPv6](#), which is called “stateful”. (Another word like “classful” that makes me cringe.) This method is called “stateless” because it begins from a “dead start” with no information (or “state”) at all for the host to work with, and has no need for a DHCP server.

IPv6 Stateless Autoconfiguration

Stateless autoconfiguration exploits several other new features in IPv6, including [link-local addresses](#), [multicasting](#), [the Neighbor Discovery \(ND\) protocol](#), and [the ability to generate the interface identifier of an address from the underlying data link layer address](#). The general idea is to have a device generate a temporary address until it can determine the characteristics of the network it is on, and then create a permanent address it can use based on that information. In the case of multi-homed devices, autoconfiguration is performed for each interface separately, as you would expect.

The following is a summary of the steps a device takes when using stateless autoconfiguration:

1. **Link-Local Address Generation:** The device generates a link-local address. Recall that this is one of the two types of [local-use IPv6 addresses](#). Link-local addresses have “1111 1110 10” for the first ten bits. The generated address uses those ten bits followed by 54 zeroes and then the 64 bit interface identifier. Typically this will be derived from the data link layer (MAC) address as explained in [the topic on interface identifiers](#), or it may be a “token” generated in some other manner.
2. **Link-Local Address Uniqueness Test:** The node tests to ensure that the address it generated isn't for some reason already in use on the local network. (This is very unlikely to be an issue if the link-local address came from a MAC address but more likely if it was based on a generated token.) It sends a *Neighbor Solicitation* message

using the [Neighbor Discovery \(ND\) protocol](#). It then listens for a *Neighbor Advertisement* in response that indicates that another device is already using its link-local address; if so, either a new address must be generated, or autoconfiguration fails and another method must be employed.

3. **Link-Local Address Assignment:** Assuming the uniqueness test passes, the device assigns the link-local address to its IP interface. This address can be used for communication on the local network, but not on the wider Internet (since link-local addresses are not routed).
4. **Router Contact:** The node next attempts to contact a local router for more information on continuing the configuration. This is done either by listening for *Router Advertisement* messages sent periodically by routers, or by sending a specific *Router Solicitation* to ask a router for information on what to do next. [This process is described in the section on the IPv6 Neighbor Discovery protocol](#).
5. **Router Direction:** The router provides direction to the node on how to proceed with the autoconfiguration. It may tell the node that on this network “stateful” autoconfiguration is in use, and tell it the address of a DHCP server to use. Alternately, it will tell the host how to determine its global Internet address.
6. **Global Address Configuration:** Assuming that stateless autoconfiguration is in use on the network, the host will configure itself with its globally-unique Internet address. This address is generally formed from a network prefix provided to the host by the router, combined with the device's identifier as generated in the first step.

Clearly, this method has numerous advantages over both manual and server-based configuration. It is particularly helpful in supporting mobility of IP devices, as they can move to new networks and get a valid address without any knowledge of local servers or network prefixes. At the same time, it still allows management of IP addresses using the (IPv6-compatible) version of DHCP if that is desired. Routers on the local network will typically tell hosts which type of autoconfiguration is supported using special flags in [ICMPv6 Router Advertisement messages](#).



Key Concept: IPv6 includes an interesting feature called stateless address autoconfiguration, which allows a host to actually determine its own IPv6 address from its layer two address by following a special procedure.

IPv6 Device Renumbering

Renumbering of devices is a method related to autoconfiguration. Like host configuration, it can be implemented using protocols like DHCP, through the use of IP address “leases” that expire after a period of time. Under IPv6, networks can be renumbered by having routers specify an expiration interval for network prefixes when autoconfiguration is done. Later, they can send a new prefix to tell devices to regenerate their IP addresses. Devices can actually maintain the old “deprecated” address for a while and then move over to the new address.

A similar technique was also defined for renumbering router addresses, in RFC 2894. It uses special ICMPv6 messages and is described in a topic in that section.



IPv6 Datagram Encapsulation and Formatting

Delivery of data over IPv6 internetworks is accomplished by encapsulating higher-layer data into *IPv6 datagrams*. These serve the same general purpose for IPv6 as [IPv4 datagrams](#) do in the older version of the protocol. However, they have been redesigned as part of the overall changes represented by IPv6. IPv6 datagrams have a flexible structure and their format better matches the needs of current IP networks.

In this section I take a look at the format used for IPv6 datagrams. I begin with an overview of the general structure of IPv6 datagrams, describing the major changes and showing how main and extension headers are arranged in the datagram. I then describe the format of the main header, and define and describe the various extension header types. I conclude with a brief explanation of IPv6 options and how they are implemented.



Background Information: This section assumes basic understanding of [IPv6 addressing concepts](#), and also general familiarity with [the IPv4 datagram format](#).

IPv6 Datagram Overview and General Structure

The method by which IPv6 encapsulates data received from higher-layer protocols for transmission across the internetwork is basically the same as [that used by IPv4](#). The data received from the transport or higher layers is made the payload of an IPv6 datagram, which has one or more headers that control the delivery of the message. These headers provide information to routers to enable them to move the datagram across the network, and also to hosts so they can tell which datagrams they are intended to receive.

Overview of Major Changes to Datagram Structure and Fields in IPv6

While the basic use of datagrams hasn't changed since IPv4, many modifications were made to their structure and format when IPv6 was created. This was done partly out of necessity: IPv6 addresses are different than IPv4 addresses and IP addresses go in the datagram header. The increase in the size of IP addresses from 32 bits to 128 bits adds a whopping extra 192 bits, or 24 bytes of information to the header. This in turn led to an effort to remove fields that weren't strictly necessary, to compensate for the necessary increase in size. However, changes were also made to IPv6 datagrams to add features to them and to make them better suit the needs of modern internetworking.

The following is a list of the most significant overall changes to datagrams in IPv6:

- ☉ **Multiple Header Structure:** Rather than a single header that contains all fields for the datagram (possibly including options), the IPv6 datagram supports a “main” header and then *extension headers* for additional information when needed.

- ☉ **Streamlined Header Format:** Several fields have been removed from the main header to reduce its size and increase efficiency. Only the fields that are truly required for pretty much *all* datagrams remain in the main header; others are put into extension headers and used as needed. Some were removed because they were no longer needed, such as the *Internet Header Length* field; the IPv6 header is of fixed length. This is discussed more thoroughly in [the topic on the main IPv6 header](#).
- ☉ **Renamed Fields:** Some fields have been renamed to better reflect their actual use in modern networks.
- ☉ **Greater Flexibility:** The [extension headers](#) allow a great deal of extra information to accompany datagrams when needed. [Options](#) are also supported in IPv6.
- ☉ **Elimination of Checksum Calculation:** In IPv6, a checksum is no longer computed on the header. This saves both the calculation time spent by every device that packages IP datagrams (hosts and routers) and the space the checksum field took up in the IPv4 header.
- ☉ **Improved Quality of Service Support:** A new field, the *Flow Label*, is defined to help support the prioritization of traffic.



Key Concept: IPv6 datagrams use a general structure that begins with a mandatory main header 40 bytes in length, followed by optional *extension headers* and then a variable-length *Data* area. This structure was created to allow the main header to be streamlined while allowing devices to add extra information to datagrams when needed.

IPv6 General Datagram Structure

As I mentioned above, IPv6 datagrams now includes a main header format (which has no official name in the standards, it's just “the header”) and zero or more extension headers. The overall structure therefore is as shown in [Table 68](#) and [Figure 104](#).

Table 68: IPv6 General Datagram Structure

Component	Number of Components Per Datagram	Size (bytes)	Description
<i>Main Header</i>	1	40	Contains the source and destination addresses, and important information required for every datagram.
<i>Extension Headers</i>	0 or more	Variable	Each contains one type of extra information to support various features, including fragmentation, source routing, security and options.
<i>Data</i>	1	Variable	The payload from the upper layer to be transmitted in the datagram.

Note that as with IPv4, large payloads may be fragmented prior to encapsulation, to ensure that the total size of the datagram doesn't exceed the maximum size permitted on an underlying network. However, [the details of fragmentation in IPv6 are different than in IPv4](#).

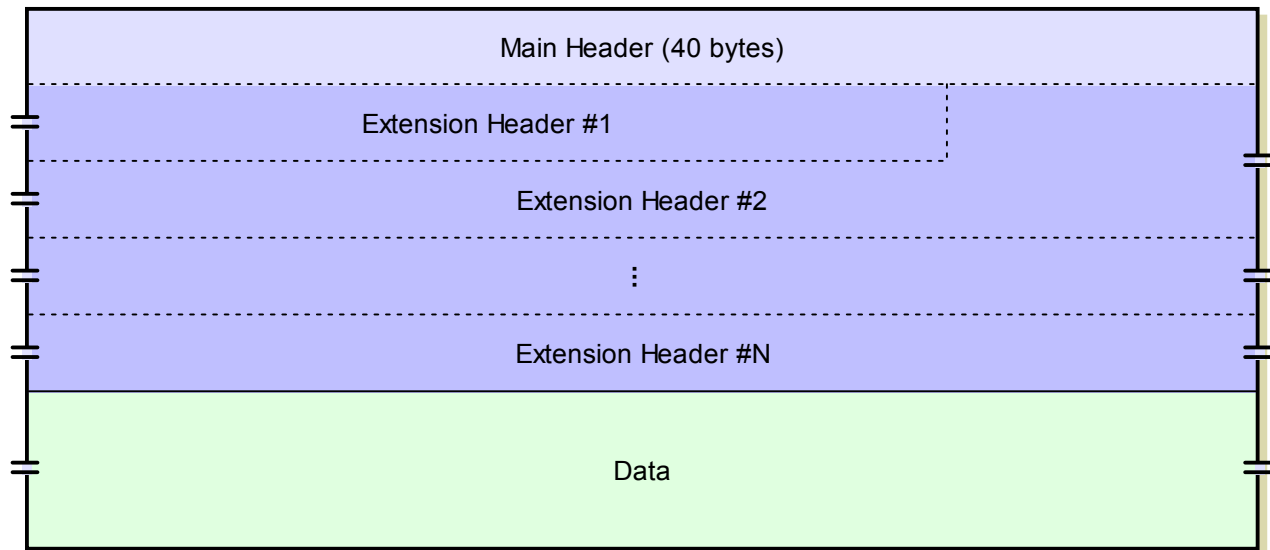

Figure 104: IPv6 General Datagram Structure

IPv6 Datagram Main Header Format

As we saw in [the previous topic](#), IPv6 datagrams use a structure that includes a regular header and optionally, one or more extension headers. This regular header is like [the header of IPv4 datagrams](#), though it has a different format, as we will see shortly. The standards don't give this header a name; it is just "*the IPv6 header*". To differentiate it from IPv6 extension headers, I call it the *main header*.

Main Header Format

The IPv6 main header is required for every datagram. It contains addressing and control information that are used to manage the processing and routing of the datagram. The main header format of IPv6 datagrams is described in [Table 69](#) and illustrated in [Figure 105](#).

Table 69: IPv6 Main Header Format (Page 1 of 2)

Field Name	Size (bytes)	Description
Version	1/2 (4 bits)	Version: Identifies the version of IP used to generate the datagram. This field is used the same way as in IPv4, except of course that it carries the value 6 (0110 binary).
Traffic Class	1	Traffic Class: This field replaces the <i>Type Of Service (TOS)</i> field in the IPv4 header. It is used not in the original way that the TOS field was defined (with Precedence, D, T and R bits) but using the new <i>Differentiated Services (DS)</i> method defined in RFC 2474. That RFC actually specifies quality of service (QOS) techniques for both IPv4 and IPv6; see the IPv4 format description for a bit more information .

Table 69: IPv6 Main Header Format (Page 2 of 2)

Field Name	Size (bytes)	Description
Flow Label	2 1/2 (20 bits)	<p>Flow Label: This large field was created to provide additional support for real-time datagram delivery and quality of service features. The concept of a <i>flow</i> is defined in RFC 2460 as a sequence of datagrams sent from a source device to one or more destination devices. A unique flow label is used to identify all the datagrams in a particular flow, so that routers between the source and destination all handle them the same way, to help ensure uniformity in how the datagrams in the flow are delivered. For example, if a video stream is being sent across an IP internetwork, the datagrams containing the stream could be identified with a flow label to ensure that they are delivered with minimal latency.</p> <p>Not all devices and routers may support flow label handling, and use of the field by a source device is entirely optional. Also, the field is still somewhat experimental and may be refined over time.</p>
Payload Length	2	<p>Payload Length: This field replaces the <i>Total Length</i> field from the IPv4 header, but it is used differently. Rather than measuring the length of the whole datagram, it only contains the number of bytes of the payload. However, if extension headers are included, their length is counted here as well.</p> <p>In simpler terms, this field measures the length of the datagram less the 40 bytes of the main header itself.</p>
Next Header	1	<p>Next Header: This field replaces the <i>Protocol</i> field and has two uses. When a datagram has extension headers, this field specifies the identity of the first extension header, which is the next header in the datagram. When a datagram has just this “main” header and no extension headers, it serves the same purpose as the old IPv4 <i>Protocol</i> field and has the same values, though new numbers are used for IPv6 versions of common protocols. In this case the “next header” is the header of the upper layer message the IPv6 datagram is carrying. See below for more details.</p>
Hop Limit	1	<p>Hop Limit: This replaces the <i>Time To Live (TTL)</i> field in the IPv4 header; its name better reflects the way that <i>TTL</i> is used in modern networks (since <i>TTL</i> is really used to count hops, not time.)</p>
Source Address	16	<p>Source Address: The 128-bit IP address of the originator of the datagram. As with IPv4, this is always the device that originally sent the datagram.</p>
Destination Address	16	<p>Destination Address: The 128-bit IP address of the intended recipient of the datagram; unicast, anycast or multicast. Again, even though devices such as routers may be the intermediate targets of the datagram, this field is always for the ultimate destination.</p>

IPv6 Next Header Field

The *Next Header* field is one of the most important additions to the IPv6 datagram format. When an IPv6 datagram uses extension headers, this field contains an identifier for the first extension header, which in turn uses its own *Next Header* to point to the next header, and so on. The last extension header then references the encapsulated higher-layer protocol—

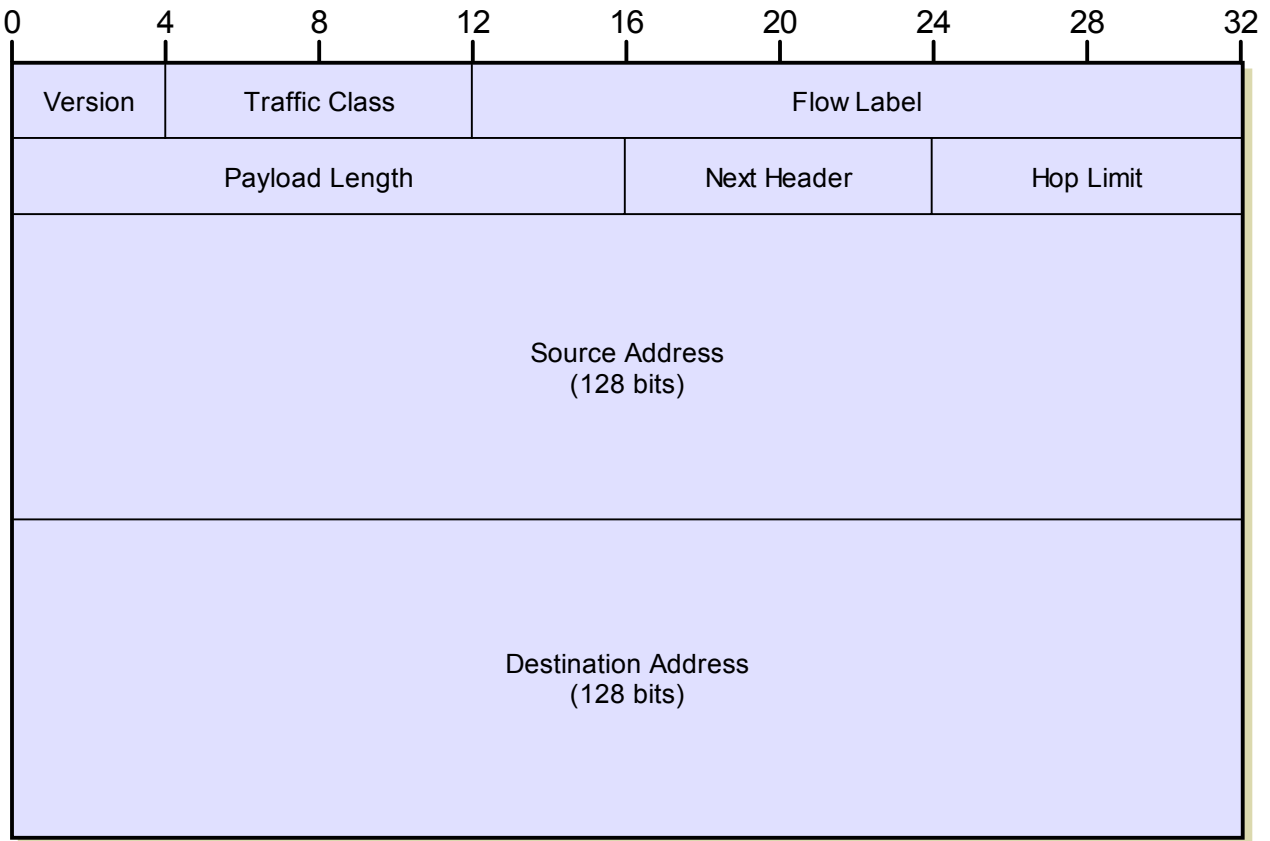

Figure 105: IPv6 Main Header Format

since the higher-layer protocol’s header appears at the start of the IPv6 *Data* field, it is like the “next header” to the device receiving the datagram. For some folks this is a bit tough to see conceptually; much more detail on how the field works (including a useful illustration) can be found in [the next topic, describing extension headers](#). Some of the most common values for *Next Header* in IPv6 are shown in [Table 70](#).

Table 70: Common IPv6 Next Header Values (Page 1 of 2)

Value (Hexadecimal)	Value (Decimal)	Protocol / Extension Header
00	0	Hop-By-Hop Options Extension Header (note that this value was “Reserved” in IPv4)
01	1	ICMPv4
02	2	IGMPv4
04	4	IP in IP Encapsulation
06	6	TCP
08	8	EGP
11	17	UDP
29	41	IPv6

Table 70: Common IPv6 Next Header Values (Page 2 of 2)

Value (Hexadecimal)	Value (Decimal)	Protocol / Extension Header
2B	43	Routing Extension Header
2C	44	Fragmentation Extension Header
2E	46	Resource Reservation Protocol (RSVP)
32	50	Encrypted Security Payload (ESP) Extension Header
33	51	Authentication Header (AH) Extension Header
3A	58	ICMPv6
3B	59	No Next Header
3C	60	Destination Options Extension Header

The total length of the main IPv6 header format is 40 bytes. This is double the size of the IPv4 header without options, largely because of the extra 24 bytes needed for the monstrous IPv6 addresses. There are only 8 bytes of non-address header fields in the IPv6 main header, compared to 12 in the IPv4 header.

Key Changes to Main Header Between IPv4 and IPv6

To summarize, the IPv6 main header compares to the IPv4 header as follows:

- ☉ **Unchanged Fields:** Three fields are used the same way and retain the same name (though they have different content and/or size): *Version*, *Source Address* and *Destination Address*.
- ☉ **Renamed Fields:** Two fields are used the same way but renamed: *Traffic Class* and *Hop Limit*.
- ☉ **Modified Fields:** Two fields are used in a way similar way to their IPv4 predecessors but are slightly different in meaning and also renamed: *Payload Length* and *Next Header*.
- ☉ **Added Fields:** There is one new field: *Flow Label*.
- ☉ **Removed Fields:** To cut down on header length and unnecessary work, five IPv4 header fields are removed from the IPv6 header:
 - ☉ **Internet Header Length:** No longer needed, as the main IPv6 header is fixed in length at 40 bytes.
 - ☉ **Identification, Flags, Fragment Offset:** These are used for fragmentation, which is done less in IPv6 than IPv4, so these fields are now found only when needed in the [Fragmentation extension header](#).
 - ☉ **Header Checksum:** The decision was made to eliminate header checksum calculations in IPv6. It was viewed as redundant with higher-layer error-checking and data link layer CRC calculations. This saves processing time for routers and 2 bytes in the datagram header.

In addition, while options were formerly considered part of the main header in IPv4, [they are separate in IPv6](#).

IPv6 Datagram Extension Headers

After the mandatory “main” header in an IPv6 datagram, one or more *extension headers* may appear before the encapsulated payload. These headers were created in an attempt to provide both flexibility and efficiency in the creation of IPv6 datagrams. All fields that are needed only for special purposes are put into extension headers and placed in the datagram when needed. This allows the size of the main datagram header to be made small and streamlined, containing only those fields that really must be present all the time.

There is often confusion regarding the role of extension headers, especially compared to datagram options. The IPv4 datagram had only one header, but it included a provision for options, and IPv6 also has options, so why bother with extension headers? Good question.

It would have been possible to do everything using options. However, it was deemed a better design to employ extension headers for certain sets of information that are needed for common functions such as fragmenting. Options are indeed still supported in IPv6; they are used to provide even more flexibility by providing variable-length fields that can be used for any purpose. They are themselves defined using extension headers as we will see below (and in [their own topic, which follows.](#))

When extension headers are included in an IPv6 datagram, they appear one after the other following the main header. Each extension header type has its own internal structure of fields.

IPv6 Header Chaining Using the Next Header Field

The only field common to all extension header types is the *Next Header* field (which actually appears at the end of one header type, the [ESP header](#)). The 8-bit *Next Header* field is used to logically link all the headers in an IPv6 datagram as follows:

- ① The *Next Header* field in the main header contains a reference number for the first extension header type.
- ② The *Next Header* field in the first extension header contains the number of the second extension header type, if there is a second one. If there's a third, the second header's *Next Header* points to it, and so on.
- ③ The *Next Header* field of the last extension header contains the protocol number of the encapsulated higher-layer protocol. In essence, this field points to the “next header” within the payload itself.

For example, suppose a datagram that encapsulates TCP has a *Hop-By-Hop Options* extension header and a *Fragment* extension header. Then, the *Next Header* fields of these headers would contain the following values:

- ① The main header would have a *Next Header* value of 0, indicating the *Hop-By-Hop Options* header.
- ② The *Hop-By-Hop Options* header would have a *Next Header* value of 44 (decimal), the value for the *Fragment* extension header.
- ③ The *Fragment* header would have a *Next Header* value of 6.

This is illustrated in [Figure 106](#).

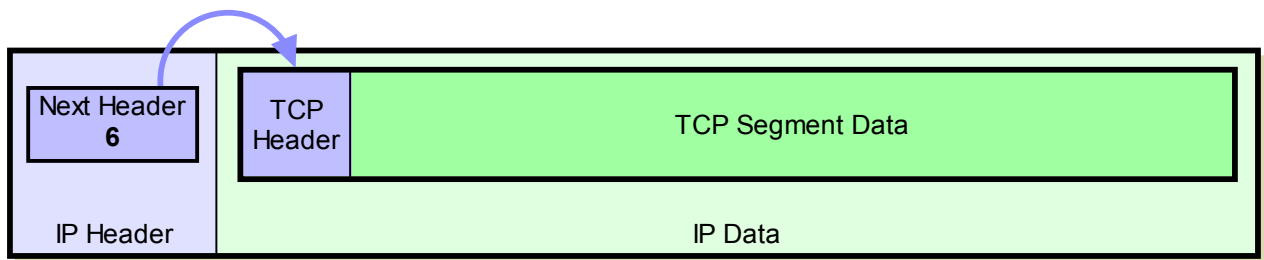

IPv6 Datagram With No Extension Headers Carrying TCP Segment

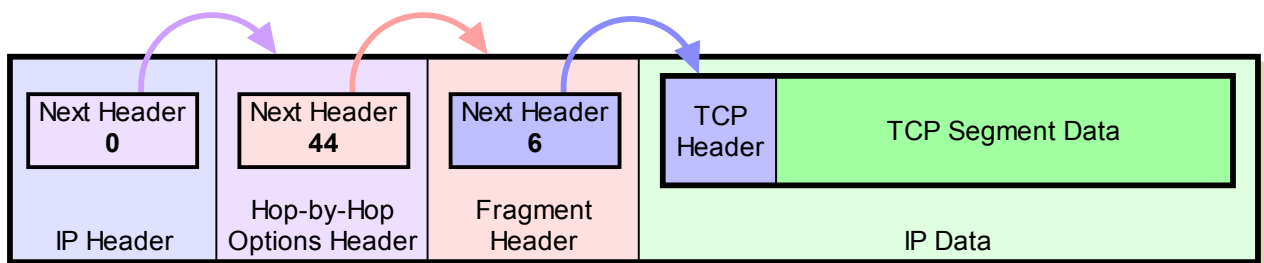

IPv6 Datagram With Two Extension Headers Carrying TCP Segment

Figure 106: IPv6 Extension Header Linking Using the *Next Header* Field

The *Next Header* field allows a device to more easily process the headers in a received IPv6 datagram. When a datagram has no extension headers, the “next header” is actually the header at the start of the IP *Data* field, in this case a TCP header with a value of 6. This is the same way the *Protocol* field is used in IPv4. When extension headers do appear, the *Next Header* value of each header contains a number indicating the type of the following header in the datagram, so they logically “chain together” the headers, as shown above.



Key Concept: The IPv6 *Next Header* field is used to “chain together” the headers in an IPv6 datagram. The *Next Header* field in the main header contains the number of the first extension header; its *Next Header* contains the number of the second, and so forth. The last header in the datagram contains the number of the encapsulated protocol that begins the *Data* field.

Summary of IPv6 Extension Headers

Table 71 lists the different extension headers, showing its *Next Header* value, length and defining RFC, and providing a brief description of how each is used.

Table 71: IPv6 Extension Headers

Next Header Value (decimal)	Extension Header Name	Length (bytes)	Description	Defining RFC
0	Hop-By-Hop Options	Variable	Defines an arbitrary set of options that are intended to be examined by all devices on the path from the source to destination device(s). This is one of two extension headers used to define variable-format options .	2460
43	Routing	Variable	Defines a method for allowing a source device to specify the route for a datagram. This header type actually allows the definition of multiple routing types. The IPv6 standard defines the Type 0 <i>Routing</i> extension header, which is equivalent to the “loose” source routing option in IPv4 and used in a similar way. See below for the format of this extension header.	2460
44	Fragment	8	When a datagram contains only a fragment of the original message, this extension header is included. It contains the <i>Fragment Offset</i> , <i>Identification</i> and <i>More Fragment</i> fields that were removed from the main header. See below for the format of this extension header, and the topic on fragmentation and reassembly for details on how the fields are used.	2460
50	Encapsulating Security Payload (ESP)	Variable	Carries encrypted data for secure communications. This header is described in detail in the section on IPSec.	2406
51	Authentication Header (AH)	Variable	Contains information used to verify the authenticity of encrypted data. This header is described in detail in the section on IPSec.	2402
60	Destination Options	Variable	Defines an arbitrary set of options that are intended to be examined only by the destination(s) of the datagram. This is one of two extension headers used to define variable-format options .	2460

Note that the *Next Header* value of the IPv6 main header is 41; that of an IPv4 header is 4 (its protocol number). Note that there is also a “dummy” extension header called *No Next Header* that has a value of 59. This is a placeholder that when found in the *Next Header* field indicates that there is nothing after that extension header.

As I mentioned in the table, the formats for several of the headers are provided in other topics. Two of them I will describe here, however.

IPv6 Routing Extension Header

The *Routing* extension header is used to perform source routing in IPv6. It is described in [Table 72](#), and illustrated in [Figure 107](#).

Table 72: IPv6 Routing Extension Header Format

Field Name	Size (bytes)	Description
<i>Next Header</i>	1	Next Header: Contains the protocol number of the next header after the Routing header. Used to link headers together as described above.
<i>Hdr Ext Len</i>	1	Header Extension Length: The length of the Routing header in 8-byte units, not including the first 8 bytes of the header. For a Routing Type of 0, this value is thus two times the number addresses embedded in the header.
<i>Routing Type</i>	1	Routing Type: This field allows multiple routing types to be defined; at present, the only value used is 0.
<i>Segments Left</i>	1	Segments Left: Specifies the number of explicitly-named nodes remaining in the route until the destination.
<i>Reserved</i>	4	Reserved: Not used; set to zeroes.
<i>Address1 ... AddressN</i>	Variable (multiple of 16)	Addresses: A set of IPv6 addresses that specify the route to be used.

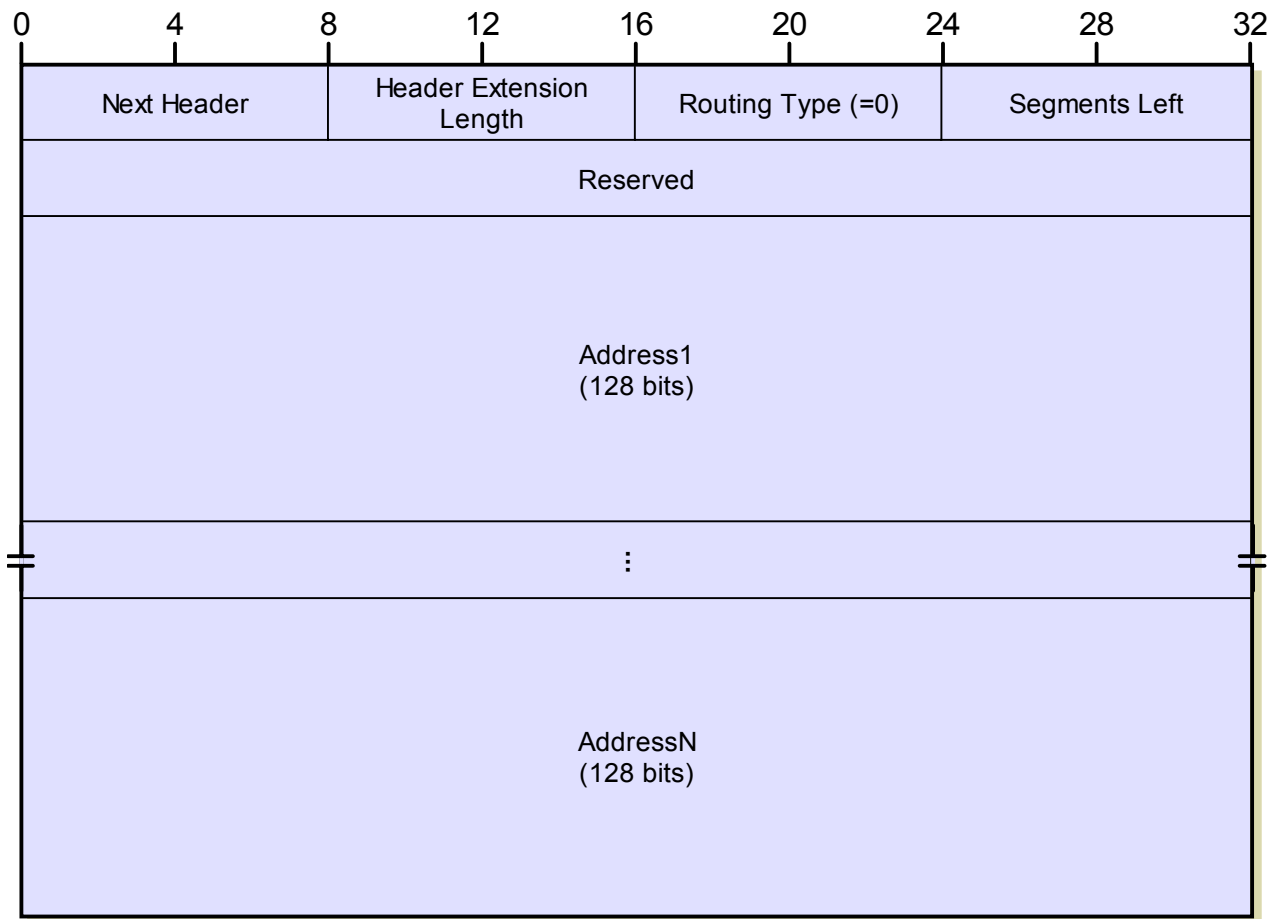

Figure 107: IPv6 Routing Extension Header Format

IPv6 Fragment Extension Header

The *Fragment* extension header is included in fragmented datagrams to provide the information necessary to allow the fragments to be reassembled. Its format can be found in [Table 73](#) and [Figure 108](#).

Table 73: IPv6 Fragment Extension Header Format (Page 1 of 2)

Field Name	Size (bytes)	Description
Next Header	1	Next Header: Contains the protocol number of the next header after the Fragment header. Used to link headers together as described above.
Reserved	1	Reserved: Not used; set to zeroes.
Fragment Offset	13/8 (13 bits)	Fragment Offset: Specifies the offset, or position, in the overall message where the data in this fragment goes. It is specified in units of 8 bytes (64 bits) and used in a manner very similar to the field of the same name in the IPv4 header.

Table 73: IPv6 *Fragment* Extension Header Format (Page 2 of 2)

Field Name	Size (bytes)	Description
Res	1/4 (2 bits)	Reserved: Not used; set to zeroes.
M Flag	1/8 (1 bit)	More Fragments Flag: Same as the flag of the same name in the IPv4 header—when set to 0, indicates the last fragment in a message; when set to 1, indicates that more fragments are yet to come in the fragmented message.
Identification	4	Identification: Same as the field of the same name in the IPv4 header, but expanded to 32 bits. It contains a specific value that is common to each of the fragments belonging to a particular message, to ensure that pieces from different fragmented messages are not mixed together.

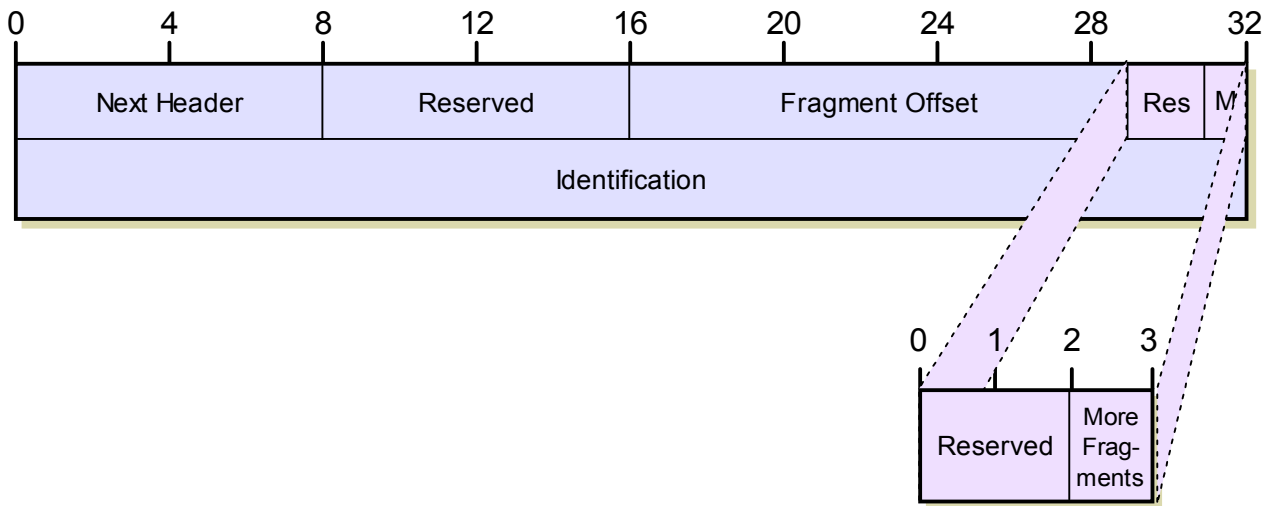

Figure 108: IPv6 *Fragment* Extension Header Format

IPv6 Extension Header Order

Each extension header appears only once in any datagram (with one exception; see below). Also, extension headers are only examined by the final recipients of the datagram, not intermediate devices (again with one exception, which we will get to momentarily). RFC 2460 specifies that when multiple headers appear, they should be in the following order after the main header and before the higher-layer encapsulated header in the IPv6 datagram payload:

1. *Hop-By-Hop Options*
2. *Destination Options* (for options to be processed by the destination as well as devices specified in a Routing header)
3. *Routing*
4. *Fragmentation*

-
5. *Authentication Header*
 6. *Encapsulating Security Payload*
 7. *Destination Options* (for options processed only by the final destination)

Now let's look at those exceptions. The only header that can appear twice is *Destination Options*. Normally, it appears as the last header. However, a *Destination Options* header may exist that contain options that must be examined by a list of devices specified in a source route, in addition to the destination. In this case, the *Destination Options* header for these options is placed before the *Routing* header. A second such header containing options only for the final destination may also appear.



Key Concept: Each extension header may appear only once in an IPv6 datagram, and they must appear in a fixed order. The exception is the *Destination Options* header, which may appear twice; near the start of the datagram for options to be processed by devices en route to the destination, and at the end of the extension headers for options intended only for the final destination.

The only header normally examined by all intermediate devices is the *Hop-By-Hop Options* extension header. It is used specifically to convey management information to all routers in a route. The *Hop-By-Hop Options* extension header must appear as the first extension header if present. Since it is the only one that must be read by every router (which represents a performance drain on routers) it is given “top billing” to make it easier and faster to find and process.

Finally, note that all extension headers must be a multiple of 8 bytes in length for alignment purposes. Also, remember that the *Next Header* value for a particular extension header appears in the *Next Header* field of the *preceding* header, not the header itself.

IPv6 Datagram Options

In IPv4, all “extra” information required for various purposes is placed into the datagram in the form of [options that appear in the IPv4 header](#). In IPv6, the new concept of [extension headers](#) is introduced; these headers take the place of many of the predefined IPv4 options. However, the concept of options is still maintained in IPv6, for a slightly different purpose. Options allow the IPv6 datagram to be supplemented with arbitrary sets of information that aren't defined in the regular extension headers. They provide maximum flexibility, allowing the basic IPv6 protocol to be extended in ways the designers never anticipated, with the goal of reducing the chances of the protocol becoming obsolete.

IPv6 Option Extension Header Types

I said that IPv6 options supplement extension headers; in fact, they are actually implemented as extension headers. There are two different ones used to encode options. These two headers only differ in terms of how the options they contain are to be processed by devices; otherwise, they are formatted the same and used in the same way.

The two extension header types are:

- ☉ **Destination Options:** Contains options that are intended only for the ultimate destination of the datagram (and perhaps a set of routers specified in a Routing header, if present).
- ☉ **Hop-By-Hop Options:** Contains options that carry information for every device (router) between the source and destination

IPv6 Option Format

Each of these header types has a one-byte *Next Header* field, and a one-byte *Header Extension Length* field that indicates the header's overall length. The rest of the header has one or more option fields. [Figure 109](#) illustrates the overall format of these two headers. The format of each option is similar to that of IPv4 options, and is shown in [Table 74](#).

Table 74: IPv6 Option Format (Page 1 of 2)

Subfield Name	Size (bytes)	Description																						
<i>Option Type</i>	1	<p>Option Type: This field indicates the type of option. The bits are interpreted according to the following "sub-subfield" structure:</p> <table border="1"> <thead> <tr> <th>Sub-Subfield Name</th> <th>Size (bytes)</th> <th>Description</th> </tr> </thead> <tbody> <tr> <td><i>Unrecognized Option Action</i></td> <td>2/8 (2 bits)</td> <td> <p>The first two bits specify what action should be taken if the device processing the option doesn't recognize the Option Type. The four values are:</p> <table border="1"> <thead> <tr> <th>Value</th> <th>Action on Unrecognized Option</th> </tr> </thead> <tbody> <tr> <td>00</td> <td>Skip option; process rest of header.</td> </tr> <tr> <td>01</td> <td>Discard datagram; do nothing else.</td> </tr> <tr> <td>10</td> <td>Discard datagram and send an ICMP Parameter Problem message with code 2 back to the datagram source.</td> </tr> <tr> <td>11</td> <td>Discard datagram and send the above ICMP message, only if destination was not a multicast address.</td> </tr> </tbody> </table> </td> </tr> <tr> <td><i>Option Change Allowed Flag</i></td> <td>1/8 (1 bit)</td> <td>Set to 1 if the Option Data can change while the datagram is en route, or left at 0 if it cannot.</td> </tr> <tr> <td><i>Remainder of Option Type</i></td> <td>5/8 (5 bits)</td> <td>Five remaining bits that allow the specification of 32 different combinations for each combination of the three bits above.</td> </tr> </tbody> </table>	Sub-Subfield Name	Size (bytes)	Description	<i>Unrecognized Option Action</i>	2/8 (2 bits)	<p>The first two bits specify what action should be taken if the device processing the option doesn't recognize the Option Type. The four values are:</p> <table border="1"> <thead> <tr> <th>Value</th> <th>Action on Unrecognized Option</th> </tr> </thead> <tbody> <tr> <td>00</td> <td>Skip option; process rest of header.</td> </tr> <tr> <td>01</td> <td>Discard datagram; do nothing else.</td> </tr> <tr> <td>10</td> <td>Discard datagram and send an ICMP Parameter Problem message with code 2 back to the datagram source.</td> </tr> <tr> <td>11</td> <td>Discard datagram and send the above ICMP message, only if destination was not a multicast address.</td> </tr> </tbody> </table>	Value	Action on Unrecognized Option	00	Skip option; process rest of header.	01	Discard datagram; do nothing else.	10	Discard datagram and send an ICMP Parameter Problem message with code 2 back to the datagram source.	11	Discard datagram and send the above ICMP message, only if destination was not a multicast address.	<i>Option Change Allowed Flag</i>	1/8 (1 bit)	Set to 1 if the Option Data can change while the datagram is en route, or left at 0 if it cannot.	<i>Remainder of Option Type</i>	5/8 (5 bits)	Five remaining bits that allow the specification of 32 different combinations for each combination of the three bits above.
		Sub-Subfield Name	Size (bytes)	Description																				
		<i>Unrecognized Option Action</i>	2/8 (2 bits)	<p>The first two bits specify what action should be taken if the device processing the option doesn't recognize the Option Type. The four values are:</p> <table border="1"> <thead> <tr> <th>Value</th> <th>Action on Unrecognized Option</th> </tr> </thead> <tbody> <tr> <td>00</td> <td>Skip option; process rest of header.</td> </tr> <tr> <td>01</td> <td>Discard datagram; do nothing else.</td> </tr> <tr> <td>10</td> <td>Discard datagram and send an ICMP Parameter Problem message with code 2 back to the datagram source.</td> </tr> <tr> <td>11</td> <td>Discard datagram and send the above ICMP message, only if destination was not a multicast address.</td> </tr> </tbody> </table>	Value	Action on Unrecognized Option	00	Skip option; process rest of header.	01	Discard datagram; do nothing else.	10	Discard datagram and send an ICMP Parameter Problem message with code 2 back to the datagram source.	11	Discard datagram and send the above ICMP message, only if destination was not a multicast address.										
		Value	Action on Unrecognized Option																					
00	Skip option; process rest of header.																							
01	Discard datagram; do nothing else.																							
10	Discard datagram and send an ICMP Parameter Problem message with code 2 back to the datagram source.																							
11	Discard datagram and send the above ICMP message, only if destination was not a multicast address.																							
<i>Option Change Allowed Flag</i>	1/8 (1 bit)	Set to 1 if the Option Data can change while the datagram is en route, or left at 0 if it cannot.																						
<i>Remainder of Option Type</i>	5/8 (5 bits)	Five remaining bits that allow the specification of 32 different combinations for each combination of the three bits above.																						

Table 74: IPv6 Option Format (Page 2 of 2)

Subfield Name	Size (bytes)	Description
<i>Opt Data Len</i>	1	Option Data Length: Specifies the length of the <i>Option Data</i> subfield below. Note that this is a change in semantics from IPv4, where the length field indicated the size of the entire option; in IPv6 the length of the <i>Option Type</i> and <i>Option Data Length</i> fields are not included.
<i>Option Data</i>	Variable	Option Data: The data to be sent as part of the option, which is specific to the option type. Also sometimes referred to as the <i>Option Value</i> .

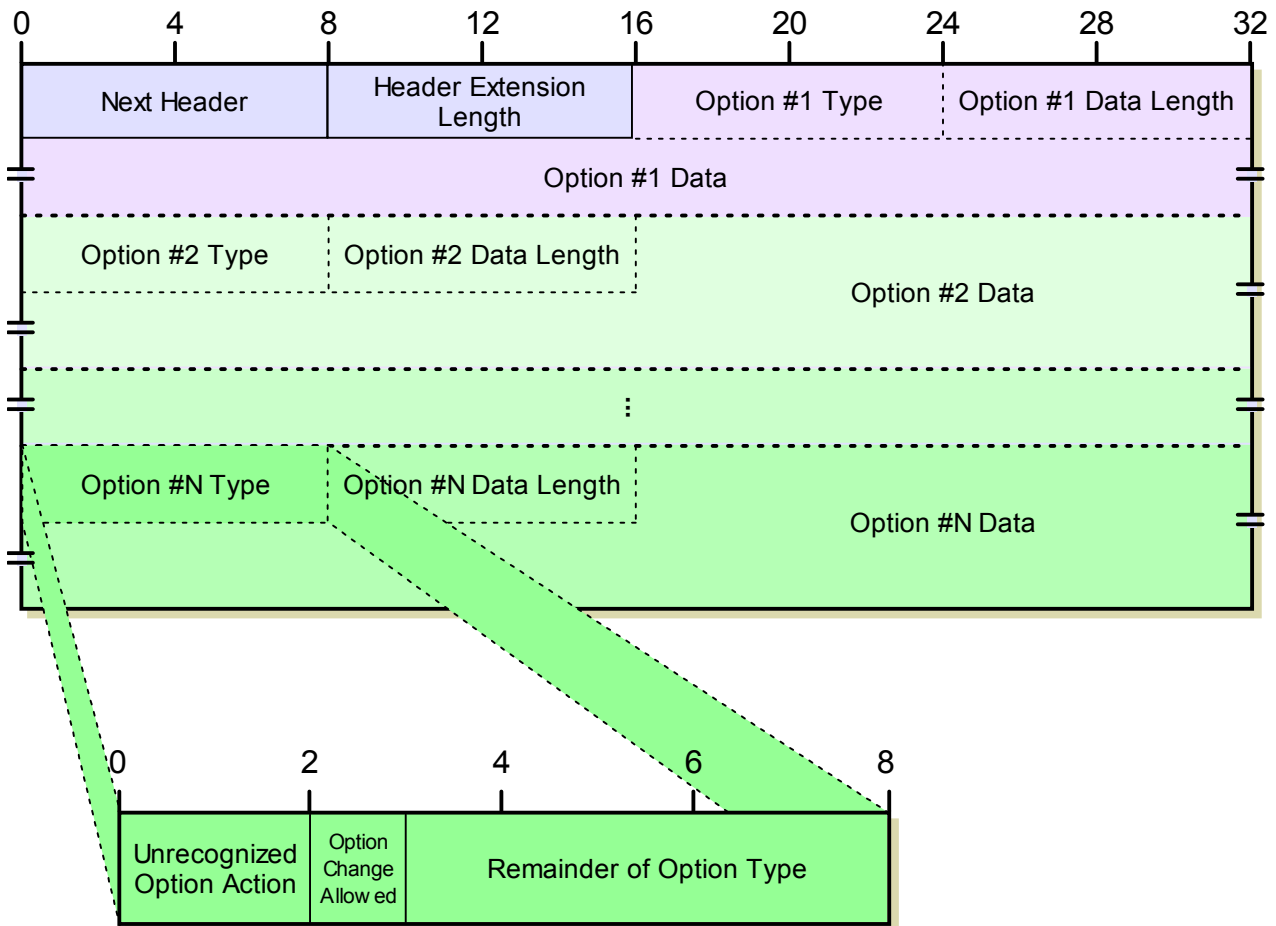

Figure 109: IPv6 Hop-By-Hop Options and Destination Options Header Formats

Each of these extension headers begins with two fixed fields, *Next Header* and *Header Extension Length*. The rest of the header consists of a sequence of variable-length options. Each option has the structure shown in [Table 74](#), consisting of a type / length / value triplet.



Note: The *Option Type* subfield is a bit strange in terms of how it is interpreted. Even though it has a substructure with three sub-subfields as shown in [Table 74](#), that structure is “informal”. What I mean by this is that the 8 bits of this field are taken as a single entity. Despite the special meaning of the three highest-order bits, the **entire field** is called the *Option Type*, not just the last five bits, and the whole is used as a single value from 0 to 255. In fact, the “sub-subfield” names aren't even specified in the standard; I made them up to help explain these fields.

Since each option has a subfield for type, length and value (data), they are sometimes said to be *TLV-encoded*. If there are multiple options, they are placed one after each other in the header. At the end of all the options in a *Hop-By-Hop Options* or *Destination Options* extension header, padding may be placed to ensure that the header is a multiple of 8 bytes in length.



Key Concept: Two IPv6 extension header types, *Hop-By-Hop Options* and *Destination Options*, are used to carry arbitrary optional information in IPv6 datagrams. Each consists of a set of variable-length options that are defined using three subfields indicating the option's type, length and value.



IPv6 Datagram Size, Maximum Transmission Unit (MTU), Fragmentation and Reassembly

The job of the Internet Protocol is to convey messages across an internet of connected networks. When datagrams are sent between hosts on distant networks they are carried along their journey by routers, one hop at a time, over many physical network links. On each step of this journey the datagram is encoded in a data link layer frame for transmission.

Overview of IPv6 Datagram Sizing and Fragmentation

In order for a datagram to be successfully carried along a route, its size must be small enough to fit within the lower-layer frame at each step on the way. The term *maximum transmission unit (MTU)* describes the size limit for any given physical network. If a datagram is too large for the MTU of a network, it must be broken into pieces, a process called *fragmentation*, and then the pieces *reassembled* at the destination device. This has been a requirement since IPv4, and [I explain the concepts and issues related to datagram size, MTUs, fragmentation and reassembly in detail in a section devoted to these matters in IPv4.](#)

All of these issues apply to sending datagrams in IPv6 as much as they did in IPv4. However, as in other areas of the protocol, some important details of how fragmentation and reassembly are done have changed. These changes were made to improve the efficiency of the routing process, and also to reflect the realities of current networking technologies: most can handle average IP datagrams without needing fragmentation.

The most important differences between IPv4 and IPv6 with respect to datagram size, MTU, fragmentation and reassembly are:

- ☉ **Increased Default MTU:** In IPv4, the minimum MTU that routers and physical links were required to handle was 576 bytes. In IPv6, all links must handle a datagram size of at least 1280 bytes. This more-than-doubling in size improves efficiency by increasing the ratio of maximum payload to header length, and reduces the frequency with which fragmentation is required.
- ☉ **Elimination of En Route Fragmentation:** In IPv4, datagrams may be fragmented by either the source device, or by routers during delivery. In IPv6, only the source node can fragment; routers do not. The source must therefore fragment to the size of the smallest MTU on the route before transmission. This has both advantages and disadvantages, as we will see. Reassembly is of course still done only by the destination, as in IPv4.
- ☉ **MTU Size Error Feedback:** Since routers cannot fragment datagrams, they must drop them if they are forced to try to send a too-large datagram over a physical link. A feedback process has been defined using ICMPv6 that lets routers tell source devices that they are using datagrams that are too large for the route.
- ☉ **Path MTU Discovery:** Since source devices must decide on the correct size of fragments, it is helpful if they have a mechanism for determining what this should be. This capability is provided through a special technique called *Path MTU Discovery*, which was originally defined for IPv4 but has been refined for IPv6.

-
- ① **Movement of Fragmentation Header Fields:** To reflect the decreased importance of fragmentation in IPv4, the permanent fields related to the process that were in the IPv4 header have been farmed out to a *Fragment* extension header, included only when needed.

Implications of IPv6's "Source Only" Fragmentation Rule

I find the changes in the fragmentation and reassembly process interesting. While many other changes in IPv6 represent a shift in “responsibility” for functions from host devices to routers, this one is the opposite. In IPv4, a source node can really send a datagram of any size its local link can handle, and let the routers take care of fragmenting it as needed. This seems like a sensible model; nodes communicate on a large “virtual” network and the details of splitting messages as needed for physical links are handled invisibly.

The problem with this is that it represents a performance drag on routing. It is much faster for a router to forward a datagram intact than to spend time fragmenting it. In some cases, fragmentation would have to occur multiple times during transmission of a datagram, and remember that this must happen for **every** datagram on a route. It is a lot more efficient for the source to just send datagrams that are the right size in the first place.

Determining the Appropriate Datagram Size

Of course, there's a problem here: how does the source know what size to use? It has no idea of the physical networks used by the route datagrams will take to a destination; in fact, it doesn't even know what the routes **are!** It has two choices:

1. **Use Default MTU:** The first option is simply to use the default MTU of 1280, which all physical networks must be able to handle. This is a good choice especially for short communications or for sending small amounts of data.
2. **Use Path MTU Discovery:** The alternative is to make use of the *Path MTU Discovery* feature, described below. This method, defined in RFC 1981, defines a method whereby a node sends messages over a route to determine what the overall minimum MTU for the path is, in a technique very similar to [how it is done in IPv4](#).

Since routers can't fragment in IPv6, if a datagram is sent by a source that is too large for a router, it must drop the datagram. It will then send back to the source feedback about this occurrence, in the form of an [ICMPv6 Packet Too Big](#) message. This tells the source that its datagram was dropped and that it must fragment (or reduce the size of its fragments.)

This feedback mechanism is also used in discovering path MTUs. The source node sends a datagram that has the MTU of its local physical link, since that represents an upper bound on the MTU of the path. If this goes through without any errors, it knows it can use that value for future datagrams to that destination. If it gets back any *Packet Too Big* messages, it tries again using a smaller datagram size. The advantage of this over the default of 1280 is that it may allow a large communication to proceed with a higher MTU, to improve performance.

One drawback of the decision to only fragment at the source is that it introduces the potential for problems if there is more than one route between devices or if routes change. In IPv4, fragmentation is dynamic and automatic; it happens on its own and adjusts as routes change. Path MTU Discovery is a good feature, but it is static. It requires that hosts keep track of MTUs for different routes, and update them regularly. This is done by redoing path MTU discovery if a node receives a *Packet Too Big* message on a route for which it has previously performed path MTU discovery, but this takes time.



Key Concept: In IPv6 fragmentation is only performed by the device sending a datagram, not by routers. If a router encounters a datagram too large to send over a physical network with a small MTU, the router sends an ICMPv6 *Packet Too Big* message back to the source of the datagram. This can be used as part of a process called *Path MTU Discovery* to determine the minimum MTU of an entire route.

IPv6 Fragmentation Process

The actual mechanics of fragmentation in IPv6 are similar to those in IPv4, with the added complication that extension headers must be handled carefully. For purposes of fragmentation, IPv6 datagrams are broken into two pieces:

- **Unfragmentable Part:** This includes the main header of the original datagram, as well as any extension headers that need to be present in each fragment. This means the main header, and any of the following headers if present: *Hop-By-Hop Options*, *Destination Options* (for those options to be processed by devices along a route) and *Routing*.
- **Fragmentable Part:** This includes the data portion of the datagram, along with the other extension headers if present—*Authentication Header*, *Encapsulating Security Payload* and/or *Destination Options* (for options to be processed only by the final destination).

The *Unfragmentable Part* must be present in each fragment, while the fragmentable part is split up amongst the fragments. So to fragment a datagram, a device creates a set of fragment datagrams, each of which contains the following, in order:

1. **Unfragmentable Part:** The full *Unfragmentable Part* of the original datagram, with its *Payload Length* changed to the length of the fragment datagram.
2. **Fragment Header:** A *Fragment* header with the *Fragment Offset*, *Identification* and *M* flags set in the same way they are used in IPv4.
3. **Fragment:** A fragment of the *Fragmentable Part* of the original datagram. Note that each fragment must have a length that is a multiple of 8 bytes, because the value in the *Fragment Offset* field is specified in multiples of 8 bytes.



Key Concept: Fragmentation is done in IPv6 in a manner similar to that of IPv4, except that extension headers must be handled specially. Certain extension headers are considered *unfragmentable* and appear in each fragment; others are fragmented along with the data.

IPv6 Fragmentation Example

Let's take an example to illustrate how IPv6 fragmentation works (see [Figure 110](#)). Suppose we have an IPv6 datagram exactly 370 bytes wide, consisting of a 40-byte IP header, four 30-byte extension headers, and 210 bytes of data. Two of the extension headers are unfragmentable, while two are fragmentable. (In practice we would never need to fragment such a small datagram but I am trying to keep the numbers simple.) Suppose we need to send this over a link with an MTU of only 230 bytes. We would actually require three fragments, not the two you might expect, because of the need to put the two 30-byte unfragmentable extension headers in each fragment, and the requirement that each fragment be a length that is a multiple of 8. Here is how the fragments would be structured:

1. **First Fragment:** The first fragment would consist of the 100-byte *Unfragmentable Part*, followed by an 8-byte *Fragment* header and the first 120 bytes of the *Fragmentable Part* of the original datagram. This would contain the two fragmentable extension headers and the first 60 bytes of data. This leaves 150 bytes of data to send.
2. **Second Fragment:** This would also contain the 100-byte *Unfragmentable Part*, followed by a *Fragment* header and 120 bytes of data (bytes 60 to 179). This would leave 30 bytes of data remaining.
3. **Third Fragment:** The last fragment would contain the 100-byte *Unfragmentable Part*, a *Fragment* header and the final 30 bytes of data.

The “M” (*More Fragments*) flag would be set to one in the first two fragments and zero in the third, and the *Fragment Offset* values would be set appropriately. [See the topic on IPv4 fragmentation for more on how these fields are used.](#)

The receiving device reassembles by taking the *Unfragmentable Part* from the first fragment and then assembling the *Fragment* data from each fragment in sequence.



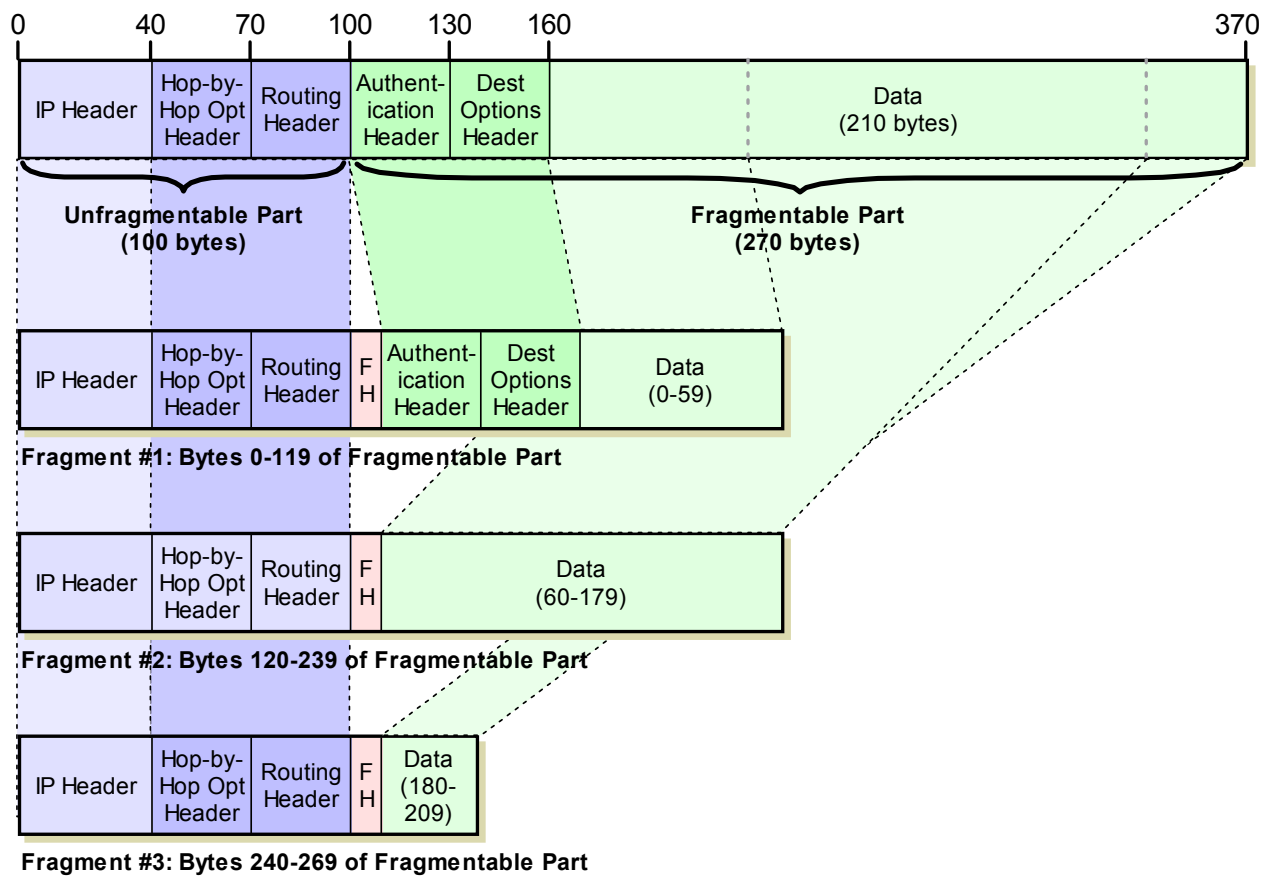

Figure 110: IPv6 Datagram Fragmentation

In this illustration, a 370-byte IPv6 datagram, containing four 30-byte extension headers, is broken into three fragments. The sizes of the fields are shown to scale. The *Unfragmentable Part*, shown in blue, begins each fragment, followed by the *Fragment* header (abbreviated as “FH” in the figure). Then, portions of the *Fragmentable Part* are placed into each fragment in sequence. The *Authentication* and *Destination Options* extension headers are part of the *Fragmentable Part* so they appear as part of the first fragment.

IPv6 Datagram Delivery and Routing

IP functions such as addressing, datagram encapsulation and if necessary, fragmentation and reassembly, all lead up to the ultimate objective of the protocol: the actual *delivery* of datagrams from a source device to one or more destination devices.

Unchanged Aspects of Datagram Delivery and Routing in IPv6

Most of the concepts related to how datagram delivery is accomplished in IPv6 are [the same as in IPv4](#):

- ☉ Datagrams are delivered directly when the source and destination nodes are on the same network. When they are on different networks, delivery is indirect using routing to the destination's network, and then direct to the destination.
- ☉ [Routing](#) is performed by looking at IP addresses and determining which portion is the network ID and which the host ID. IPv6 does this in the same basic way as in classless IPv4, despite the fact that IPv6 unicast addresses are assigned using a special hierarchical format.
- ☉ [Routing is still done on a next-hop basis](#), with sources generally not knowing how datagrams get from Point A to Point B.
- ☉ Routing is performed by devices called *routers* that maintain [tables of routes](#) that tell them where to forward datagrams to reach different destination networks.
- ☉ [Routing protocols](#) are used to allow routers to exchange information about routes and networks.

Changes in Datagram Delivery and Routing in IPv6

Most of the changes in routing in IPv6 are directly related to changes that we have seen in other areas of the protocol. Some of the main issues of note related to routing and routers in IPv6 include the following:

- ☉ **Hierarchical Routing and Aggregation:** One of the goals of the structure used for organizing unicast addresses was to improve routing. The [unicast addressing format](#) is designed to provide a better match between addresses and Internet topology, and to facilitate route aggregation. Classless addressing using CIDR in IPv4 was an improvement, but lacked any formal mechanism for creating a scalable hierarchy.
- ☉ **Scoped Local Addresses:** [Local-use addresses](#) including site-local and link-local are defined in IPv6, and routers must be able to recognize them. They must route them or *not* route them when appropriate. Multicast addresses also have various levels of scope.
- ☉ **Multicast and Anycast Routing:** [Multicast](#) is standard in IPv6, not optional as in IPv4, so routers must support it. [Anycast addressing](#) is a new type of addressing in IPv6.
- ☉ **More Support Functions:** Capabilities must be added to routers to support new features in IPv6. For example, routers play a key role in implementing [serverless autoconfiguration](#) and [path MTU discovery](#) in the new IPv6 fragmentation scheme.
- ☉ **New Routing Protocols:** Routing protocols such as [RIP](#) must be updated to support IPv6.

-
- ☛ **Transition Issues:** Last but certainly not least, routers play a major role in supporting [the transition from IPv4 to IPv6](#). They will be responsible for connecting together IPv6 “islands” and performing translation to allow IPv4 and IPv6 devices to communicate with each other during the multi-year migration to the new protocol.



IP Network Address Translation (NAT) Protocol

To help extend the life of the [IPv4 addressing scheme](#) while the newer [IPv6 protocol](#) is developed and deployed, other technologies have been developed. One of the most important of these is *IP Network Address Translation*. This technology allows a small number of public IP addresses to be shared by a large number of hosts using private addresses. This essential little “trick” allows the global Internet to actually have far more hosts on it than its address space would normally support. At the same time, it provides some security benefits by making hosts more difficult to address directly by foreign machines on the public Internet.

In this section I provide a description of the concepts behind IP NAT and an explanation of operation of IP NAT types. I begin with an overview of the protocol and discussion of its advantages and disadvantages. I describe the address terminology that you need to know to understand how NAT functions and the differences between various translation techniques. I explain the way that address mappings are performed and the difference between static and dynamic address mapping.

I then explain the operation of the four main types of NAT:

1. *Unidirectional NAT* (also called outbound or traditional NAT)
2. *Bidirectional* (inbound or “two-way”) NAT
3. *Port-Based* or “*Overloaded*” NAT (also called *NAPT* or *PAT*)
4. “*Overlapping*” NAT (also called “*Twice NAT*”).

I conclude with a bit more information on compatibility issues associated with NAT.

Incidentally, most people just call this technology “Network Address Translation” without the “IP”. However, this sounds to me rather generic, and since the version being discussed here is specific to IP, I prefer to make it clear that this is an IP feature. That said, for simplicity I often just say “NAT” too, since that’s shorter. I should also point out that there are quite a few people who don’t consider NAT to be a “protocol” in the strictest sense of the word.



Note: NAT was developed in large part to deal with the address shortage problem in IPv4, so it is associated and used with IPv4. It is possible to implement an IPv6-compatible version of NAT, but address translation isn't nearly as important in IPv6, which was designed to give every TCP/IP device its own unique address. For this reason I focus in this section on the use of NAT with IPv4.

IP NAT Overview, Motivation, Advantages and Disadvantages

The decision to make IP addresses only 32 bits long as part of the original design of the Internet Protocol led to a serious problem when the Internet exploded in popularity beyond anyone's expectations: [exhaustion of the address space](#). [Classless addressing](#) helped

make better use of the address space, and IPv6 was created to ensure that we will never run out of addresses again. However, classless addressing has only slowed the consumption of the IPv4 address space, and IPv6 has taken years to develop and will require years more to deploy.

The shortage of IP addresses promised to grow critical by the end of the 1990s unless some sort of solution was implemented until the transition to IPv6 was completed. Creative engineers on the [Internet Engineering Task Force \(IETF\)](#) were up to the challenge. They created a technique that would not only forestall the depletion of the address space but could also be used to address two other growing issues in the mid-to-late 1990s:

- ① **Increasing Cost of IP Addresses:** As any resource grows scarce, it becomes more expensive. Even when IP addresses were available, it cost more to get a larger number from a service provider than a smaller number. It was desirable to conserve them not only for the sake of the Internet as a whole, but to save money.
- ② **Growing Concerns Over Security:** As Internet use increased in the 1990s, more “bad guys” started using the network also. The more machines a company had directly connected to the Internet, the greater their potential exposure to security risks.

Indirect Internet Connectivity

One solution to the problems of IP address space and security was to set up a system where a company's network was not connected directly to the Internet, but rather ***indirectly***. Setting up a network this way is possible due to several important characteristics of how most organizations use the Internet:

- ① **Most Hosts Are Client Devices:** The Internet is client/server based, and the majority of hosts are clients. Client devices generally don't need to be made publicly accessible. For example, when using your local PC to access the World Wide Web, you issue requests to servers and they respond back, but servers don't have any reason to try to initiate contact with you. Most correspondence is begun by clients and not servers, by definition.
- ② **Few Hosts Access The Internet Simultaneously:** When you have a large number of hosts on the same network connected to the Internet, at any given time usually only a small number of them are trying to access the 'net. It isn't necessary to assume they will all need to access servers at once. Even while you actively browse the Web, you pause for a number of seconds to read information from time to time; you are only accessing the Web server for the time it takes to perform a transaction.
- ③ **Internet Communications Are Routed:** Communications between an organization's network and the Internet go through a router, which acts as a “control point” for traffic flows.

The best way to explain why these attributes matter is to draw an analogy to how telephones are used in an organization, because many of the same attributes apply there. Most of the telephones in a typical organization are used to let employees make phone calls out. Usually there is no need to have any way to call employees directly; instead one system or person can handle all incoming calls. Only a few employees are ever making a call to the “outside world” at any given time. And all calls are routed through a central point that manages the telephone system.

For these reasons, to save money, organizations don't run separate public telephone lines to every employee's desk. Instead, it sets up a telephone system where each employee gets an *extension*, which is basically a local telephone number valid only within the organization. A small number of outside lines is made available in a pool for employees to share, and the telephone system matches the inside extensions to the outside lines as needed. A voice mail system and/or human receptionist handle routing of calls in to the organization.

(Yes, some companies have a direct mapping between extension numbers and real telephone numbers. Don't make trouble. ☺)

Overview of IP Network Address Translation (NAT)

A very similar technique can be used for connecting an organization's computers to the Internet. In TCP/IP networks, this technology was first formalized in RFC 1631, *The IP Network Address Translator (NAT)*, adopted in May 1994. The word “translator” refers to the device (router) that implements NAT. More commonly, the technology as a whole is called *IP Network Address Translation (IP NAT or NAT)*.



Note: The document status of RFC 1631 is “informational”. This means that technically, IP NAT is not an official Internet standard.

A basic implementation of NAT involves setting up an organization's internal network using one of the [private addressing ranges set aside for local IP networks](#). One or more public (Internet) addresses are also assigned to the organization as well, and one or more NAT-capable routers are installed between the local network and the public Internet. The public IP addresses are like “outside lines” in the telephone system, and the private addresses are like “internal extensions”.

The NAT router plays the role of telephone system computer and receptionist. It maps internal extensions to outside lines as needed, and also handles “incoming calls” when required. It does this by not just routing IP datagrams but **modifying** them as needed, translating addresses in datagrams from the private network into public addresses for transmission on the Internet, and back again.

Over time, newer versions of NAT have also been created that solve other problems or provide additional capabilities. *Port-Based NAT* allows sharing of even more hosts on a limited number of IP addresses, by letting two or more devices share one IP address at a time. So-called “*Twice NAT*” helps with the implementation of virtual private networks (VPN) by translating both source and destination addresses in both incoming and outgoing datagrams.



Key Concept: *IP Network Address Translation (IP NAT or NAT)* is a technique that allows an organization to set up a network using private addresses, while still being able to communicate on the public Internet. A NAT-capable router translates private to public addresses and vice-versa as needed. This allows a small number of public IP addresses to be shared amongst a large number of devices, and provides other benefits as well (but also has some drawback).

Advantages of NAT

NAT is one of those technologies that has a long list of both advantages **and** disadvantages. This means it can be extremely useful in a variety of scenarios, but also problematic in others. The main advantages are:

- ☉ **Public IP Address Sharing:** A large number of hosts can share a small number of public IP addresses. This saves money and also conserves IP address space.
- ☉ **Easier Expansion:** Since local network devices are privately addressed and a public IP address isn't needed for each one, it is easy to add new clients to the local network.
- ☉ **Greater Local Control:** Administrators get all the benefits of control that come with a private network, but can still connect to the Internet.
- ☉ **Greater Flexibility In ISP Service:** Changing the organization's Internet Service Provider (ISP) is easier because only the public addresses change. It isn't necessary to renumber all the client machines on the network.
- ☉ **Increased Security:** The NAT translation represents a level of indirection. Thus, it automatically creates a type of firewall between the organization's network and the public Internet. It is more difficult for any client devices to be accessed directly by someone malicious because the clients don't have publicly-known IP addresses.
- ☉ **(Mostly) Transparent:** NAT implementation is mostly transparent, because the changes take place in one or perhaps a few routers. The dozens or hundreds of hosts themselves don't need to be changed.

Disadvantages of NAT

The above are all good reasons to use NAT, but there are drawbacks to the technique as well. Some of these take away part of the benefit in certain items in the list above:

- ☉ **Complexity:** NAT represents one more complexity in setting up and managing the network. It also makes troubleshooting more confusing due to address substitutions.
- ☉ **Problems Due to Lack of Public Addresses:** Certain functions won't work properly due to lack of a "real" IP address in the client host machines.
- ☉ **Compatibility Problems With Certain Applications:** I said above that NAT was only **mostly** transparent. There are in fact compatibility issues with certain applications that arise because NAT "tinkers" with the IP header fields in datagrams but not in the application data. This means tools like [FTP](#), which pass IP addresses and port numbers in commands, must be specially handled, and some applications may not work.

-
- **Problems With Security Protocols:** Protocols like [IPSec](#) are designed to detect modifications to headers and commonly balk at the changes that NAT makes, since they cannot differentiate those changes from malicious datagram “hacking”. It is still possible to combine NAT and IPSec, but this becomes more complicated.
 - **Poor Support for Client Access:** The lack of a public IP address for each client is a double-edged sword; it protects against hackers trying to access a host but also makes it difficult for legitimate access to clients on the local network. “Peer-to-peer” applications are harder to set up, and something like an organizational web site (accessed from the Internet as a whole) usually needs to be set up without NAT.
 - **Performance Reduction:** Each time a datagram transitions between the private network and the Internet, an address translation is required. In addition, other work must be done as well, such as recalculating header checksums. Each individual translation takes little effort but when you add it up, you are giving up some performance.

Many organizations feel that the advantages outweigh the disadvantages, especially if they do use the Internet in primarily a [client/server](#) fashion, as most do. For this reason NAT has become quite popular. One should always bear in mind, however, that the main problem that led to NAT is lack of address space. IPv6 fixes this problem, while NAT merely finds a clever “workaround” for it. For this reason, many people consider NAT a “kludge”. Once IPv6 is deployed, it will no longer be needed, and some folks don’t like it even for IPv4. On the other hand, some feel its other benefits make it worthy of consideration even in IPv6.



Note: A “kludge” (or “kluge”) is something that is used to address a problem in an inelegant way, like hammering a nail using the side of an adjustable wrench. (I would never do such a thing, of course not...)

IP NAT Address Terminology

As its name clearly indicates, IP Network Address Translation is all about the *translation* of IP addresses. When datagrams pass between the private network of an organization and the public Internet, one or more of the addresses in these datagrams are changed by the NAT router. This translation means that every transaction in a NAT environment involves not just a source address and a destination address, but potentially multiple addresses for each of the source and destination.

In order to make more clear the explanation of how NAT operates, several special designations have been developed to refer to the different types of addresses that can be found in an IP datagram when NAT is used. Unfortunately, the terminology used for addressing in NAT can be confusing, because it’s hard to visualize what the differences are between the (often similar-sounding) names. However, without knowing what these addresses mean a proper understanding of NAT operation is impossible, so we need to start by explaining them.

NAT Address Terms Based on Device Location (Inside/Outside)

The first way that addresses are differentiated is based on where in the network the device is that the address refers to:

- ☉ **Inside Address:** Any device on the organization's private network that is using NAT is said to be on the *inside network*. Thus, any address that refers to a device on the local network in any form is called an *inside* address.
- ☉ **Outside Address:** The public internet—that is, everything outside the local network—is considered the *outside network*. Any address that refers to a public Internet device is an *outside* address.



Key Concept: In NAT, the terms *inside* and *outside* are used to identify the **location** of devices. *Inside* addresses refer to devices on the organization's private network; *outside* addresses refer to devices on the public Internet.

NAT Address Terms Based on Datagram Location (Local/Global)

An inside device always has an inside address; an outside device always has an outside address. However, there are two different ways of addressing either an inside or an outside device, depending on in which part of the network the address appears in a datagram:

- ☉ **Local Address:** This term describes an address that appears in a datagram on the inside network, **whether it refers to an inside or outside address**.
- ☉ **Global Address:** This term describes an address that appears in a datagram on the outside network, again **whether it refers to an inside or outside address**.



Key Concept: In NAT, the terms *local* and *global* are used to indicate in what network a particular **address** appears. *Local* addresses are used on the organization's private network (whether to refer to an inside device or an outside device); *global* addresses are used on the public Internet (again, whether referring to an inside or outside device).

Combining Inside/Outside and Local/Global Address Designations

This is a bit confusing, so I will try to explain further. The NAT translating router has the job of interfacing the inside network to the outside network (the Internet). Inside devices need to be able to talk to outside devices and vice-versa, but inside devices can only use addressing consistent with the local network addressing scheme. Similarly, outside devices cannot use local addressing. Thus, both inside and outside devices can be referred to with local or global address versions. This yields four different specific address types:

-
1. **Inside Local Address:** An address of a device on the local network, expressed using its normal local device representation. So for example, if we had a client on a network using the 10.0.0.0 private address block, and assigned it address 10.0.0.207, this would be its *inside local* address.
 2. **Inside Global Address:** This is a global, publicly-routable IP address used to represent an inside device to the outside world. In a NAT configuration, *inside global* addresses are those “real” IP addresses assigned to an organization for use by the NAT router.

Let's say that device 10.0.0.207 wants to send an HTTP request to an Internet server located at address 204.51.16.12. It forms the datagram using 10.0.0.207 as the source address. However, if this datagram is sent out to the Internet as is, the server cannot reply back because 10.0.0.207 is not a publicly-routable IP address. So the NAT router will translate 10.0.0.207 in the datagram into one of the organization's registered IP addresses, say it's 194.54.21.10. This is the *inside global* address that corresponds to 10.0.0.207. It will be used as the destination when the server sends its HTTP response. Note that in some situations the inside local address and outside local address may be the same.

3. **Outside Global Address:** An address of an external (public Internet) device as it is referred to on the global Internet. This is basically a regular, publicly-registered address of a device on the Internet. In the example above, 204.51.16.12 is an *outside global* address of a public server.
4. **Outside Local Address:** An address of an external device as it is referred to by devices on the local network. In some situations, this may be identical to the *outside global* address of that outside device.

Local/Global Address Designations from the Perspective of Device Location

Phew, it's still confusing, isn't it? Let's try another way of looking at this. Of these four addresses, two types are the addresses as they are known “natively” by either an inside or outside device, while two are translated addresses:

- ☉ **Inside Device Designations:** For an inside device, the *inside local* address is its “normal” or “native” address. The *inside global* address is a translated address used to represent the inside device on the outside network, when necessary.
- ☉ **Outside Device Designations:** For an outside device, the *outside global* address is its “normal/native” address. The *outside local* address is a translated address used to represent the outside device on the inside network, when necessary.

So, what NAT does then is translate the identity of either inside or outside devices from local representations to global representations and vice-versa. Which addresses are changed, and how, depends on the specific type of NAT employed. For example, in traditional NAT, inside devices refer to outside devices using their proper (global) representation, so the outside global and outside local addresses of these outside devices are the same.



Key Concept: A NAT router translates *local* addresses to *global* ones, and vice-versa. Thus, an *inside local* address is translated to an *inside global* address (and vice-versa) and an *outside local* address is translated to an *outside global* address (and vice-versa).

Graphical Illustration of NAT Terminology

And after all that... it's still confusing. ☺ One of the big problems is that the words “inside” and “local” are somewhat synonymous, as are “outside” and “global”, yet they mean different things in NAT. And the typical paradox in trying to explain networking concepts rears its ugly head here again: I wanted to define these addresses to make describing NAT operation easier, but find myself wanting to use an example of NAT operation to clarify how the addresses are used.

Even after writing this section I find these terms confusing, so I created [Figure 111](#), which shows this same terminology in graphical form and may be of some help. That diagram is also used as a template for the illustrations of each of the different types of NAT in subsequent topics, which use the same color coding for each of the four address types for consistency. As you read the topics that discuss NAT operation, remember to look back here if you want to double-check the meaning of address types. Don't get discouraged if it takes a couple of times to get the addresses straight.

IP NAT Static and Dynamic Address Mappings

NAT allows us to connect a private (inside) network to a public (outside) network such as the Internet, by using an address translation algorithm implemented in a router that connects the two. Each time a NAT router encounters an IP datagram that crosses the boundary between the two networks it must translate addresses as appropriate. But how does it know what to translate, and what to use for the translated address?

The NAT software in the router must maintain a *translation table* to tell it how to operate. The translation table contains information that maps the *inside local* addresses of internal devices (their regular addresses) to *inside global* address representations (the special public addresses used for external communication). It may also contain mappings between *outside global* addresses and *outside local* addresses for inbound transactions, if appropriate.

There are two basic ways that entries can be added to the NAT translation table.

Static Mappings

When static mappings are used, a permanent, fixed relationship is defined between a *global* and a *local* representation of the address of either an *inside* or an *outside* device. For example, we can use a static translation if we want the internal device with an *inside local*

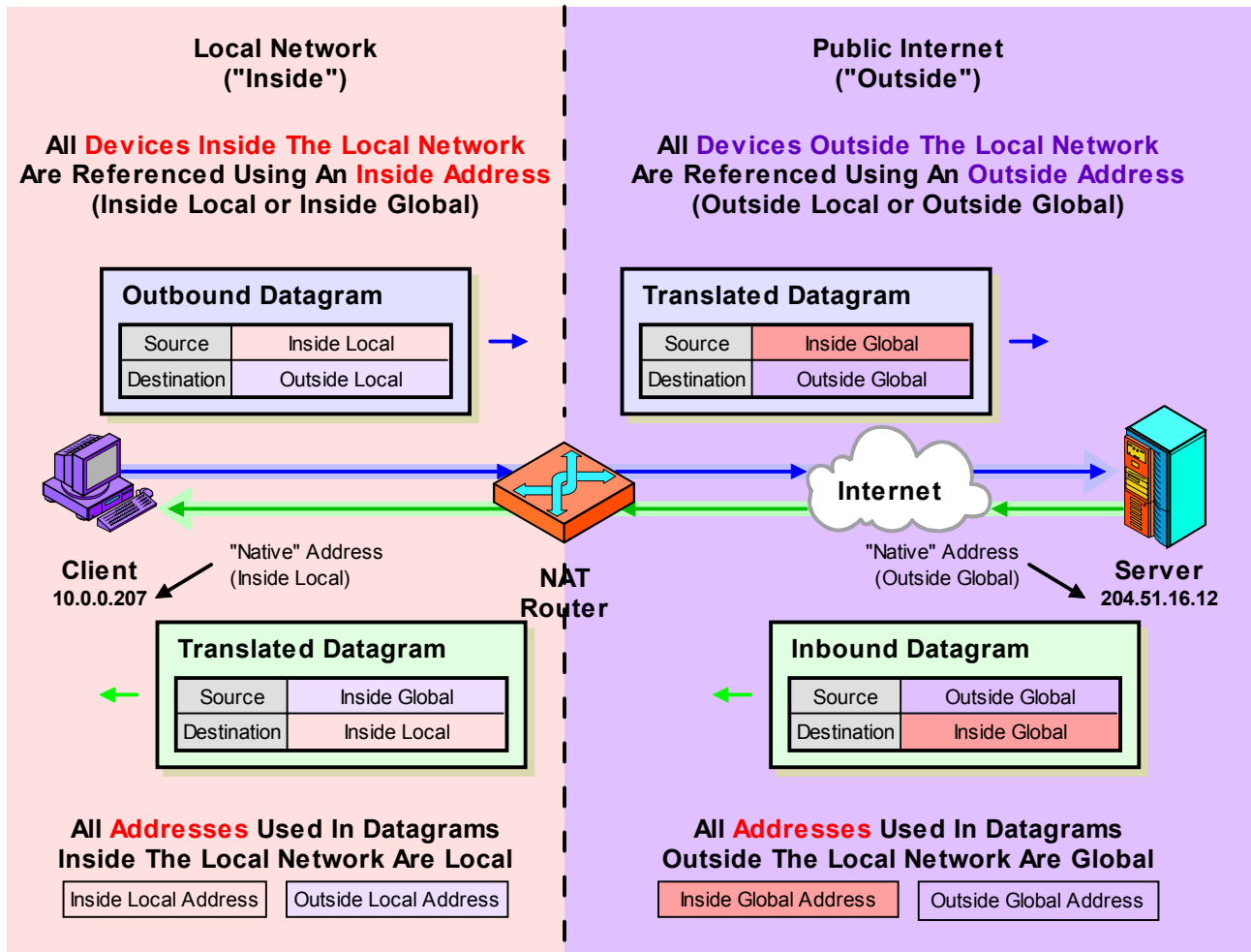

Figure 111: IP Network Address Translation (NAT) Terminology

Hopefully this diagram will help you better understand the whole "inside/outside/local/global" thing. ☺

address of 10.0.0.207 to **always** use the *inside global* address of 194.54.21.10. Whenever 10.0.0.207 initiates a transaction with the Internet, the NAT router will replace that address with 194.54.21.10.

Dynamic Mappings

With dynamic mappings, *global* and *local* address representations are generated automatically by the NAT router, used as needed, and then discarded. The most common way that this is employed is in allowing a *pool* of *inside global* addresses to be shared by a large number of *inside* devices.

For example, say we were using dynamic mapping with a pool of *inside global* addresses available from 194.54.21.1 through 194.54.21.20. When 10.0.0.207 sent a request to the Internet it would not automatically have its source address replaced by 194.54.21.10. One of the 20 addresses in the pool would be chosen by the NAT router. The router would then

watch for replies back using that address and translate them back to 10.0.0.207. When the session was completed, it would discard the entry to return the *inside global* address to the pool.

Comparing Static and Dynamic Mappings

The trade-offs between static and dynamic NAT mappings are pretty much the same as they always are when the choice is between “static” and “dynamic”; for example, the same issues arises in [ARP caching](#). Static mappings are permanent and therefore ideal for devices that need to be always represented with the same public address on the outside network. They may also be used to allow inbound traffic to a particular device; that is, for transactions initiated on the public network that send to a special server on the inside network. However, they require manual setup and maintenance, and they don't allow IP sharing on the internal network.

Dynamic mapping is normally used for regular clients in order to facilitate public IP address sharing, a prime goal of most NAT implementations. It is more complicated than static mapping, but once set up is automatic.

It is possible to mix dynamic and static mapping on the same system, of course. We can designate certain devices that are statically mapped and let the rest use dynamic mapping. We just have to make sure that the static mappings don't overlap with the pool used for dynamic assignment.

Incidentally, another way that dynamic mapping of global and local addressing is performed is through domain name resolution using [DNS](#). This is particularly common when external devices access internal hosts using bidirectional NAT (inbound transactions). Since hosts on the public Internet know nothing about the organization's private network, they issue a request for the DNS name of the device they want to access. This causes a NAT translation entry to be generated that maps the inside local public address of the host to an inside global address for use by those outside the network. [See the description of bidirectional NAT for more details on how this works.](#)

IP NAT Unidirectional (Traditional/Outbound) Operation

Now that we understand [the motivation behind NAT and its pros and cons](#), and have also [covered NAT address terminology](#) and [translation table creation](#), it's time to get down to the nitty gritty of how it works. There are many different flavors of NAT, and four common ones are covered in this Guide. It makes sense to start by looking at the original variety of NAT described in RFC 1631. This is the simplest NAT method and therefore the easiest one to explain.

NAT was of course designed to allow hosts on a private network to share public IP addresses in accessing an Internet. Since most hosts are clients that initiate transactions, NAT was designed under the assumption that a client/server request/response communication would begin with a datagram sent from the *inside* network to the *outside*. For this

reason, this first type of NAT is sometimes called *Unidirectional* or *Outbound* NAT. Since it is the oldest flavor it is also now called *Traditional* NAT, to differentiate it from newer varieties.

Unidirectional NAT Example

To show how unidirectional NAT works, we will of course use an example. Explaining things is always easier with examples, especially when it is a confusing thing like NAT. Let's use the same numbers from the previous two topics. We'll assume the inside network has 250 hosts that use private (inside local) addresses from the 10.0.0.0/8 address range (which I selected because it has small numbers!) These hosts use dynamic NAT sharing a pool of 20 inside global addresses from 194.54.21.1 through 194.54.21.20.

In our example, device 10.0.0.207 wants to access the World Wide Web server at public address 204.51.16.12. [Table 75](#) shows the four basic steps that are involved in this (simplified) transaction. I did this in table form instead of bullet points so I could show you explicitly what happens to the addresses in both the request datagram (in steps #1 and #2) and the response datagram (steps #3 and #4). I have also highlighted the translated address values for clarity, and provided [Figure 112](#), which shows the process graphically.

Table 75: Operation Of Unidirectional (Traditional/Outbound) NAT

Step #	Description	Data-gram Type	Datagram Source Address	Datagram Destination Address
1	Inside Client Generates Request And Sends To NAT Router: Device 10.0.0.207 generates an HTTP request that is eventually passed down to IP and encapsulated in an IP datagram. The source address is itself, 10.0.0.207, and the destination is 204.51.16.12. The datagram is sent to the NAT-capable router that connects the organization's internal network to the Internet.	Request (from inside client to outside server)	10.0.0.207 (<i>Inside Local</i>)	204.51.16.12 (<i>Outside Local</i>)
2	NAT Router Translates Source Address and Sends To Outside Server: The NAT router realizes that 10.0.0.207 is an <i>inside local</i> address and knows it must substitute an <i>inside global</i> address in order to let the public Internet destination respond. It consults its pool of addresses and sees the next available one is 194.54.21.11. It changes the source address in the datagram from 10.0.0.207 to 194.54.21.11. The destination address is not translated in traditional NAT. In other words, the <i>outside local</i> address and <i>outside global</i> address are the same. The NAT router puts the mapping from 10.0.0.207 to 194.54.21.11 into its translation table. It sends out the modified datagram, which is eventually routed to the server at 204.51.16.12.		194.54.21.11 (<i>Inside Global</i>)	204.51.16.12 (<i>Outside Global</i>)
3	Outside Server Generates Response And Sends Back To NAT Router: The server at 204.51.16.12 generates an HTTP response. It of course has no idea that NAT was involved; it sees 194.54.21.11 in the request sent to it, so that's where it sends back the response. It is then routed back to the original client's NAT router.	Response (from outside server to inside client)	204.51.16.12 (<i>Outside Global</i>)	194.54.21.11 (<i>Inside Global</i>)
4	NAT Router Translates Destination Address And Delivers Datagram To Inside Client: The NAT router sees 194.54.21.11 in the response that arrived from the Internet. It consults its translation table and knows this datagram is intended for 10.0.0.207. This time the destination address is changed but not the source. It then delivers the datagram back to the originating client.		204.51.16.12 (<i>Outside Local</i>)	10.0.0.207 (<i>Inside Local</i>)

As you can see, this really isn't rocket science, and it's fairly easy to understand what is going on as soon as you get used to the terminology and concepts. In unidirectional NAT the source address is translated on outgoing datagrams and the destination address on

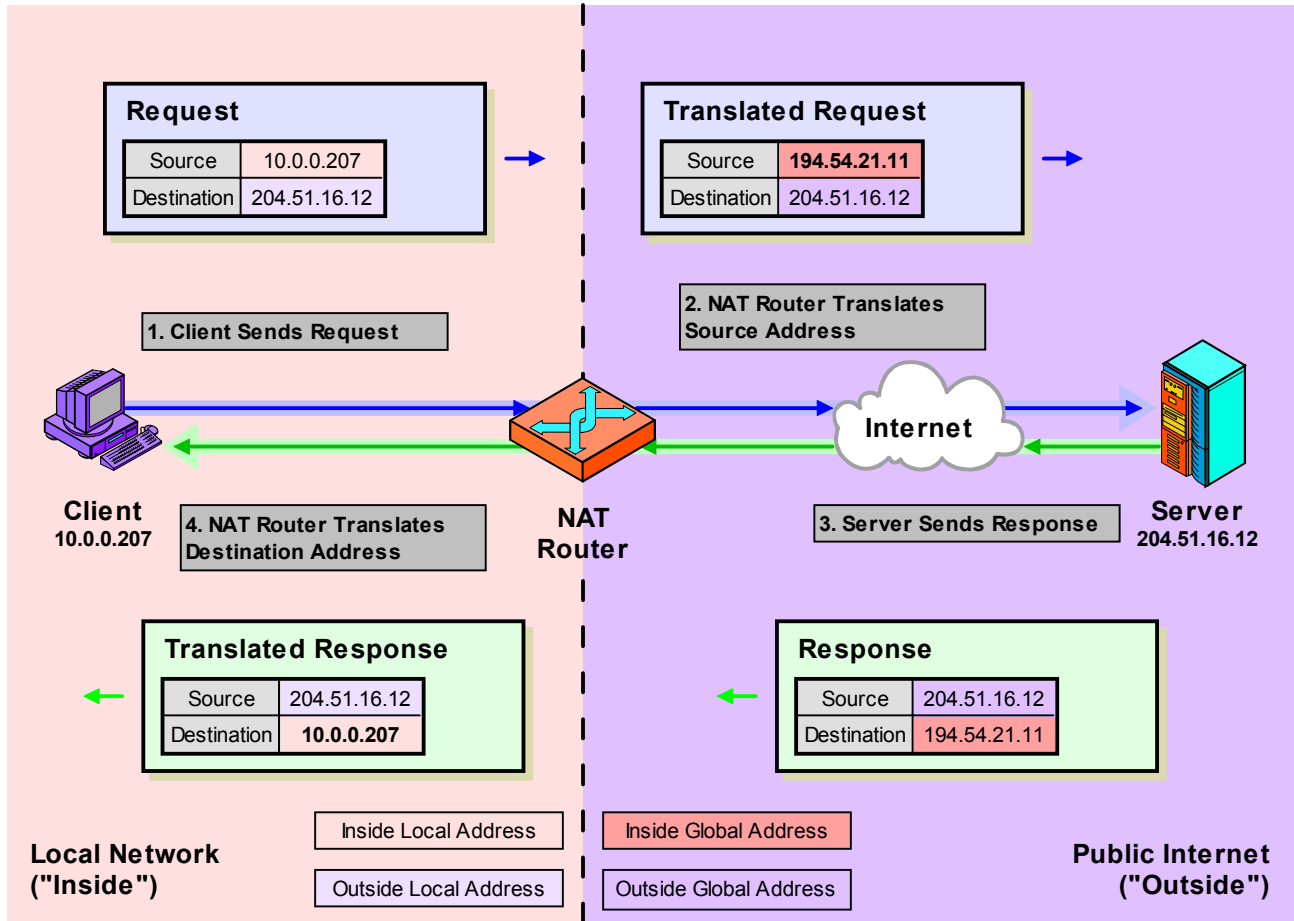

Figure 112: Operation Of Unidirectional (Traditional/Outbound) NAT

The four steps in this process can be seen by following the steps in clockwise order. Translated addresses are shown in bold. Please refer to [Table 75](#) for an explanation of the steps in this diagram, or to [Figure 111](#) for an explanation of the four address types.

incoming ones. Traditional NAT only supports this sort of *outbound* transaction, which is started by a device on the inside network. It cannot handle a device on the public Internet sending a request to a private address.

Other Functions of the Router in NAT

Also note that even though I am focusing on the changes that the NAT router makes to addresses, it also has to make other changes to the datagram. Changing any field in the IP header means that the IP *Header Checksum* field will need to be recalculated. UDP and TCP checksums need to be recalculated, and depending on the nature of the data in the datagram, other changes may also be required. [I discuss these issues in the topic on NAT compatibility issues.](#)

This simplified example assumes the existence of just one router between the private and public networks. It is possible to have more than one router between these networks. If this configuration is used, however, it is essential that they both use the same translation table. Otherwise, if the request is processed by router R1 but the response received by router R2,

R2 won't know how to translate back the destination address on the incoming datagram. Of course, this makes dynamic mapping extremely difficult: routers would have to coordinate their address mappings.



Key Concept: In *unidirectional (traditional)* NAT, the NAT router translates the source address of an outgoing request from *inside local* to *inside global* form. It then transforms the destination address of the response from *inside global* to *inside local*. The *outside local* and *outside global* addresses are the same in both request and reply.

IP NAT Bidirectional (Two-Way/Inbound) Operation

Traditional NAT is designed to handle only *outbound* transactions; clients on the local network initiate requests and devices on the Internet send back responses. However, in some circumstances, we may want to go in the opposite direction. That is, we may want to have a device on the outside network initiate a transaction with one on the inside. To permit this, we need a more capable type of NAT than the traditional version. This enhancement goes by various names, most commonly *Bidirectional NAT*, *Two-Way NAT* and *Inbound NAT*. All of these convey the concept that this kind of NAT allows both the type of transaction we saw in the previous topic and also transactions initiated from the outside network.

The Problem With Inbound NAT: Hidden Addresses

Performing NAT on inbound transactions is more difficult than conventional outbound NAT. To understand why, remember that the network configuration when using NAT is inherently **asymmetric**: the inside network generally knows the IP addresses of outside devices, since they are public, but the outside network doesn't know the private addresses of the inside network. Even if they did know them, they could never be specified as the target of an IP datagram initiated from outside since they are **not routable**—there would be no way to get them to the private network's local router.

Why does this matter? Well, consider the case of outbound NAT from device A on the inside network to device B on the outside. The local client, A, always starts the transaction, so device A's NAT router is able to create a mapping between device A's inside local and inside global address during the request. Device B is the recipient of the already-translated datagram, so the fact that device A is using NAT is hidden. Device B responds back and the NAT router does the reverse translation without device B ever even knowing NAT was used for device A.

Now, let's look at the inbound case. Here, device B is trying to send to device A, which is using NAT. Device B can't send to device A's private (inside local) address. It needs device A's inside global address in order to start the ball rolling. However, device A's NAT router isn't proximate to device B. In fact, device B probably doesn't even know the identity of device A's NAT router!

Facilitating Inbound NAT Using DNS

There are only two methods to resolve the hidden address problem. One is to use static mapping for devices like servers on the inside network that need to be accessed from the outside. When static mapping is employed, the global address of the device that is using the static mapping will be publicly known, which solves the “where do I send my request to” problem.

The other solution is to make use of the TCP/IP *Domain Name System (DNS)*. [As explained in detail in the section on DNS](#), this protocol allows requests to be sent as names instead of IP addresses; the DNS server translates these names to their corresponding addresses. It is possible to integrate DNS and NAT so they work together. This process is described in RFC 2694, [DNS extensions to Network Address Translators \(DNS_ALG\)](#).

In this technique, an outside device can in fact make use of dynamic mapping. The basic process (highly simplified) is as follows:

1. The outside device sends a DNS request using the name of the device on the inside network it wishes to reach. For example, it might be “www.ilikenat.com”.
2. The DNS server for the internal network **resolves** the “www.ilikenat.com” name into an *inside local* address for the device that corresponds to this DNS entry.
3. The *inside local* address is passed to NAT and used to create a dynamic mapping between the *inside local* address of the server being accessed from the outside, and an *inside global* address. This mapping is put into the NAT router's translation table.
4. When the DNS server sends back the name resolution, it tells the outside device not the *inside local* (private) address of the server being sought, but the *inside global* (public) address mapped in the previous step.

Bidirectional NAT Example

Once the inside global address of the device on the inside network is known by the outside device, the transaction can begin. Let's use the same example as in the previous topic, only we reverse it, so that outside device 204.51.16.12 is initiating a request (and is thus now the **client**) to inside device 10.0.0.207 (which is the **server**). Let's say that either static mapping

or DNS has been used so that the outside device knows the inside global address of 10.0.0.207 is actually 194.54.21.6. [Table 76](#) describes the transaction in detail; it is illustrated in [Figure 113](#) as well.

Table 76: Operation Of Bidirectional (Two-Way/Inbound) NAT

Step #	Description	Data-gram Type	Datagram Source Address	Datagram Destination Address
1	Outside Client Generates Request And Sends To NAT Router: Device 204.51.16.12 generates a request to the inside server. It uses the <i>inside global</i> address 194.54.21.6 as the destination. The datagram will be routed to the local router for that address, which is the NAT router that services the inside network where the server is located.	Request (from outside client to inside server)	204.51.16.12 (<i>Outside Global</i>)	194.54.21.6 (<i>Inside Global</i>)
2	NAT Router Translates Destination Address and Sends To Inside Server: The NAT router already has a mapping from the <i>inside global</i> address to the <i>inside local</i> address of the server. It replaces the 194.54.21.6 destination address with 10.0.0.207, and performs checksum recalculations and other work as necessary. The source address is not translated. The router then delivers the modified datagram to the inside server at 10.0.0.207.		204.51.16.12 (<i>Outside Local</i>)	10.0.0.207 (<i>Inside Local</i>)
3	Inside Server Generates Response And Sends Back To NAT Router: The server at 10.0.0.207 generates a response, which it addresses to 204.51.16.12 since that was the source of the request to it. This is then routed to the server's NAT router.	Response (from inside server to outside client)	10.0.0.207 (<i>Inside Local</i>)	204.51.16.12 (<i>Outside Local</i>)
4	NAT Router Translates Source Address And Routes Datagram To Outside Client: The NAT router sees the private address 10.0.0.207 in the response and replaces it with 194.54.21.6. It then routes this back to the original client on the outside network.		194.54.21.6 (<i>Inside Global</i>)	204.51.16.12 (<i>Outside Global</i>)

As you can see, once the outside device knows the inside device's *inside global* address, inbound NAT is very similar to outbound NAT. It just does the exact opposite translation. Instead of modifying the source address on the outbound request and the destination on the inbound response, the router changes the destination on the inbound request and the source on the outbound reply.

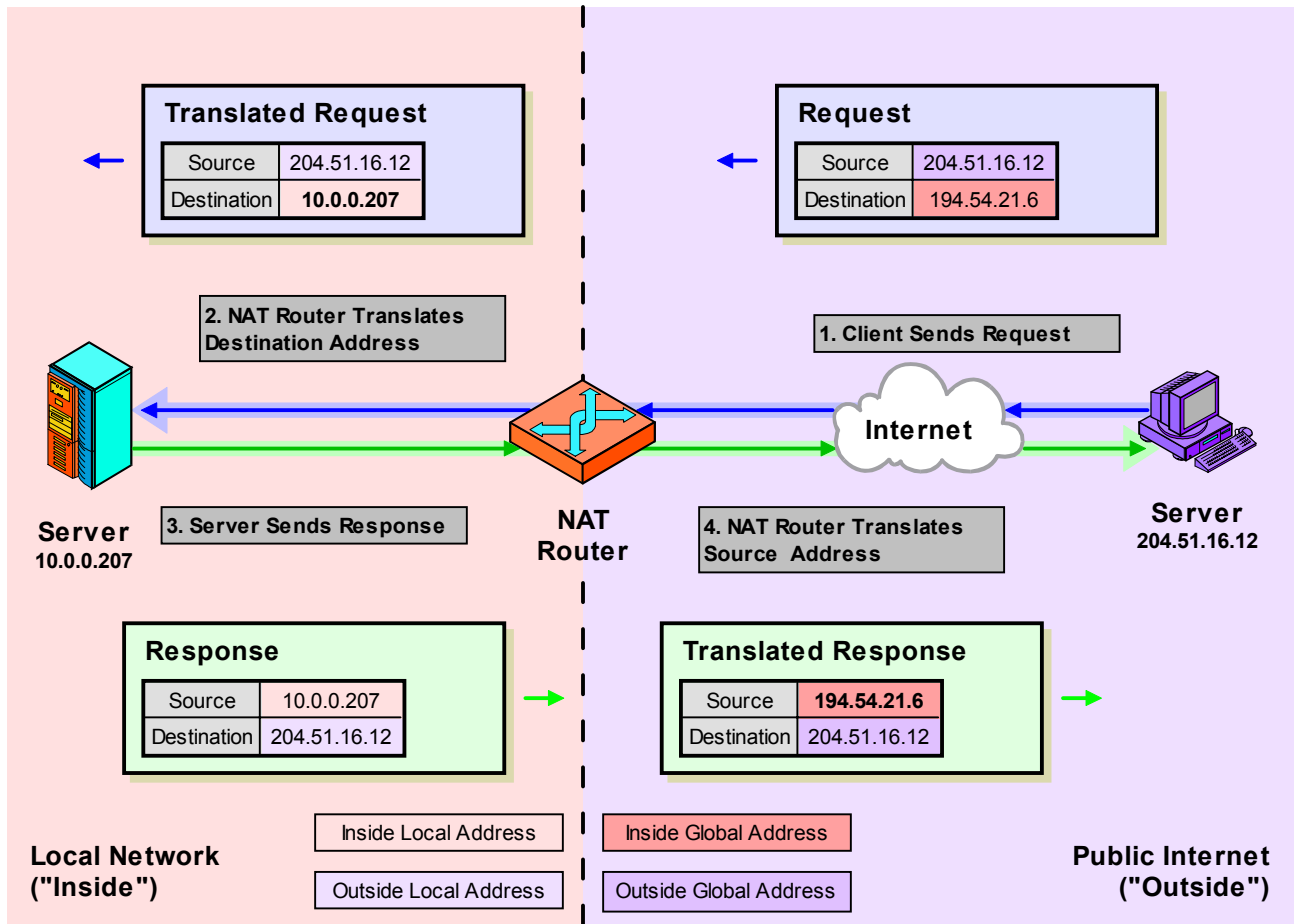

Figure 113: Operation Of Bidirectional (Two-Way/Inbound) NAT

This figure is very similar to [Figure 112](#), except that the transaction is in reverse, so please start at the upper right and go counter-clockwise. Translated addresses are shown in bold. [Table 76](#) contains a complete explanation of the four steps. Refer to [Figure 111](#) for an explanation of address types.



Key Concept: In traditional NAT, a transaction must begin with a request from a client on the local network, but in *bidirectional (two-way/inbound)* NAT, it is possible for a device on the public Internet to access a local network server. This requires the use of either static mapping or DNS to provide to the outside client the address of the server on the inside network. Then the NAT transaction is pretty much the same as in the unidirectional case, except in reverse: the incoming request has its destination address changed from *inside global* to *inside local*; the response has its source changed from *inside local* to *inside global*.

IP NAT Port-Based ("Overloaded") Operation: Network Address Port Translation (NAPT) / Port Address Translation (PAT)

Both [traditional NAT](#) and [bidirectional NAT](#) work by swapping inside network and outside network addresses as needed to allow a private network to access a public one. For each transaction, there is a one-to-one mapping between the *inside local* address of a device on the private network, and the *inside global* address that represents it on the public network. We can use [dynamic address assignment](#) to allow a large number of private hosts to share a small number of registered public addresses.

However, there is a potential snag here. Consider our earlier NAT example, where 250 hosts share 20 inside global (public) addresses. If 20 hosts already have transactions in progress, what happens when the 21st tries to access the Internet? There aren't any *inside global* addresses available for it to use, so it won't be able to.

Using Ports to Multiplex Private Addresses

Fortunately, there is a mechanism already built into TCP/IP that can help us alleviate this situation. [The two TCP/IP transport layer protocols, TCP and UDP](#), both make use of additional addressing components called *ports*. The port number in a TCP or UDP message helps identify individual connections between two addresses. It is used to allow many different applications on a TCP/IP client and server to talk to each simultaneously, without interference. For example, you use this capability when you open multiple browser windows to access more than one Web page on the same site at the same time. This [sharing of IP addresses amongst many connections](#) is called *multiplexing*. [The section on TCP and UDP ports describes all of this in much more detail.](#)

Now, let's come back to NAT. We are already translating IP addresses as we send datagrams between the public and private portions of the internetwork. What if we could also translate port numbers? Well, we can! The combination of an address and port uniquely identifies a connection. As a datagram passes from the private network to the public one, we can change not just the IP address but also the port number in the TCP or UDP header. The datagram will be sent out with a different source address and port. The response will come back to this same address and port combination (called a *socket*) and can be translated back again.

This method goes by various names. Since it is a technique whereby we can have multiple inside local addresses share a single inside global address, it is called *overloading* of an *inside global* address, or alternately, just *overloaded NAT*. More elegant names that better indicate how the technique works include *Port-Based NAT*, *Network Address Port Translation (NAPT)* and *Port Address Translation (PAT)*.

Whatever its name, the use of ports in translation has tremendous advantages. It can allow all 250 hosts on our private network to use only 20 IP addresses—and potentially even fewer than that. In theory you could even have all 250 share a single public IP address at once! You don't want to share so many local hosts that you run out of port numbers, but there are thousands of port numbers to choose from.

Port-based NAT of course requires a router that is programmed to make the appropriate address and port mappings for datagrams as it transfers them between networks. The disadvantages of the method include this greater complexity, and also more potential compatibility issues (such as with applications like FTP) since we must now watch for port numbers at higher layers and not just IP addresses.



Key Concept: *Port-based* or “*overloaded*” NAT is an enhancement of regular NAT that allows a large number of devices on a private network to simultaneously “share” a single inside global address by changing the port numbers used in TCP and UDP messages.

Port-Based NAT Example

The operation of NAT/PAT is very similar to the way regular NAT works, except that port numbers are also translated. For a traditional outbound transaction, the source port number is changed on the request at the same time that the source address is modified; the destination port number is modified on the response with the destination address.

Let's consider again [the example we looked at in the topic on Traditional NAT](#), but this time in a PAT environment. Device 10.0.0.207 was one of 250 hosts on a private network accessing the WWW server at 204.51.16.12. Let's say that because PAT is being used, to save money all 250 are sharing a single *inside global* address, 194.54.21.7, instead of a pool of 20. The transaction would proceed as described in [Table 77](#) and diagrammed in [Figure 114](#).

Table 77: Operation Of Port-Based (“Overloaded”) NAT

Step #	Description	Data-gram Type	Datagram Source Address:Port	Datagram Destination Address:Port
1	Inside Client Generates Request And Sends To NAT Router: Device 10.0.0.207 generates an HTTP request to the server at 204.51.16.12. The standard server port for WWW is 80, so the destination port of the request is 80; let's say the source port on the client is 7000. The datagram is sent to the NAT-capable router that connects the organization's internal network to the Internet.	<i>Request</i> (from inside client to outside server)	10.0.0.207:7000 (<i>Inside Local</i>)	204.51.16.12:80 (<i>Outside Local</i>)
2	NAT Router Translates Source Address And Port And Sends To Outside Server: The NAT router realizes that 10.0.0.207 is an <i>inside local</i> address and knows it must substitute an <i>inside global</i> address. Here though, there are multiple hosts sharing the single <i>inside global</i> address 194.54.21.7. Lets say that port 7000 is already in use for that address by another private host connection. The router substitutes the <i>inside global</i> address and also chooses a new source port number, say 7224, for this request. The destination address and port are not changed. The NAT router puts the address and port mapping into its translation table. It sends the modified datagram out, which arrives at the server at 204.51.16.12.		194.54.21.7:7224 (<i>Inside Global</i>)	204.51.16.12 (<i>Outside Global</i>)
3	Outside Server Generates Response And Sends Back To NAT Router: The server at 204.51.16.12 generates an HTTP response. It of course has no idea that NAT was involved; it sees an address of 194.54.21.7 and port of 7224 in the request sent to it, so it sends back to that address and port.	<i>Response</i> (from outside server to inside client)	204.51.16.12:80 (<i>Outside Global</i>)	194.54.21.7:7224 (<i>Inside Global</i>)
4	NAT Router Translates Destination Address And Port And Delivers Datagram To Inside Client: The NAT router sees the address 94.54.21.7 and port 7224 in the response that arrived from the Internet. It consults its translation table and knows this datagram is intended for 10.0.0.207, port 7000. This time the destination address and port are changed but not the source. The router then delivers the datagram back to the originating client.		204.51.16.12:80 (<i>Outside Local</i>)	10.0.0.207:7000 (<i>Inside Local</i>)

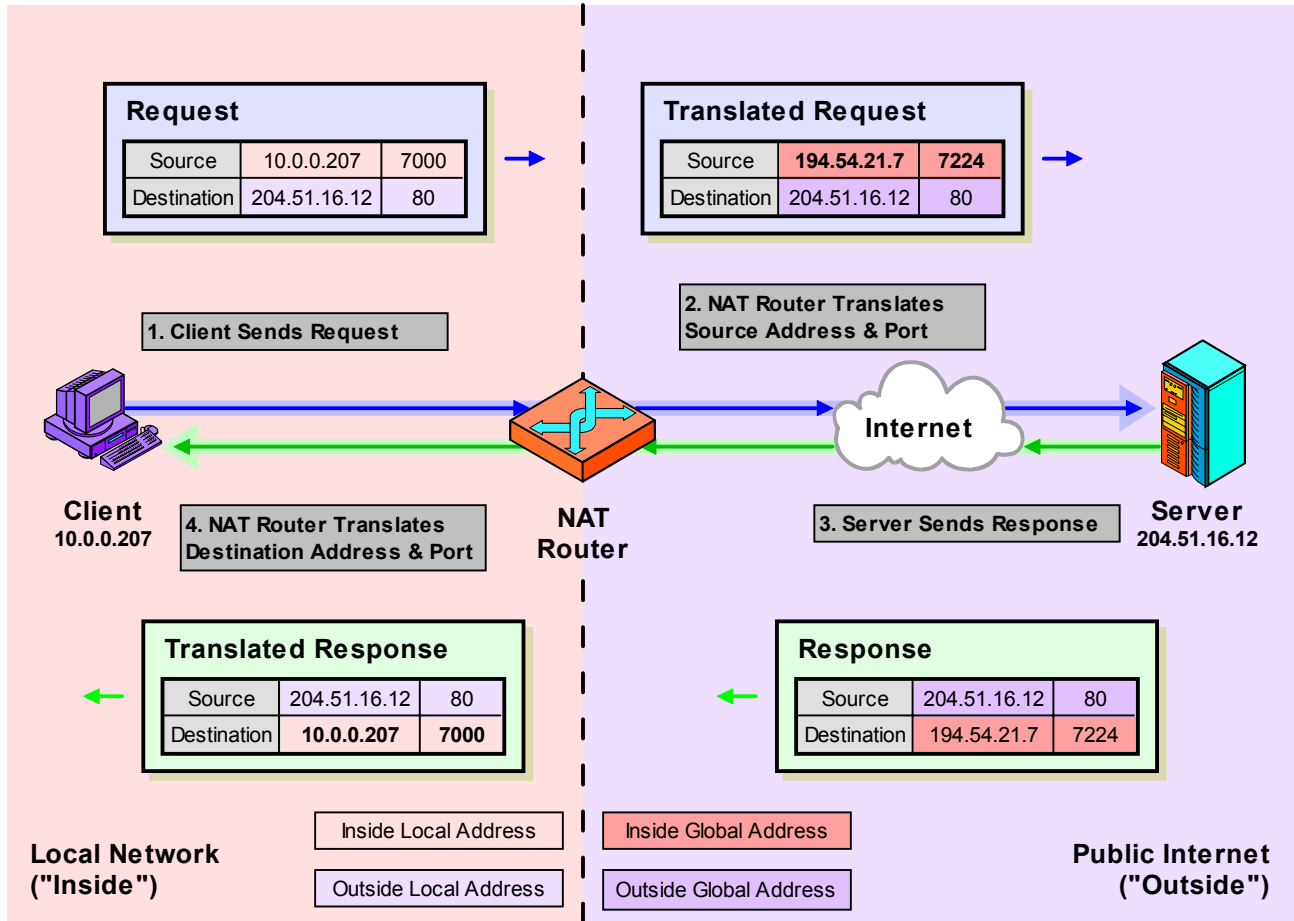

Figure 114: Operation Of Port-Based (“Overloaded”) NAT

This figure is very similar to [Figure 112](#), except that the source and destination port numbers have been shown, since they are used in this type of NAT. Translated addresses/ports are in bold. [Table 77](#) contains a complete explanation of the four steps in port-based NAT. Refer to [Figure 111](#) for an explanation of address types.



Key Concept: In port-based NAT, the NAT router translates the source address and port of an outgoing request from *inside local* to *inside global* form. It then transforms the destination address and port of the response from *inside global* to *inside local*. The *outside local* and *outside global* addresses are the same in both request and reply.

One other issue related to NAT/PAT is worth mentioning: it assumes that all traffic uses either UDP or TCP at the transport layer. While generally the case, this may not always be true. If there is no port number, port translation cannot be done and the method will not work.

IP NAT "Overlapping" / "Twice NAT" Operation

All three of the versions of NAT discussed so far—[traditional](#), [bidirectional](#) and [port-based](#)—are normally used to connect a network using private, non-routable addresses to the public Internet, which uses unique, registered, routable addresses. With these kinds of NAT, there will normally be no overlap between the address spaces of the inside and outside network, since the former are private and the latter public. This enables the NAT router to be able to immediately distinguish inside addresses from outside addresses just by looking at them.

In the examples we've seen so far, the inside addresses were all from the [RFC 1918 block](#) 10.0.0.0. These can't be public Internet addresses so the NAT router knew any address referenced by a request from the inside network within this range was a local reference within the inside network. Similarly, any addresses outside this range are easy to identify as belonging to the "outside world".

Cases With Overlapping Private and Public Address Blocks

There are circumstances however where there may indeed be an overlap between the addresses used for the inside network, and the addresses used for part of the outside network. Consider the following cases:

- ① **Private Network To Private Network Connections:** Our example network using 10.0.0.0 block addresses might want to connect to another network using the same method. This situation might occur if two corporations merge and happened to be using the same addressing scheme (and there aren't that many private IP blocks, so this isn't that uncommon).
- ② **Invalid Assignment of Public Address Space To Private Network:** Some networks might have been set up not using a designated private address block but rather a block containing valid Internet addresses. For example, suppose an administrator decided that the network he was setting up "would never be connected to the Internet" (ha!) and numbered the whole thing using 18.0.0.0 addresses, which belong to the Massachusetts Institute of Technology (MIT). Then later, this administrator's short-sightedness would backfire when the network did indeed need to be connected to the 'net.
- ③ **"Stale" Public Address Assignment:** Company A might have been using a particular address block for years that was reassigned or reallocated for whatever reason to company B. Company A might not want to go through the hassle of renumbering their network, and would then keep their addresses even while Company B started using them on the Internet.

What these situations all have in common is that the inside addresses used in the private network **overlap** with addresses on the public network. When a datagram is sent from within the local network, the NAT router can't tell if the intended destination is within the inside network or the outside network. For example, if we want to connect host 10.0.0.207 in our private network to host 10.0.0.199 in a different network, and we put 10.0.0.199 in the destination of the datagram and send it, how does the router know if we mean 10.0.0.199 on our own local network or the remote one? For that matter, we might need to send a

request to 10.0.0.207 in the other private network, our own address! Take the network that was numbered with MIT's address block. How does the router know when a datagram is actually being sent to MIT as opposed to another device on the private network?

Dealing With Overlapping Blocks By Using NAT Twice

The solution to this dilemma is to use a more sophisticated form of NAT. The other versions we have seen so far always translate either the source address **or** the destination address as a datagram passes from the inside network to the outside network or vice versa. To cope with overlapping addresses, we must translate both the source address **and** the destination address on each transition from the inside to the outside or the other direction. This technique is called *Overlapping NAT* in reference to the problem it solves, or *“Twice NAT”* due to how it solves it. (Incidentally, despite the latter name, regular NAT is *not* called “Once NAT”.)

Twice NAT functions by creating a set of mappings not only for the private network the NAT router serves, but also for the overlapping network (or networks) that conflict with the inside network's address space. In order for this to function, Twice NAT relies on the use of the [TCP/IP Domain Name System \(DNS\)](#), just like bidirectional NAT. This lets the inside network send requests to the overlapping network in a way that can be uniquely identified. Otherwise, the router can't tell what overlapping network our inside network is trying to contact.

“Overlapping” / “Twice” NAT Example

Let's try a new example. Suppose our network has been improperly numbered so that it is not in the 10.0.0.0 private block but in the 18.0.0.0 block used by MIT. A client on our private network, 18.0.0.18, wants to send a request to the server “www.twicenat.mit.edu”, which has the address 18.1.2.3 at MIT. Our client can't just make a datagram with 18.1.2.3 as the destination and send out, as the router will think it's on the local network and not route it. Instead, 18.0.0.18 uses a combination of DNS and NAT to get the outside device address as follows:

1. The client on our local network (18.0.0.18) sends a DNS request to get the address of “www.twicenat.mit.edu”.
2. The (Twice-NAT compatible) NAT router serving our local network intercepts this DNS request. It then consults its tables to find a special mapping for this outside device. Let's say, it is programmed to translate “www.twicenat.mit.edu” into the address 172.16.44.55. This is a private non-routable RFC 1918 address.
3. The NAT router returns this value, 172.16.44.55 to the source client, which uses it for the destination.

Once our client has the translated address, it initiates a transaction just as before. NAT now will perform both translation of the inside devices and the outside devices as well. The outside device address must be translated because the inside device is using 172.16.44.55, which isn't a valid address for the server it is trying to reach. The inside

device address must still be translated as in regular NAT because 18.0.0.18 is not a valid public address for us. It may refer to a real machine in MIT and we aren't supposed to be using it on the Internet!

Let's say that we are still using the pool of 20 inside global addresses from 194.54.21.1 through 194.54.21.20 for inside addresses, and let's further suppose the NAT router chooses 194.54.21.12 for this particular exchange. The transaction sequence would be roughly as described in [Table 78](#), and illustrated in [Figure 115](#).

Table 78: Operation Of “Overlapping” NAT / “Twice NAT”

Step #	Description	Data-gram Type	Datagram Source Address	Datagram Destination Address
1	Inside Client Generates Request And Sends To NAT Router: Device 18.0.0.18 generates a request using the destination 172.16.44.55 that it got from the (NAT-intercepted) DNS query for “www.twicenat.mit.edu. The datagram is sent to the NAT router for the local network.	Request (from inside client to outside server)	18.0.0.18 (<i>Inside Local</i>)	172.16.44.55 (<i>Outside Local</i>)
2	NAT Router Translates Source Address And Destination Address and Sends To Outside Server: The NAT router makes two translations. First, it substitutes the 18.0.0.18 address with a publicly registered address, which is 194.54.21.12 for this example. It then translates the bogus 172.16.44.55 back to the real MIT address for “www.twicenat.mit.edu”. It routes the datagram to the outside server.		194.54.21.12 (<i>Inside Global</i>)	18.1.2.3 (<i>Outside Global</i>)
3	Outside Server Generates Response And Sends Back To NAT Router: The MIT server at 18.1.2.3 generates a response and sends it back to 194.54.21.12, which causes it to arrive back at the NAT router.	Response (from outside server to inside client)	18.1.2.3 (<i>Outside Global</i>)	194.54.21.12 (<i>Inside Global</i>)
4	NAT Router Translates Source Address And Destination Address And Delivers Datagram To Inside Client: The NAT router translates back the destination address to the actual address being used for our inside client, as in regular NAT. It also substitutes back in the 172.16.44.55 value it is using as a substitute for the real address of “www.twicenat.mit.edu”.		172.16.44.55 (<i>Outside Local</i>)	18.0.0.18 (<i>Inside Local</i>)

As you can see, in this example the *outside local* and *outside global* addresses are different, unlike in the preceding NAT examples. Twice NAT can also handle an inbound transaction, by watching for datagrams coming in from the Internet that overlap with the addresses used on the local network and doing double substitutions as required.

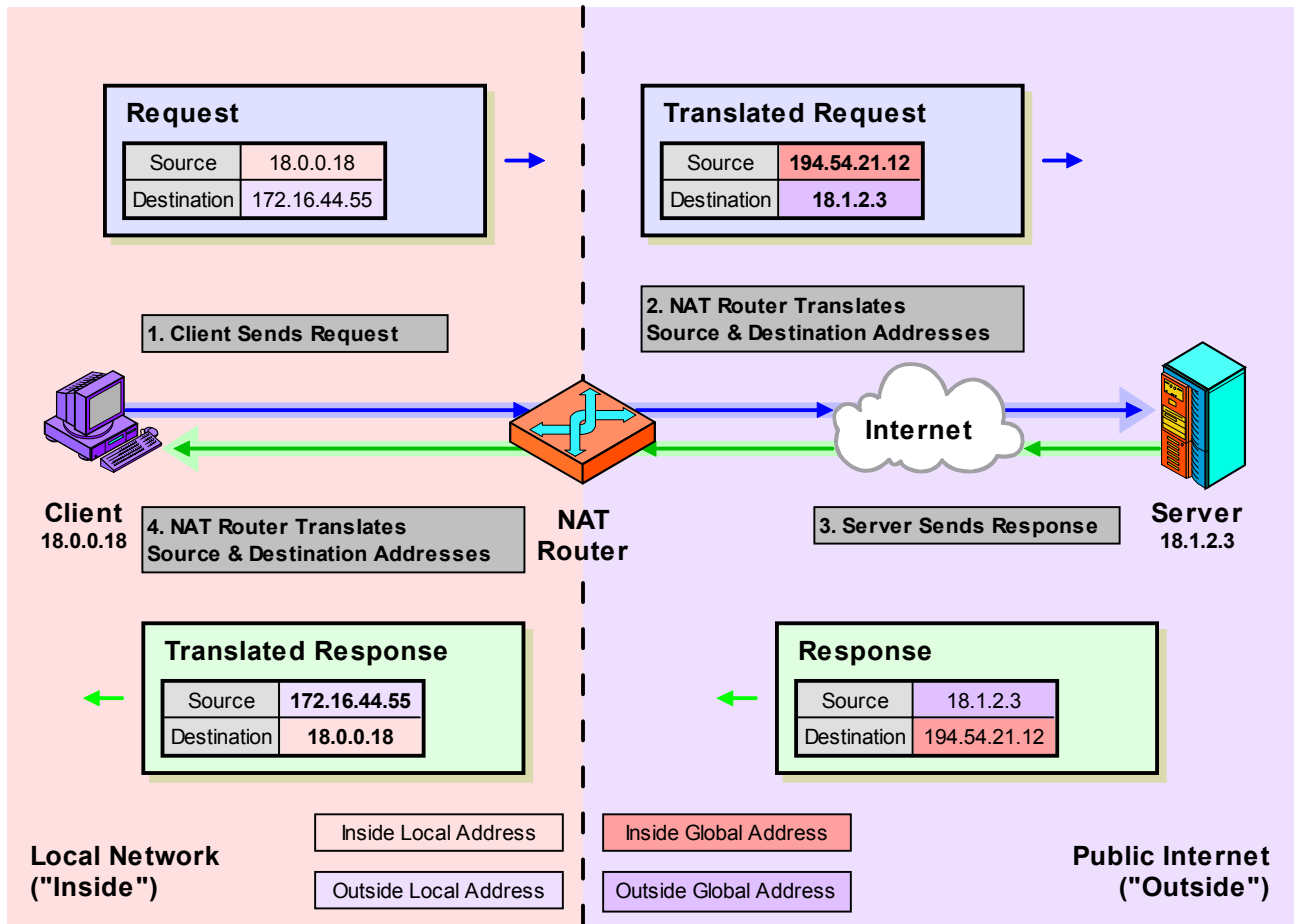

Figure 115: Operation Of “Overlapping” NAT / “Twice NAT”

This figure is very similar to [Figure 112](#), except that the as you can see, both source and destination addresses are translated by the NAT router each time (shown in bold). [Table 78](#) contains a complete explanation of the four steps in “overlapping” NAT. Refer to [Figure 111](#) for an explanation of address types.



Key Concept: “*Overlapping*” NAT is used in situations where both the source and destination addresses in a datagram are private addresses or otherwise cannot be used regularly on the public Internet. In this case, unlike the other types of NAT, the NAT router translates both the source and destination addresses of incoming and outgoing datagrams. On outgoing messages, *inside local* addresses are changed to *inside global* and *outside local* to *outside global*; on incoming messages, *inside global* addresses are changed to *inside local* and *outside global* to *outside local*.

IP NAT Compatibility Issues and Special Handling Requirements

In a perfect world, Network Address Translation could be made transparent to the devices using it. We'd like to be able to have a NAT router change IP addresses in request datagrams as they leave the network and change them back in responses that come back and have none of the hosts be any the wiser. Unfortunately, this ain't a perfect world.

It is not possible for NAT to be completely transparent to the devices that use it. There are potential compatibility problems that arise if NAT doesn't perform certain functions that go beyond simply swapping IP addresses and possibly port numbers in the IP header. The main problem is that even though IP addresses are supposedly the domain of the Internet Protocol, they are really used by other protocols as well, both at the network layer and in higher layers. When NAT changes the IP address in an IP datagram, it must often also change addresses in other places to make sure that the addresses in various headers and payloads still match.

These compatibility issues require that even though NAT should theoretically work only at the level of IP at the network layer, in practical terms NAT routers must be “aware” of many more protocols and perform special operations as required. Some are required for all datagrams that are translated, while others only apply to certain datagrams and not others. And even when these techniques are added to NAT routers, some things still may not work properly in a NAT environment.

Most NAT implementations do take these concerns into account. Certainly common applications like FTP are widely supported by NAT routers, or nobody would want to use NAT. That said, there may be some applications that will not work over NAT. The fact that NAT really isn't transparent and must do these extra sorts of “hacks” to other protocol headers and even payloads is a big part of the reason why many people refer to NAT as a “kludge”; elegant solutions don't have so many special cases that need special handling.

Let's take a look at some of the specific issues and requirements.

TCP and UDP Checksum Recalculations

Changing the IP addresses in the IP header means the [IP header checksum](#) must be calculated. Since both UDP or TCP also have checksums, and these checksums are computed over a [pseudo header that contains the IP source and destination address](#) as well, they too must be recalculated each time a translation is made.

ICMP Manipulations

Since NAT works so intimately with IP headers, and since IP is closely related to its “assistant” protocol [ICMP](#), NAT must also look for certain ICMP messages and make changes to addresses contained within them. Many ICMP messages, such as *Destination Unreachable* and *Parameter Problem* contain as data the original IP header of the datagram that led to the ICMP message. Since NAT is translating addresses in IP headers it must watch for these messages and translate addresses in included headers as required.

Applications That Embed IP Addresses

A number of TCP/IP applications embed IP addresses within the actual application data payload. The most notorious example of this is the [TCP/IP File Transfer Protocol \(FTP\)](#), which actually sends address and port assignments as text information in datagrams between devices during a connection. In order for NAT to support FTP, it must be specifically programmed with algorithms to look for this information and make changes as needed.

The level of complication can go even beyond this. Consider what happens when an FTP message containing these text address or port numbers is *fragmented*—part of the address to be translated may be in two different IP datagrams, and hard to recognize!

Additional Issues With Port Translation

When [port-based NAT \(PAT\)](#) is used, the issues that apply to addresses now apply to ports as well, making even more work for the router to perform.

Cascading Impact Of Changes To Address Or Port Numbers

Take the example of an FTP datagram encoding an IP address that NAT must change. The address being substituted might require more characters than the original; in our first example, 10.0.0.207 (10 ASCII characters) is replaced by 194.54.21.11 (12 ASCII characters). Making this substitution changes the size of the payload! This means that [TCP sequence numbers](#) also must be modified.

In these situations, NAT itself is supposed to take care of any additional work that may be required. This is definitely a complication that does not occur without the use of NAT, and is an often-cited example of NAT's "kludginess".

Problems With IPSec

When [IPSec](#) is used in [transport mode](#), both the [Authentication Header \(AH\)](#) and [Encapsulating Security Payload \(ESP\)](#) protocols use an integrity check that is based on the value of the entire payload. When NAT tries to update the TCP or UDP checksum in the IP datagram, this changes the value of data that the receiving device uses in performing the AH or ESP integrity check. The check will fail. Thus, NAT can't be used in IPSec transport mode. It may still work in [tunnel mode](#) but there can be complications here as well.



IP Security (IPSec) Protocols

One of the weaknesses of the original Internet Protocol is that it lacks any sort of general purpose mechanism for ensuring the authenticity and privacy of data as it is passed over the internetwork. Since IP datagrams must usually be routed between two devices over unknown networks, any information in them is subject to being intercepted and even possibly changed. With the increased use of the Internet for critical applications, security enhancements were needed for IP. To this end, a set of protocols called *IP Security* or *IPSec* was developed.

In this section I provide a brief description of IPSec concepts and protocols. I begin with an overview of IPSec, including a discussion of the history of the technology and defining standards. I describe the main components and protocols of the IPSec suite, and its different architectures and methods for implementation. I then move to actually discussing how IPSec works, beginning with a description of the two IPSec modes (transport and tunnel) and how they differ. I describe security associations and related constructs such as the Security Parameter Index (SPI). The last three topics cover the three main IPSec protocols: IPSec Authentication Header (AH), IPSec Encapsulating Security Payload (ESP) and the IPSec Internet Key Exchange (IKE).



Note: IPSec was initially developed with IPv6 in mind, but has been engineered to provide security for both IPv4 and IPv6 networks, and operation in both versions is similar. There are some differences in the datagram formats used for AH and ESP depending on whether IPSec is used in IPv4 and IPv6, since the two versions have different datagram formats and addressing. I highlight these differences where appropriate.



Note: There are many subjects in this Guide that are so involved that many large books have been written about them. Security on IP networks and IPSec is definitely in this category. Due to the already large size of this Guide and the complexity of IPSec, I can only provide here a very limited description of how it works. For more comprehensive information you will need to supplement with a reference specific to this technology.

IPSec Overview, History and Standards

The best-known problem with [the original Internet Protocol \(IPv4\)](#) is the pending exhaustion of its address space. This situation arose due to the rapid expansion of the Internet beyond anyone's expectations when IPv4 was developed. This same mismatch between how the Internet was when IPv4 was created and how it is now has led to another major problem with IP: the lack of a definitive means of ensuring security on IP internetworks.

The security problem arose because 25 years ago, the Internet was tiny and relatively “private”. Today it is enormous and truly “public”. As the Internet has grown, the need for security has grown with it. Consider that [TCP/IP and the early Internet precursors](#) were developed as very small networks used by government researchers at the United States Defense Advanced Research Projects Agency (*DARPA* or *ARPA*). All the hardware was controlled by people who were well known and would generally have had security clearance. In such a network, you don’t need to build security in to the protocols—you build it into the building! It’s easier to use locks and guards to ensure security than fancy encryption, when you can get away with it. After all, the easiest way to keep someone from snooping or tampering with data on the network is simply to deny them access to the hosts that connect to the network.

This worked fine at first when there were only a few dozen machines on the Internet. And even when the Internet first started to grow, it was used pretty much only to connect together researchers and other networking professionals. New sites were added to the network slowly at first, and at least someone knew the identity of each new site added to the growing internetwork. However, as the Internet continued to increase in size and eventually was opened to the public, maintaining security of the network as a whole became impossible. Today, the “great unwashed masses” are on the Internet. Many routers—owned by “who knows” and administered by “who knows”—stand between you and most other devices you want to connect with. You cannot assume that the data you send or receive is secure.

A number of methods have evolved over the years to address the need for security. Most of these are focused at [the higher layers of the OSI protocol stack](#), to compensate for IP’s lack of security. These solutions are valuable for certain situations, but they can’t be generalized easily because they are particular to various applications. For example, we can use [Secure Sockets Layer \(SSL\)](#) for certain applications like World Wide Web access or FTP, but there are dozens of applications that this type of security was never intended to work with.

What was really needed was a solution to allow security at the IP level so all higher-layer protocols in TCP/IP could take advantage of it. When the decision was made to develop a new version of IP ([IPv6](#)), this was the golden opportunity to resolve not just the addressing problems in the older IPv4, but the lack of security as well. New security technology was developed with IPv6 in mind, but since IPv6 has taken years to develop and roll out, and the need for security is *now*, the solution was designed to be usable for both IPv4 and IPv6.

The technology that brings secure communications to the Internet Protocol is called *IP Security*, commonly abbreviated *IPSec* (The capitalization of this abbreviation is variable, so *IPsec* and *IPSEC* are also seen. Though not *IpSeC* or *IPseC*, fortunately. ☺)

Overview of IPSec Services and Functions

IPSec is not a single protocol, but rather a set of services and protocols that provide a complete security solution for an IP network. These services and protocols combine to provide various types of protection. Since IPSec works at the IP layer, it can provide these

protections for any higher layer TCP/IP application or protocol without the need for additional security methods, which is a major strength. Some of the kinds of protection services offered by IPSec include:

- ☉ Encryption of user data for privacy.
- ☉ Authentication of the integrity of a message to ensure that it is not changed en route.
- ☉ Protection against certain types of security attacks, such as replay attacks.
- ☉ The ability for devices to negotiate the security algorithms and keys required to meet their security needs.
- ☉ Two security modes, tunnel and transport, to meet different network needs.



Key Concept: *IPSec* is a contraction of *IP Security*, and consists of a set of services and protocols that provide security to IP networks. It is defined by a sequence of several Internet standards.

IPSec Standards

Since IPSec is actually a collection of techniques and protocols, it is not defined in a single Internet standard. Instead, a collection of RFCs defines the architecture, services and specific protocols used in IPSec. Some of the most important of these are shown in [Table 79](#), all of which were published in November 1998:

Table 79: Important IP Security (IPSec) Standards

RFC Number	Name	Description
2401	<u><i>Security Architecture for the Internet Protocol</i></u>	The main IPSec document, describing the architecture and general operation of the technology, and showing how the different components fit together.
2402	<u><i>IP Authentication Header</i></u>	Defines the IPSec Authentication Header (AH) protocol used for ensuring data integrity and origin verification.
2403	<u><i>The Use of HMAC-MD5-96 within ESP and AH</i></u>	Describes a particular encryption algorithm for use by AH and ESP called Message Digest 5 (MD5), HMAC variant. (Obviously. ☺)
2404	<u><i>The Use of HMAC-SHA-1-96 within ESP and AH</i></u>	Describes a particular encryption algorithm for use by AH and ESP called Secure Hash Algorithm 1 (SHA-1), HMAC variant. (Naturally. ☺)
2406	<u><i>IP Encapsulating Security Payload (ESP)</i></u>	Describes the IPSec Encapsulation Security Payload (ESP) protocol that provides data encryption for confidentiality.
2408	<u><i>Internet Security Association and Key Management Protocol (ISAKMP)</i></u>	Defines methods for exchanging keys and negotiating security associations.

Table 79: Important IP Security (IPSec) Standards

RFC Number	Name	Description
2409	<u><i>The Internet Key Exchange (IKE)</i></u>	Describes the Internet Key Exchange (IKE) protocol used to negotiate security associations and exchange keys between devices for secure communications. Based on ISAKMP and OAKLEY.
2412	<u><i>The OAKLEY Key Determination Protocol</i></u>	Describes a generic protocol for key exchange.

The Future of IPSec

Deployment of IPSec has only really started to take off in the last few years; a major use of the technology is in implementing virtual private networks (VPNs). It appears that the future IPSec is bright, as more and more individuals and companies decide that they need to take advantage of the power of the Internet, while also protecting the security of the data they transport over it.

IPSec General Operation, Components and Protocols

I have a confession to make: I considered not writing about IPSec in this Guide. When you find yourself writing a tome as large as this one, you lose stamina sometimes and there's this urge to avoid writing about confusing subjects. ☺ IPSec isn't the only difficult topic in this Guide but it is definitely a subject that baffles many because it's hard to get your hands around. Most discussions of it jump straight to describing the mechanisms and protocols without providing a general description of what it does and how the pieces fit together. Well, I recognized that IPSec is important and I don't shy away from a challenge. Thus, here's my attempt to provide a framework for understanding IPSec's various bits and pieces.

So, what exactly does IPSec do and how does it do it? In general terms, it provides security services at the IP layer for other TCP/IP protocols and applications to use. What this means is that IPSec provides the tools that devices on a TCP/IP network need in order to communicate securely. When two devices (either end user hosts or intermediate devices such as routers or firewalls) want to engage in secure communications, they set up a *secure path* between themselves that may traverse across many insecure intermediate systems. To accomplish this, they must perform (at least) the following tasks:

1. They must agree on a set of security protocols to use, so that each one sends data in a format the other can understand.
2. They must decide on a specific encryption algorithm to use in encoding data.
3. They must exchange keys that are used to “unlock” data that has been cryptographically encoded.
4. Once this background work is completed, each device must use the protocols, methods and keys previously agreed upon to encode data and send it across the network.

IPSec Core Protocols

To support the activities above, a number of different components comprise the total package known as “IPSec”, as shown in [Figure 116](#). The two main pieces are a pair of technologies sometimes called the *core protocols* of IPSec. These are the ones that actually do the work of encoding information to ensure security. They are:

- ☉ **IPSec Authentication Header (AH):** This protocol provides authentication services for IPSec. What this means is that it allows the recipient of a message to verify that the supposed originator of a message was in fact the one that sent it. It also allows the recipient to verify that none of the data in the datagram has been changed by any intermediate devices en route. It also provides protection against so-called “replay” attacks, where a message is captured by an unauthorized user and re-sent.
- ☉ **Encapsulating Security Payload (ESP):** The Authentication Header ensures integrity of the data in datagram, but not its privacy. When the information in a datagram is “for your eyes only”, it can be further protected using the ESP protocol, which encrypts the payload of the IP datagram.

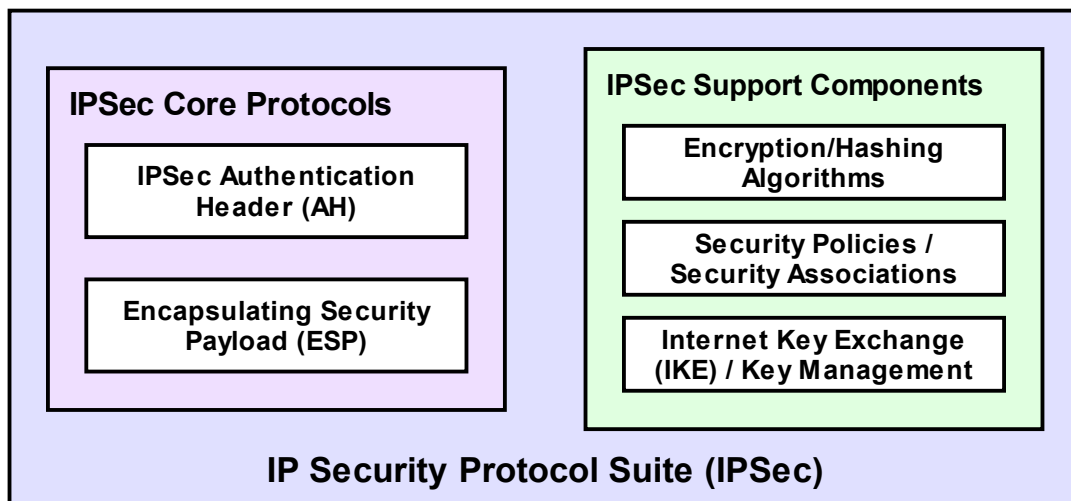

Figure 116: Overview of IPSec Protocols and Components

IPSec Support Components

AH and **ESP** are commonly called “protocols”, though this is another case where the validity of this term is debatable. They are not really distinct protocols but are implemented as headers that are inserted into IP datagrams, as we will see. They thus do the “grunt work” of IPSec, and can be used together to provide both authentication and privacy. However, they cannot operate on their own. For them to function properly they need the support of several other protocols and services. The most important of these include:

-
- ④ **Encryption/Hashing Algorithms:** AH and ESP are generic and do not specify the exact mechanism used for encryption. This gives them the flexibility to work with a variety of such algorithms, and to negotiate which is used as needed. Two common ones used with IPsec are *Message Digest 5 (MD5)* and *Secure Hash Algorithm 1 (SHA-1)*. These are also called *hashing* algorithms because they work by computing a formula called a *hash* based on input data and a key.
 - ④ **Security Policies and Associations, and Management Methods:** Since IPsec provides flexibility in letting different devices decide how they want to implement security, some means is required to keep track of the security relationships between devices. This is done in IPsec using constructs called *security policies* and *security associations*, and by providing ways to exchange security association information (see below).
 - ④ **Key Exchange Framework and Mechanism:** For two devices to exchange encrypted information they need to be able to share keys for unlocking the encryption. They also need a way to exchange security association information. In IPsec, a protocol called the *Internet Key Exchange (IKE)* provides these capabilities.



Key Concept: IPsec consists of a number of different components that work together to provide security services. The two main ones are protocols called the *Authentication Header (AH)* and *Encapsulating Security Payload (ESP)*, which provide authenticity and privacy to IP data in the form of special headers added to IP datagrams.

Well, that's at least a start at providing a framework for understanding what IPsec is all about and how the pieces fit together. We'll examine these components and protocols in more detail as we proceed through this section.

IPsec Architectures and Implementation Methods

The main reason that IPsec is so powerful is that it provides security to IP, the basis for all other TCP/IP protocols. In protecting IP, we are protecting pretty much everything else in TCP/IP as well. An important issue, then, is how exactly we get IPsec into IP? There are several implementation methods for deploying IPsec, which represent different ways that IPsec may modify the overall [layer architecture of TCP/IP](#).

IPsec Implementation Methods

Three different implementation architectures are defined for IPsec in RFC 2401. Which one we use depends on various factors including the version of IP used (v4 versus v6), the requirements of the application and other factors. These in turn rest on a primary implementation decision: whether IPsec should be programmed into all hosts on a network, or just into certain routers or other "intermediate devices".

This implementation decision is one that must be based on the requirements of the network. There are two options: to implement IPsec in end hosts, or in routers.

End Host Implementation

Putting IPSec into all host devices provides the most flexibility and security. It enables “end-to-end” security between any two devices on the network. However, there are many hosts on a typical network, so this means far more work than just implementing IPSec in routers.

Router Implementation

This option is much less work because it means we only make changes to a few routers instead of hundreds or thousands of clients. It only provides protection between pairs of routers that implement IPSec, but this may be sufficient for certain applications such as virtual private networks (VPNs). The routers can be used to provide protection only for the portion of the route that datagrams take outside the organization, leaving connections between routers and local hosts unsecured (or possibly, secured by other means).

IPSec Architectures

Three different architectures are defined that describe methods for how to get IPSec into the TCP/IP protocol stack.

Integrated Architecture

Under ideal circumstances, we would integrate IPSec's protocols and capabilities directly into IP itself. This is the most elegant solution, as it allows all IPSec security modes and capabilities to be provided just as easily as regular IP. No extra hardware or architectural layers are needed.

[IPv6](#) was designed to support IPSec, making this a viable option for hosts or routers. With IPv4, integration would require making changes to the IP implementation on each device, which is often impractical (to say the least!)

“Bump In The Stack” (BITS) Architecture

In this technique, IPSec is made a separate architectural layer between IP and the data link layer; the cute name refers to the fact that IPSec is an extra element in the networking protocol stack, as you can see in [Figure 117](#). IPSec intercepts IP datagrams as they are passed down the protocol stack, processes them to provide security, and then passes them through to the data link layer.

The advantage of this technique is that IPSec can be “retrofitted” to any IP device, since the IPSec functionality is separate from IP. The disadvantage is that there is duplication of effort compared to the integrated architecture. BITS is generally used for IPv4 hosts.

“Bump In The Wire” (BITW) Architecture

In this method we add a hardware device that provides IPSec services. For example, suppose we have a company with two sites. Each has a network that connects to the Internet using a router that is not capable of IPSec functions. We can interpose a special

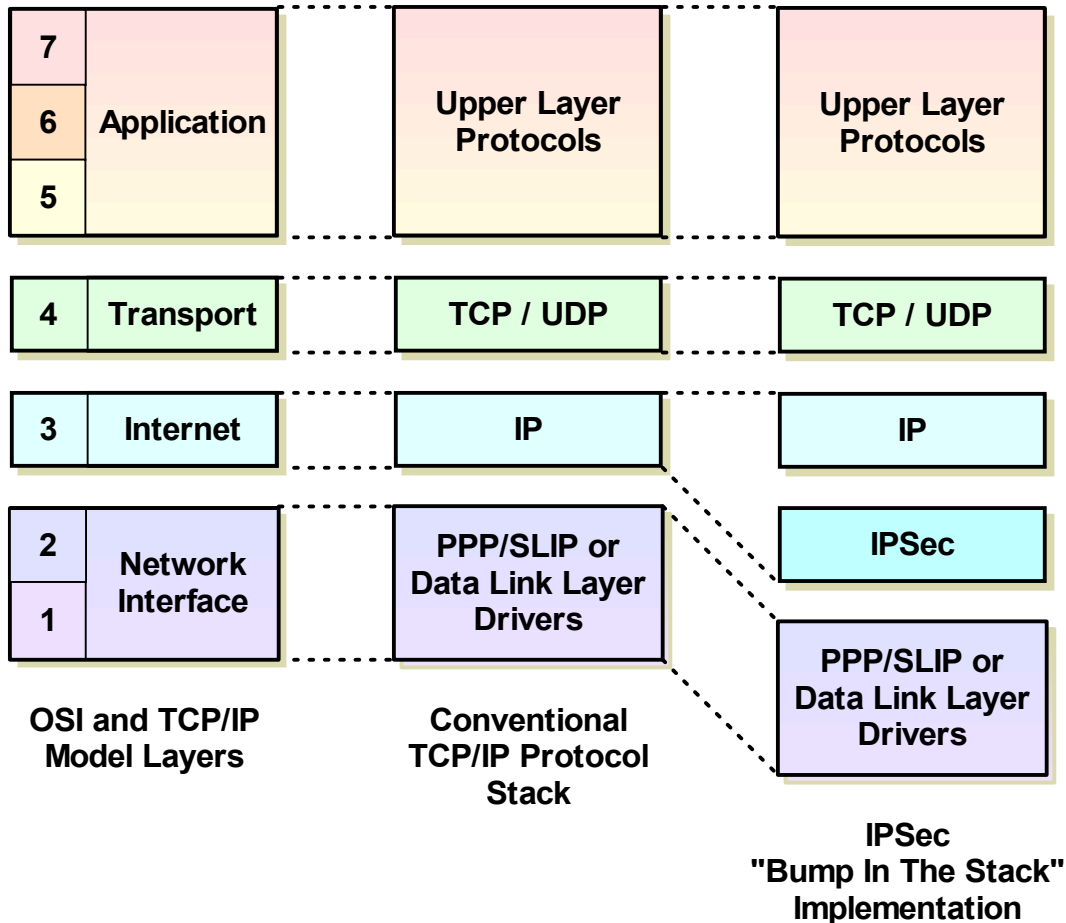

Figure 117: IPSec “Bump In The Stack” (BITS) Architecture

In this type of IPSec implementation, IPSec becomes a separate layer in the TCP/IP stack. It is implemented as software that sits below IP and adds security protection to datagrams created by the IP layer.

“IPSec” device between the router and the Internet at both sites, as shown in [Figure 118](#). These devices will then intercept outgoing datagrams and add IPSec protection to them, and strip it off incoming datagrams.

Just as BITS lets us add IPSec to legacy hosts, BITW can “retrofit” non-IPSec routers to provide security benefits. The disadvantages are complexity and cost.

Parallels Between BITS and BITW

Incidentally, even though BITS and BITW seem quite different, they are really different ways of doing the same thing. In the case of BITS we add an extra software layer that adds security to existing IP datagrams; in BITW this same job is done by distinct hardware devices. In both cases the result is the same, and the implications on the choice of IPSec mode is likewise the same.

As we will see in the next topic, the choice of architecture has an important impact on which of the two IPSec modes can be used.

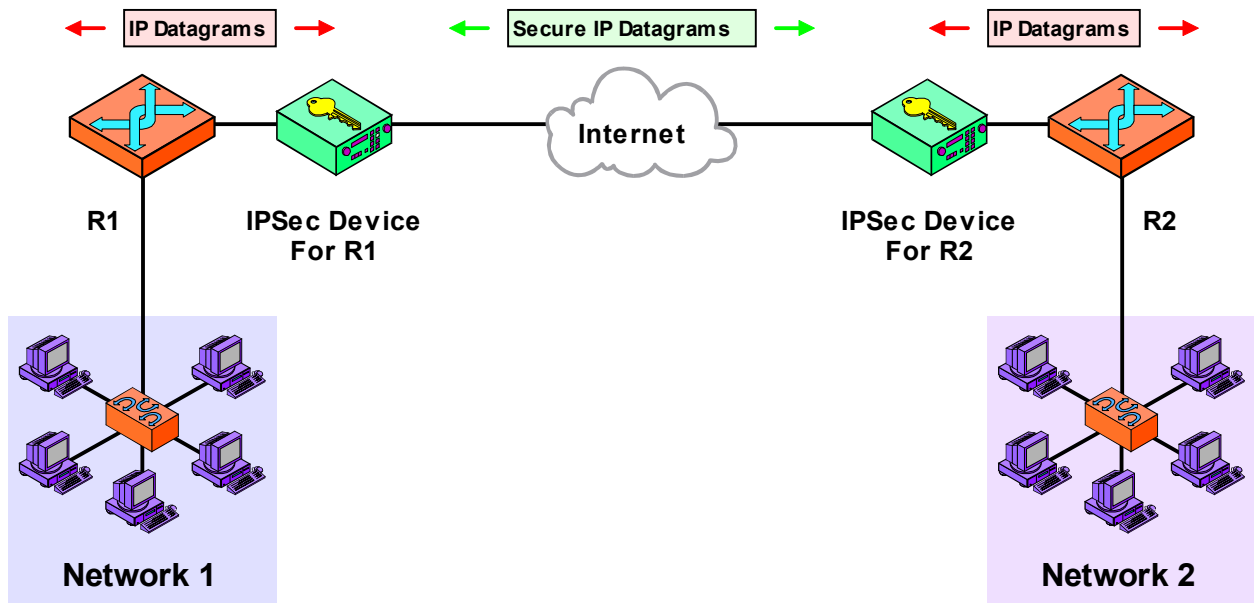

Figure 118: IPsec “Bump In The Wire” (BITW) Architecture

In this IPsec architecture, IPsec is actually implemented in separate devices that sit between the devices that wish to communicate securely. These repackage insecure IP datagrams for transport over the public Internet.



Key Concept: Three different architectures or implementation models are defined for IPsec. The best is *integrated* architecture, where IPsec is built into the IP layer of devices directly. The other two are “*Bump In The Stack*” (*BITS*) and “*Bump In The Wire*” (*BITW*), which both are ways of layering IPsec underneath regular IP, using software and hardware solutions respectively.

IPsec Modes: Transport and Tunnel

Three different basic implementation architectures can be used to provide IPsec facilities to TCP/IP networks. The choice of which implementation we use, as well as whether we implement in end hosts or routers, impacts the specific way that IPsec functions. Two specific *modes* of operation are defined for IPsec that are related to these architectures, called *transport mode* and *tunnel mode*.

IPsec modes are closely related to the function of the two core protocols, the [Authentication Header \(AH\)](#) and [Encapsulating Security Payload \(ESP\)](#). Both of these protocols provide protection by adding to a datagram a header (and possibly other fields) containing security information. The choice of mode does not affect the method by which each generates its header, but rather, changes what specific parts of the IP datagram are protected and how the headers are arranged to accomplish this. In essence, the mode really *describes*, not *prescribes* how AH or ESP do their thing. It is used as the basis for defining other constructs, such as [security associations \(SAs\)](#).

Let’s take a look at how the two modes work.

Transport Mode

As its name suggests, in transport mode, the protocol protects the message passed down to IP from the transport layer. The message is processed by AH/ESP and the appropriate header(s) added in front of the transport (UDP or TCP) header. The IP header is then added in front of that by IP.

Another way of looking at this is as follows. Normally the transport layer packages data for transmission and sends it to IP. From IP's perspective, this transport layer message is the payload of the IP datagram. When IPSec is used in transport mode, the IPSec header is applied only over this IP payload, *not* the IP header. The AH and/or ESP headers appears between the original, single IP header and the IP payload. This is illustrated in [Figure 119](#).

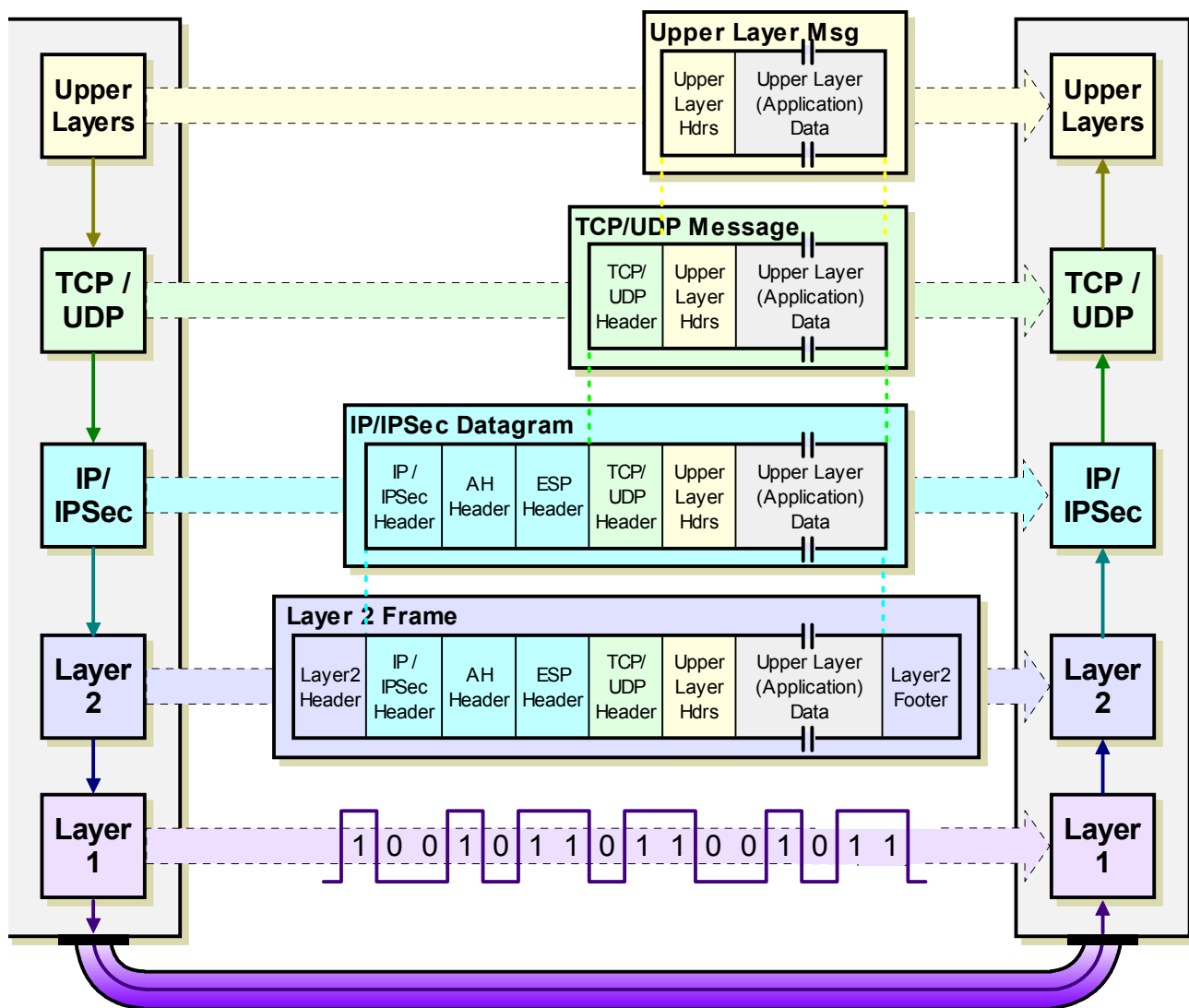

Figure 119: IPSec Transport Mode Operation

When IPSec operates in transport mode, it is integrated with IP and used to transport the upper layer (TCP/UDP) message directly. After processing, the datagram has just one IP header that contains the AH and/or ESP IPSec headers. Contrast to [Figure 120](#).

Tunnel Mode

In this mode, IPsec is used to protect a complete **encapsulated** IP datagram after the IP header has already been applied to it. The IPsec headers appear in front of the original IP header, and then a **new** IP header is added in front of the IPsec header. That is to say, the entire original IP datagram is secured and then encapsulated within another IP datagram. This is shown in [Figure 120](#).

Comparing Transport and Tunnel Modes

The bottom line in understanding the difference between these two is this: tunnel mode protects the original IP datagram as a whole, header and all, while transport mode does not. Thus, in general terms, the order of the headers is as follows:

- ☉ **Transport Mode:** IP header, IPsec headers (AH and/or ESP), IP payload (including transport header).
- ☉ **Tunnel Mode:** New IP header, IPsec headers (AH and/or ESP), old IP header, IP payload.

Again, this is a simplified view of how IPsec datagrams are constructed; the reality is significantly more complex. The exact way that the headers are arranged in an IPsec datagram in both transport and tunnel modes depends on which version of IP is being used; IPv6 uses extension headers which must be arranged in a particular way when IPsec is used. The header placement also depends on which IPsec protocol is being used: AH or ESP. Note that it is also possible to apply both AH and ESP to the same datagram; if so, the AH header always appears before the ESP header.

There are thus three variables and eight basic combinations of mode (tunnel or transport), IP version (IPv4 or IPv6) and protocol (AH or ESP). The two topics on [AH](#) and [ESP](#) describe the four format combinations of transport/tunnel mode and IPv4/IPv6 applicable to each protocol. Note that ESP also includes an ESP trailer that goes **after** the data protected.

You could probably tell by reading these descriptions how the two modes relate to the choice of IPsec architecture from [the preceding topic](#). Transport mode requires that IPsec be integrated into IP, because AH/ESP must be applied as the original IP packaging is performed on the transport layer message. This is often the choice for implementations requiring end-to-end security with hosts that run IPsec directly.

Tunnel mode represents an encapsulation of IP within the combination of IP+IPsec. Thus, it corresponds with the BITS and BITW implementations, where IPsec is applied after IP has processed higher-layer messages and already added its header. Tunnel mode is a common choice for VPN implementations, which are based on tunneling of IP datagrams through an unsecured network such as the Internet.

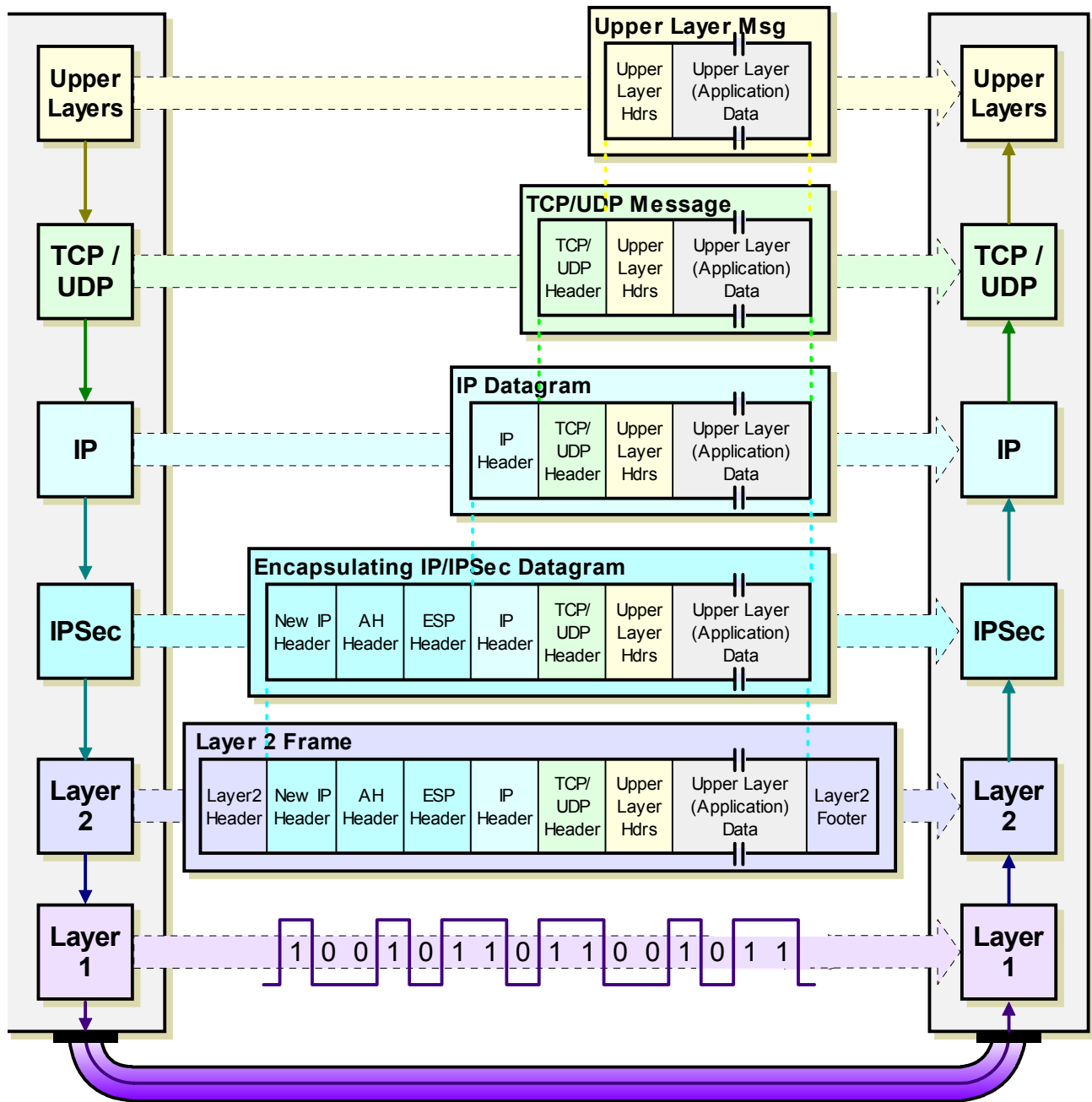

Figure 120: IPsec Tunnel Mode Operation

IPsec *tunnel mode* is so named because it represents an encapsulation of a complete IP datagram, forming a virtual tunnel between IPsec-capable devices. The IP datagram is passed to IPsec, where a new IP header is created with the AH and/or ESP IPsec headers added. Contrast to [Figure 119](#).



Key Concept: IPsec has two basic modes of operation. In *transport mode*, IPsec AH and/or ESP headers are added as the original IP datagram is created; this mode is associated with integrated IPsec architectures. In *tunnel mode*, the original IP datagram is created normally, then the entire datagram is encapsulated into a new IP datagram containing the AH/ESP IPsec headers. This mode is most commonly used with “Bump In The Stack” and “Bump In The Wire” implementations.

IPsec Security Associations and the Security Association Database (SAD); Security Policies and the Security Policy Database (SPD); Selectors; the Security Parameter Index (SPI)

Woah, there sure is a lot of "security" stuff in that topic title. Those items are all closely related, and important to understand before we proceed to looking at the core IPsec protocols themselves. These constructs are used to guide the operation of IPsec in a general way and also in particular exchanges between devices. They control how IPsec works and ensure that each datagram coming into or leaving an IPsec-capable device is properly treated.

Where to start... where to start. ☺ Let's begin by considering the problem of how to apply security in a device that may be handling many different exchanges of datagrams with others. There is overhead involved in providing security, so we do not want to do it for every message that comes in or out. Some types of messages may need more security, others less. Also, exchanges with certain devices may require different processing than others.

Security Policies, Security Associations and Associated Databases

To manage all of this complexity, IPsec is equipped with a flexible, powerful way of specifying how different types of datagrams should be handled. To understand how this works, we must first define two important logical concepts:

- ☉ **Security Policies:** A *security policy* is a rule that is programmed into the IPsec implementation that tells it how to process different datagrams received by the device. For example, security policies are used to decide if a particular packet needs to be processed by IPsec or not; those that do not bypass AH and ESP entirely. If security is required, the security policy provides general guidelines for how it should be provided, and if necessary, links to more specific detail.

Security policies for a device are stored in the device's *Security Policy Database (SPD)*.

- ☉ **Security Associations:** A *Security Association (SA)* is a set of security information that describes a particular kind of secure connection between one device and another. You can consider it a "contract", if you will, that specifies the particular security mechanisms that are used for secure communications between the two.

A device's security associations are contained in its *Security Association Database (SAD)*.

It's often hard to distinguish the SPD and the SAD, since they are similar in concept. The main difference between them is that security policies are general while security associations are more specific. To determine what to do with a particular datagram, a device first checks the SPD. The security policies in the SPD may reference a particular security association in the SAD. If so, the device will look up that security association and use it for processing the datagram.

Selectors

One issue we haven't covered yet is how a device determines what policies or SAs to use for a specific datagram. Again here, IPSec defines a very flexible system that lets each security association define a set of rules for choosing datagrams that the SA applies to. Each of these rule sets is called a *selector*. For example, a selector might be defined that says that a particular range of values in the *Source Address* of a datagram, combined with another value in the *Destination Address*, means a specific SA must be used for the datagram.

Let's now come back to security associations, which are a very important concept in IPSec. Each secure communication that a device makes to another requires that an SA be established. SAs are unidirectional, so each one only handles either inbound or outbound traffic for a particular device. This allows different levels of security to be implemented for a flow from device *A* to device *B*, than for traffic coming from device *B* to device *A*. In a bidirectional communication of this sort, both *A* and *B* would have two SAs; *A* would have SAs we could call "SAdeviceBin" and "SAdeviceBout". Device *B* would have SAs "SAdeviceAin" and "SAdeviceAout".

Security Association Triples and the Security Parameter Index (SPI)

Security associations don't actually have names, however. They are instead defined by a set of three parameters, called a *triple*:

- ① **Security Parameter Index (SPI):** A 32-bit number that is chosen to uniquely identify a particular SA for any connected device. The SPI is placed in AH or ESP datagrams and thus links each secure datagram to the security association. It is used by the recipient of a transmission so it knows what SA governs the datagram.
- ② **IP Destination Address:** The address of the device for whom the SA is established.
- ③ **Security Protocol Identifier:** Specifies whether this association is for AH or ESP. If both are in use with this device they have separate SAs.

As you can see, the two security protocols AH and ESP are dependent on security associations and policies and the various databases that control their operation. Management of these databases is important, but another whole complex subject. Generally, SAs can either be set up manually (which is of course extra work) or an automated system can be deployed using a protocol like [IKE](#).

Confused? I don't blame you, despite my best efforts, and remember that this is all **highly** simplified. Welcome to the wonderful world of networking security. If you are ever besieged by insomnia, I **highly** recommend RFC 2401. 😊

IPSec Authentication Header (AH)

One of the two core security protocols in IPSec is the *Authentication Header (AH)*. This is another protocol whose name has been well chosen: AH is a protocol that provides *authentication* of either all or part of the contents of a datagram through the addition of a *header* that is calculated based on the values in the datagram. What parts of the datagram are used for the calculation, and the placement of the header, depends on the mode ([tunnel or transport](#)) and the version of IP (IPv4 or IPv6).

The operation of the AH protocol is surprisingly simple—especially for any protocol that has anything to do with network security. It can be considered analogous to the algorithms used to calculate checksums or perform CRC checks for error detection. In those cases, a standard algorithm is used by the sender to compute a checksum or CRC code based on the contents of a message. This computed result is transmitted along with the original data to the destination, which repeats the calculation and discards the message if any discrepancy is found between its calculation and the one done by the source.

This is the same idea behind AH, except that instead of using a simple algorithm known to everyone, we use a special hashing algorithm and a specific key known only to the source and the destination. A [security association](#) between two devices is set up that specifies these particulars so that the source and destination know how to perform the computation but nobody else can. On the source device, AH performs the computation and puts the result (called the *Integrity Check Value* or *ICV*) into a special header with other fields for transmission. The destination device does the same calculation using the key the two devices share, which enables it to see immediately if any of the fields in the original datagram were modified (either due to error or malice).

It's important that I point out explicitly that just as a checksum doesn't change the original data, neither does the ICV calculation change the original data. The presence of the AH header allows us to verify the integrity of the message, but doesn't encrypt it. Thus, AH provides *authentication* but not *privacy* (that's what ESP is for. No, I don't mean using a psychic, I mean [the other IPSec core protocol!](#))

Authentication Header Datagram Placement and Linking

The calculation of the authentication header is similar for both IPv4 and IPv6. One difference is in the exact mechanism used for placing the header into the datagram and for linking the headers together. I'll describe IPv6 first since it is simpler, as AH was really designed to fit into IPv6's mechanism for this.

IPv6 Authentication Header Placement and Linking

The AH is inserted into the IP datagram as an extension header, following the [normal IPv6 rules for extension header linking](#). It is linked by the previous header (extension or main) putting into its *Next Header* field the assigned value for the AH header (51). The AH header then links to the next extension header or the transport layer header using its *Next Header* field.

In transport mode, the AH is placed into the main IP header and appears before any *Destination Options* header containing options intended for the final destination, and before an *ESP* header if present, but after any other extension headers. In tunnel mode, it appears as an extension header of the new IP datagram that encapsulates the original one being tunneled. This is shown graphically in [Figure 121](#).

IPv4 Authentication Header Placement and Linking

A method that is similar to the IPv6 header linking technique is employed. In an IPv4 datagram, the *Protocol* field indicates the identity of the higher layer protocol (typically TCP or UDP) carried in the datagram. As such, this field “points” to the next header, which is at the front of the IP payload. AH takes this value and puts it into its *Next Header* field, and then places the protocol value for AH itself (51 decimal) into the IP *Protocol* field. This makes the IP header “point” to the AH, which then “points” to whatever the IP datagram pointed to before.

Again, in transport mode, the authentication header is added after the main IP header of the original datagram; in tunnel mode it is added after the new IP header that encapsulates the original datagram being tunneled. This is shown in [Figure 122](#).



Key Concept: The IPsec *Authentication Header (AH)* protocol allows the recipient of a datagram to verify its authenticity. It is implemented as a header added to an IP datagram that contains an *integrity check value* computed based on the values of the fields in the datagram. This value can be used by the recipient to ensure that the data has not been changed in transit. The Authentication Header does not encrypt data and thus does not ensure the privacy of transmissions.

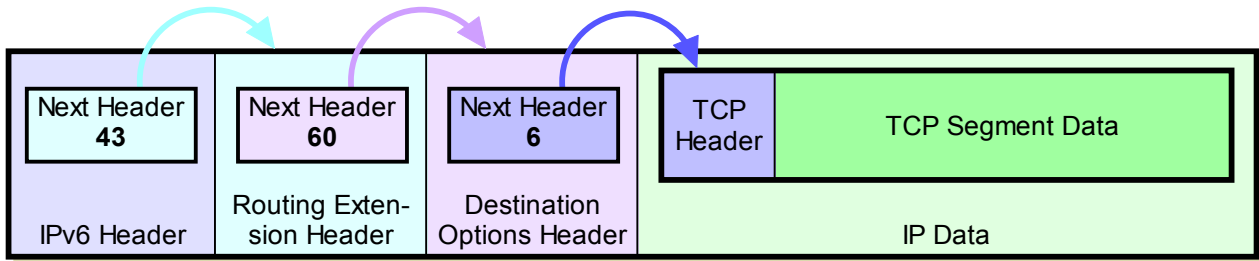

Original IPv6 Datagram Format (Including Routing Extension Header and Destination-Specific Destination Options Extension Header)

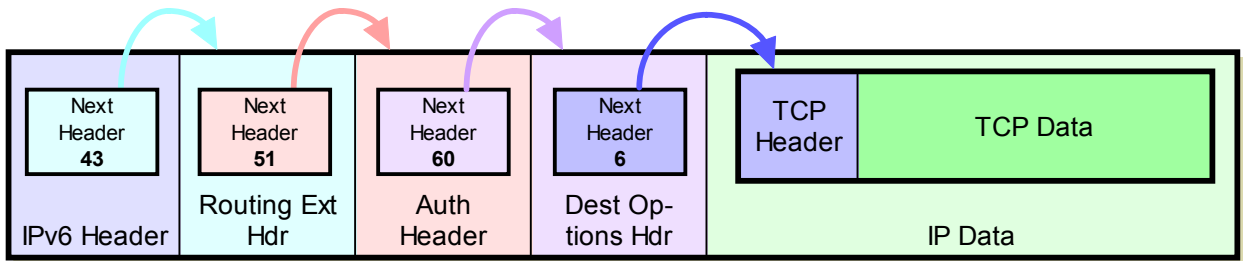

Authenticated Fields

IPv6 AH Datagram Format - IPsec Transport Mode

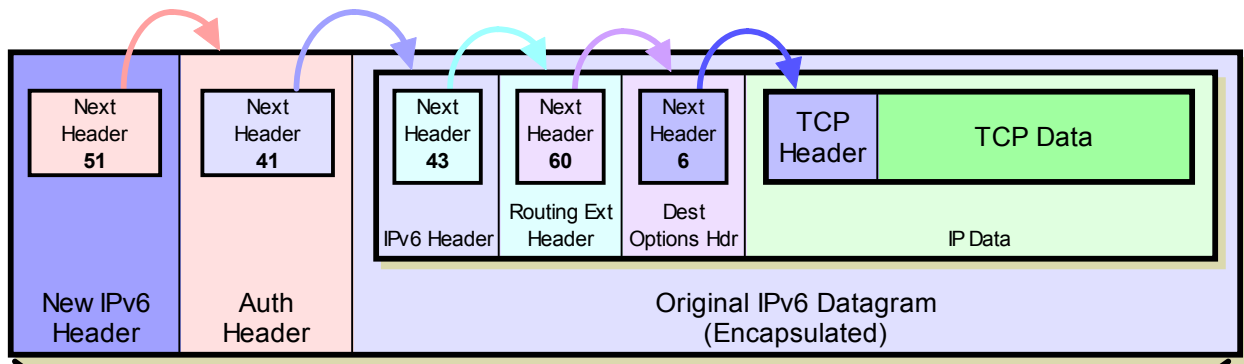

Authenticated Fields

IPv6 AH Datagram Format - IPsec Tunnel Mode

Figure 121: IPv6 Datagram Format With IPsec Authentication Header (AH)

At top is an example IPv6 datagram with two extension headers linked using the standard IPv6 mechanism (see [Figure 106](#).) When AH is applied in transport mode, it is simply added as a new extension header (shown in pink) that goes between the *Routing* extension header and the *Destination Options* header. In tunnel mode, the entire original datagram is encapsulated into a new IPv6 datagram that contains the Authentication Header. In both cases the *Next Header* fields are used to link each header one to the next. Note the use of Next Header value 41 in tunnel mode, which is the value for the encapsulated IPv6 datagram.

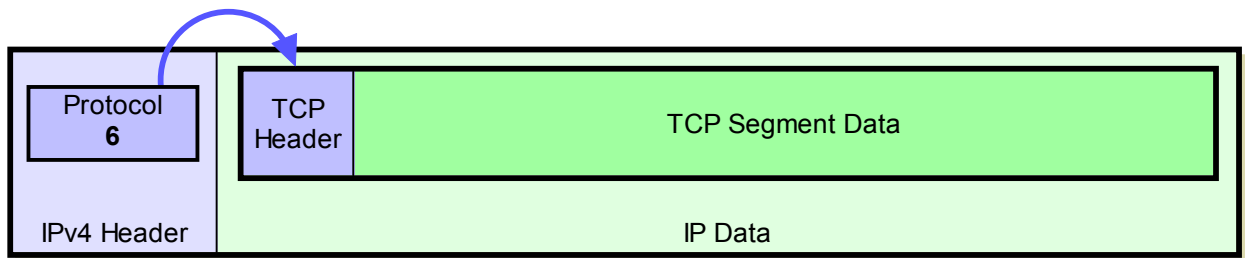

Original IPv4 Datagram Format

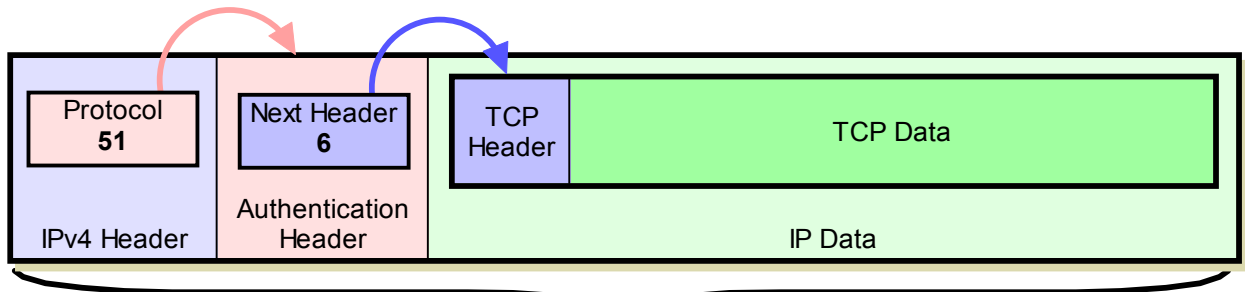

Authenticated Fields

IPv4 AH Datagram Format - IPsec Transport Mode

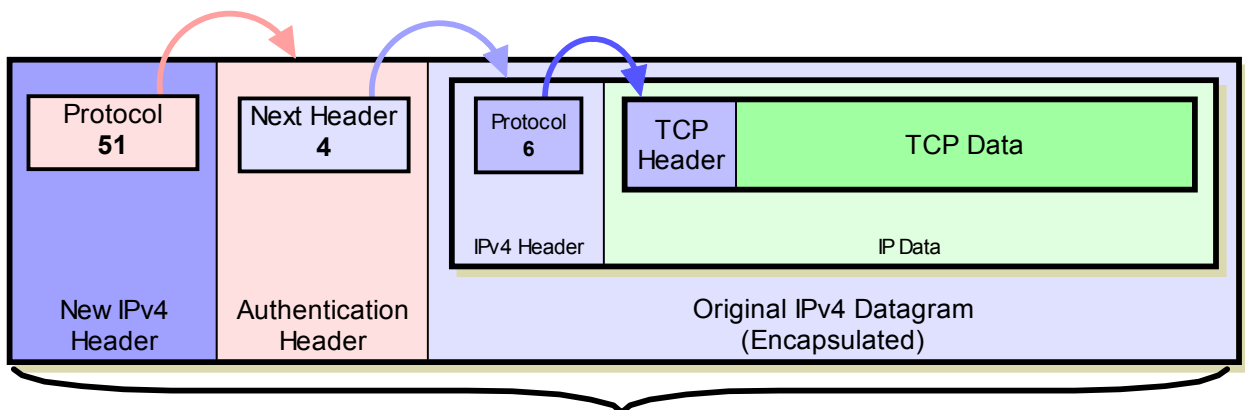

Authenticated Fields

IPv4 AH Datagram Format - IPsec Tunnel Mode

Figure 122: IPv4 Datagram Format With IPsec Authentication Header (AH)

At top is an example IPv4 datagram; it may or may not contain IPv4 options (which are not distinct entities as they are in IPv6). In transport mode, the authentication header is added between the IP header and the IP data; the *Protocol* field of the IP header points to it, while its *Next Header* field contains the IP header's prior protocol value (in this case 6, for TCP.) In tunnel mode the IPv4 datagram is encapsulated into a new IPv4 datagram that includes the AH header. Note in tunnel mode, the AH header's use of the value 4 (which means IPv4) in its *Next Header*.

Authentication Header Format

The format of the Authentication Header itself is described in [Table 80](#) and shown in [Figure 123](#).

Table 80: IPSec Authentication Header (AH) Format

Field Name	Size (bytes)	Description
Next Header	1	Next Header: Contains the protocol number of the next header after the AH. Used to link headers together.
Payload Len	1	Payload Length: Despite its name, this field measures the length of the authentication header itself, not the payload. (I wonder what the history is behind that!) It is measured in 32 bit units, with 2 subtracted for consistency with how header lengths are normally calculated in IPv6.
Reserved	2	Reserved: Not used; set to zeroes.
SPI	4	Security Parameter Index (SPI): A 32-bit value that when combined with the destination address and security protocol type (which here is obviously the one for AH) identifies the security association to be used for this datagram. See the topic on security associations for more details.
Sequence Number	4	Sequence Number: This is a counter field that is initialized to zero when a security association is formed between two devices, and then incremented for each datagram sent using that SA. This uniquely identifies each datagram on an SA and is used to provide protection against replay attacks by preventing the retransmission of captured datagrams.
Authentication Data	Variable	Authentication Data: This field contains the result of the hashing algorithm performed by the AH protocol, the Integrity Check Value (ICV).

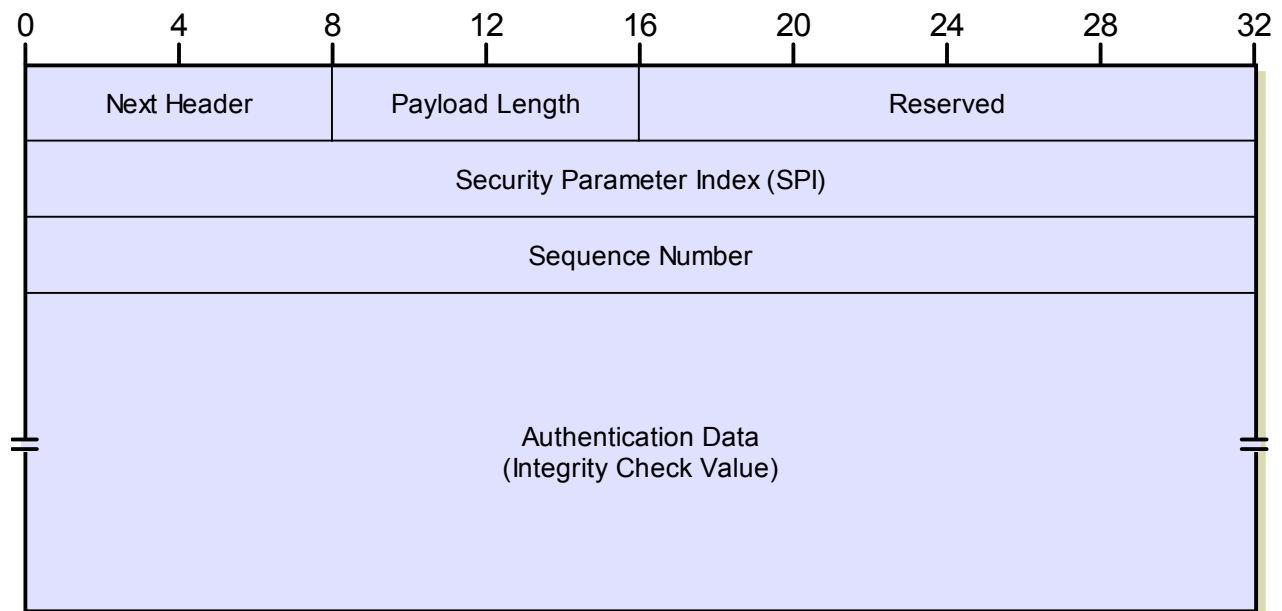

Figure 123: IPSec Authentication Header (AH) Format

The size of the *Authentication Data* field is variable to support different datagram lengths and hashing algorithms. Its total length must be a multiple of 32 bits. Also, the entire header must be a multiple of either 32 bits (for IPv4) or 64 bits (for IPv6), so additional padding may be added to the *Authentication Data* field if necessary.

You may also notice that no IP addresses appear in the header, which is a prerequisite for it being the same for both IPv4 and IPv6.

IPSec Encapsulating Security Payload (ESP)

The IPSec [Authentication Header \(AH\)](#) provides integrity authentication services to IPSec-capable devices, so they can verify that messages are received intact from other devices. For many applications, however, this is only one piece of the puzzle. We want to not only protect against intermediate devices changing our datagrams, we want to protect against them examining their contents as well. For this level of private communication, AH is not enough; we need to use the *Encapsulating Security Payload (ESP)* protocol.

The main job of ESP is to provide the privacy we seek for IP datagrams by *encrypting* them. An encryption algorithm combines the data in the datagram with a key to transform it into an encrypted form. This is then repackaged using a special format that we will see shortly, and transmitted to the destination, which decrypts it using the same algorithm. ESP also supports its own authentication scheme like that used in AH, or can be used in conjunction with AH.

Encapsulating Security Payload Fields

ESP has several fields that are the same as those used in AH, but packages its fields in a very different way. Instead of having just a header, it divides its fields into three components:

- ④ **ESP Header:** This contains two fields, the *SPI* and *Sequence Number*, and comes before the encrypted data. Its placement depends on whether ESP is used in transport mode or tunnel mode, as explained in [the topic on IPSec modes](#).
- ④ **ESP Trailer:** This section is placed after the encrypted data. It contains padding that is used to align the encrypted data, through a *Padding* and *Pad Length* field. Interestingly, it also contains the *Next Header* field for ESP.
- ④ **ESP Authentication Data:** This field contains an *Integrity Check Value (ICV)*, computed in a manner similar to how the AH protocol works, for when ESP's optional authentication feature is used.

There are two reasons why these fields are broken into pieces like this. The first is that some encryption algorithms require the data to be encrypted to have a certain block size, and so padding must appear after the data and not before it. That's why padding appears in the ESP Trailer. The second is that the *ESP Authentication Data* appears separately because it is used to authenticate the rest of the encrypted datagram **after encryption**. This means it cannot appear in the ESP Header or ESP Trailer.

Encapsulating Security Payload Operations and Field Use

Let's try to explain this procedurally, by considering three basic steps performed by ESP.

1. Header Calculation and Placement

The first thing to consider is how the ESP header is placed; this is similar to how AH works:

- ☉ **IPv6:** The *ESP Header* is inserted into the IP datagram as an extension header, following [the normal IPv6 rules for extension header linking](#). In transport mode, it appears before a *Destination Options* header containing options intended for the final destination, but after any other extension headers, if present. In tunnel mode, it appears as an extension header of the new IP datagram that encapsulates the original one being tunneled. This can be seen in [Figure 124](#).
- ☉ **IPv4:** As with the AH, the *ESP Header* is placed after the normal IPv4 header. In transport mode, it appears after the original IP header; in tunnel mode, after the IP header of the new datagram encapsulating the original. This is shown in [Figure 125](#).

2. Trailer Calculation and Placement

The *ESP Trailer* is appended to the data to be encrypted. ESP then performs the encryption. The payload (TCP/UDP message or encapsulated IP datagram) and the ESP trailer are both encrypted, but the *ESP Header* is not. Note again that any other IP headers that appear between the ESP header and the payload are also encrypted. In IPv6 this can include a *Destination Options* extension header.

Normally, the *Next Header* field would appear in the ESP header and would be used to link the ESP header to the header that comes after it. However, the *Next Header* field in ESP appears in the trailer and not the header, which makes the linking seem a bit strange in ESP. The method is the same as that used in AH and in IPv6 in general, with the *Next Header* and/or *Protocol* fields used to tie everything together. However, in ESP the *Next Header* field appears *after* the encrypted data, and so “points back” to one of the following: a *Destination Options* extension header (if present), a TCP/UDP header (in transport mode) or an IPv4/IPv6 header (in tunnel mode). This too is shown in [Figure 124](#) and [Figure 125](#).

3. ESP Authentication Field Calculation and Placement

If the optional ESP authentication feature is used, the authentication field is computed over the entire ESP datagram (except the *Authentication Data* field itself, of course). This includes the ESP header, payload and trailer.



Key Concept: The IPsec *Encapsulating Security Payload* protocol allows the contents of a datagram to be encrypted, to ensure that only the intended recipient is able to see the data. It is implemented using three components: an *ESP Header* added to the front of a protected datagram, an *ESP Trailer* that follows the protected data, and an optional *ESP Authentication Data* field that provides authentication services similar to those provided by the [Authentication Header \(AH\)](#).

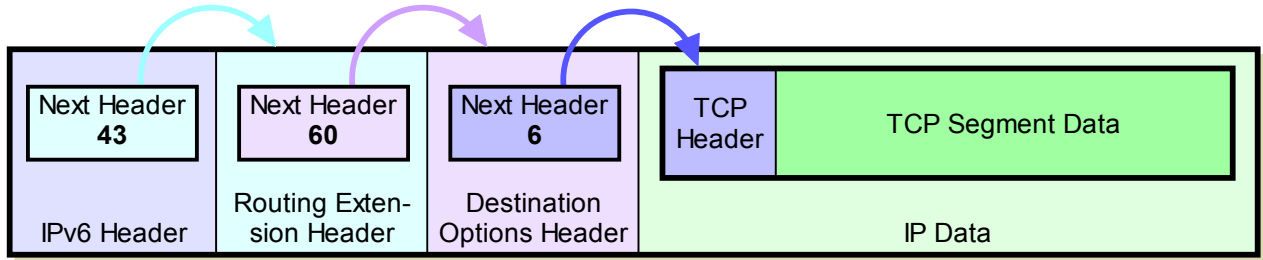

Original IPv6 Datagram Format (Including Routing Extension Header and Destination-Specific Destination Options Extension Header)

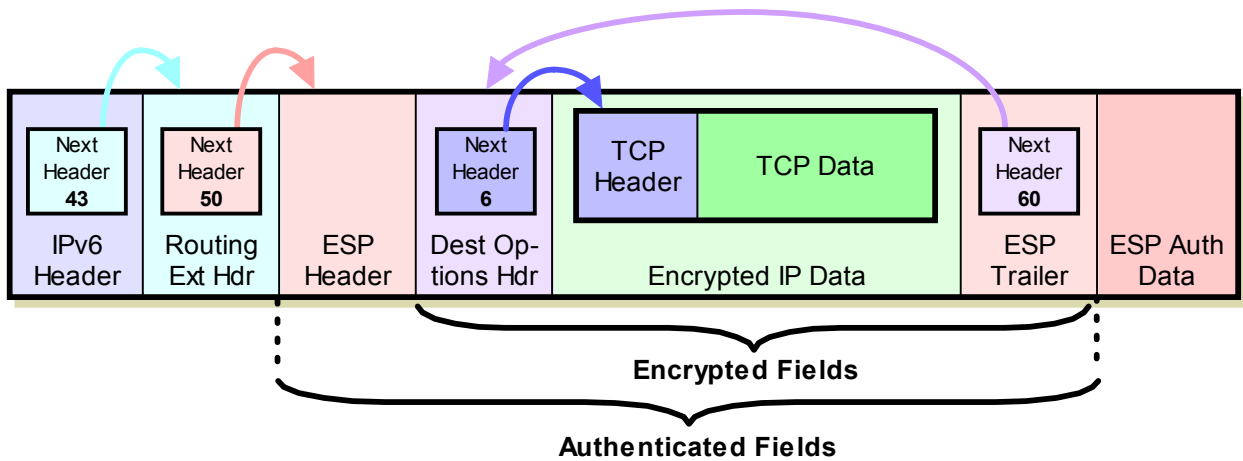

IPv6 ESP Datagram Format - IPsec Transport Mode

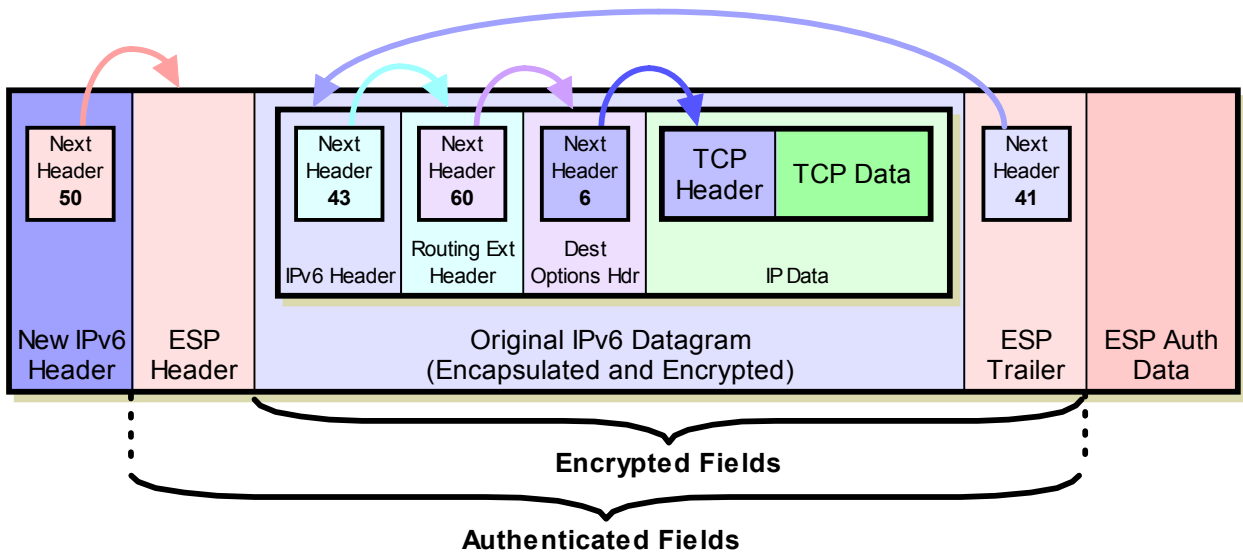

IPv6 ESP Datagram Format - IPsec Tunnel Mode

Figure 124: IPv6 Datagram Format With IPsec Encapsulating Security Payload (ESP)

At top is the same example IPv6 datagram with two extension headers shown in Figure 121. When ESP is applied in transport mode, the *ESP Header* is added to the existing datagram as in AH, and the *ESP Trailer* and *ESP Authentication Data* are placed at the end. In tunnel mode, the *ESP Header* and *Trailer* bracket the entire encapsulated IPv6 datagram. Note the encryption and authentication coverage in each case, and also how the *Next Header* field “points back” into the datagram since it appears in the ESP Trailer.

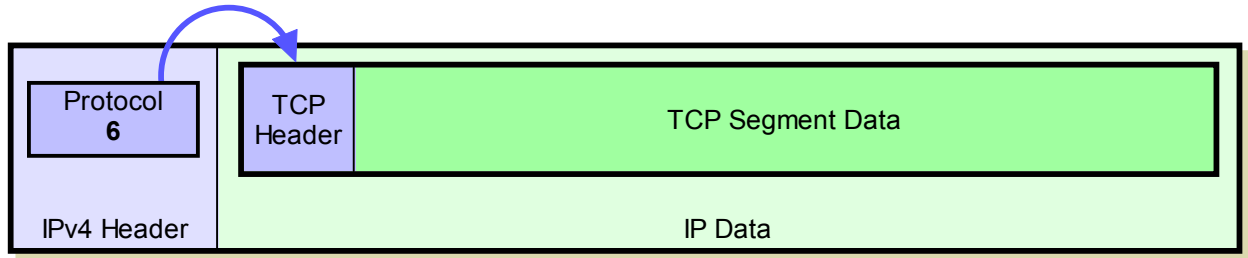

Original IPv4 Datagram Format

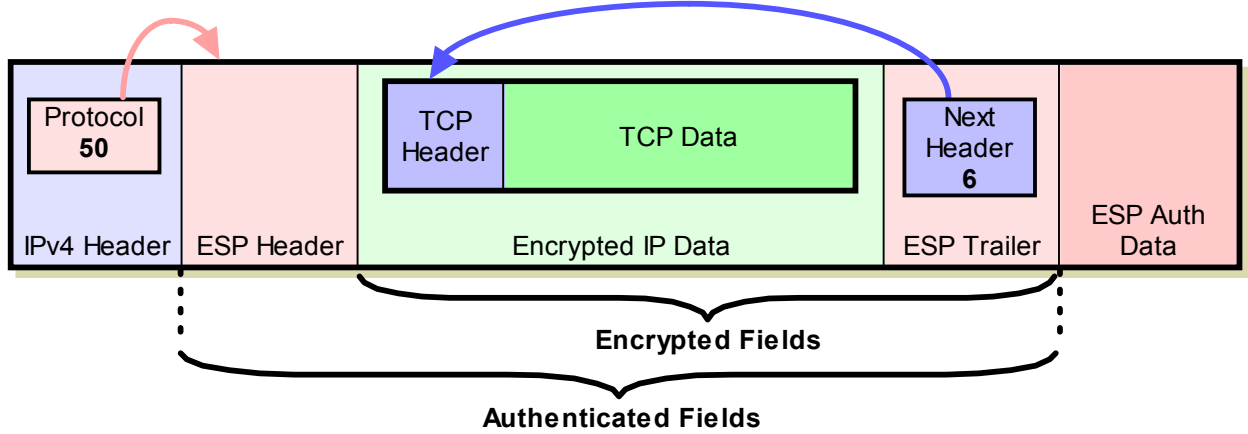

IPv4 ESP Datagram Format - IPsec Transport Mode

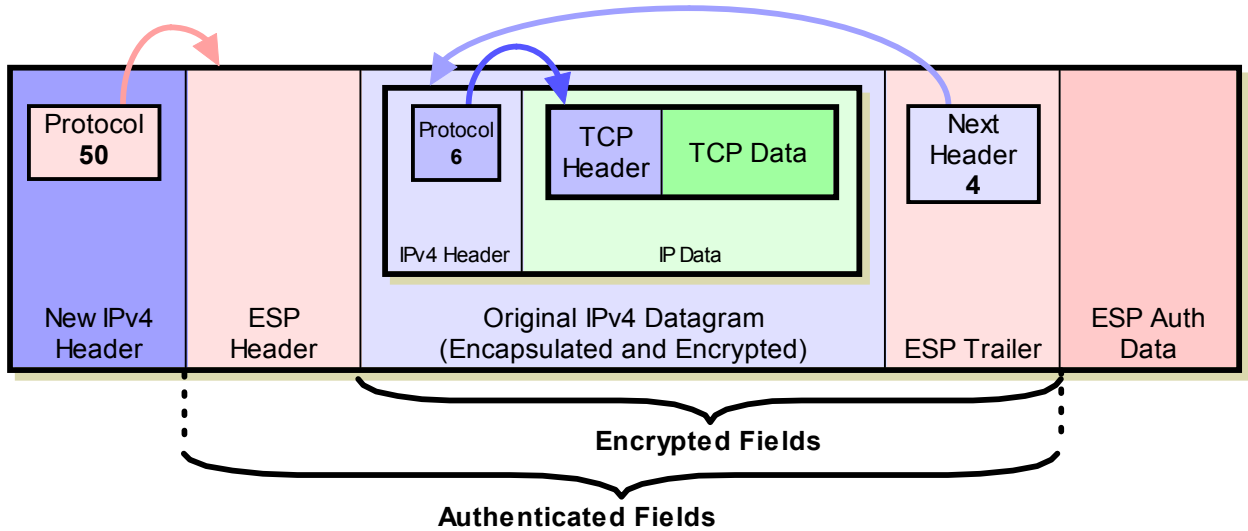

IPv4 ESP Datagram Format - IPsec Tunnel Mode

Figure 125: IPv4 Datagram Format With IPsec Encapsulating Security Payload (ESP)

At top is the same sample IPv4 datagram shown in Figure 122. When this datagram is processed by ESP in transport mode, the ESP Header is placed between the IPv4 header and data, with the ESP Trailer and ESP Authentication Data following. In tunnel mode, the entire original IPv4 datagram is surrounded by these ESP components, rather than just the IPv4 data. Again, as in Figure 124, note the encryption and authentication coverage, and how the Next Header field “points back” to specify the identity of the encrypted data/datagram.

Encapsulating Security Payload Format

The format of the ESP sections and fields is described in [Table 81](#) and shown in [Figure 126](#). I have shown explicitly in each the encryption and authentication coverage of the fields, which will hopefully cause all that stuff I just wrote to make at least a bit more sense.

Table 81: IPSec Encapsulating Security Payload (ESP) Format

Section	Field Name	Size (bytes)	Description	Encryption Coverage	Authentication Coverage
ESP Header	<i>SPI</i>	4	Security Parameter Index (SPI): A 32-bit value that is combined with the destination address and security protocol type to identify the security association to be used for this datagram. See the topic on security associations for more details.		
	<i>Sequence Number</i>	4	Sequence Number: A counter field initialized to zero when a security association is formed between two devices, and then incremented for each datagram sent using that SA. This is used to provide protection against replay attacks.		
Payload	<i>Payload Data</i>	Variable	Payload Data: The encrypted payload data, consisting of a higher layer message or encapsulated IP datagram. May also include support information such as an initialization vector, required by certain encryption methods.		
ESP Trailer	<i>Padding</i>	Variable (0 to 255)	Padding: Additional padding bytes included as needed for encryption or for alignment.		
	<i>Pad Length</i>	1	Pad Length: The number of bytes in the preceding Padding field.		
	<i>Next Header</i>	1	Next Header: Contains the protocol number of the next header in the datagram. Used to chain together headers.		
ESP Authentication Data		Variable	ESP Authentication Data: This field contains the <i>Integrity Check Value (ICV)</i> resulting from the application of the optional ESP authentication algorithm.		

The *Padding* field is used when encryption algorithms require it. *Padding* is also used to make sure that the *ESP Trailer* ends on a 32-bit boundary. That is, the size of the *ESP Header* plus *Payload* plus *ESP Trailer* must be a multiple of 32 bits. The *ESP Authentication Data* must also be a multiple of 32 bits.

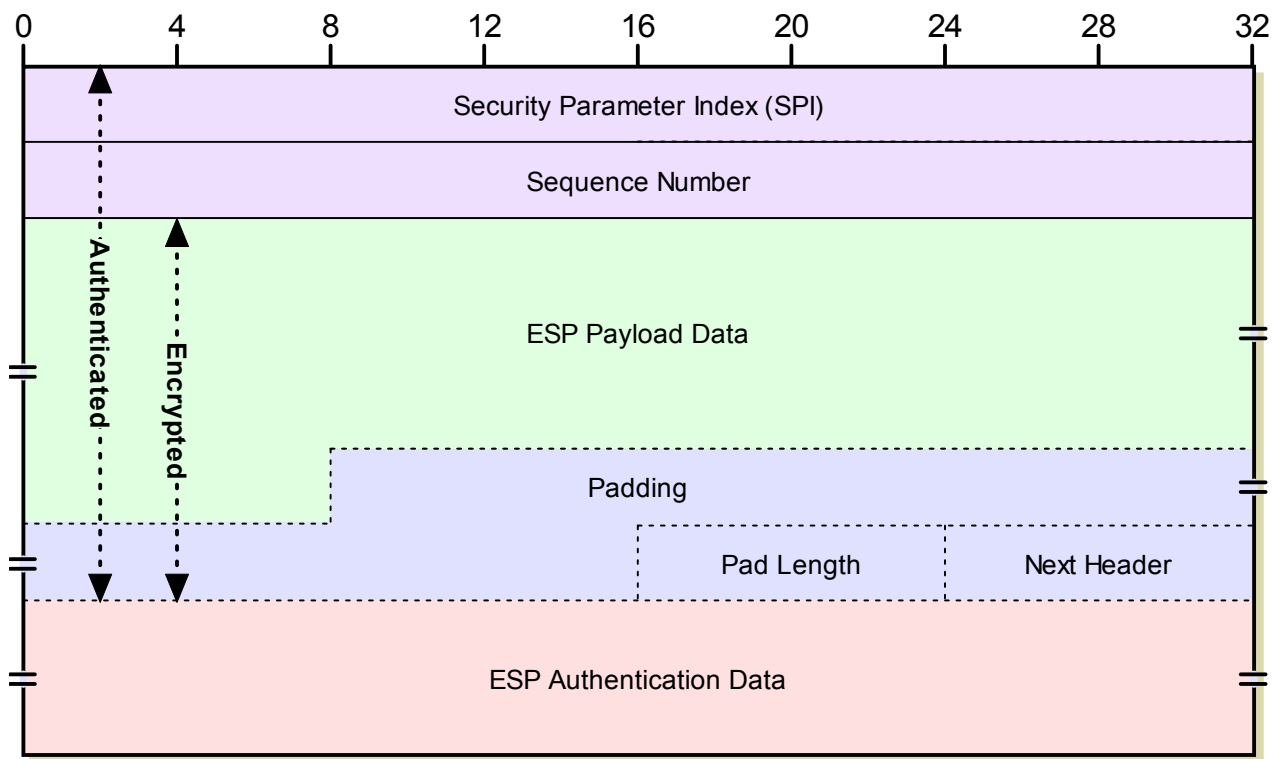

Figure 126: IPsec Encapsulating Security Payload (ESP) Format

Note that most of the fields and sections in this format are variable length. The exceptions are the *SPI* and *Sequence Number* fields, which are 4 bytes long, and the *Pad Length* and *Next Header* fields, 1 byte each.

IPsec Key Exchange (IKE)

IPsec, like many secure networking protocol sets, is based on the concept of a “shared secret”. Two devices that want to send information securely encode and decode it using a piece of information that only they know. Anyone who isn’t “in” on the secret is able to intercept the information but is prevented either from reading it (if **ESP** is used to encrypt the payload) or from tampering with it undetected (if **AH** is used). Before either AH or ESP can be used, however, it is necessary for the two devices to exchange the “secret” that the security protocols themselves will use. The primary support protocol used for this purpose in IPsec is called *Internet Key Exchange (IKE)*.

IKE is defined in RFC 2409, and is one of the more complicated of the IPsec protocols to comprehend. In fact, it is simply impossible to truly understand more than a real simplification of its operation without significant background in cryptography. I don’t have a background in cryptography and I must assume that you, my reader, do not either. So rather than fill this topic with baffling acronyms and unexplained concepts, I will just provide a brief outline of IKE and how it is used.

IKE Overview and Relationship to Other Key Exchange Methods

The purpose of IKE is to allow devices to exchange information required for secure communication. As the title suggests, this includes cryptographic keys used for encoding authentication information and performing payload encryption. IKE works by allowing IPSec-capable devices to exchange **security associations (SAs)**, to populate their security association databases (SADs). These are then used for the actual exchange of secured datagrams with the AH and ESP protocols.

IKE is considered a “hybrid” protocol because it combines (and supplements) the functions of three other protocols. The first of these is the *Internet Security Association and Key Management Protocol (ISAKMP)*. This protocol provides a framework for exchanging encryption keys and security association information. It operates by allowing security associations to be negotiated through a series of phases.

ISAKMP is a generic protocol that supports many different key exchange methods. In IKE, the ISAKMP framework is used as the basis for a specific key exchange method that combines features from two key exchange protocols:

- ☉ **OAKLEY:** Describes a specific mechanism for exchanging keys through the definition of various key exchange “modes”. Most of the IKE key exchange process is based on OAKLEY.
- ☉ **SKEME:** Describes a different key exchange mechanism than OAKLEY. IKE uses some features from SKEME, including its method of public key encryption and its fast re-keying feature.

IKE Operation

So, IKE doesn't strictly implement either OAKLEY or SKEME but takes bits of each to form its own method of using ISAKMP. Clear as mud, I know. Since IKE functions within the framework of ISAKMP, its operation is based on the ISAKMP phased negotiation process. There are two phases:

- ☉ **ISAKMP Phase 1:** The first phase is a “setup” stage where two devices agree on how to exchange further information securely. This negotiation between the two units creates a security association for ISAKMP itself; an *ISAKMP SA*. This security association is then used for securely exchanging more detailed information in Phase 2.
- ☉ **ISAKMP Phase 2:** In this phase the ISAKMP SA established in Phase 1 is used to create SAs for other security protocols. Normally, this is where the parameters for the “real” SAs for the AH and ESP protocols would be negotiated.

An obvious question is why IKE bothers with this two-phased approach; why not just negotiate the security association for AH or ESP in the first place? Well, even though the extra phase adds overhead, multiple Phase 2 negotiations can be conducted after one Phase 1, which amortizes the extra “cost” of the two-phase approach. It is also possible to use a simpler exchange method for Phase 2 once the ISAKMP security association has been established in Phase 1.

The ISAKMP security association negotiated during Phase 1 includes the negotiation of the following attributes used for subsequent negotiations:

- ④ An encryption algorithm to be used, such as the *Data Encryption Standard (DES)*.
- ④ A hash algorithm (*MD5* or *SHA*, as used by AH or ESP).
- ④ An authentication method, such as authentication using previously shared keys.
- ④ A *Diffie-Hellman* group. Diffie and Hellman were two pioneers in the industry who invented public-key cryptography. In this method, instead of encrypting and decrypting with the same key, data is encrypted using a public key knowable to anyone, and decrypted using a private key that is kept secret. A Diffie-Hellman group defines the attributes of how to perform this type of cryptography. Four predefined groups derived from OAKLEY are specified in IKE and provision is allowed for defining new groups as well.

Note that even though security associations in general are unidirectional, the ISAKMP SA is established bidirectionally. Once Phase 1 is complete, then, either device can set up a subsequent SA for AH or ESP using it.



Internet Protocol Mobility Support (Mobile IP)

The [Internet Protocol \(IP\)](#) is the most successful network layer protocol in computing due to its many strengths, but it also has some weaknesses, most of which have become more important as networks have evolved over time. Technologies like [classless addressing](#) and [Network Address Translation](#) combat the exhaustion of the IPv4 address space, while IPSec provides it with secure communications it lacks. Another weakness of IP is that it was not designed with mobile computers in mind.

While mobile devices can certainly use IP, the way that devices are addressed and datagrams routed causes a problem when they are moved from one network to another. At the time IP was developed, computers were large and rarely moved. Today, we have millions of notebook computers and smaller devices, some of which even use wireless networking to connect to the wired network. The importance of providing full IP capabilities for these mobile devices has grown dramatically. To support IP in a mobile environment, a new protocol called *IP Mobility Support*, or more simply, *Mobile IP*, was developed.

In this section I describe the special protocol developed to overcome the problems with mobile computers attaching to IP internetworks. I begin with an overview of Mobile IP and a more detailed description of why it was created. I discuss important concepts that define Mobile IP and its general mode of operation. I then move on to some of the specifics of how Mobile IP works. This includes a description of the special mobile IP addressing scheme, an explanation of how agents are discovered by mobile devices, the process of registration with the device's home agent, and how data is encapsulated and routed. I discuss the impact that Mobile IP has on the operation of the TCP/IP Address Resolution Protocol (ARP). I end the section by examining some of the efficiency and security issues that come into play when Mobile IP is used.



Note: This section describes specifically how IP mobility support is provided for IPv4 networks. In the future I may add more specific details for how mobility is implemented in [IPv6](#).



Background Information: If you are not familiar with the basics of [IP addressing](#) and [routing](#), I strongly suggest at least skimming those sections before attempting to read about Mobile IP.

Mobile IP Overview, History and Motivation

Mobile computing has greatly increased in popularity over the past several years, due largely to advances in miniaturization. Today we can get in a notebook PC or even a hand-held computer the power that once required a hulking behemoth of a machine. We also have wireless LAN technologies that easily let a device move from place to place and retain networking connectivity at the data link layer. Unfortunately, the Internet Protocol was

developed back in the era of the behemoths, and isn't designed to deal gracefully with computers that move around. To understand why IP doesn't work well in a mobile environment, we must take a look back at how IP addressing and routing function.

The Problem With Mobile Nodes in TCP/IP

If you've read any of [the materials in this Guide on IP addressing](#)—and I certainly hope that you have—you know that IP addresses are [fundamentally divided into two portions](#): a network identifier (network ID) and a host identifier (host ID). The network ID specifies which network a host is on, and the host ID uniquely specifies hosts within a network. This structure is fundamental to datagram routing, because devices use the network ID portion of the destination address of a datagram to [determine if the recipient is on a local network or a remote one](#), and routers use it to determine how to route the datagram.

This is a great system, but it has one critical flaw: the IP address is tied tightly to the network where the device is located. Most devices never (or at least rarely) change their attachment point to the network, so this is not a problem, but it is certainly an issue for a mobile device. When the mobile device travels away from its home location, the system of routing based on IP address “breaks”. This is illustrated in [Figure 127](#).

Difficulties with Older Mobile Node Solutions

The tight binding of network identifier and host IP address means that there are only two real options under conventional IP when a mobile device moves from one network to another:

- ☉ **Change IP Address:** We can change the IP address of the host to a new address that includes the network ID of the network to which it is moving.
- ☉ **Decouple IP Routing From Address:** We can change the way routing is done for the device, so that instead of routers sending datagrams to it based on its network ID, they route based on its entire address.

These both seem like viable options at first glance, and if only a few devices tried them they might work. Unfortunately, they are both inefficient, often impractical, and neither is **scalable**, meaning, practical when thousands or millions of devices try them:

- ☉ Changing the IP address each time a device moves is time-consuming and normally requires manual intervention. In addition, the entire TCP/IP stack would need to be restarted, breaking any existing connections.
- ☉ If we change the mobile device's IP address, how do we communicate the change of address to other devices on the Internet? These devices will only have the mobile node's original home address, which means they won't be able to find it even if we give it a new address matching its new location.
- ☉ Routing based on the entire address of a host would mean the entire Internet would be flooded with routing information for each and every mobile computer. Considering how much trouble has gone into developing technologies like classless addressing to reduce routing table entries, it's obvious this is a Pandora's Box nobody wants to touch.

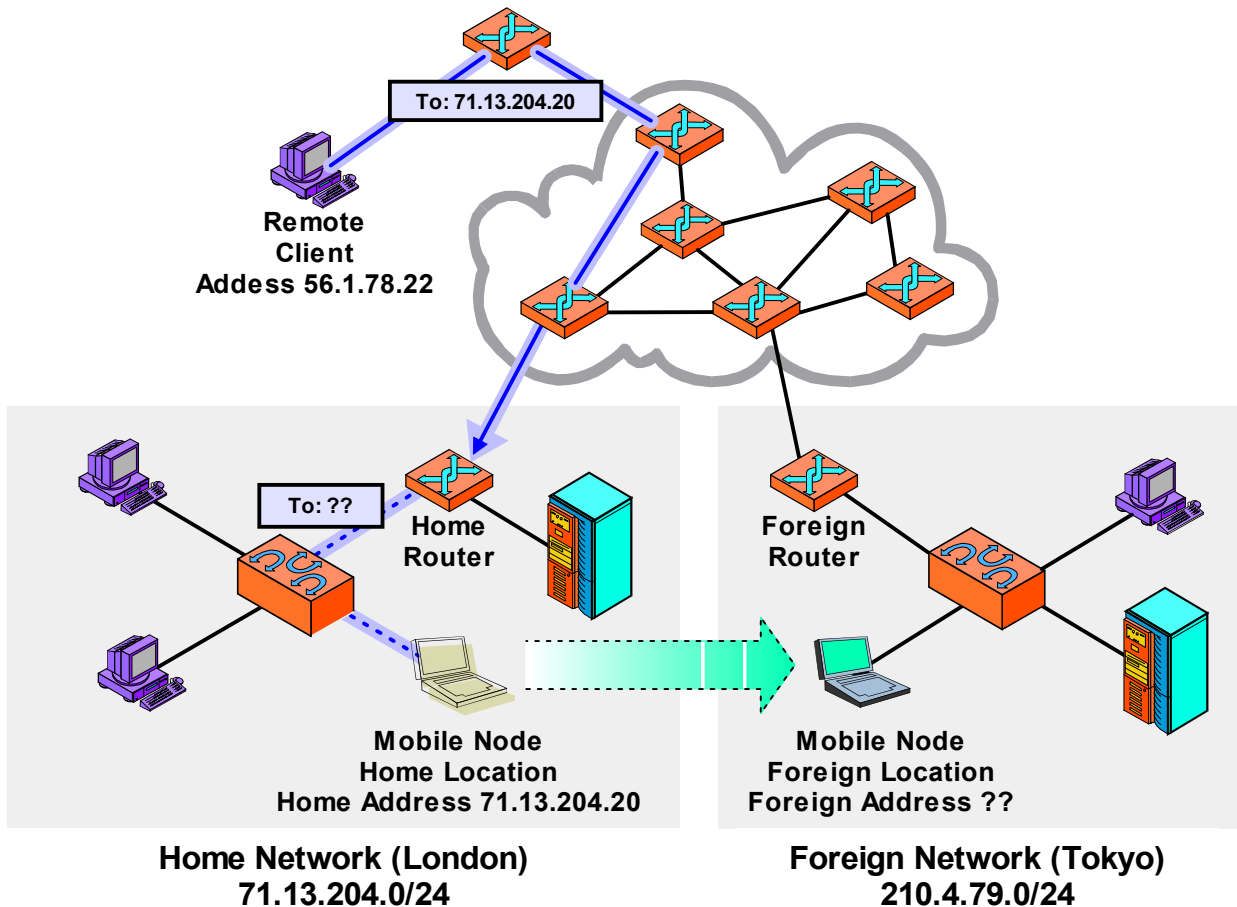

Figure 127: The Main Problem With Mobile Devices on IP Internetworks

In this example, a mobile device (the notebook PC) has been moved from its home network in London to another network in Tokyo. A remote client (upper left) decides to send a datagram to the mobile device.

However, it has no idea the device has moved. Since it sends using the mobile node's home address, 71.13.204.20, its request is routed to the router responsible for that network, which is in London. Of course the mobile device isn't there, so the router can't deliver it. Mobile IP solves this problem by giving mobile devices and routers the capability to forward datagrams from one location to another.



Key Concept: The basic problem with supporting mobile devices in IP internetworks is that routing is performed using the IP address, which means the IP address of a device is tied to the network where that device is located. If a device changes networks, data sent to its old address cannot be delivered by conventional means. Traditional workarounds such as routing by the full IP address or changing IP addresses manually often create more problems.

A Better Solution: Mobile IP

The solution to these difficulties was to define a new protocol especially to support mobile devices, which adds to the original Internet Protocol. This protocol, called *IP Mobility Support for IPv4*, was first defined in RFC 2002, updated in RFC 3220, and is now

described in RFC 3344. The formal name as given in that document title is rather long; the technology is more commonly called *Mobile IP* both in the RFC itself and by networking people.

To ensure its success, Mobile IP's designers had to meet a number of important goals. The resulting protocol has these key attributes and features:

- ① **Seamless Device Mobility Using Existing Device Address:** Mobile devices can change their physical network attachment method and location while continuing to use their existing IP address.
- ② **No New Addressing or Routing Requirements:** The overall scheme for addressing and routing as in regular IP is maintained. IP addresses are still assigned in the conventional way, by the owner of each device. No new routing requirements are placed on the internetwork, such as host-specific routes.
- ③ **Interoperability:** Mobile IP devices can still send to and receive from existing IP devices that do not know how Mobile IP works, and vice-versa.
- ④ **Layer Transparency:** The changes made by Mobile IP are confined to the network layer. Transport layer and higher layer protocols and applications are able to function as in regular IPv4, and existing connections can even be maintained across a move.
- ⑤ **Limited Hardware Changes:** Changes are required to the software in the mobile device, as well as to routers used directly by the mobile device. Other devices, however, do not need changes, including routers between the ones on the home and visited networks.
- ⑥ **Scalability:** Mobile IP allows a device to change from any network to any other, and supports this for an arbitrary number of devices. The scope of the connection change can be global; you could detach a notebook from an office in London and move it to Australia or Brazil, for example, and it will work the same as if you took it to the office next door.
- ⑦ **Security:** Mobile IP works by redirecting messages, and includes authentication procedures to prevent an unauthorized device from causing problems.

Mobile IP accomplishes these goals by implementing a *forwarding system* for mobile devices. When a mobile unit is on its “home” network, it functions normally. When it moves to a different network, datagrams are sent from its home network to its new location. This allows normal hosts and routers that don't know about Mobile IP to continue to operate as if the mobile device had not moved. Special support services are required to implement Mobile IP, to allow activities such as letting a mobile device determine where it is, telling the home network where to forward messages and more. I explore Mobile IP operation more in [the next topic](#), and the implementation specifics in the rest of this section.



Key Concept: *Mobile IP* solves the problems associated with devices that change network locations, by setting up a system where datagrams sent to the mobile node's home location are forwarded to it wherever it may be located. It is particularly useful for wireless devices but can be used for any device that moves between networks periodically.

Mobile IP is often associated with wireless networks, since devices using WLAN technology can move so easily from one network to another. However, it wasn't designed specifically for wireless. It can be equally useful for moving from an Ethernet network in one building to a network in another building, city or country. Mobile IP can be of great benefit in numerous applications, including traveling salespeople, consultants who visit client sites, administrators that walk around a campus troubleshooting problems, and much more.

Limitations of Mobile IP

It's important to realize that Mobile IP has certain limitations in its usefulness in a wireless environment. It was designed to handle mobility of devices, but only relatively *infrequent* mobility. This is due to the work involved with each change. This overhead isn't a big deal when you move a computer once a week, a day or even an hour. It can be an issue for "real-time" mobility such as roaming in a wireless network, where hand-off functions operating at the data link layer may be more suitable. Mobile IP was designed under the specific assumption that the attachment point would not change more than once per second.

I should also point out that Mobile IP is intended to be used with devices that maintain a static IP configuration. Since the device needs to be able to always know the identity of its home network and normal IP address, it is much more difficult to use it with a device that obtains an IP address dynamically, using something like DHCP.

Mobile IP Concepts and General Operation

I like analogies, as they provide a way of explaining often dry technical concepts in terms we can all relate to. The problem of mobile devices in an IP internetwork can easily be compared to a real-life mobility and information transmission problem: mail delivery for those who travel. To help explain how Mobile IP works, I will set up this analogy and use it as the basis for a look at Mobile IP's general operation. I will also refer back to it in explaining certain concepts in the remaining topics in this section.

Mobile IP Overview: "Address Forwarding" for the Internet

Suppose you are a consultant working for a large corporation with many offices. Your home office is in London, England, and you spend about half your time there. The rest of the time is split between other offices in say, Rome, Tokyo, New York City and Toronto. You also occasionally visit client sites that can be just about anywhere in the world. You may be at these remote locations for weeks at a time.

The problem is: how do you arrange things so that you can receive your mail regardless of your location? You have the same problem that regular IP has with a mobile device, and without taking special steps, the same two unsatisfactory options for resolving it: address changing or decoupling routing from your address. You can't change your address each time you move because you would be modifying it constantly; by the time you told everyone about your new address it would change again. And you certainly can't "decouple" the routing of mail from your address, unless you want to set up your own postal system!

The solution to this dilemma of course is *mail forwarding*. Let's say that you leave London for Tokyo for a couple of months. You tell the London post office (PO) that you will be in Tokyo. They intercept mail headed for your normal London address, relabel it, and forward it to Tokyo. Depending on where you are staying, this mail might be redirected either straight to a new address in Tokyo, or to a Tokyo PO where you can pick it up. If you leave Tokyo to go to another city, you just call the London PO and tell them your new location. When you come home, you cancel the forwarding and get your mail as always. (Yes, I'm assuming London and Tokyo each have only one post office. You mean they don't? Yeah, whatever. ☺)

The advantages of this system are many. It is relatively simple to understand and implement. It is also transparent to everyone who sends you mail; they still send to you in London and it gets wherever it needs to go. And handling of the forwarding mechanism is done only by the London PO and possibly the PO where you are presently located; the rest of the postal system doesn't even know anything out of the ordinary is going on.

There are some disadvantages of course too. The London PO may allow occasional forwarding for free, but would probably charge you if you did this on a regular basis. You might also need a special arrangement in the city you travel to. You have to keep communicating with your home PO each time you move. And perhaps most importantly, every piece of mail has to be sent through the system twice—first to London and then to wherever you are located—which is inefficient.

Mobile IP works in a manner very similar to the mail forwarding system I just described. The “traveling consultant” is the device that goes from network to network. Each network can be considered like a different “city”, and the internetwork of routers is like the postal system. The router that connects any network to the Internet is like that network's “post office”, from an IP perspective.

The mobile node is normally resident on its home network, which is the one that is indicated by the network ID in its IP address. Devices on the internetwork always route using this address, so the pieces of “mail” (datagrams) always arrive at a router at the device's “home”. When the device “travels” to another network, the home router (“post office”) intercepts these datagrams and forwards them to the device's current address. It may send them straight to the device using a new, temporary address, or it may send them to a router on the device's current network (the “other post office”, Tokyo in our analogy) for final delivery. An overview of Mobile IP operation can be seen in [Figure 128](#).

Mobile IP Device Roles

As you can see, just as mail forwarding requires support from one or more post offices, Mobile IP requires the help of two routers. In fact, special names are given to the three main players that implement the protocol (also shown in [Figure 128](#)):

- ☉ **Mobile Node:** This is the mobile device, the one moving around the internetwork.
- ☉ **Home Agent:** This is a router on the home network that is responsible for catching datagrams intended for the mobile node and forwarding them to it when it is traveling. It also implements other support functions necessary to run the protocol.

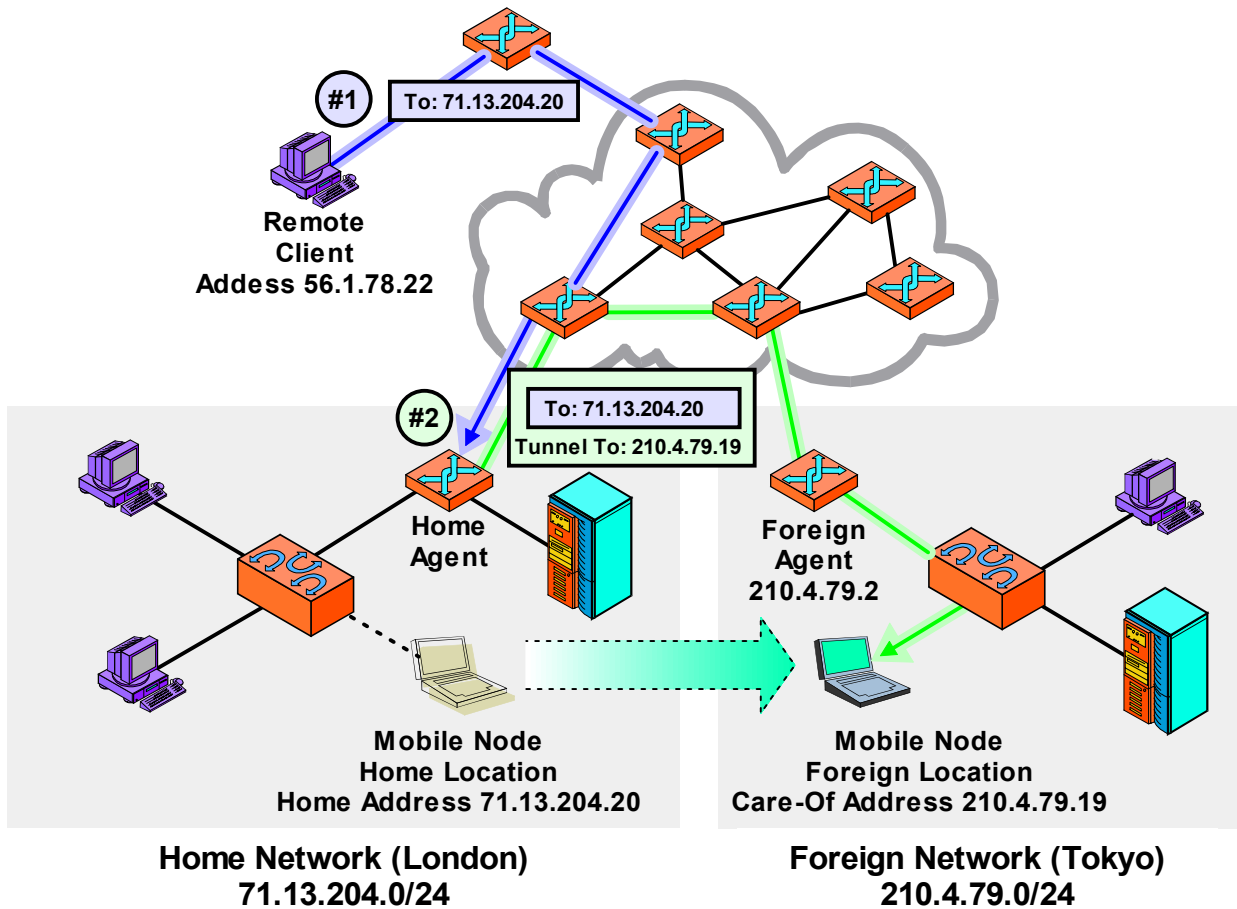

Figure 128: General Operation of the Mobile IP Protocol

This diagram is like [Figure 127](#), but with Mobile IP implemented. The mobile node's home router serves as home agent and the router in Tokyo as the foreign agent. The mobile has been assigned a temporary, "care-of" address to use while in Tokyo (which in this case is a *co-located* care-of address, meaning that it is assigned directly to the mobile node; [Figure 129](#) shows the same example using the other type of care-of address). In step #1, the remote client sends a datagram to the mobile using its home address, as before. It arrives in London as usual. In step #2, the home agent encapsulates that datagram in a new one and sends it to the mobile node in Tokyo.

- Foreign Agent:** This is a router on the network to which the mobile node is currently attached. It serves as a "home away from home" for the mobile node, normally acting as its default router as well as implementing Mobile IP functions. Depending on the mode of operation, it may receive forwarded datagrams from the home agent and forward them to the mobile node. It also supports the sharing of mobility information to make Mobile IP operate. The foreign agent may not be required in some Mobile IP implementations but is usually considered part of how the protocol operates.



Key Concept: Mobile IP operates by setting up the TCP/IP equivalent of a mail forwarding system. A router on a *mobile node*'s home network serves as the mobile device's *home agent*, and one on its current network acts as the *foreign agent*. The home agent receives datagrams destined for the mobile's normal IP address and forwards them to the mobile node's current location, either directly or by sending to the foreign agent. The home agent and foreign agent are also responsible for various communication and setup activities that are required for Mobile IP to work.

Mobile IP Functions

An important difference between Mobile IP and our mail forwarding example is one that represents the classic distinction between people and computers: people are smart and computers are not. When our consultant is traveling in Tokyo, he always knows he's in Tokyo and that his mail is being forwarded. (Well, assuming he goes easy on the sake, but that's a different story. ☺) He knows to go deal with the Tokyo post office to get his mail. The post office in London knows what forwarding is all about and how to do it. The traveler and the post offices all can communicate easily using the telephone.

In contrast, in the computer world, when a device travels using Mobile IP, things are more complicated. Suppose our consultant flies to Tokyo, turns on his notebook and plugs it in to the network. When the notebook is first turned on, it has no clue what is going on. It has to figure out that it is in Tokyo. It needs to find a foreign agent in Tokyo. It needs to know what address to use while in Tokyo. It needs to communicate back with its home agent back in London to tell it that it is in Tokyo and to start forwarding datagrams. Furthermore, it must accomplish its communication without any "telephone".

To this end, Mobile IP includes a host of special functions that are used to set up and manage datagram forwarding. To see how these support functions work, we can describe the general operation of Mobile IP as a simplified series of steps:

1. **Agent Communication:** The mobile node finds an agent on its local network by engaging in the *Agent Discovery* process. It listens for *Agent Advertisement* messages sent out by agents and from this can determine where it is located. If it doesn't hear these messages it can ask for one using an *Agent Solicitation* message.
2. **Network Location Determination:** The mobile node determines whether it is on its home network or a foreign one by looking at the information in the *Agent Advertisement* message.

If it is on its home network it functions using regular IP. To show how the rest of the process works, let's say the device sees that it just moved to a foreign network. The remaining steps are:

3. **Care-Of Address Acquisition:** The device obtains a temporary address called a *care-of address*. This either comes from the *Agent Advertisement* message from the foreign agent, or through some other means. This address is used only as the destination point for forwarding datagrams, and for no other purpose.

-
4. **Agent Registration:** The mobile node informs the home agent on its home network of its presence on the foreign network and enables datagram forwarding, by *registering* with the home agent. This may be done either directly between the node and the home agent, or indirectly using the foreign agent as a conduit.
 5. **Datagram Forwarding:** The home agent captures datagrams intended for the mobile node and forwards them. It may send them either directly to the node or indirectly to the foreign agent for delivery, depending on the type of care-of address in use.

Datagram forwarding continues until the current agent registration expires. The device can then renew it. If it moves again, it repeats the process to get a new care-of address and then registers its new location with the home agent. When the mobile node returns back to its home network, it *deregisters* to cancel datagram forwarding and resumes normal IP operation.

The following topics look in more detail at the functions summarized in each of the steps above.

Mobile IP Addressing: Home and "Care-Of" Addresses

Just as most of us have only a single address used for our mail, most IP devices have only a single address. Our traveling consultant, however, needs to have two addresses; a normal one and one that is used while he is away. Continuing our [earlier analogy](#), the Mobile-IP-equipped notebook our consultant carries needs to have two addresses as well:

- ☉ **Home Address:** The “normal”, permanent IP address assigned to the mobile node. This is the address used by the device on its home network, and the one to which datagrams intended for the mobile node are always sent.
- ☉ **Care-Of Address:** A secondary, temporary address used by a mobile node while it is “traveling” away from its home network. It is a normal 32-bit IP address in most respects, but is used only by Mobile IP for forwarding IP datagrams and for administrative functions. Higher layers never use it, nor do regular IP devices when creating datagrams.

Mobile IP Care-Of Address Types

The care-of address is a slightly tricky concept. There are two different types, which correspond to two distinctly different methods of forwarding datagrams from the home agent router.

Foreign Agent Care-Of Address

This is a care-of address provided by a foreign agent in its *Agent Advertisement* message. It is, in fact, the IP address of the foreign agent itself. When this type of care-of address is used, all datagrams captured by the home agent are not relayed directly to the mobile node, but indirectly to the foreign agent, which is responsible for final delivery. Since in this arrangement the mobile node has no distinct IP address valid on the foreign network, this is typically done using a layer two technology. This arrangement is illustrated in [Figure 129](#).

In our consultant analogy, this type of care-of address is like forwarding from the London post office to the Tokyo post office. The London personnel would take a letter for John Smith sent to his London address, and repackage it for delivery to “John Smith, care of the Tokyo post office”. The Tokyo post office (or John Smith himself) would need to worry about the last leg of the delivery.

Co-Located Care-Of Address

This is a care-of address assigned directly to the mobile node using some means external to Mobile IP. For example, it may be assigned on the foreign network manually, or automatically using [DHCP](#). In this situation, the care-of address is used to forward traffic from the home agent directly to the mobile node. This was the type of address shown in [Figure 128](#).

In our consultant analogy, this is like John Smith obtaining a temporary address for his use while in Tokyo. The London post office would forward directly to his Tokyo address. They would not specifically send it to the Tokyo post office (though of course that PO would handle the mail at some point).



Key Concept: In Mobile IP, each mobile device uses a temporary, *care-of address* while on a foreign network. A *co-located* care-of address is one that is assigned directly to the mobile node, and enables direct delivery of datagrams to the node. The alternative is to use a *foreign agent* care-of address. In this situation the mobile node actually uses the IP address of the foreign agent; datagrams are sent to the foreign agent, which delivers them to the mobile node.

Advantages and Disadvantages of the Care-Of Address Types

The foreign agent care-of address is considered the type used in “classical” Mobile IP, where there is both a home agent and a foreign agent. While it seems less efficient than the co-located address method, it offers some important advantages. A key one is that the same foreign agent care-of address can be used for all mobile nodes visiting that network. Datagrams for all mobile nodes on that network are sent to the foreign agent, which completes the delivery to the individual nodes. Since the mobile nodes use the foreign agent's address, no extra addresses or extra work are required for each mobile node.

The co-located care-of address has the advantage that traffic can be forwarded directly from the home agent to the mobile node. In this type of arrangement, it is possible for a Mobile IP device to travel to a foreign network where there is no Mobile-IP-aware router to act as a foreign agent. This does mean, however, that the Mobile IP implementation must include all the functions of communicating with the home agent that the foreign agent normally performs.

When co-located care-of addresses are used, an issue is how the temporary address is obtained. In many foreign networks automatic assignment of an IP address using something like DHCP may be possible, but if not, a temporary IP address would need to be

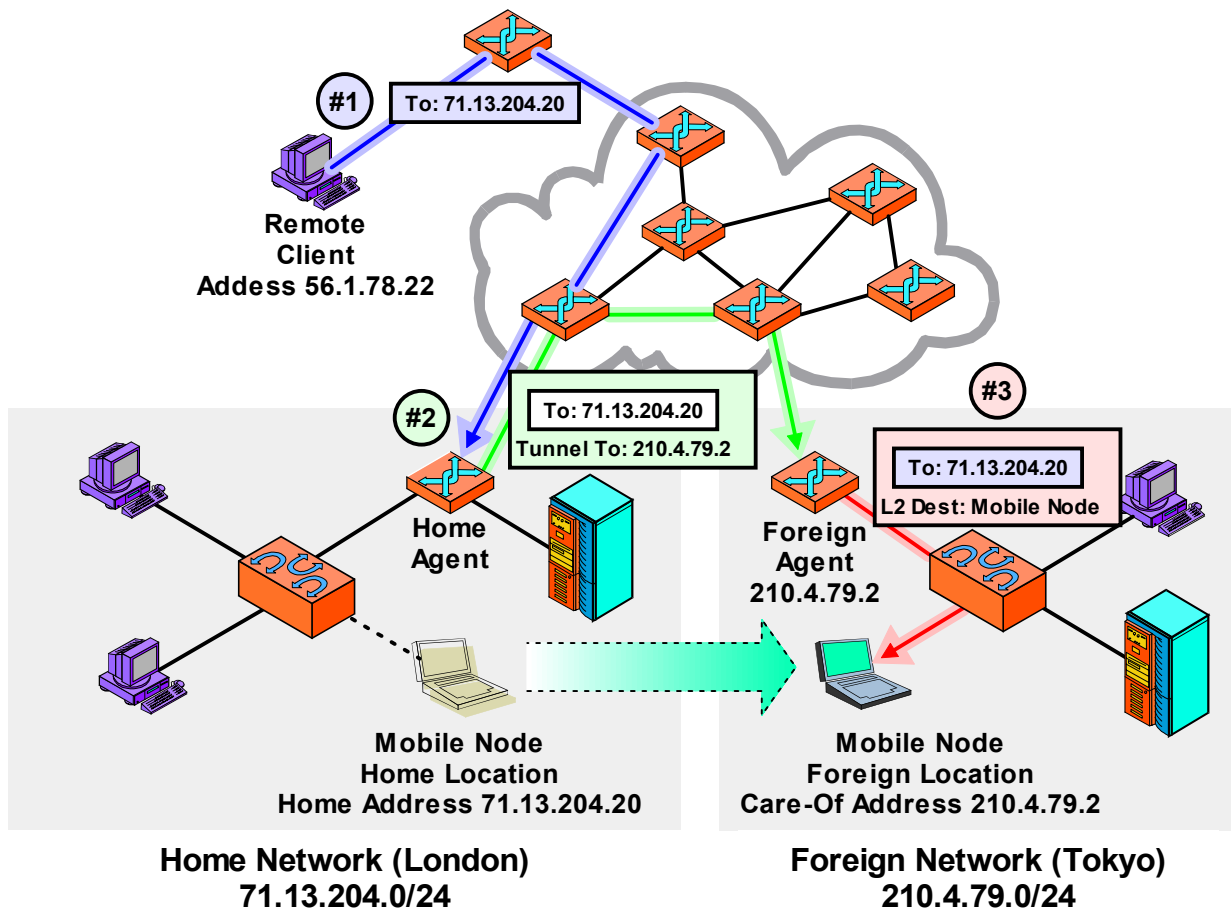

Figure 129: Mobile IP Operation With A Foreign Agent “Care-Of” Address

This diagram is similar to [Figure 128](#), except that instead of the mobile node having a co-located (distinct) IP address as in that example, here the mobile node is using a foreign agent care-of address. This means that the node’s care-of address is actually that of the foreign agent itself. Step #1 is the same as in [Figure 128](#), but in step #2 the home agent forwards not to the mobile node directly, but to the foreign agent (since that router is the one whose IP address the mobile is using). In step #3 the foreign agent strips off the home agent’s packaging and delivers the original datagram to the mobile node. This is typically done using whatever layer two (LAN or wireless LAN) technology connects the mobile node and foreign agent together.

assigned. Either way, some of the foreign network’s limited IP address space would need to be set aside for mobile nodes, each of which would use an address while present on the network. In some cases this could lead to an address depletion issue.

Foreign agent care-of addressing is usually preferred due to its more automatic nature, when a foreign agent is present on the visited network. Considering that all datagrams will need to go through some router on the foreign network to reach the mobile node anyway, we might as well save the extra IP addresses. Co-located care-of addresses would be used when there is no foreign agent, or might be practical for long term connections even when a foreign agent is present.

Remember that the care-of address represents only the destination to which mobile node datagrams are forwarded. Foreign agents provide services other than forwarding, so it is possible for a mobile node to use a co-located care-of address even when a foreign agent is present, while continuing to take advantage of the other foreign agent services.



Key Concept: In Mobile IP, co-located care-of addresses have the advantage of flexibility, but require each device to have a unique IP address on the remote network. Foreign agent care-of addresses have the chief advantage of allowing many mobile devices on a foreign network without each requiring a distinct IP address.

For more information on how datagrams are forwarded between the home agent and the mobile node's care-of address, see [the topic on Mobile IP encapsulation and tunneling](#).

Mobile IP Agent Discovery, and Agent Advertisement and Solicitation Messages

When a mobile node is first turned on, it cannot assume that it is still “at home” the way normal IP devices do. It must first determine where it is, and if it is not at home, begin the process of setting up datagram forwarding from its home network. This process is accomplished by communicating with a local router serving as an agent, through the process called *agent discovery*.

Agent Discovery Process

Agent discovery encompasses the first three steps in the simplified five-step Mobile IP operational summary I gave in [the topic on general operation](#). The main goals of agent discovery include the following:

- ① **Agent/Node Communication:** Agent discovery is the method by which a mobile node first establishes contact with an agent on the local network to which it is attached. Messages are sent from the agent to the node containing important information about the agent; a message can also be sent from the node to the agent asking for this information to be sent.
- ② **Orientation:** The node uses the agent discovery process to determine where it is. Specifically, it learns whether it is on its home network or a foreign network by identifying the agent that sends it messages.
- ③ **Care-Of Address Assignment:** The agent discovery process is the method used to tell a mobile node the [care-of address](#) it should use, when foreign agent care-of addressing is used.

Mobile IP agents are routers that have been given additional programming to make them “Mobile IP aware”. The communication between a mobile node and the agent on its local network is basically the same as the normal communication required between a device on an IP network and its local router, except more information needs to be sent when the router is an agent.

Agent Advertisement and Agent Solicitation Messages

Provision already exists for exchanges of data between a router and a node, in the form of ICMP messages that are used for the regular IP *router discovery* process. Two messages are used for this purpose: *Router Advertisement* messages that let routers tell local nodes that they exist and describe their capabilities, and *Router Solicitation* messages that let a node prompt a router to send an advertisement. [These are described in their own topic in the ICMP section.](#)

Given the similarity to normal router discovery, it made sense to implement agent discovery as a modification to the existing process rather than set up a whole new system. The messages used in the agent discovery process are:

- ☉ **Agent Advertisement:** This is a message transmitted regularly by a router acting as a Mobile IP agent. It consists of a regular *Router Advertisement* message that has one or more *extensions* added that contain Mobile-IP-specific information for mobile nodes.
- ☉ **Agent Solicitation:** This message can be sent by a mobile IP device to nudge a local agent to send an *Agent Advertisement*.

The use of these messages is described in the Mobile IP standard in detail, and unsurprisingly, is very similar to how regular *Router Advertisement* and *Router Solicitation* messages are employed. Agents are normally configured to send out *Agent Advertisements* on a regular basis, with the rate set to ensure reasonably fast contact with mobile nodes without consuming excessive network bandwidth. They are required to respond to any *Agent Solicitation* messages they receive by sending an *Advertisement*. It is possible that some agents may be configured to send *Advertisements* only upon receipt of a *Solicitation*.

Mobile nodes are required to accept and process *Agent Advertisements*. They distinguish these from regular *Router Advertisements* by looking at the size of the message. They then parse the extension(s) to learn the capabilities of the local agent. They determine whether they are on their home network or a foreign network, and in the case of a foreign agent, how the agent should be used. Mobile nodes are required to use *Agent Advertisements* to detect when they have moved, using one of two algorithms defined in the standard, and also to detect when they have returned back to their home network after they have been traveling. They are also required to be able to send *Agent Solicitation* messages if they don't receive an *Agent Advertisement* after a certain period of time. They are restricted to sending these only infrequently, however, again to keep traffic manageable.

Now let's look at the formats of the two message types.

Agent Solicitation Message Format

Let's start with the *Agent Solicitation* message because it is much simpler. In fact, there is no new message format defined for this at all; it is identical to the format of a [Router Solicitation message](#).

The reason no new message type is required here is that a solicitation is an extremely simple message: “hey, if there are any routers out there, please tell me who you are and what you can do”. No extra Mobile IP information needs to be sent. When a regular IP router receives a *Router Solicitation* it will send a *Router Advertisement*, but a Mobile IP router automatically sends the longer *Agent Advertisement* instead when prompted by any solicitation, whether it comes from a Mobile IP node or a regular IP device.

Agent Advertisement Message Format

The *Agent Advertisement* begins with the normal fields of an [ICMP Router Advertisement message](#). The destination of the message is either the “[all devices](#)” multicast address (224.0.0.1) if multicast is supported on the local network, or the broadcast address (255.255.255.255) otherwise. The *Router Address* fields are filled in with the address(es) of the agent.



Note: It is possible that a device may wish to advertise its ability to handle Mobile IP messages, but not act as a regular router. In this case it changes the normal *Code* field in the header of the *Router Advertisement* message from 0 to 16.

Following the regular fields, one or more *extensions* are added to the message format. There are three extensions defined: the *Mobility Agent Advertisement Extension*, *Prefix-Lengths Extension*, and *One-Byte Padding Extension*.

Mobility Agent Advertisement Extension

This is the main extension used to convey Mobile IP capabilities of the agent to mobile nodes on the local network. It contains numerous fields used as part of the various processes described in this overall section on Mobile IP.

The structure of the *Mobility Agent Advertisement Extension* is described in [Table 82](#) and shown graphically in [Figure 130](#).

Table 82: Mobile IP *Mobility Agent Advertisement Extension* Format

Field Name	Size (bytes)	Description																											
Type	1	Extension Type: Identifies the <i>Agent Advertisement</i> extension type. For the <i>Mobility Agent Advertisement Extension</i> , it is set to 16.																											
Length	1	Length: Length of the extension in bytes, excluding the <i>Type</i> and <i>Length</i> fields. Thus, it is equal to 6 plus 4 for each care-of address in the message.																											
Sequence Number	2	Sequence Number: A sequential counter set to zero when the router initializes and then incremented for each advertisement sent out.																											
Registration Lifetime	2	Registration Lifetime: The maximum length of time, in seconds, the agent is willing to accept for registration requests . A value of 65,535 (all ones) means "infinite". Note that this field is for registration only and has no relation to the regular Lifetime field in the regular Router Advertisement part of the message.																											
Flags	1	<p>Flags: A one-byte field containing several informational flags that convey specific information about the agent's capabilities and status. There are seven one-bit flags, which when set to one convey the meanings given in the table below:</p> <table border="1"> <thead> <tr> <th>Subfield Name</th> <th>Size (bytes)</th> <th>Description</th> </tr> </thead> <tbody> <tr> <td>R</td> <td>1/8 (1 bit)</td> <td>Registration Required: The mobile node must register through the foreign agent, even when using a co-located care-of address.</td> </tr> <tr> <td>B</td> <td>1/8 (1 bit)</td> <td>Busy: The agent is currently too busy to accept further registrations from mobile nodes.</td> </tr> <tr> <td>H</td> <td>1/8 (1 bit)</td> <td>Home Agent: The agent is willing to function as a home agent on this link (it will forward datagrams, etc.) Note that a device can offer services as both a home agent and a foreign agent.</td> </tr> <tr> <td>F</td> <td>1/8 (1 bit)</td> <td>Foreign Agent: The agent is willing to function as a foreign agent. Again, a device can act as both a home agent and a foreign agent simultaneously.</td> </tr> <tr> <td>M</td> <td>1/8 (1 bit)</td> <td>Minimal Encapsulation: The agent can receive tunneled datagrams using minimal encapsulation.</td> </tr> <tr> <td>G</td> <td>1/8 (1 bit)</td> <td>GRE Encapsulation: The agent can receive tunneled datagrams using GRE encapsulation.</td> </tr> <tr> <td>r</td> <td>1/8 (1 bit)</td> <td>Reserved: Not used; sent as zero.</td> </tr> <tr> <td>T</td> <td>1/8 (1 bit)</td> <td>Reverse Tunneling: The agent supports reverse tunneling.</td> </tr> </tbody> </table>	Subfield Name	Size (bytes)	Description	R	1/8 (1 bit)	Registration Required: The mobile node must register through the foreign agent, even when using a co-located care-of address.	B	1/8 (1 bit)	Busy: The agent is currently too busy to accept further registrations from mobile nodes.	H	1/8 (1 bit)	Home Agent: The agent is willing to function as a home agent on this link (it will forward datagrams, etc.) Note that a device can offer services as both a home agent and a foreign agent.	F	1/8 (1 bit)	Foreign Agent: The agent is willing to function as a foreign agent. Again, a device can act as both a home agent and a foreign agent simultaneously.	M	1/8 (1 bit)	Minimal Encapsulation: The agent can receive tunneled datagrams using minimal encapsulation.	G	1/8 (1 bit)	GRE Encapsulation: The agent can receive tunneled datagrams using GRE encapsulation.	r	1/8 (1 bit)	Reserved: Not used; sent as zero.	T	1/8 (1 bit)	Reverse Tunneling: The agent supports reverse tunneling.
Subfield Name	Size (bytes)	Description																											
R	1/8 (1 bit)	Registration Required: The mobile node must register through the foreign agent, even when using a co-located care-of address.																											
B	1/8 (1 bit)	Busy: The agent is currently too busy to accept further registrations from mobile nodes.																											
H	1/8 (1 bit)	Home Agent: The agent is willing to function as a home agent on this link (it will forward datagrams, etc.) Note that a device can offer services as both a home agent and a foreign agent.																											
F	1/8 (1 bit)	Foreign Agent: The agent is willing to function as a foreign agent. Again, a device can act as both a home agent and a foreign agent simultaneously.																											
M	1/8 (1 bit)	Minimal Encapsulation: The agent can receive tunneled datagrams using minimal encapsulation.																											
G	1/8 (1 bit)	GRE Encapsulation: The agent can receive tunneled datagrams using GRE encapsulation.																											
r	1/8 (1 bit)	Reserved: Not used; sent as zero.																											
T	1/8 (1 bit)	Reverse Tunneling: The agent supports reverse tunneling.																											
Reserved	1	Reserved: Sent as zero and ignored by recipient.																											
Care-Of Addresses	Variable (4 per address)	Care-Of Addresses: Zero or more addresses provided by a foreign agent for a mobile node to use as a foreign agent care-of address. A foreign agent must always provide at least one address in its advertisement; a router that cannot act as a foreign agent will typically omit this field.																											

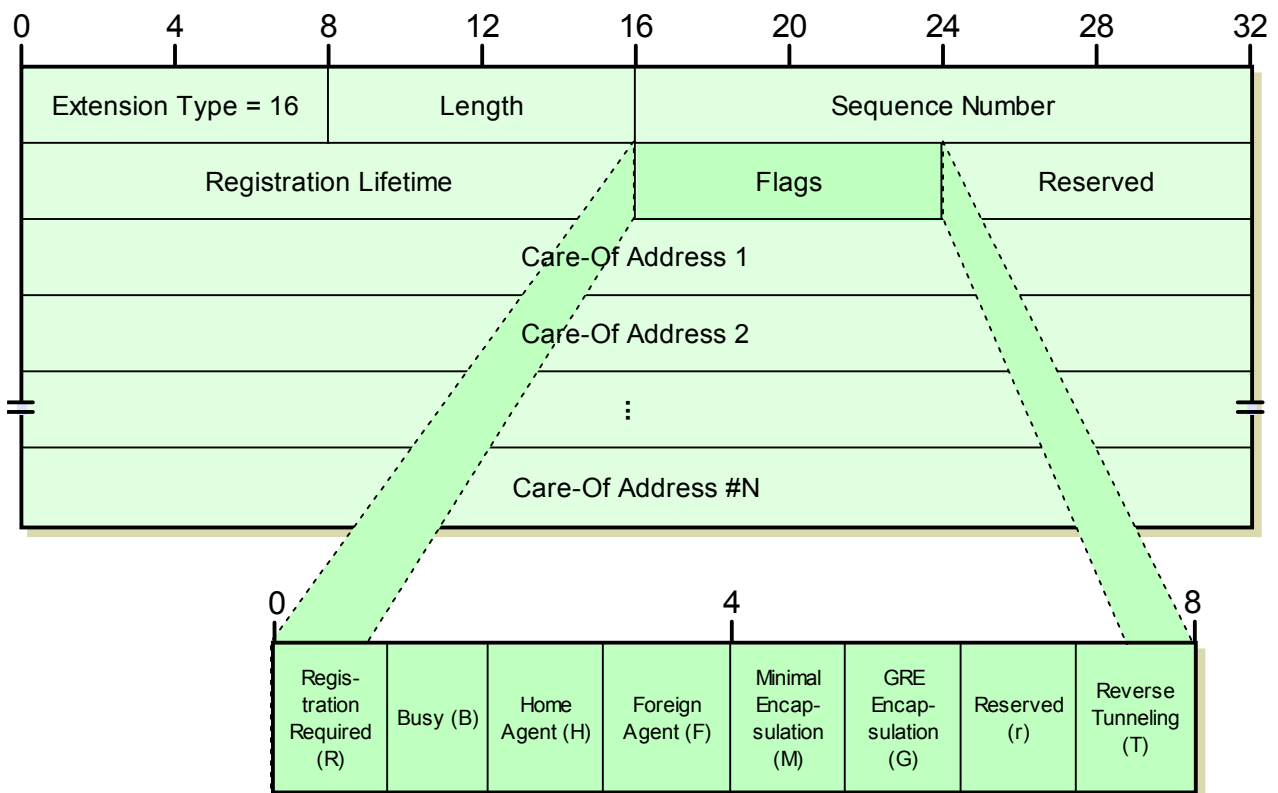

Figure 130: Mobile IP *Mobility Agent Advertisement* Extension Format

This extension appears after the normal fields of a *Router Advertisement* message, as shown in [Figure 148](#).



Related Information: See [the topic on Mobile IP encapsulation](#) for more on minimal and GRE encapsulation and reverse tunneling.

Prefix-Lengths Extension

This is an optional extension that tells a mobile node the prefix length(s) of the router address(es) contained in the regular portion of the *Agent Advertisement* message; that is, the *Router Address* field in the regular *Router Advertisement* part of the message. The [prefix length](#) is another term for the number of bits in an IP address is the network ID, so this tells the node the network ID in each of the router's addresses

The format of the *Prefix-Lengths Extension* is shown in [Table 83](#) and also in [Figure 131](#).

Table 83: Mobile IP *Prefix-Lengths Extension* Format

Field Name	Size (bytes)	Description
<i>Type</i>	1	Extension Type: Identifies the <i>Agent Advertisement</i> extension type. For the <i>Prefix-Lengths Extension</i> , it is set to 19.
<i>Length</i>	1	Length: Length of the extension in bytes, excluding the <i>Type</i> and <i>Length</i> fields. Thus, it is equal to the number of prefix lengths (since each takes 1 byte).
<i>Prefix Lengths</i>	Variable (1 per length)	Prefix Lengths: One prefix length number for each router address in the regular, <i>Router Advertisement</i> portion of the <i>Agent Advertisement</i> .

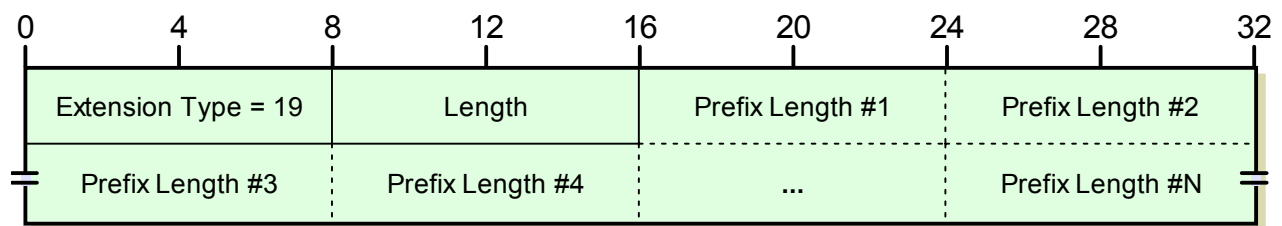

Figure 131: Mobile IP *Prefix-Lengths Extension* Format

This extension appears after the normal fields of a *Router Advertisement* message, as shown in [Figure 148](#).

One-Byte Padding Extension

Some implementations require ICMP messages to be an even number of bytes, so a byte of padding is needed. (The *One-Byte Padding Extension* is just a single byte of all zeroes. No tables or figures needed for that!)



Key Concept: Mobile IP *agent discovery* is the process by which a mobile node determines where it is located and establishes contact with a home or foreign agent. Routers that can function as agents regularly send *Agent Advertisement* messages to indicate their capabilities, which are modified versions of regular *Router Advertisements*. A mobile node can also send an *Agent Solicitation* to request the sending of an *Advertisement*, which is the same as regular *Router Solicitation*.



Note: Mobile IP does not include any provisions for authentication of *Agent Advertisement* and *Agent Solicitation* messages. They may be authenticated using **IPSec**, of course, if that has been implemented.

Mobile IP Home Agent Registration and Registration Messages

Once a mobile node has completed [agent discovery](#), it knows whether it is on its home network or a foreign network. If on its home network it communicates as a regular IP device, but if on a foreign network it must activate Mobile IP. This requires that it communicate with its home agent so information and instructions can be exchanged between the two. This process is called *home agent registration*, or more simply, just *registration*.

The main purpose of registration is to actually start Mobile IP working. The mobile node must contact the home agent and tell it that it is on a foreign network and request that datagram forwarding be turned on. It also must let the home agent know its [care-of address](#) so the home agent knows where to send the forwarded datagrams. The home agent in turn needs to communicate various types of information back to the mobile node when registration is performed. Note that the foreign agent is not really involved in registration, except perhaps to relay messages, as we will see.

Mobile Node Registration Events

Successful registration establishes what is called in the standard a *mobility binding* between a home agent and a mobile node. For the duration of the registration, the mobile node's regular home address is tied to its current care-of address and the home agent will encapsulate and forward datagrams addressed to the home address over to the care-of address. The mobile node is supposed to manage its registration and handle various events using several actions:

- ☉ **Registration:** The mobile node initiates a registration when it first detects it has moved from its home network to a foreign network.
- ☉ **Deregistration:** When the mobile node returns home, it should tell the home agent to cancel forwarding, a process called *deregistration*.
- ☉ **Reregistration:** If the mobile node moves from one foreign network to another, or if its care-of address changes, it must update its registration with the home agent. It also must do so if its current registration is about to expire, even if it remains stationary on one foreign network.

Each registration is established only for a specific length of time, which is why regular reregistration is required whether the device moves or not. Registrations are time-limited to ensure that they do not become stale. If, for example, a node forgets to de-register when it returns home, the datagram forwarding will eventually stop when the registration expires.

New Registration Request and Registration Reply Messages

To perform registration, two new message types have been defined in Mobile IP: the *Registration Request* and the *Registration Reply*. Each of these does what you would expect from its name. Interestingly, these are not ICMP messages like the ones used in agent discovery; they are [User Datagram Protocol \(UDP\)](#) messages. Thus, technically speaking, registration is performed at a higher layer than the rest of Mobile IP communication. Agents listen for *Registration Requests* on well-known UDP port #434, and respond back to mobile nodes using whatever [ephemeral port](#) the node used to send the message.

The formats of these two messages are described later in this topic.

Registration Procedures

There are two different procedures defined for registration, depending on the type of care-of address used by the mobile node and other specifics we will get into shortly. The first is the direct registration method, which has just two steps:

1. Mobile node sends *Registration Request* to home agent.
2. Home agent sends *Registration Reply* back to mobile node.

In some cases, however, a slightly more complex process is required, where the foreign agent conveys messages between the home agent and the mobile node. In this situation, the process has four steps:

1. Mobile node sends *Registration Request* to foreign agent.
2. Foreign agent processes *Registration Request* and forwards to home agent.
3. Home agent sends *Registration Reply* to foreign agent.
4. Foreign agent processes *Registration Reply* and sends back to mobile node.

The first, simpler method is normally used when a mobile node is using a co-located care-of address. In that situation, the node can easily communicate directly with the home agent, and the mobile node is also set up to directly receive information and datagrams from the home agent. When there is no foreign agent, this is obviously the method that ***must*** be used. It is also obviously the method used when a mobile node is de-registering with its home agent after it arrives back on the home network.

The second method is required when a mobile node is using a foreign care-of address. Recall that in this situation, the mobile node doesn't have its own unique IP address at all; it is using a shared address given it by the foreign agent, which precludes direct communication between the node and the home agent. Also, if a mobile node receives an *Agent Advertisement* with the "R" flag set, it also should go through the foreign agent, even if it has a co-located care-of address.

Note that the foreign agent really is just a "middleman"; the exchange is still really between the home agent and the mobile node. However, the foreign agent can deny registration if the request violates whatever rules are in place for using the foreign network. It is for this reason that some foreign agents may require that they be the conduit for registrations even if the mobile node has a co-located care-of address. Of course, if the foreign agent can't contact the home agent the registration will not be able to proceed.

The description above is really a highly simplified explanation of the basics of registration. The Mobile IP standard specifies many more details on exactly how agents and nodes perform registration, including particulars on when requests and replies are sent, how to handle various special conditions such as invalid requests, rules for how home agents maintain a table of mobility bindings, and much more. The standard covers the definition of extensions to the regular registration messages to support authentication, which is required

for secure communications (see the topic on security issues for more details). It also includes the ability to have a mobile node maintain more than one concurrent binding, when needed.



Key Concept: Mobile IP *home agent registration* is the process by which a *mobility binding* is created between a home agent and a traveling mobile node to enable datagram forwarding to be performed. Registration is performed by the mobile node sending a *Registration Request* message, and the home agent returning a *Registration Reply*. The foreign agent may be required to act as a “middleman” to facilitate the transaction, but is otherwise not involved.

Registration Request Message Format

Registration Request messages have the format shown in Table 84 and Figure 132.

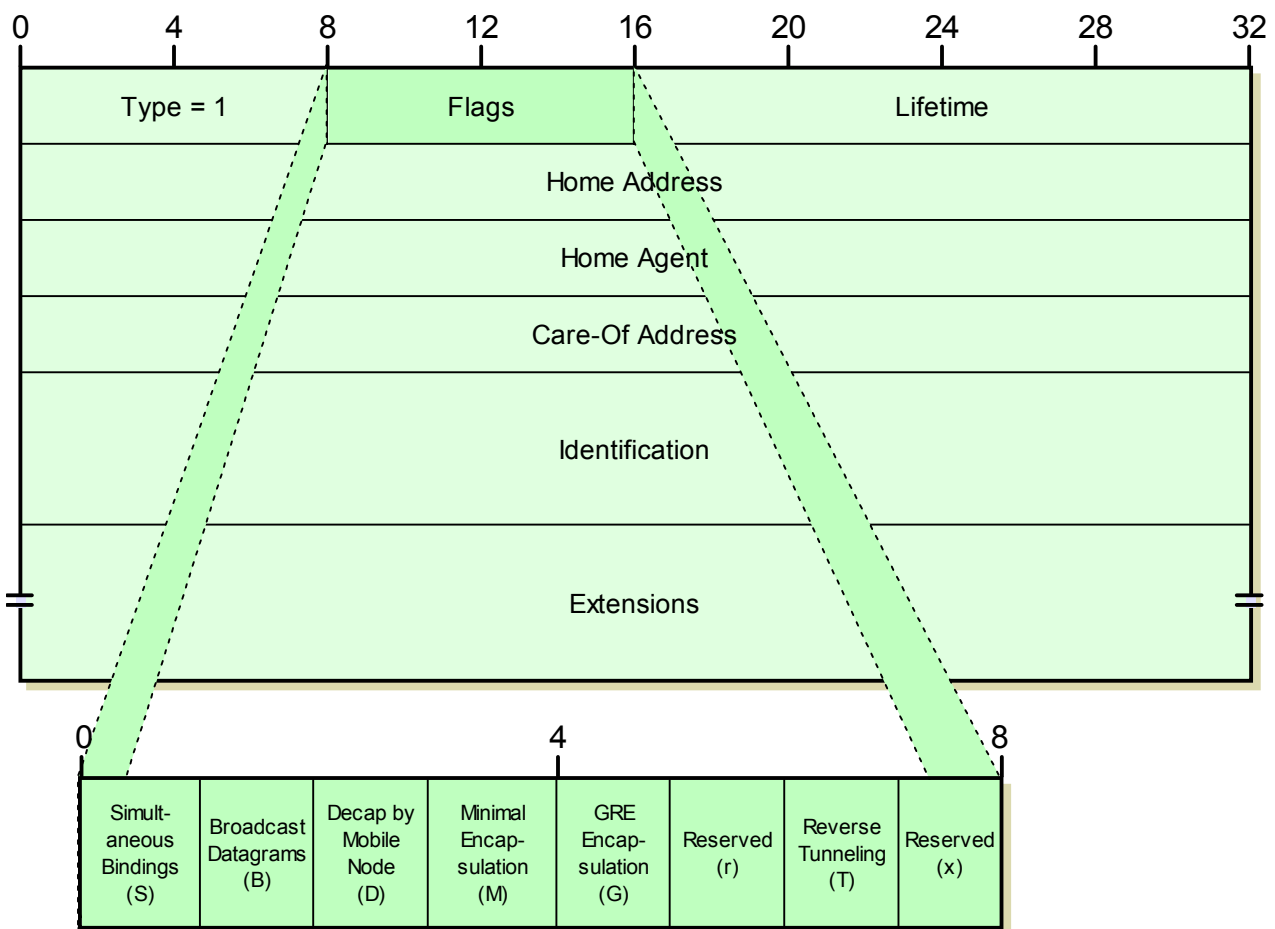

Figure 132: Mobile IP Registration Request Message Format

This message is carried in the payload of a User Datagram Protocol (UDP) message, the headers of which are not shown.

Table 84: Mobile IP Registration Request Message Format (Page 1 of 2)

Field Name	Size (bytes)	Description																											
Type	1	Type: Identifies the registration message type. For a request, this field is 1.																											
Flags	1	<p>Flags: A one-byte field containing several informational flags that convey specific requests being made by the mobile node to the home agent. When set, a flag conveys the meanings given in the appropriate entry below:</p> <table border="1"> <thead> <tr> <th>Subfield Name</th> <th>Size (bytes)</th> <th>Description</th> </tr> </thead> <tbody> <tr> <td>S</td> <td>1/8 (1 bit)</td> <td>Simultaneous Bindings: Mobile node requests that prior mobility bindings be retained in addition to the one in the current request.</td> </tr> <tr> <td>B</td> <td>1/8 (1 bit)</td> <td>Broadcast Datagrams: Mobile node requests that broadcasts on the home network be forwarded to it.</td> </tr> <tr> <td>D</td> <td>1/8 (1 bit)</td> <td>Decapsulation By Mobile Node: Mobile node is telling the home agent that it will itself decapsulate encapsulated datagrams, as opposed to a foreign agent. In other words, when this is one, the mobile node is using a co-located care-of address; when zero, it is using a foreign agent care-of address.</td> </tr> <tr> <td>M</td> <td>1/8 (1 bit)</td> <td>Minimal Encapsulation: Mobile node requests that home agent use minimal encapsulation for forwarded datagrams.</td> </tr> <tr> <td>G</td> <td>1/8 (1 bit)</td> <td>GRE Encapsulation: Mobile node requests that home agent use GRE encapsulation for forwarded datagrams.</td> </tr> <tr> <td>r</td> <td>1/8 (1 bit)</td> <td>Reserved: Not used; sent as zero.</td> </tr> <tr> <td>T</td> <td>1/8 (1 bit)</td> <td>Reverse Tunneling: Mobile node requests that reverse tunneling be used by the home agent.</td> </tr> <tr> <td>x</td> <td>1/8 (1 bit)</td> <td>Reserved: Not used; sent as zero.</td> </tr> </tbody> </table>	Subfield Name	Size (bytes)	Description	S	1/8 (1 bit)	Simultaneous Bindings: Mobile node requests that prior mobility bindings be retained in addition to the one in the current request.	B	1/8 (1 bit)	Broadcast Datagrams: Mobile node requests that broadcasts on the home network be forwarded to it.	D	1/8 (1 bit)	Decapsulation By Mobile Node: Mobile node is telling the home agent that it will itself decapsulate encapsulated datagrams, as opposed to a foreign agent. In other words, when this is one, the mobile node is using a co-located care-of address; when zero, it is using a foreign agent care-of address.	M	1/8 (1 bit)	Minimal Encapsulation: Mobile node requests that home agent use minimal encapsulation for forwarded datagrams.	G	1/8 (1 bit)	GRE Encapsulation: Mobile node requests that home agent use GRE encapsulation for forwarded datagrams.	r	1/8 (1 bit)	Reserved: Not used; sent as zero.	T	1/8 (1 bit)	Reverse Tunneling: Mobile node requests that reverse tunneling be used by the home agent.	x	1/8 (1 bit)	Reserved: Not used; sent as zero.
Subfield Name	Size (bytes)	Description																											
S	1/8 (1 bit)	Simultaneous Bindings: Mobile node requests that prior mobility bindings be retained in addition to the one in the current request.																											
B	1/8 (1 bit)	Broadcast Datagrams: Mobile node requests that broadcasts on the home network be forwarded to it.																											
D	1/8 (1 bit)	Decapsulation By Mobile Node: Mobile node is telling the home agent that it will itself decapsulate encapsulated datagrams, as opposed to a foreign agent. In other words, when this is one, the mobile node is using a co-located care-of address; when zero, it is using a foreign agent care-of address.																											
M	1/8 (1 bit)	Minimal Encapsulation: Mobile node requests that home agent use minimal encapsulation for forwarded datagrams.																											
G	1/8 (1 bit)	GRE Encapsulation: Mobile node requests that home agent use GRE encapsulation for forwarded datagrams.																											
r	1/8 (1 bit)	Reserved: Not used; sent as zero.																											
T	1/8 (1 bit)	Reverse Tunneling: Mobile node requests that reverse tunneling be used by the home agent.																											
x	1/8 (1 bit)	Reserved: Not used; sent as zero.																											
Lifetime	2	Lifetime: Length of time, in seconds, that the mobile node requests from the home agent for this registration.																											
Home Address	4	Home Address: The home (normal) IP address of the mobile node when on its home network. Uniquely identifies the device regardless of how the request is conveyed to the home agent.																											
Home Agent	4	Home Agent: The IP address of the device acting as the mobile node's home agent.																											
Care-Of Address	4	Care-Of Address: The IP address being used by the mobile node as its care-of address.																											

Table 84: Mobile IP Registration Request Message Format (Page 2 of 2)

Field Name	Size (bytes)	Description
Identification	8	Identification: A 64-bit number that uniquely identifies the <i>Registration Request</i> and is used to match requests to replies. It also provides protection against replay attacks; see the topic on Mobile IP security issues for more .
Extensions	Variable	Extensions: Extension fields are included here for authentication of the request. Other extensions may also be included.



Related Information: See [the topic on Mobile IP encapsulation](#) for more on minimal and GRE encapsulation and reverse tunneling.

Registration Reply Message Format

Registration Reply messages are formatted as shown in [Table 85](#) and [Figure 133](#).

Table 85: Mobile IP Registration Reply Message Format

Field Name	Size (bytes)	Description
Type	1	Type: Identifies the registration message type. For a reply, this field is 3.
Code	1	Code: Indicates the result of the registration request. This field is set to 0 if the registration was accepted, 1 if it was accepted but simultaneous bindings were requested and are not supported. If the registration was denied, a different reason code is provided that indicates the reason for the rejection, as well as whether it was the home agent or foreign agent that denied it.
Lifetime	2	Lifetime: If the registration was accepted, the length of time in seconds until the registration expires. This may of course be a different value than the mobile node requested.
Home Address	4	Home Address: The home (normal) IP address of the mobile node when on its home network. Uniquely identifies the device regardless of how the request is conveyed to the home agent, so the message can be delivered to it if multiple mobile nodes are served by the same foreign agent.
Home Agent	4	Home Agent: The IP address of the device acting as the mobile node's home agent.
Identification	8	Identification: A 64-bit number that uniquely identifies the <i>Registration Reply</i> and is matched to the Identification field of the request that precipitated it.
Extensions	Variable	Extensions: Extension fields are included here for authentication of the reply. Other extensions may also be included.

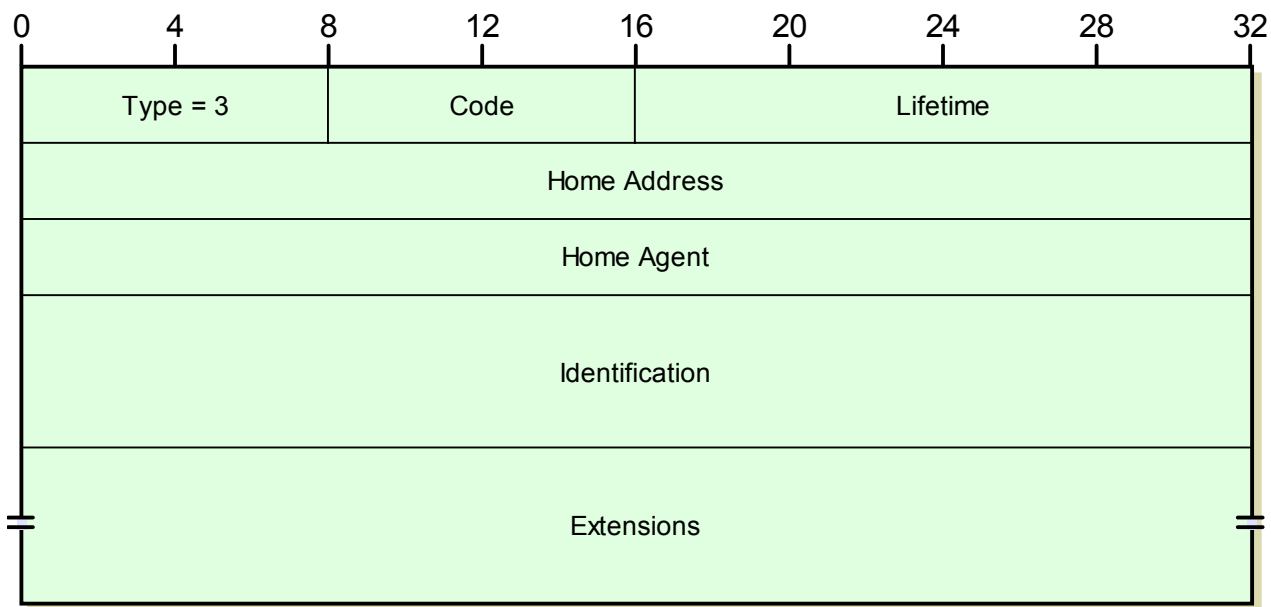

Figure 133: Mobile IP Registration Reply Message Format

This message is carried in the payload of a User Datagram Protocol (UDP) message, the headers of which are not shown.

Mobile IP Data Encapsulation and Tunneling

Once a mobile node on a foreign network has completed a successful [registration](#) with its home agent, the Mobile IP datagram forwarding process described in [the general operation topic](#) will be fully “activated”. The home agent will intercept datagrams intended for the mobile node as they are routed to its home network, and forward them to the mobile node. This is done by *encapsulating* the datagrams and then sending them to the node's care-of address.

Mobile IP Data Encapsulation Techniques

Encapsulation is required because each datagram we intercept and forward needs to be resent over the network to the device's care-of address. In theory, the designers might conceivably have done this by just having the home agent change the destination address and stick it back out on the network, but there are various complications that make this unwise. It makes more sense to take the entire datagram and wrap it in a new set of headers before retransmitting. In our [mail analogy](#), this is comparable to taking a letter received for our traveling consultant and putting it into a fresh envelope for forwarding, as opposed to just crossing off the original address and putting a new one on.

The default encapsulation process used in Mobile IP is called *IP Encapsulation Within IP*, defined in RFC 2003 and commonly abbreviated *IP-in-IP*. It is a relatively simple method that describes how to take an IP datagram and make it the payload of another IP datagram. In Mobile IP, the new headers specify how to send the encapsulated datagram to the mobile node's care-of address.

In addition to IP-in-IP, two other encapsulation methods may be optionally used: *Minimal Encapsulation Within IP*, defined in RFC 2004, and *Generic Routing Encapsulation (GRE)*, defined in RFC 1701. To use either of these, the mobile node must request the appropriate method in its *Registration Request* and the home agent must agree to use it. If foreign agent care-of addressing is used, the foreign agent also must support the method desired.

The Mobile IP Data Delivery Tunnel

The encapsulation process creates a logical construct called a *tunnel* between the device that encapsulates and the one that decapsulates. This is the same idea of a tunnel used in discussions of virtual private networks (VPNs), [IPSec tunnel mode](#), or the various other tunneling protocols used for security. The tunnel represents a conduit over which datagrams are forwarded across an arbitrary internetwork, with the details of the encapsulated datagram (meaning the original IP headers) temporarily hidden.

In Mobile IP, the start of the tunnel is the home agent, which does the encapsulation. The end of the tunnel depends on what sort of care-of address is being used:

- ☉ **Foreign Agent Care-Of Address:** The foreign agent is the end of the tunnel. It receives encapsulated messages from the home agent, strips off the outer IP header and then delivers the datagram to the mobile node. This is generally done using layer two, because the mobile node and foreign agent are on the same local network, and of course, the mobile node does not have its own IP address on that network (it is using that of the foreign agent.)
- ☉ **Co-Located Care-Of Address:** The mobile node itself is the end of the tunnel and strips off the outer header.

Mobile IP Conventional Tunneling

Normally, the tunnel described above is used only for datagrams that have been sent to the mobile node and captured by the home agent. When the mobile nodes wants to send a datagram, it doesn't tunnel it back to the home agent; this would be needlessly inefficient. Instead it just sends out the datagram directly using whatever router it can find on its current network, which may or may not be a foreign agent. When it does this, it uses its own home address as the source address for any requests it sends. As a result, any response to those requests will go back to the home network. This sets up a “triangle” of sorts for these kinds of transactions:

1. The mobile node sends a request from the foreign network to some third party device somewhere on the internetwork.
2. The third party device responds back to the mobile node. However, this sends the reply back to the mobile node's home address on its home network.
3. The home agent intercepts the response on the home network and tunnels it back to the mobile node.

This process is illustrated in [Figure 134](#). The reverse transaction would be pretty much the same, just in the reverse order. In that case the third party (Internet) device would send a request to mobile node, which would be received and forwarded by the home agent. The mobile node would reply back directly to the Internet host.

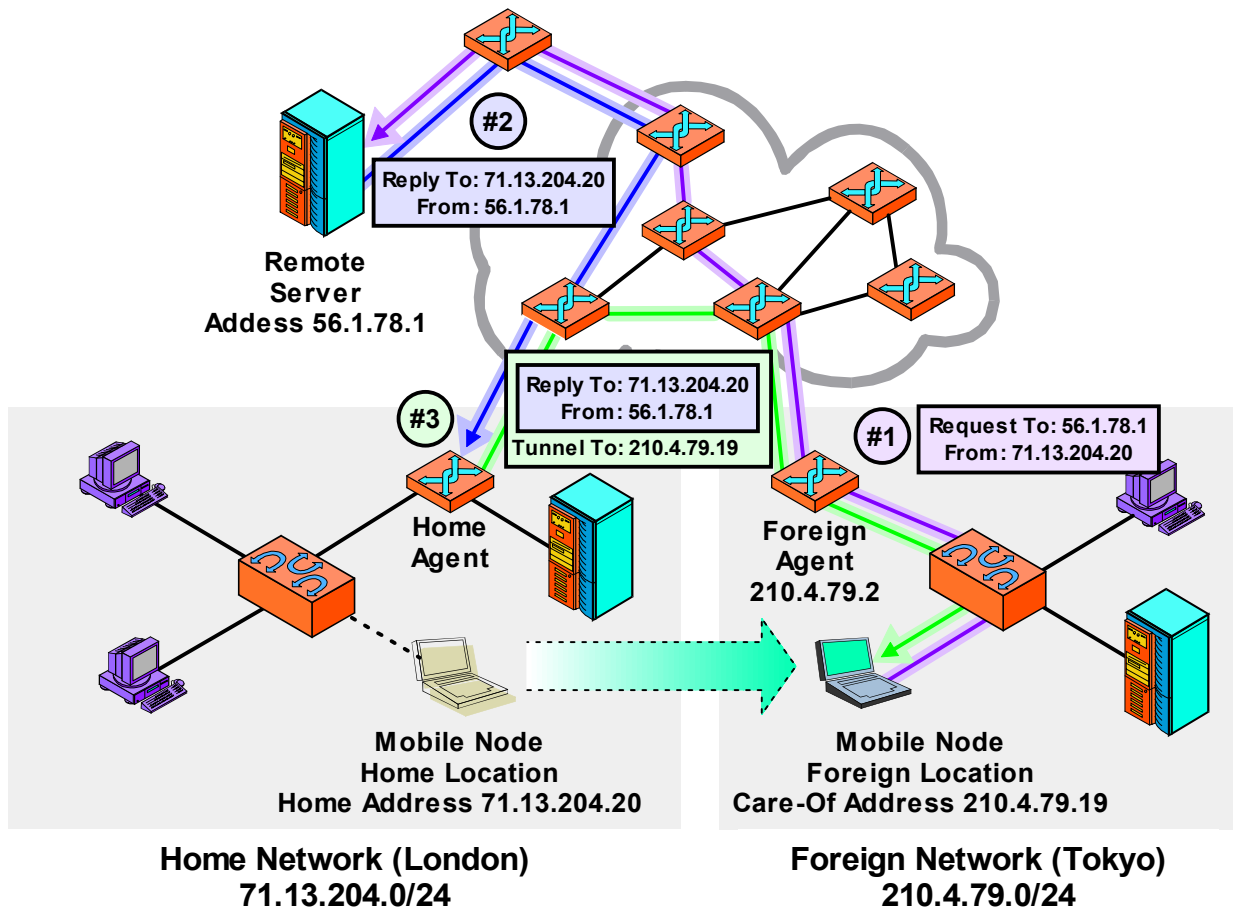

Figure 134: Mobile IP Encapsulation and Tunneling

This example illustrates how a typical request/reply message exchange in Mobile IP results in a “triangle” of communication. In step #1, the mobile node sends a request to a remote server somewhere on the Internet. It uses its own home address as the source for this request, so in step #2 the reply goes back to the home agent. Step #3 consists of the home agent tunneling the reply back to the mobile node.



Key Concept: Once Mobile IP is set up and operational, it works by having the home agent *encapsulate* and *tunnel* received datagrams to the mobile node. The mobile device normally sends datagrams directly to Internet hosts, which respond back to the mobile’s home agent which forwards those datagrams to the mobile node. This means a request/reply communication takes three transmissions.

Mobile IP Reverse Tunneling

There may be situations where it is not feasible or desired to have the mobile node send datagrams directly to the internetwork using a router on the foreign network as we just saw. In this case, an optional feature called *reverse tunneling* may be deployed, if it is supported by the mobile node, the home agent and if relevant, the foreign agent.

When this is done, a reverse tunnel to complement the normal one is set up between the mobile node and the home agent, or between the foreign agent and the home agent, depending on care-of address type. All transmissions from the mobile node are tunneled back to the home network where the home agent transmits them over the internetwork, resulting in a more symmetric operation rather than the “triangle” just described. This is basically what I described earlier as being “needlessly inefficient”, because it means each communication requires four steps. Thus, it is used only when necessary.

One situation where reverse tunneling may be required is if the network where the mobile node is located has implemented certain security measures that prohibit the node from sending datagrams using its normal IP address. In particular, a network may be set up to disallow outgoing datagrams with a source address that doesn’t match its network prefix. This is often done to prevent “spoofing” (impersonating another’s IP address.)



Key Concept: An optional feature called *reverse tunneling* may be used in certain cases, such as when a network does not allow outgoing datagrams with a foreign source IP address. When enabled, rather than sending datagrams directly, the mobile node tunnels all transmissions back to the home agent, which sends them on the Internet.

Note that everything I've just discussed is applicable to “normal”—meaning unicast—datagrams sent to and from the mobile node. Broadcast datagrams on the home network, which would normally be intended for the mobile node if it were at home, are not forwarded unless the node specifically asks for this service during registration. Multicast operation on the foreign network is also supported, but extra work is required by the mobile node to set it up.

Mobile IP and TCP/IP Address Resolution Protocol (ARP) Operation

Mobile IP is a protocol that does a good job of implementing a difficult function: transparently allowing an IP device to travel to a different network. Unfortunately, a problem with any protocol that tries to change how IP works is dealing with “special cases”. Having a home agent [intercept datagrams and tunnel them to the mobile node](#) works well in general terms, but there are some places where extra work is required. One of these is the use of the [TCP/IP Address Resolution Protocol \(ARP\)](#), which under Mobile IP “breaks” unless we take special steps.



Background Information: Some understanding of how ARP works in general terms is assumed in this topic. This includes [ARP proxying](#).

Difficulties With Mobile IP and ARP

To understand the problem with ARP, consider a mobile node that is on a foreign network and has successfully [registered](#) with its home agent. The home agent will intercept all datagrams that come onto the home network intended for the mobile node, and then encapsulate and forward them. For this to happen, though, the home agent (home router) must see the datagram. This normally only occurs when a datagram comes onto the home network from the “outside” and is processed by the router.

What happens when a local device on the home network itself wants to transmit to a mobile node that has traveled elsewhere? Remember that this device may not be mobile itself and probably knows nothing about Mobile IP. It will follow the standard process for deciding what to do with a datagram it needs to send as explained in [the topic discussing direct and indirect delivery of IP datagrams](#). It will compare its network ID to that of the mobile node and realize it doesn't need to route its datagram; it can send it directly to the mobile node.

The local host will attempt to use ARP to find the data link layer address of the mobile node so it can send the datagram to it directly. It will start by looking in its ARP cache and if it finds the node's data link layer address there, will use it to send at layer two. Of course the mobile node is no longer on the local network segment so the message will never be received. If there is no ARP cache entry, the host on the home network will attempt to send an *ARP Request* to the mobile node to determine its layer two address. Again, the mobile node has traveled away, so this request will go unanswered.

Additional Home Agent Tasks To Deal With ARP

Solving this problem requires the intervention of, you guessed it, the home agent. It must perform two tasks to enable local hosts to send to the mobile node:

- ① **ARP Proxying:** The home agent must listen for any *ARP Requests* sent by nodes on the same network as any of the mobile nodes that are currently registered to it. When it hears one, it replies in the mobile node's stead, and specifies ***its own*** data link layer address as the binding for the mobile node's IP address. This will cause hosts on the home network to send any datagrams intended for the mobile node to the home agent where they can be forwarded. This process is illustrated in [Figure 135](#).
- ② **“Gratuitous” ARP:** Proxying helps with *ARP Requests* but what about devices that already have cache entries for the mobile node? As soon as the mobile node leaves the network, these become automatically stale. To correct them, the home agent sends what is called a *gratuitous* ARP message that tells devices on the local network to associate the mobile node's IP address with the home agent's data link layer

address. The term “gratuitous” refers to the fact that the message isn't being sent in order to perform an actual address resolution but merely to cause caches to be updated. It may be sent more than once to ensure that every device “gets the message”.

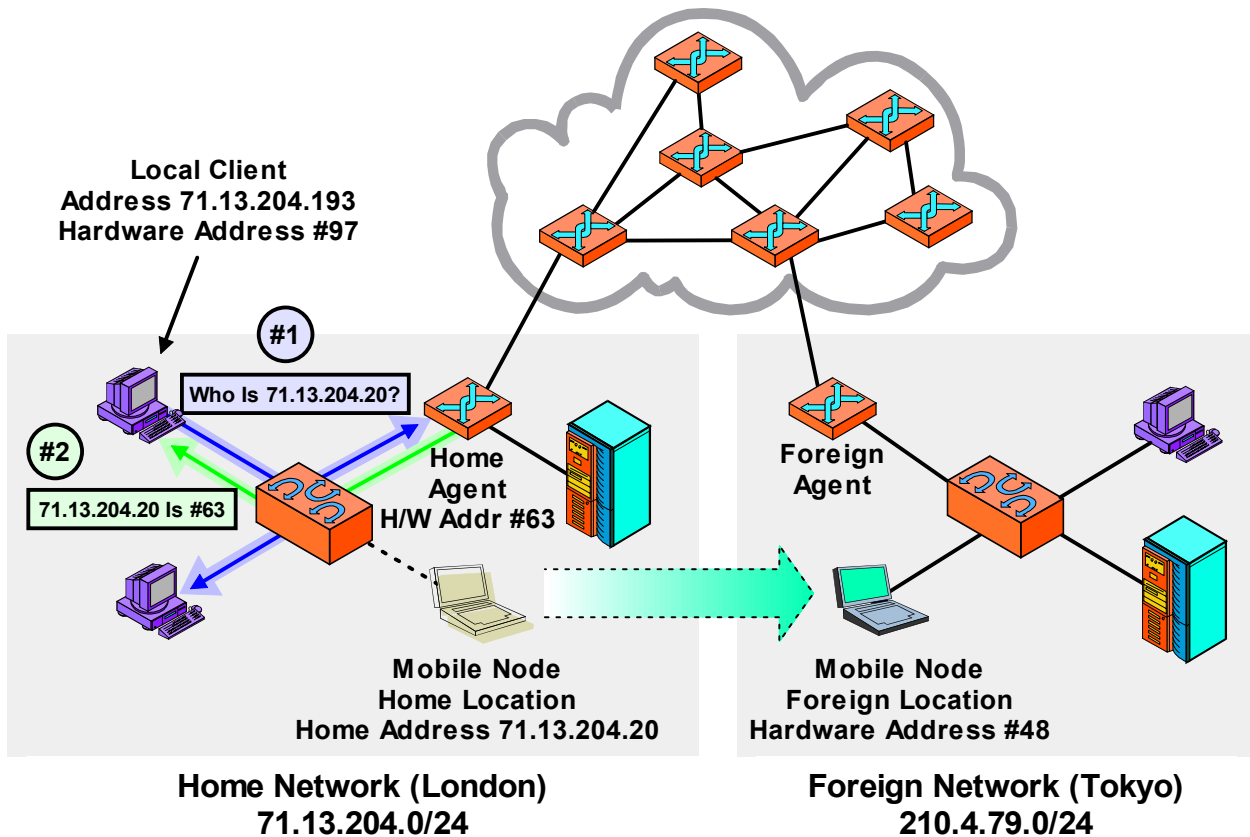

Figure 135: ARP Proxying By Mobile IP Home Agent

The home agent must take special steps to deal with transmissions from devices on the local network to the mobile node. In this example (using short hardware addresses for simplicity) the hardware address of the mobile node is #48 and that of the home agent #63. A local client on the home network with hardware address #97 sends an *ARP Request* to find out the hardware address of the mobile node. The home agent responds on the mobile's behalf, specifying not hardware address #48 but rather its own, #63. The client will thus send to the home agent, which can then forward the data to the mobile node on the foreign network.

Once this is done, ARP should function normally on the home link. Of course, when the mobile device returns back to the home network, the process must be reversed. Upon deregistration with the home agent, it will stop proxying for the mobile node. Both the mobile node and the home agent will also send gratuitous ARP broadcasts that update local device caches to again associate the mobile node's IP address with its own layer two address, instead of that of the home agent.



Key Concept: To avoid problems with hosts on the mobile node's home network trying to send datagrams to it at layer two, the home agent is required to use proxy ARP to direct such devices to send to the home agent so they can be forwarded. It must also use "gratuitous" ARP to update any existing ARP caches to that effect.

Mobile IP Efficiency Issues

Having the [home agent forward all datagrams to the mobile node wherever it may be](#) is a convenient solution to mobility, but is also a rather inefficient one. Since every datagram must be sent first to the home network and then be forwarded to the mobile node, datagrams are going to travel over some part of the internetwork twice. The degree of inefficiency represented by forwarding can be significant, and may lead to problems with certain applications.

To see what the problem is, let's consider a traveling mobile node *M* and a regular device that wants to send to it, device *A*. The degree of the inefficiency of Mobile IP is a function of the internetwork distance between device *A* and *M*'s home network, compared to the internetwork distance between device *A* and *M*'s current network. By distance here, I mean the term as it is used in determining routes on an internetwork; two devices are "closer" when it takes less time and/or fewer hops to communicate between them, and "farther" when it takes more. (I use geography in my examples below to represent this notion of distance, but remember that geographical distance is only one factor in internetwork distance.)

The Impact on Efficiency of Sending Device Location

Let's consider the case where mobile node *M* is on a foreign network quite far from home, and a sending device, device *A*, wants to send a datagram using node *M*'s home IP address. Suppose the home network is in London and the device is again in Tokyo, Japan. The following examples are arranged in order of increasing inefficiency of Mobile IP, compared to the alternative of having the mobile node just get a new temporary IP address on the foreign network and not use Mobile IP:

- ☉ **Sending Device On Home Network:** In this situation, device *A* will send a datagram that is immediately intercepted by the home agent on the home network and forwarded to the mobile node. There is really no inefficiency here at all (except for overhead for encapsulation and such) because even if *A* sent directly to the mobile node with a new foreign address, it would probably be routed through the home agent router anyway.
- ☉ **Sending Device On Network Close To Home Network:** Here, let's say a device in Paris, France wants to send to the mobile node. The datagram goes from Paris to London and then to Tokyo. That's not too bad.
- ☉ **Sending Device On Network Close To Foreign Network:** Now, suppose the sending device is in Taipei, Taiwan. In this situation, Mobile IP becomes **quite** inefficient. The datagram must be sent from Taipei all the way to London, and then all the way back to Tokyo.

- ☉ **Sending Device On Foreign Network:** The greatest inefficiency results when the sending device is actually on the foreign network that the mobile node is visiting. If device A is on the mobile node's current network in Tokyo, it must send all the way to London and then have the result forwarded all the way back again to Tokyo. Without Mobile IP, all we would need to do is use ARP and then deliver directly at layer two without routing needed at all! This scenario is illustrated in [Figure 136](#).

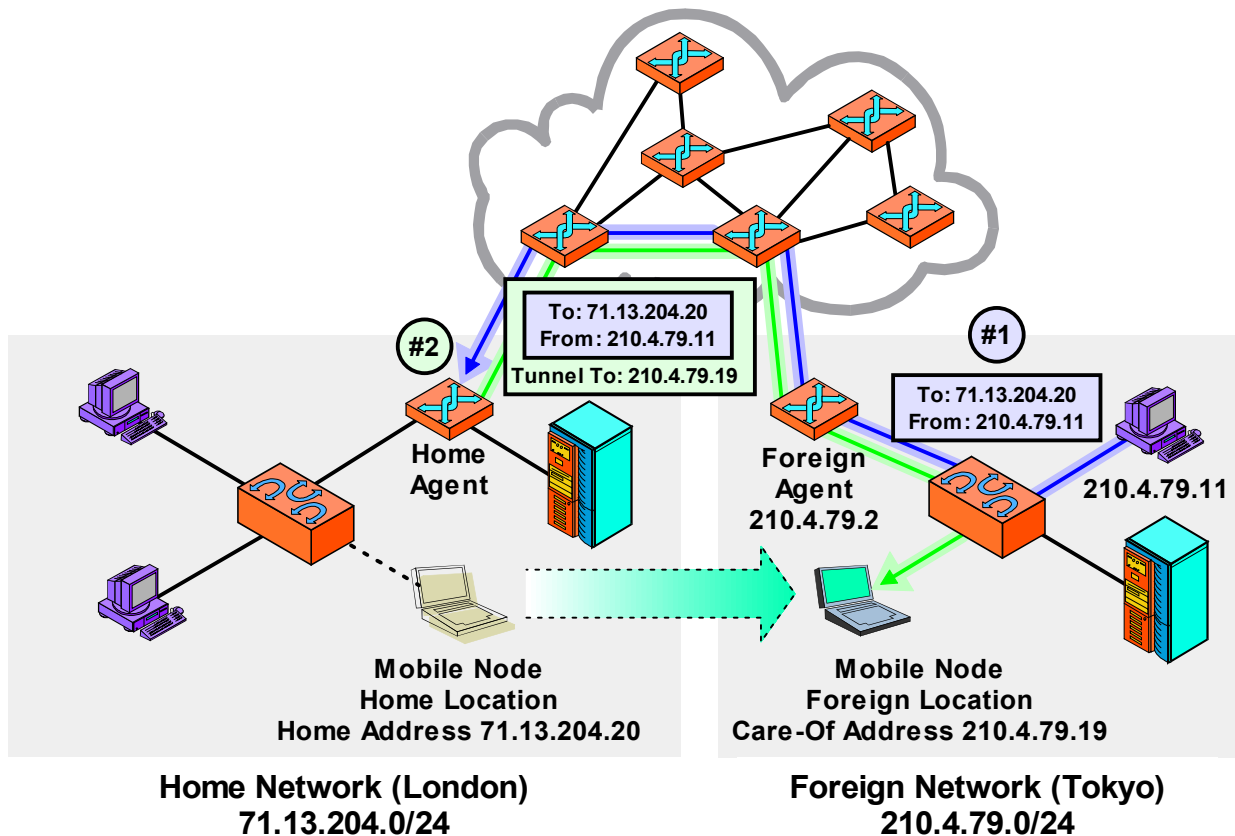

Figure 136: A Mobile IP Inefficiency “Worst Case Scenario”

This diagram shows the worst possible case of Mobile IP inefficiency: when a device on the foreign network where the mobile is located tries to send to it. The sender here, 210.4.79.11, uses the mobile node's home address, so the transmission must be routed all the way back to London and then forwarded back to Tokyo, even though the two devices might be sitting on the same desk!

Unfortunately, the “worst case scenario” outlined in the last bullet point is one that occurs quite often. It's common for a mobile device to connect with a foreign network specifically to communicate with the hosts on that network

Implications of Reverse Tunneling

To make matters worse, consider what happens if [reverse tunneling](#) is used! Here, tunneling is done not just for datagrams sent to the mobile node but sent from it as well. In our “worst case” example, a request/reply pair from the mobile node to another device on the foreign network requires **two** complete round-trips from Tokyo to London and back. Clearly, this is far from ideal.

Inefficiency is an Inherent Part of Mobile IP

There really isn't any solution to this problem within Mobile IP itself; it's just a natural consequence of how the protocol works. The only way to really improve things is to "hack in" a solution that ultimately boils down to one of the two options we always have in IP without mobility support: we either decide to give the mobile device a temporary real IP address on the foreign network, or we use a host-specific route for the mobile device while on the foreign network.

We've already seen that these both have problems, which is why Mobile IP was created in the first place. There may be situations, however, where efficiency is more important than the transparent portability that Mobile IP provides. For a long-term deployment on a foreign network far from the home network, or for applications where efficiency is paramount, it may make sense to employ one of these techniques. For example, a corporation that has a small number of offices in different cities connected using the Internet might set up special routing. This would let mobile devices visiting from other cities talk directly to nodes local to the foreign part of the network without being routed across the Internet.



Key Concept: Since datagrams are sent to a mobile node at its home address, each datagram sent to the mobile device must first go back to its home network and then be forwarded to its current location. The level of inefficiency that results depends on how far the sender is from the mobile's home network. The worst case actually occurs if the sender and mobile are on the same foreign network, in which case each transmission must make a round-trip to the mobile's home network and then back again. This is an inherent part of how Mobile IP and cannot readily be rectified.

Mobile IP Security Considerations

Security is always a concern in any internetworking environment these days, but is especially important with Mobile IP. There are a number of reasons for this, which are related to both how the protocol is used and the specific mechanisms by which it is implemented.

In terms of use, security was kept in mind during Mobile IP's development because mobile devices often use wireless networking technologies. Wireless communication is inherently less secure than wired communication, because transmissions are sent "out in the open" where they can be intercepted. It's also easier for malicious users to possibly disrupt the operation of wireless devices than when they connect using wires.

In terms of operation, Mobile IP has a number of risks due to it using a registration system and then forwarding datagrams across an unsecured internetwork. A malicious device could interfere with [registration process](#), causing the datagrams intended for a mobile device to be diverted. A "bad guy" might also interfere with the [data forwarding process](#) itself, by encapsulating a bogus datagram to trick a mobile node into thinking it was sent something that it never was.

Mobile IP Security Provisions

For these reasons, the Mobile IP standard includes a limited number of explicit provisions to safeguard against various security risks. One security measure was considered sufficiently important that it was built into the Mobile IP standard directly: authentication of *Registration Request* and *Registration Reply* messages. This authentication process is accomplished in a manner somewhat similar to how the IPsec [Authentication Header \(AH\)](#) operates. Its goal is to prevent unauthorized devices from intercepting traffic by tricking an agent into setting up, renewing or canceling a registration improperly.

All Mobile IP devices are required to support authentication. Nodes must use it for requests and agents must use it for replies. Keys must be assigned manually as there is no automated system for secure key distribution. The default authentication method uses *HMAC-MD5* (specified in RFC 2403), which is one of two hashing algorithms used by [IPsec](#).

Protecting Against Replay Attacks

Another concern is a security problem called a *replay attack*. In this type of attack, a third party intercepts a datagram, holds onto it and then re-sends it later on. This seems fairly harmless, but consider the importance of timing. Imagine a mobile node registers with its home agent, then later returns home and deregisters. If a malicious device captures a copy of the original *Registration Request* and re-sends it, the home agent might be fooled into thinking the node has traveled away from home when it has not. It could then intercept the forwarded datagrams.

The *Identification* field used in *Registration Request* and *Registration Reply* messages is designed to prevent replay attacks. Since each request has a different *Identification* number, nodes and agents can match up requests with replies and reject any datagrams they receive that are repeats of ones they have seen already. The Mobile IP standard also specifies alternative methods for protecting against replays.

Limitations of Mobile IP Authentication

While Mobile IP includes authentication measures for registration messages, it does not for other types of messages. It also doesn't specify authentication of encapsulated datagrams being forwarded from the home agent to the mobile node. Encryption is also not provided to safeguard the privacy of either control messages or forwarded datagrams. The obvious solution when stronger assurances of privacy or authenticity are required is to make use of the IPsec [Authentication Header \(AH\)](#) and/or [Encapsulating Security Payload \(ESP\)](#) protocols.



Internet Control Message Protocol (ICMP/ICMPv4 and ICMPv6)

The [Internet Protocol \(IP\)](#) is the key network layer protocol that implements the [TCP/IP protocol suite](#). Since IP is the protocol that provides the mechanism for delivering datagrams between devices, it is designed to be relatively basic, and to function with few “bells and whistles”. One of the provisions it lacks is some way to allow errors to be reported back to a transmitting device, and for tests and special tasks to be accomplished. However, these capabilities are necessary for the operation of an internetwork, so TCP/IP defines an adjunct protocol for IP that provides them: the *Internet Control Message Protocol (ICMP)*

In this section I describe the operation of ICMP using two main subsections. The first subsection describes ICMP concepts and operation in general terms, including a look at the overall method by which ICMP messages are packaged and the circumstances under which they are sent. The second subsection provides detailed descriptions of each of the individual message types supported by ICMP.

ICMP was developed to be a companion to the [original Internet Protocol, version 4](#). With the creation of [IP version 6 \(IPv6\)](#), a new version of ICMP called (ta-da) *ICMP version 6 (ICMPv6)* was created as well, and the original ICMP is now sometimes called *ICMPv4* to differentiate it, just as the “old” IP is now often called “IPv4”. These two versions have some differences in their specifics, but really are very similar in overall operation. For this reason, I decided to integrate the general operation description of both versions of ICMP, and just point out where the differences are between them. The area where IPv4 and IPv6 most differ is in specific message types and formats, so these have been described separately in the second subsection.



Background Information: Due to the close relationship between ICMP and IP, this section assumes familiarity with basic IP concepts, including [IP addressing](#), the [general format of IP datagrams](#) and [how they are routed](#). To better understand ICMPv6 details, you may also want to reference the [IPv6 addressing](#) and [datagram encapsulation](#) topics, and especially the [IPv6 Neighbor Discovery \(ND\) protocol](#).

ICMP Concepts and General Operation

The Internet Control Message Protocol (ICMP) is one of the under-appreciated “worker bees” of the networking world. Everyone knows how important key protocols such as the Internet Protocol are to TCP/IP, but few realize that the suite as a whole relies on many functions that ICMP provides. Originally created to allow the reporting of a small set of error conditions, ICMP messages are now used to implement a wide range of error-reporting, feedback and testing capabilities. While each message type is unique, they are all implemented using a common message format, sent and received based on relatively simple protocol rules. This makes ICMP one of the easiest TCP/IP protocols to understand. (Yes, I actually said something in this Guide was **easy!**)

In this section I provide a general description of ICMP. I begin with an overview of ICMP, discussing its purpose, history, and the versions and standards that define it. I describe the general method by which ICMP operates, and also discuss the rules that govern how and when ICMP messages are created and processed. I then outline the common format used for ICMP messages in ICMPv4 and ICMPv6, and how data is encapsulated in them in general terms. I conclude with a discussion of ICMP message classifications, and a summary of different message types and codes for both version 4 and version 6.

ICMP Overview, History, Versions and Standards

The Internet Protocol is the foundation of the TCP/IP protocol suite, since it is the mechanism responsible for delivering datagrams. Three of the main [characteristics that describe IP's datagram delivery method](#) are *connectionless*, *unreliable* and *unacknowledged*. This means that datagrams are “just sent” over the internetwork with no prior connection established, no assurance they will show up, and no acknowledgement sent back to the sender that they arrived. On the surface, this seems like it would result in a protocol that is difficult to use and impossible to rely on, and therefore a poor choice for designing a protocol suite. However, even though IP “makes no guarantees”, it works very well because most of the time, IP internetworks are sufficiently robust that messages get where they need to go.

Even the best-designed system still encounters problems, of course. Incorrect packets are occasionally sent, hardware devices have problems, routes are found to be invalid, and so forth. IP devices also often need to share specific information to guide them in their operation, and to perform tests and diagnostics. However, IP itself includes no provision to allow devices to exchange low-level control messages. Instead, these features are provided in the form of a “companion” protocol to IP called the *Internet Control Message Protocol (ICMP)*.

The Relationship Between IP and ICMP

I think a good analogy for the relationship between IP and ICMP is to consider the one between a high-powered executive, and her experienced administrative assistant. The executive is busy and her time is very expensive. She is paid to do a specific job and to do it well, and not to spend time on administrative tasks. However, without **someone** doing

those tasks, the executive could not do her job properly. The administrative assistant does the also-important support jobs that make it possible for the executive to focus on her work. The working relationship between them is very important; a good pair will work together like a cohesive team, even anticipating each others' needs.

In TCP/IP, the [Internet Protocol](#) is the executive, and ICMP is its “administrative assistant”. IP focuses on its core activities, such as addressing, datagram packaging and routing. ICMP provides critical support to IP in the form of *ICMP messages* that allow different types of communication to occur between IP devices. These messages use a common general format, and are encapsulated in IP datagrams for transmission. They are divided into different categories, and each type has a specific use and internal field format.

Just as an administrative assistant often has a special location in an organization chart, usually connecting with a “dotted line” directly to the executive he or she assists, ICMP occupies a unique place in the [TCP/IP protocol architecture](#). Technically, one might consider ICMP to belong to layer four, since it creates messages that are encapsulated in IP datagrams and sent using IP at layer three. However, in the standard that first defined it, ICMP is specifically declared to be not only part of the network layer, but:

“actually an integral part of IP, [that] must be implemented by every IP module”.

ICMP Standards for IPv4 and IPv6

The defining standard I just quoted, by the way, is RFC 792. This was the initial defining standard for ICMP, titled simply *Internet Control Message Protocol*. It was published at the same time as the standard for IP, which was RFC 791. This is further indication that IP and ICMP really are a “team” of sorts.

Due to the close relationship between the two, when the [new version 6 of the Internet Protocol \(IPv6\)](#) was developed in the mid-1990s, it was necessary to define a new version of ICMP as well. This was of course called the *Internet Control Message Protocol (ICMPv6) for the Internet Protocol Version 6 (IPv6) Specification*, first published as RFC 1885 in 1995, and revised in RFC 2463 in 1998. Just as the original IP is now often called IPv4 to differentiate it from IPv6, the original ICMP is now also called *ICMPv4*.

These two RFCs, 792 and 2463, define the basic operation of ICMPv4 and ICMPv6 respectively, and also describe some of the ICMP message types supported by each version of the protocol. ICMPv4 and ICMPv6 are very similar in most general respects, though they have some differences, most of which are a direct result of the changes made to IP itself. Another document, RFC 1122 (*Requirements for Internet Hosts - Communication Layers*) contains rules for how ICMPv4 is used, as we will see in [the topic on ICMP message creation and processing conventions](#). RFC 1812 (*Requirements for IP Version 4 Routers*) is also relevant.



Key Concept: In TCP/IP, diagnostic, test and error-reporting functions at the internet/network layer are performed by the *Internet Control Message Protocol (ICMP)*, which is like the Internet Protocol's “administrative assistant”. The original version, now called *ICMPv4*, is used with IPv4, and the newer *ICMPv6* with IPv6.

Other Standards That Define ICMP Messages

Both versions of the protocol define a general messaging system that was designed to be expandable. This means that in addition to the messages defined in the ICMP standards themselves, other protocols may also define message types used in ICMP. Some of the more important of these are shown in [Table 86](#).

Table 86: Non-ICMP Internet Standards That Define ICMP Messages

ICMP Version of Message Types Defined	RFC Number	Name	ICMP Message Types Defined
ICMPv4	950	<i>Internet Standard Subnetting Procedure</i>	<i>Address Mask Request, Address Mask Reply</i>
	1256	<i>ICMP Router Discovery Messages</i>	<i>Router Advertisement, Router Solicitation</i>
	1393	<i>Traceroute Using an IP Option</i>	<i>Traceroute</i>
	1812	<i>Requirements for IP Version 4 Routers</i>	Defines three new codes (subtypes) for the <i>Destination Unreachable</i> message.
ICMPv6	2461	<i>Neighbor Discovery for IP Version 6 (IPv6)</i>	<i>Router Advertisement, Router Solicitation, Neighbor Advertisement, Neighbor Solicitation, Redirect</i>
	2894	<i>Router Renumbering for IPv6</i>	<i>Router Renumbering</i>

The topic on [ICMP message classifications, types and codes](#) includes a full list of the ICMPv4/ICMPv6 message types covered in this Guide and the standards that define each.

ICMP General Operation

ICMP is one of the simplest protocols in the TCP/IP protocol suite. Most protocols implement a particular type of functionality to either facilitate basic operation of a part of the network stack, or an application. To this end they include many specific algorithms and tasks that define the protocol, which is where most of the complexity lies. ICMP, in contrast, is exactly what its name suggests: a protocol that defines control messages. As such, pretty much all of what ICMP is about is providing a mechanism for any IP device to send control messages to another device.

The ICMP Message-Passing Service

Various message types are defined in ICMP that allow different types of information to be exchanged. These are usually either generated for the purpose of reporting errors, or for exchanging important information of different sorts that is needed to keep IP operating smoothly. ICMP itself doesn't define how all the different ICMP messages are used; this is done by the protocols that use the messages. In this manner, ICMP describes a simple message-passing service to other protocols.



Key Concept: ICMP is not like most other TCP/IP protocols in that it does not perform a specific task. It defines a mechanism by which various control messages can be transmitted and received to implement a variety of functions.

As mentioned in [the preceding overview topic](#), ICMP is considered an integral part of IP, even though it uses IP to send its messages. Typically, the operation of ICMP involves some portion of the TCP/IP protocol software on a machine detecting a condition that causes it to generate an ICMP message. This is often the IP layer itself, though it may be some other part of the software. The message is then encapsulated and transmitted like any other TCP/IP message, and is given no special treatment compared to other IP datagrams. The message is sent over the internetwork to the IP layer at the receiving device, as shown in [Figure 137](#).

Again, since many of the ICMP messages are actually intended to convey information to a device's IP software, the IP layer itself may be the “ultimate destination” of an ICMP message once a recipient gets it. In other cases, the ultimate destination may be some other part of the TCP/IP protocol software, which is determined by the type of message received. ICMP does not use [ports](#) like [UDP](#) or [TCP](#) to direct its messages to different applications on a host; the software recognizes the message type and directs it accordingly within the software.

ICMP was originally designed with the idea that most messages would be sent by routers, but they can be sent by both routers and by regular hosts as well, depending on the message type. Some are obviously only sent by routers, such as *Redirect* messages, while others may be sent by either routers or hosts. Many of the ICMP messages are used in matched pairs, especially various kinds of *Request* and *Reply* messages, and *Advertisement* and *Solicitation* messages.

ICMP Error-Reporting Limitations

One interesting general characteristic of ICMP's operation is that when errors are detected, they can be reported using ICMP, but only back to the original source of a datagram. This is actually a big drawback in how ICMP works. Refer back to [Figure 137](#) and consider again client host *A* sending a message to server host *B*, with a problem detected in the datagram

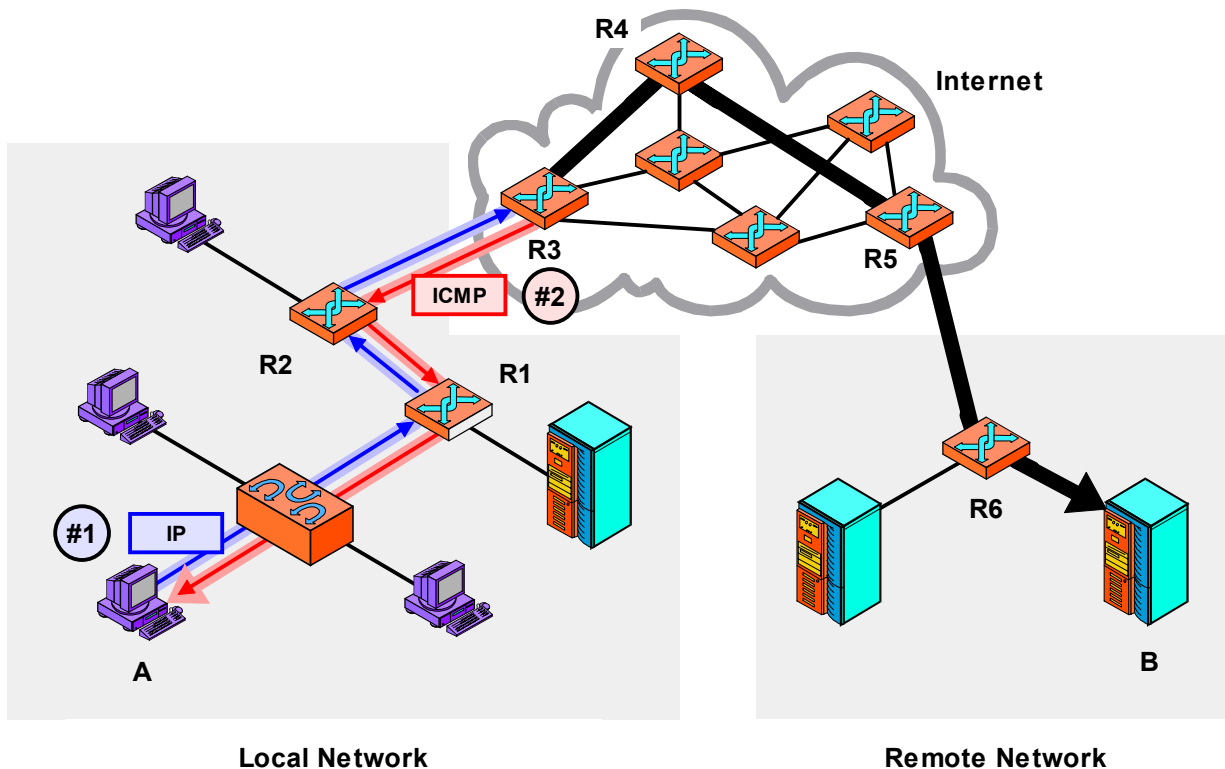

Figure 137: ICMP General Operation

A typical use of ICMP is to provide a feedback mechanism when an IP message is sent. In this example, device *A* is trying to send an IP datagram to device *B*. However, when it gets to router *R3* a problem of some sort is detected that causes the datagram to be dropped. *R3* sends an ICMP message back to *A* to tell it that something happened, hopefully with enough information to let *A* correct the problem, if possible. *R3* can only send the ICMP message back to *A*, not to *R2* or *R1*.

by router *R3*. Even if *R3* suspects that the problem was caused by one of the preceding routers that handled the message, such as *R2*, it **cannot** send a problem report to *R2*. It can only send an ICMP message back to host *A*.

This limitation is an artifact of how the Internet Protocol works. You may recall from looking at [the IP datagram format](#) that the only address fields are for the original source and ultimate destination of the datagram. (The only exception is if the *IP Record Route* option is used, but devices cannot count on this.) When *R3* receives a datagram from *R2* that *R2* in turn received from *R1* (and prior to that, from *A*), it is only *A*'s address in the datagram. Thus, *R3* **must** send a problem report back to *A*, and *A* must decide what to do with it. Device *A* may decide to change the route it uses, or to generate an error report that an administrator can use to troubleshoot the *R2* router.

In addition to this basic limitation, several [special rules and conventions](#) have been put in place to govern the circumstances under which ICMP messages are generated, sent and processed.



Key Concept: ICMP error-reporting messages sent in response to a problem seen in an IP datagram can only be sent back to the originating device. Intermediate devices cannot be the recipient of an ICMP message because their addresses are normally not carried in the IP datagram's header.

ICMP Message Classes, Types and Codes

ICMP messages are used to allow the communication of different types of information between IP devices on an internetwork. The messages themselves are used for a wide variety of purposes, and are organized into general categories, as well as numerous specific types and subtypes.

ICMP Message Classes

At the highest level, ICMP messages are divided into two classes:

- ☉ **Error Messages:** These messages are used to provide feedback to a source device about an error that has occurred. They are usually generated specifically in response to some sort of action, usually the transmission of a datagram, as shown in the example of [Figure 137](#). Errors are usually related to the structure or content of a datagram, or to problem situations on the internetwork encountered during datagram routing.
- ☉ **Informational (or Query) Messages:** These are messages that are used to let devices exchange information, implement certain IP-related features, and perform testing. They do not indicate errors and are typically not sent in response to a regular datagram transmission. They are generated either when directed by an application, or on a regular basis to provide information to other devices. An informational ICMP message may also be sent in reply to another informational ICMP message, since they often occur in request/reply or solicitation/advertisement functional pairs.



Key Concept: ICMP messages are divided into two general categories: *error messages* that are used to report problem conditions, and *informational messages* that are used for diagnostics, testing and other purposes.

ICMP Message Types

Each individual kind of message in ICMP is given its own unique *Type* value, which is put into the field of that name in the ICMP common message format. This field is 8 bits wide, so a theoretical maximum of 256 message types can be defined. A separate set of *Type* values is maintained for each of ICMPv4 and ICMPv6.

In ICMPv4, *Type* values were assigned sequentially, to both error and informational messages, on a “first come, first served” basis (sort of) so one cannot tell just by the *Type* value what type of message each is. One minor improvement made in ICMPv6 was that the

message types were separated. In IPv6, error messages have *Type* values from 0 to 127, and informational messages have values from 128 to 255. Of course, only some of the *Type* values are currently defined.



Key Concept: A total of 256 different possible message types can be defined for each of ICMPv4 and ICMPv6. The *Type* field that appears in the header of each message specifies the kind of ICMP message. In ICMPv4 there is no relationship between *Type* value and message type; in ICMPv6 error messages have a *Type* value of 0 to 127, informational messages 128 to 255.

ICMP Message Codes

The message type indicates the general purpose of each kind of ICMP message. ICMP also provides an additional level of detail within each message type in the form of a *Code* field, which is also 8 bits. You can consider this field as a message “subtype”. Thus, each message type can have up to 256 subtypes that are more detailed subdivisions of the message's overall functionality. A good example is the *Destination Unreachable* message, which is generated [when a datagram cannot be delivered](#). In this message type, the *Code* value provides more information on exactly why the delivery was not possible.

ICMP Message Class and Type Summary

A complete section describing all of the major ICMP message types for both ICMPv4 and ICMPv6 has been included in this Guide. For convenience, I have summarized all these message types in [Table 87](#), which shows each of the *Type* values for the messages covered in this Guide, the name of each message, a very brief summary of its purpose, and the RFC that defines it. (To keep the table from being egregiously large I have not shown each of the *Code* values for each *Type* value; these can be found in the individual message

type descriptions.) The table is organized into sections in the same way as the [ICMP Message Types and Formats section](#), except this table is sorted by ascending *Type* value within each category, for easier reference.

Table 87: ICMP Message Classes, Types and Codes (Page 1 of 2)

Message Class	Type Value	Message Name	Summary Description of Message Type	Defining RFC Number
ICMPv4 Error Messages	3	<i>Destination Unreachable</i>	Indicates that a datagram could not be delivered to its destination. The <i>Code</i> value provides more information on the nature of the error.	792
	4	<i>Source Quench</i>	Lets a congested IP device tell a device that is sending it datagrams to slow down the rate at which it is sending them.	792
	5	<i>Redirect</i>	Allows a router to inform a host of a better route to use for sending datagrams.	792
	11	<i>Time Exceeded</i>	Sent when a datagram has been discarded prior to delivery due to expiration of its <i>Time To Live</i> field.	792
	12	<i>Parameter Problem</i>	Indicates a miscellaneous problem (specified by the <i>Code</i> value) in delivering a datagram.	792
ICMPv4 Informational Messages (part 1 of 2)	0	<i>Echo Reply</i>	Sent in reply to an <i>Echo (Request)</i> message; used for testing connectivity.	792
	8	<i>Echo (Request)</i>	Sent by a device to test connectivity to another device on the internetwork. The word "Request" sometimes appears in the message name.	792
	9	<i>Router Advertisement</i>	Used by routers to tell hosts of their existence and capabilities.	1256
	10	<i>Router Solicitation</i>	Used by hosts to prompt any listening routers to send a <i>Router Advertisement</i> .	1256
	13	<i>Timestamp (Request)</i>	Sent by a device to request that another send it a timestamp value for propagation time calculation and clock synchronization. The word "Request" sometimes appear in the message name.	792
	14	<i>Timestamp Reply</i>	Sent in response to a <i>Timestamp (Request)</i> to provide time calculation and clock synchronization information.	792
	15	<i>Information Request</i>	Originally used to request configuration information from another device. Now obsolete.	792

Table 87: ICMP Message Classes, Types and Codes (Page 2 of 2)

Message Class	Type Value	Message Name	Summary Description of Message Type	Defining RFC Number
ICMPv4 Informational Messages (part 2 of 2)	16	<i>Information Reply</i>	Originally used to provide configuration information in response to an <i>Information Request</i> message. Now obsolete.	792
	17	<i>Address Mask Request</i>	Used to request that a device send a subnet mask.	950
	18	<i>Address Mask Reply</i>	Contains a subnet mask sent in reply to an <i>Address Mask Request</i> .	950
	30	<i>Traceroute</i>	Used to implement the experimental “enhanced” <i>traceroute</i> utility.	1393
ICMPv6 Error Messages	1	<i>Destination Unreachable</i>	Indicates that a datagram could not be delivered to its destination. <i>Code</i> value provides more information on the nature of the error.	2463
	2	<i>Packet Too Big</i>	Sent when a datagram cannot be forwarded because it is too big for the maximum transmission unit (MTU) of the next hop in the route. This message is needed in IPv6 and not IPv4 because in IPv4, routers can fragment oversized messages, while in IPv6 they cannot.	2463
	3	<i>Time Exceeded</i>	Sent when a datagram has been discarded prior to delivery due to the <i>Hop Limit</i> field being reduced to zero.	2463
	4	<i>Parameter Problem</i>	Indicates a miscellaneous problem (specified by the <i>Code</i> value) in delivering a datagram.	2463
ICMPv6 Informational Messages	128	<i>Echo Request</i>	Sent by a device to test connectivity to another device on the internetwork.	2463
	129	<i>Echo Reply</i>	Sent in reply to an <i>Echo (Request)</i> message; used for testing connectivity.	2463
	133	<i>Router Solicitation</i>	Prompts a router to send a <i>Router Advertisement</i> .	2461
	134	<i>Router Advertisement</i>	Sent by routers to tell hosts on the local network the router exists and describe its capabilities.	2461
	135	<i>Neighbor Solicitation</i>	Sent by a device to request the layer two address of another device while providing its own as well.	2461
	136	<i>Neighbor Advertisement</i>	Provides information about a host to other devices on the network.	2461
	137	<i>Redirect</i>	Redirects transmissions from a host to either an immediate neighbor on the network or a router.	2461
	138	<i>Router Renumbering</i>	Conveys renumbering information for router renumbering.	2894

You can see that several of the message types are quite similar in ICMPv4 and ICMPv6, but there are some slight differences. An obvious one is that *Redirect* is considered an error message in ICMPv4, but an informational message in ICMPv6. The way that the messages is used also often different. In IPv6, the use of many of the ICMP informational messages is described in the [Neighbor Discovery \(ND\) protocol](#), which is new to IPv6.

Note that the *Information Request* and *Information Reply* messages were originally created to allow devices to determine an IP address and possibly other configuration information. This function was later implemented using protocols such as [RARP](#), [BOOTP](#) and [DHCP](#), and these message types obsoleted.

ICMP Message Creation and Processing Conventions and Rules

In [the overview of ICMP](#) I compared the relationship between IP and ICMP to that between an executive and an administrative assistant. One of the characteristics that many executives value in a good assistant is that the assistant does his or her work independently, and without causing unnecessary disruption. A good assistant should save the executive time, not cost him or her time.

As the “assistant” to IP, ICMP must similarly help IP function without taking up too much of its “time”. Here, the resource being conserved is not so much “time” as **bandwidth**. ICMP messages are important, but must be considered part of the “overhead” of running a network. They carry no user data, so each one represents a small loss of overall end-user bandwidth on the network. For this reason, we want to send them only when necessary, and to carefully control the circumstances under which they are generated.

Now, administrative assistants have some serious advantages over networking protocols: common sense and experience. They usually know where the line is drawn between help and hindrance; computers don't. To partially compensate, ICMP's operation is guided by a set of *conventions* or *rules* for how messages are created and processed. For ICMPv4, these conventions are described in part in the defining RFC 792, but much more in RFC 1122 ([Requirements for Internet Hosts — Communication Layers](#)), which provides specific information on implementing TCP/IP in host devices. In ICMPv6, the information related to ICMP implementation that appears in RFC 1122 has been largely incorporated into the main document that defines ICMPv6, RFC 2463.

Limitations on ICMP Message Responses

Most of the issues related to message generation have to do with error messages, not informational messages. The latter class of messages usually don't cause problems because they are generated based on specific rules already established in the protocols that use them. For example, *Router Advertisement* messages are sent by routers on a regular basis, and the routers make sure this is infrequent. They are also sent in response to *Router Solicitation* messages sent on occasion by hosts, and as long as a host doesn't go haywire and start sending tons of *Solicitations*, there won't be a problem. Even then, a router can be given enough smarts not to send *Router Advertisements* too often.

The problem comes up with error messages specifically because they are sent *in response* to so many situations. Potentially, they may even be sent in response to each other. Without special care, loops or cascading message generation might occur. For example, consider a situation where device *A* encounters an error and sends an error report to device *B*. Device *B* finds an error in device *A*'s message and sends an error report back to device *A*. This could result in billions of messages being sent back and forth clogging the network, until a human figures out what is wrong and fixes it.

To prevent such problems, an ICMP error message **must not** be generated in response to any of the following:

- 🕒 **An ICMP Error Message:** This prevents loops of the type just mentioned. Note, however, that an ICMP error message **can** be generated in response to an ICMP informational message.
- 🕒 **A Broadcast or Multicast Datagram:** What would happen if a datagram were broadcast to 5,000 hosts and each of them found an error in it and tried to send a report back to the source? Something unpleasant.
- 🕒 **IP Datagram Fragments Except The First:** When a datagram is [fragmented](#), errors may only be sent in response to the first fragment. Often, errors that are generated due to a problem with one fragment would also be generated by each successive one, causing unnecessary ICMP traffic.
- 🕒 **Datagrams With Non-Unicast Source Address:** If a datagram's source address doesn't define a unique, unicast device address, an error message cannot be sent back to that source. This prevents ICMP messages from being broadcast, unicast, or sent to non-routable special addresses such as the [loopback address](#).



Key Concept: In order to prevent excessive numbers of ICMP messages from being sent on a network, a special set of rules is put into place to govern when and how they may be created. Most of these are designed to eliminate situations where very large numbers of ICMP error messages would be generated in response to certain occurrences.

These rules apply to both ICMPv4 and ICMPv6, but in ICMPv6 there are a couple of special cases. In certain circumstances an ICMPv6 *Packet Too Big* message may be sent to a multicast address, as this is required for [Path MTU Discovery](#) to work. Certain *Parameter Problem* messages may also be sent to multicast or broadcast addresses. Finally, in addition to the rules above, IPv6 implementations are specifically directed to limit the rate at which they send ICMPv6 messages overall.

ICMP Message Processing Conventions

Message processing generally takes place as described in [the topic on general operation](#), with the ICMP message delivered either to the IP software or other protocol software implementation as required. What is done with the message usually depends on its type. Some are destined only for the IP software itself, but many are intended for the higher-layer

protocol that generated the datagram that led to the error. [In the next topic](#) we will see that ICMP error messages include information that allows the upper-layer protocol to be extracted for the purpose of passing the message to the appropriate software layer.

In IPv6, the class of message (error or informational) can be determined from the *Type* value. This knowledge can then be used to guide processing of ICMP messages with unknown *Type* values. The rule is that ICMP error messages with unknown *Type* values must be passed to the appropriate upper layer protocol. Informational messages with unknown *Type* values are discarded without taking action.

In addition to these general rules, there are specific rules put into place to guide the processing of some of the message types. I describe some of these conventions in the topics that discuss individual ICMP messages.

An important final point is that ICMP messages, especially error messages, are not considered "binding" on the device that processes them. To stick with the office analogy, they have the equivalent status in an office of only of an "FYI memo", not an "assignment". It is often the case that a device **should** take action upon processing an ICMP message, but the device is not required to. The exception, again, is when informational messages are used for specific purposes. For example, most of the messages that come in pairs are designed so that a *Request* results in the matching *Reply* and a *Solicitation* yields an *Advertisement*.



Key Concept: A device receiving an ICMP message is not required to take action unless a protocol using a message type dictates a specific response to a particular message type. In particular, devices are not mandated to perform any specific task when receiving an ICMP error message.

ICMP Common Message Format and Data Encapsulation

As we have seen in the preceding topics, ICMP is not so much a protocol that performs a specific function as a [framework for the exchange of error reports and information](#). Since each of the message types is used for a different purpose, they differ in the types of information each contains. This means each ICMP message has a slightly different format. At the same time, however, ICMP message types also have a degree of commonality—a portion of each message is common between message types.

ICMP Common Message Format

The structure of an ICMP message can be generally thought of as having a *common part* and a *unique part*. The common part consists of three fields that have the same size and same meaning in all ICMP messages (though the values in the fields aren't the same for each ICMP message type, of course). The unique part contains fields that are specific to each type of message.

Interestingly, the common message format is basically the same for ICMPv4 and ICMPv6. It is described in [Table 88](#) and [Figure 138](#).

Table 88: ICMP Common Message Format

Field Name	Size (bytes)	Description
Type	1	Type: Identifies the ICMP message type. For ICMPv6, values from 0 to 127 are error messages and values 128 to 255 are informational messages. Common values for this field are given in the table in the topic on ICMP message classes and types .
Code	1	Code: Identifies the “subtype” of message within each ICMP message Type value. Thus, up to 256 “subtypes” can be defined for each message type. Values for this field are shown in the individual ICMP message type topics .
Checksum	2	Checksum: 16-bit checksum field that is calculated in a manner similar to the IP header checksum in IPv4 . It provides error detection coverage for the entire ICMP message. Note that in ICMPv6, a pseudo-header of IPv6 header fields is prepended for checksum calculation; this is similar to the way this is done in TCP .
Message Body / Data	Variable	Message Body: Contains the specific fields used to implement each message type. This is the unique part of the message as I mentioned above.

The message body typically contains one or several fields that carry information of relevance to each specific type of ICMP message. For error messages, we see here one more area of commonality in ICMP messages: all ICMP error messages include a portion of the original IP datagram that led to the ICMP error message. This aids in diagnosing the problem that caused the ICMP message to be generated, by allowing the error to be communicated to higher layers.

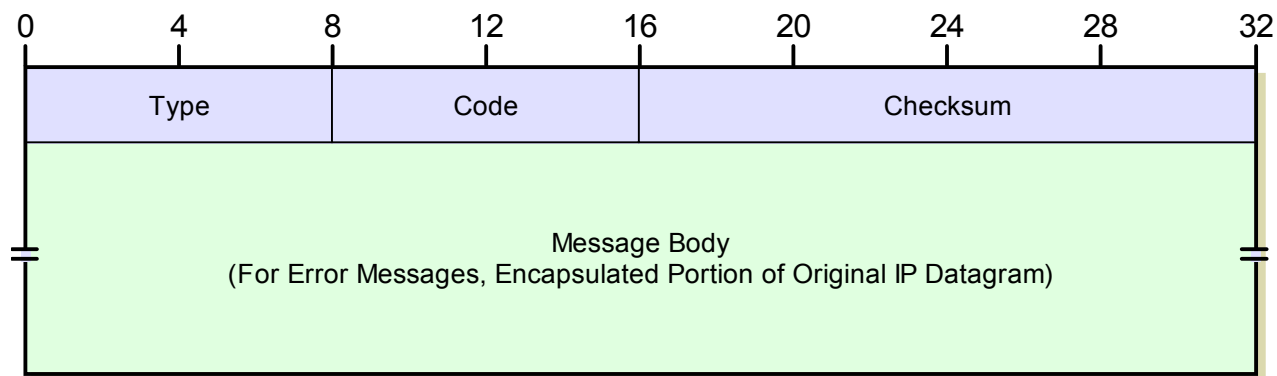

Figure 138: ICMP Common Message Format

This overall, generic message format is used for both ICMPv4 and ICMPv6 message types.

Original Datagram Inclusion In ICMP Error Messages

The inclusion of original IP datagram information is done differently for the two ICMP versions.

ICMPv4 Error Messages

Each error message includes the full IP header and the first 8 bytes of the payload. Since the beginning of the payload will contain the encapsulated higher-layer header, this means the ICMP message also carries either the full UDP header, or the first 8 bytes of the TCP header. In both cases, the [source and destination port numbers](#) are part of what is included.

If the original header was a standard IP header with no options, the *Message Body* will therefore have a length of 28 bytes; if options are present, it will be larger.

ICMPv6 Error Messages

Each error message includes as much of the IPv6 datagram as will fit without causing the size of the ICMPv6 error message (including its IP header encapsulation) to exceed the [minimum IPv6 maximum transmission unit size](#), which is 1280 bytes. This provides additional information for diagnostic purposes compared to ICMPv4, while ensuring that no ICMPv6 error messages will be too large for any physical network segment. The larger size of the included data allows the IPv6 extension headers to be included in the error message, since the error could be in one of those extension headers.

Remember that [in IPv6, routers cannot fragment IP datagrams](#); any datagram that is “oversized” for an underlying physical network is dropped. ICMPv6 is thus designed to ensure that this does not happen by not creating ICMPv6 datagrams over the universal IPv6 MTU size of 1280.



Key Concept: Each kind of ICMP message contains data unique to that message type, but all messages are structured according to a common ICMP message format. ICMP error messages always include in their message body field some portion of the original IP datagram that resulted in the error being generated.

ICMP Data Encapsulation

After an ICMP message is formatted, it is [encapsulated in an IP datagram](#) like any other IP message. This is why some people believe ICMP is architecturally a higher layer than IP, though as we discussed earlier it is really more of a special case. You can also see then, that when an ICMP error message is generated, we end up with the original IP header and part or all of the payload, encapsulated in the ICMP message, in turn encapsulated within a new IP header to be sent back as an error report usually to the device that sent the original IP message.



ICMP Message Types and Formats

The Internet Control Message Protocol (ICMP) provides a mechanism for error reporting and the exchange of important information between IP devices. Many different message types exist within ICMP, which have certain common attributes that we saw in [the section discussing ICMP generalities](#). Beyond these commonalities, the details of how ICMP messages are created and used diverge based on the specific message type, so it's time to look at these and see how they work.

In this section I provide specific details on the most commonly-seen ICMP message types, including a description of both their use and their specific message formats. There are 20 different message types currently covered, so they have been divided into four subsections for better organization. These correspond to the four combinations of ICMP version (ICMPv4 and ICMPv6) and message class (error and informational).



Related Information: For a cross-reference of message types and corresponding ICMP *Type* field values, [see the general topic on ICMP message classes and types](#). For more information on the “common” ICMP message format fields (*Type*, *Code* and *Checksum*) and incorporation of original IP datagram information in error messages, [see the topic on ICMP Common Message Format and Data Encapsulation](#).

ICMP Version 4 (ICMPv4) Error Message Types and Formats

ICMP error messages are used by routers and hosts to tell a device that sent a datagram about problems encountered in delivering it. In the original ICMP version 4, five different error messages are defined, which are all described in the original ICMP standard, RFC 792. These are some of the most important ICMP messages, since they provide critical feedback about error conditions and may help a transmitting device take corrective action to ensure reliable and efficient datagram delivery.

In this first of four sections on specific ICMP types, I look at the ICMPv4 error messages. I begin with *Destination Unreachable* messages, which are sent due to datagram delivery failures, and *Source Quench* messages, used to tell a device to slow down the rate at which it sends datagrams. Next I describe *Time Exceeded* messages, sent when a datagram has been traveling the network too long or takes too long to be reassembled from fragments, and *Redirect* messages, which let a router provide feedback about better routes to a host. Finally, I discuss *Parameter Problem* messages, a generic “catch all” type used for problems not covered by other ICMP error messages.

ICMPv4 Destination Unreachable Messages

Since the Internet Protocol is an [unreliable protocol](#), there are no guarantees that a datagram sent by one device to another will ever actually get there. The internetwork of hosts and routers will make a “best effort” to deliver the datagram but it may not get where it needs to for any number of reasons. Of course, devices on an IP network understand that and are designed accordingly. IP software never assumes its datagrams will always be received, and higher layer protocols like [TCP](#) take care of [providing reliability and acknowledgements](#) of received data for applications that need these features.

This setup, with higher layers handling failed deliveries, is sufficient in some cases. For example, suppose device *A* tries to send to device *B*, but a router near *B* is overloaded, so it drops the datagram. In this case the problem is likely intermittent, so *A* can retransmit and eventually reach *B*. But what about a situation where a device is trying to send to an IP address that doesn't exist, or a problem with routing that isn't easily corrected? Having the source just continually retry while it remains “in the dark” about the problem would be inefficient, to say the least.

So in general, while IP is designed to allow IP datagram deliveries to fail, we should take any such failures seriously. What we really need is a feedback mechanism that can tell a source device that something improper is happening, and why. In IPv4, this service is provided through the transmission of *Destination Unreachable* ICMP messages. When a source node receives one of these messages it knows there was a problem sending a datagram, and can then decide what action, if any, it wants to take. Like all ICMP error messages, *Destination Unreachable* messages include a portion of the datagram that could not be delivered, which helps the recipient of the error figure out what the problem is.

ICMPv4 Destination Unreachable Message Format

Table 89 and Figure 139 show the specific format for ICMPv4 *Destination Unreachable* messages.

Table 89: ICMPv4 Destination Unreachable Message Format

Field Name	Size (bytes)	Description
Type	1	Type: Identifies the ICMP message type; for <i>Destination Unreachable</i> messages this is set to 3.
Code	1	Code: Identifies the “subtype” of unreachable error being communicated. See Table 90 for a full list of codes and what they mean.
Checksum	2	Checksum: 16-bit checksum field for the ICMP header, as described in the topic on the ICMP common message format.
Unused	4	Unused: 4 bytes that are left blank and not used.
Original Datagram Portion	Variable	Original Datagram Portion: The full IP header and the first 8 bytes of the payload of the datagram that prompted this error message to be sent.

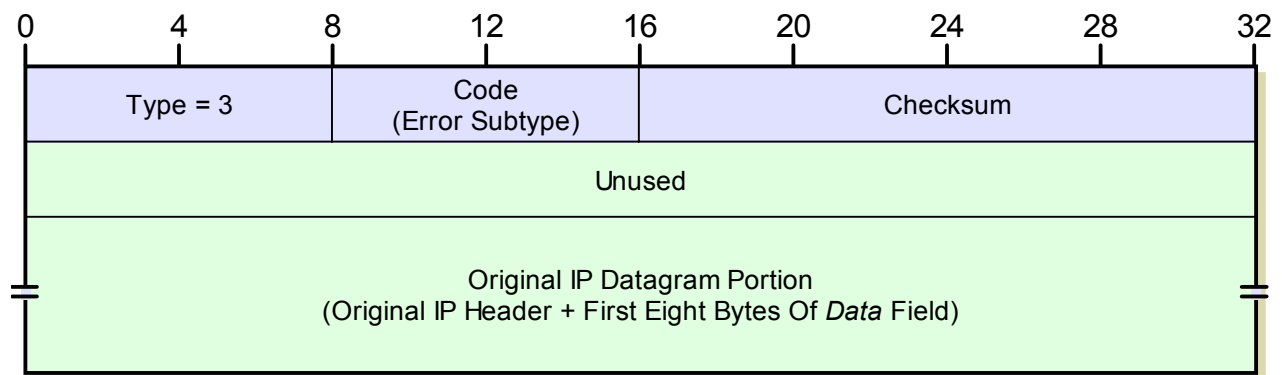

Figure 139: ICMPv4 Destination Unreachable Message Format

ICMPv4 Destination Unreachable Message Subtypes

There are many different reasons why it may not be possible for a datagram to reach its destination. Some of these may be due to erroneous parameters (like the invalid IP address example mentioned above.) A router might have a problem reaching a particular network for whatever reason. There can also be other more “esoteric” reasons as well why a datagram cannot be delivered.

For this reason, the ICMPv4 *Destination Unreachable* message type can really be considered a class of related error messages. The receipt of a *Destination Unreachable* message tells a device that the datagram it sent couldn't be delivered, and the reason for the non-delivery is indicated by the *Code* field in the ICMP header. [Table 90](#) shows the different *Code* values, corresponding message subtypes and a brief explanation of each.

Table 90: ICMPv4 *Destination Unreachable* Message Subtypes (Page 1 of 2)

Code Value	Message Subtype	Description
0	Network Unreachable	The datagram could not be delivered to the network specified in the network ID portion of the IP address. Usually means a problem with routing but could also be caused by a bad address.
1	Host Unreachable	The datagram was delivered to the network specified in the network ID portion of the IP address but could not be sent to the specific host indicated in the address. Again, this usually implies a routing issue.
2	Protocol Unreachable	The protocol specified in the Protocol field was invalid for the host to which the datagram was delivered.
3	Port Unreachable	The destination port specified in the UDP or TCP header was invalid.
4	Fragmentation Needed and DF Set	<p>This is one of those “esoteric” codes. ☺ Normally, an IPv4 router will automatically fragment a datagram that it receives if it is too large for the maximum transmission unit (MTU) of the next physical network link the datagram needs to traverse. However, if the <i>DF (Don't Fragment)</i> flag is set in the IP header, this means the sender of the datagram does not <i>want</i> the datagram ever to be fragmented. This puts the router between the proverbial rock and hard place, and it will be forced to drop the datagram and send an error message with this code.</p> <p>This message type is most often used in a “clever” way, by intentionally sending messages of increasing size to discover the maximum transmission size that a link can handle. This process is called MTU path discovery.</p>
5	Source Route Failed	Generated if a source route was specified for the datagram in an option but a router could not forward the datagram to the next step in the route.
6	Destination Network Unknown	Not used; Code 0 is used instead.
7	Destination Host Unknown	The host specified is not known. This is usually generated by a router local to the destination host and usually means a bad address.
8	Source Host Isolated	Obsolete, no longer used.
9	Communication with Destination Network is Administratively Prohibited	The source device is not allowed to send to the network where the destination device is located.
10	Communication with Destination Host is Administratively Prohibited	The source device is allowed to send to the network where the destination device is located, but not that particular device.

Table 90: ICMPv4 Destination Unreachable Message Subtypes (Page 2 of 2)

Code Value	Message Subtype	Description
11	Destination Network Unreachable for Type of Service	The network specified in the IP address cannot be reached due to inability to provide service specified in the <i>Type Of Service</i> field of the datagram header.
12	Destination Host Unreachable for Type of Service	The destination host specified in the IP address cannot be reached due to inability to provide service specified in the datagram's <i>Type Of Service</i> field.
13	Communication Administratively Prohibited	The datagram could not be forwarded due to filtering that blocks the message based on its contents.
14	Host Precedence Violation	Sent by a first-hop router (the first router to handle a sent datagram) when the <i>Precedence</i> value in the <i>Type Of Service</i> field is not permitted.
15	Precedence Cutoff In Effect	Sent by a router when receiving a datagram whose <i>Precedence</i> value (priority) is lower than the minimum allowed for the network at that time.

As you can see in that table, not all of these codes are actively used at this time. For example, code 8 is obsolete and code 0 is used instead of 6. Also, some of the higher numbers related to the *Type Of Service* field aren't actively used because *Type Of Service* isn't actively used.



Key Concept: ICMPv4 *Destination Unreachable* messages are used to inform a sending device of a failure to deliver an IP datagram. The message's *Code* field provides information about the nature of the delivery problem.

Interpretation of Destination Unreachable Messages

Finally, it's important to remember that just as IP is "best effort", the reporting of unreachable destinations using ICMP is also "best effort". For one thing, these ICMP messages are themselves carried in IP datagrams. More than that, however, one must remember that there may be problems that prevent a router from detecting failure of delivery of an ICMP message, such as a low-level hardware problem. A router could, theoretically, also be precluded from sending an ICMP message even when failure of delivery *is* detected, for whatever reason.

For this reason, the sending of *Destination Unreachable* messages should be considered **supplemental**. There is no guarantee that every problem sending a datagram will result in a corresponding ICMP message. No device should count on receiving an ICMP *Destination Unreachable* for a failed delivery any more than it counts on the delivery in the first place. This is why the higher-layer mechanisms mentioned at the start of this topic are still important.

ICMPv4 Source Quench Messages

When a source device sends out a datagram, it will travel across the internetwork and eventually arrive at its intended destination—hopefully. At that point, it is up to the destination device to process the datagram, by examining it and determining which higher-layer software process to hand the datagram.

If a destination device is receiving datagrams at a relatively slow rate, it may be able to process each datagram “on the fly” as it is received. However, datagram receipt in a typical internetwork can tend to be uneven or “bursty”, with alternating higher and lower rates of traffic. To allow for times when datagrams are arriving faster than they can be processed, each device has a *buffer* where it can temporarily hold datagrams it has received until it has a chance to deal with them.

However, this buffer is itself limited in size. Assuming the device has been properly designed, the buffer may be sufficient to smooth out high-traffic and low-traffic periods most of the time. Certain situations can still arise in which traffic is received so rapidly that the buffer itself fills up entirely. Some examples of scenarios in which this might happen include:

- ☉ A single destination is overwhelmed by datagrams from many sources, such as a popular Web site being swamped by HTTP requests.
- ☉ Device *A* and device *B* are exchanging information but device *A* is a much faster computer than device *B* and can generate outgoing and process incoming datagrams much faster than *B* can.
- ☉ A router receives a large number of datagrams over a high-speed link that it needs to forward over a low-speed link; they start to pile up while waiting to be sent over the slow link.
- ☉ A hardware failure or other situation causes datagrams to sit at a device unprocessed.

A device that continues to receive datagrams when it has no more buffer space is forced to discard them, and is said to be *congested*. A source that has its datagram discarded due to congestion won't have any way of knowing this, since IP itself is unreliable and unacknowledged. Therefore, while it is possible to simply allow higher-layer protocols to detect the dropped datagrams and generate replacements, it makes a lot more sense to have the congested device provide feedback to the sources, telling them that it is overloaded.

In IPv4, a device that is forced to drop datagrams due to congestion provides feedback to the sources that overwhelmed it by sending them ICMPv4 *Source Quench* messages. Just as we use water to quench a fire, a *Source Quench* method is a signal that attempts to quench a source device that is sending too fast. In other words, it's a polite way for one IP device to tell another: “SLOW DOWN!” When a device receives one of these messages it knows it needs to cut down on how fast it is sending datagrams to the device that sent it.

ICMPv4 Source Quench Message Format

The specific format for ICMPv4 *Source Quench* messages can be found in [Table 91](#) and [Figure 140](#).

Table 91: ICMPv4 Source Quench Message Format

Field Name	Size (bytes)	Description
Type	1	Type: Identifies the ICMP message type; for <i>Source Quench</i> messages this is set to 4.
Code	1	Code: Identifies the “subtype” of error being communicated. For <i>Source Quench</i> messages this is not used, and the field is set to 0.
Checksum	2	Checksum: 16-bit checksum field for the ICMP header, as described in the topic on the ICMP common message format .
Unused	4	Unused: 4 bytes that are left blank and not used.
Original Datagram Portion	Variable	Original Datagram Portion: The full IP header and the first 8 bytes of the payload of the datagram that was dropped due to congestion.

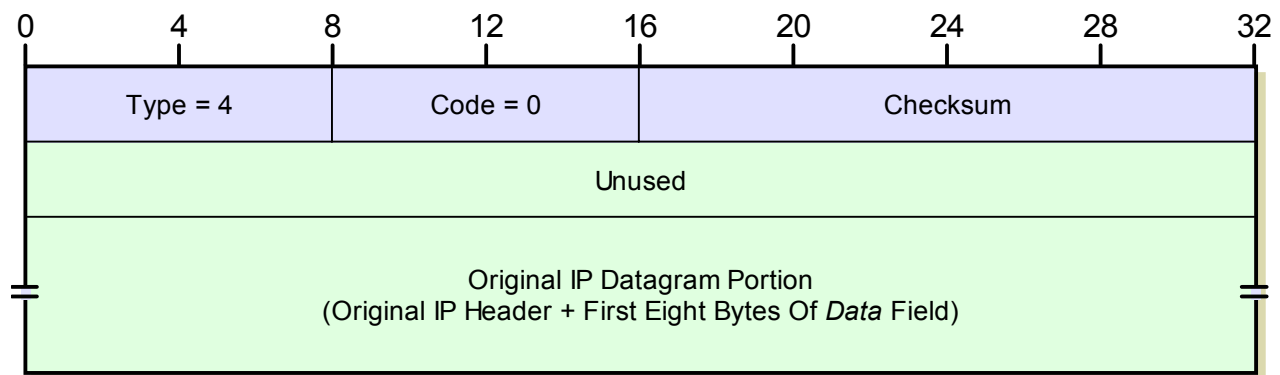

Figure 140: ICMPv4 Source Quench Message Format

Problems With Source Quench Messages

What's interesting about the *Source Quench* format is that it is basically a “null message”. It tells the source that the destination is congested but provides no specific information about that situation, nor does it specify what exactly the destination wants the source to do, other than to cut back on its transmission rate in some way. There is also no method for the destination to signal a source it has “quenched” that it is no longer congested and to resume its prior sending rate. This means the response to a *Source Quench* is left up to the device that receives it. Usually, a device will cut back its transmission rate until it no longer receives the messages any more, and then may try to slowly increase the rate again.

In a similar manner, there are no rules about when and how a device generates *Source Quench* messages in the first place. A common convention is that one message is generated for each dropped datagram. However, more intelligent algorithms may be employed, specially on higher-end routers, to predict when the device's buffer will be filled and preemptively quench certain sources that are sending too quickly. Devices may also decide whether to quench all sources when they become busy, or only certain ones. As with other ICMP error messages, a device cannot count on a *Source Quench* being sent when one of its datagrams is discarded by a busy device.

The lack of information communicated in *Source Quench* messages makes them a rather crude tool for managing congestion. In general terms, the process of regulating the sending of messages between two devices is called *flow control*, and is usually a function of the transport layer. The [Transmission Control Protocol \(TCP\)](#) actually has a [flow control mechanism](#) that is far superior to the use of ICMP *Source Quench* messages.

Another issue with *Source Quench* messages is that they can be abused. Transmission of these messages by a malicious user can cause a host to be slowed down when there is no valid reason. This security issue, combined with the superiority of the TCP method for flow control, has caused *Source Quench* messages to largely fall out of favor.



Key Concept: ICMPv4 *Source Quench* messages are sent by a device to request that another reduce the rate at which it is sending datagrams. They are a rather crude method of flow control compared to more capable mechanisms such as that provided by TCP.

ICMPv4 Time Exceeded Messages

Large IP internetworks can have thousands of interconnected routers that pass datagrams between devices on various networks. In large internetworks, the topology of connections between routes can become complex, which makes routing more difficult. [Routing protocols](#) will normally allow routers to find the best routes between networks, but in some situations an inefficient route might be selected for a datagram.

In the worst case of inefficient routing, a *router loop* may occur. An example of this situation is where Router *A* thinks datagrams intended for network *X* should next go to Router *B*; Router *B* thinks they should go to Router *C*; and Router *C* thinks they need to go to Router *A*. ([See the ICMPv6 Time Exceeded Message description for an illustration of a router loop.](#))

If a loop like this occurred, datagrams for network *X* entering this part of the internet would circle forever, chewing up bandwidth and eventually leading to the network being unusable. As insurance against this occurrence, [each IP datagram includes in its header a *Time To Live \(TTL\)* field](#). This field was originally intended to limit the maximum time (in seconds) that a datagram could be on the internetwork, but now limits the life of a datagram by limiting the number of times the datagram can be passed from one device to the next. The

TTL is set to a value by the source that represents the maximum number of hops it wants for the datagram. Each router decrements the value; if it ever reaches zero the datagram is said to have *expired* and is discarded.

When a datagram is dropped due to expiration of the *TTL* field, the device that dropped the datagram will inform the source of this occurrence by sending it an ICMPv4 *Time Exceeded* message, as shown in Figure 141. Receipt of this message indicates to the original sending device that there is either a routing problem when sending to that particular destination, or that it set the *TTL* field value too low in the first place. As with all ICMP messages, the device receiving it must decide whether and how to respond to receipt of the message. For example, it may first try to re-send the datagram with a higher *TTL* value.

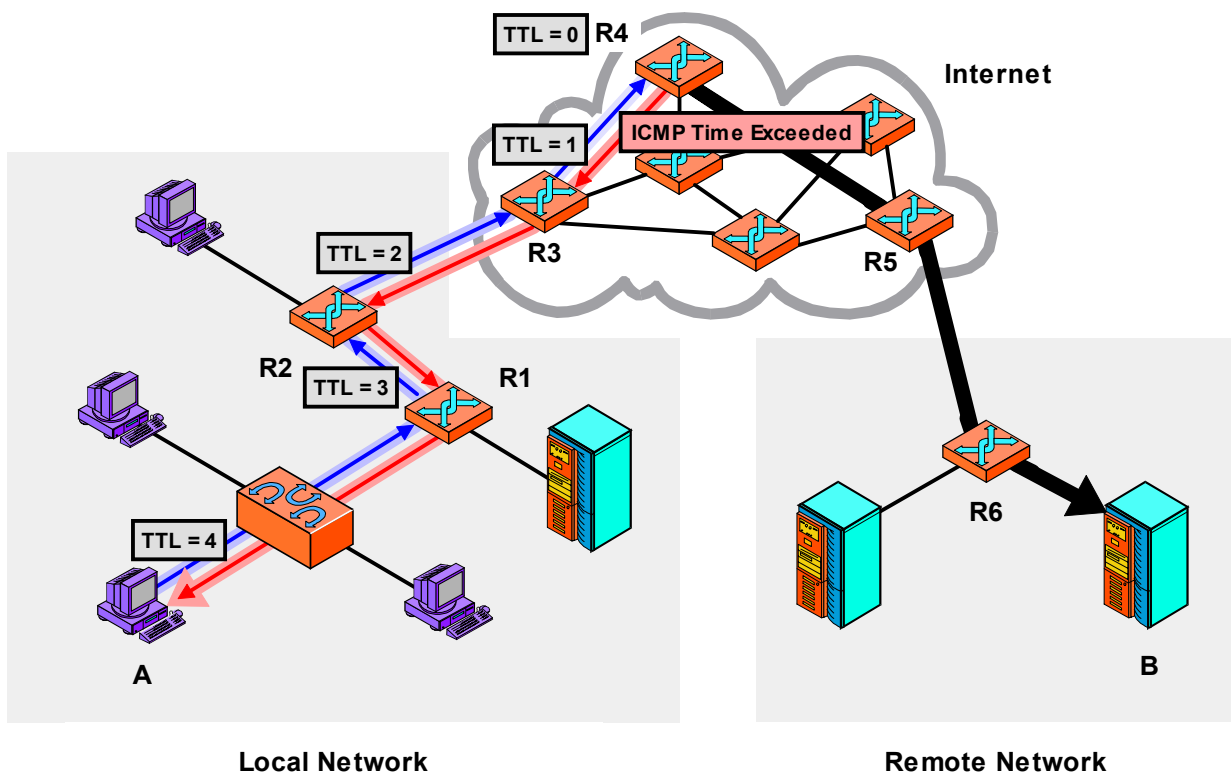

Figure 141: Expiration of an IP Datagram and *Time Exceeded* Message Generation

In this example, device A sends an IP datagram to device B that has a *Time To Live (TTL)* field value of only 4 (perhaps not realizing that B is 7 hops away). On the fourth hop the datagram reaches R4, which decrements its *TTL* field to zero and then drops it as expired. R4 then sends an ICMP *Time Exceeded* message back to A.

There is another “time expiration” situation where ICMP *Time Exceeded* messages are used. When an IP message is **broken into fragments**, the destination device is charged with **reassembling them into the original message**. One or more fragments may not make it to the destination, so to prevent the device from waiting forever, it sets a timer when the first fragment arrives. If this timer expires before the others are received, the device gives up on this message. The fragments are discarded, and a *Time Exceeded* message generated.

ICMPv4 Time Exceeded Message Format

Table 92 and Figure 142 show the specific format for ICMPv4 *Time Exceeded* messages.

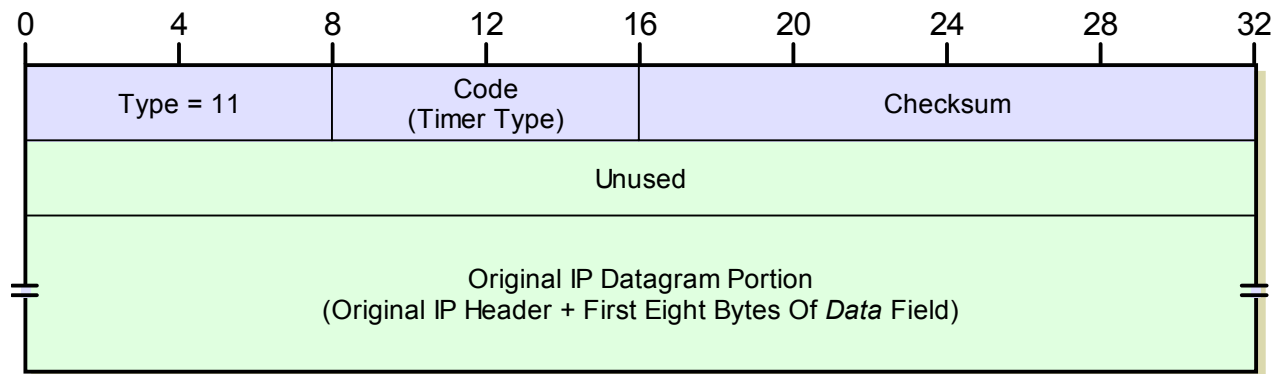

Figure 142: ICMPv4 *Time Exceeded* Message Format

Table 92: ICMPv4 *Time Exceeded* Message Format

Field Name	Size (bytes)	Description
Type	1	Type: Identifies the ICMP message type; for <i>Time Exceeded</i> messages this is set to 11.
Code	1	Code: Identifies the “subtype” of error being communicated. A value of 0 indicates expiration of the IP <i>Time To Live</i> field; a value of 1 indicates that the fragment reassembly time has been exceeded.
Checksum	2	Checksum: 16-bit checksum field for the ICMP header, as described in the topic on the ICMP common message format .
Unused	4	Unused: 4 bytes that are left blank and not used.
Original Datagram Portion	Variable	Original Datagram Portion: The full IP header and the first 8 bytes of the payload of the datagram that was dropped due to expiration of the <i>TTL</i> field or reassembly timer.

Applications of Time Exceeded Messages

As an ICMP error message type, ICMP *Time Exceeded* messages are usually sent in response to the two conditions described above (*TTL* or reassembly timer expiration). Generally, *Time To Live* expiration messages are generated by routers as they try to route a datagram, while reassembly violations are indicated by end hosts. However, there is actually a very clever application of these messages that has nothing to do with reporting errors at all.



Key Concept: ICMPv4 *Time Exceeded* messages are sent in two different “time-related” circumstances. The first is if a datagram’s *Time To Live (TTL)* field is reduced to zero, causing it to expire and the datagram to be dropped. The second is when all the pieces of a fragmented message are not received before the expiration of the recipient’s reassembly timer.

The TCP/IP *traceroute* (or *tracert*) utility is used to show the sequence of devices over which a datagram is passed on a particular route between a source and destination, as well as the amount of time it takes for a datagram to reach each hop in that route. This utility was originally implemented using *Time Exceeded* messages by sending datagrams with successively higher *TTL* values. First, a “dummy” datagram is sent with a *TTL* value of 1, causing the first hop in the route to discard the datagram and send back an ICMP *Time Exceeded*; the time elapsed for this could be measured. Then, a second datagram is sent with a *TTL* value of 2, causing the second device in the route to report back a *Time Exceeded*, and so on. By continuing to increase the *TTL* value we can get reports back from each hop in the route. [See the topic describing traceroute for more details on its operation.](#)

ICMPv4 Redirect Messages

Every device on an internetwork needs to be able to send to every other device. If hosts were responsible for determining the routes to each possible destination, each host would need to maintain an extensive set of routing information. Since there are so many hosts on an internetwork, this would be a very time-consuming and maintenance-intensive situation.

Instead, IP internetworks are designed around a fundamental design decision: routers are responsible for [determining routes and maintaining routing information](#). Hosts only determine when they need a datagram routed, and then hand the datagram off to a local router to be sent where it needs to go. [I discuss this in more detail in my overview of IP routing concepts.](#)

Since most hosts do not maintain routing information, they must rely on routers to know about routes and where to send datagrams intended for different destinations. Typically, a host on an IP network will start out with a routing table that basically tells it to send everything not on the local network to a single *default router*, which will then figure out what to do with it. Obviously if there is only one router on the network, the host will use that as the default router for all non-local traffic. However, if there are two or more routers, sending all datagrams to just one router may not make sense. It is possible that a host could be manually configured to know which router to use for which destinations, but another mechanism in IP can allow a host to learn this automatically.

Consider a network *N1* that contains a number of hosts (*H1*, *H2*, etc...) and two routers, *R1* and *R2*. Host *H1* has been configured to send all datagrams to *R1*, as its default router. Suppose it wants to send a datagram to a device on a different network (*N2*). However, *N2* is most directly connected to *N1* using *R2* and **not** *R1*. The datagram will first be sent to *R1*.

R1 will look in its routing table and see that datagrams for *N2* need to be sent through *R2*. “But wait,” *R1* says. “*R2* is on the local network, and *H1* is on the local network—so why am I needed as a middleman? *H1* should just send datagrams for *N2* directly to *R2* and leave me out of it.”

In this situation, *R1* will send an ICMPv4 *Redirect* message back to *H1*, telling it that in the future it should send this type of datagram directly to *R2*. This is shown in [Figure 143](#). *R1* will of course also forward the datagram to *R2* for delivery, since there is no reason to drop the datagram. Thus, despite usually being grouped along with true ICMP error messages, *Redirect* messages are really arguably not error messages at all; they represent a situation only where an inefficiency exists, not an outright error. (In fact, in [ICMPv6](#) they have been reclassified.)

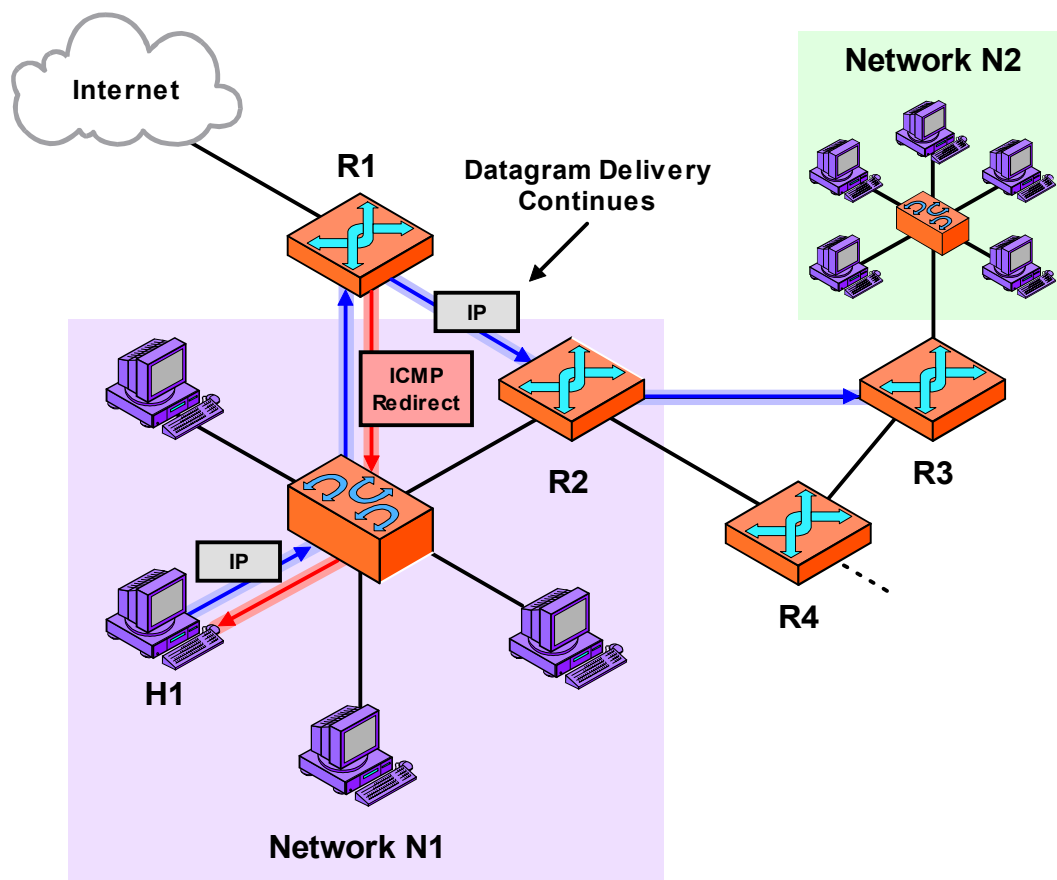

Figure 143: Host Redirection Using an ICMP *Redirect* Message

In this example *H1* sends to *R1* a datagram destined for network *N2*. However, *R1* notices that *R2* is on the same network and is a more direct route to *N2*. It forwards the datagram on to *R2* but also sends an ICMP *Redirect* message back to *H1* to tell it to use *R2* next time.

ICMPv4 Redirect Message Format

The format for ICMPv4 *Redirect* messages can be found in [Table 93](#) and [Figure 144](#).

Table 93: ICMPv4 Redirect Message Format

Field Name	Size (bytes)	Description
Type	1	Type: Identifies the ICMP message type; for <i>Redirect</i> messages this value is 5.
Code	1	Code: Identifies the meaning or “scope” of the <i>Redirect</i> message. See Table 94 for an explanation of how this field is used in <i>Redirect</i> messages.
Checksum	2	Checksum: 16-bit checksum field for the ICMP header, as described in the topic on the ICMP common message format .
Internet Address	4	Internet Address: The address of the router to which future datagrams sent to the original destination should be sent.
Original Datagram Portion	Variable	Original Datagram Portion: The full IP header and the first 8 bytes of the payload of the datagram that led to the creation of the <i>Redirect</i> .

Redirect Message Interpretation Codes

When a *Redirect* is received back by a device, it inspects the included portion of the original datagram. Since this contains the original destination address of the redirected target device, this tells the original sender which addresses should be redirected in the future. The *Internet Address* field tells it what router it should use for subsequent datagrams. The *Code* field tells the sender how broadly to interpret the redirection. There are four different *Code* values; see [Table 94](#).

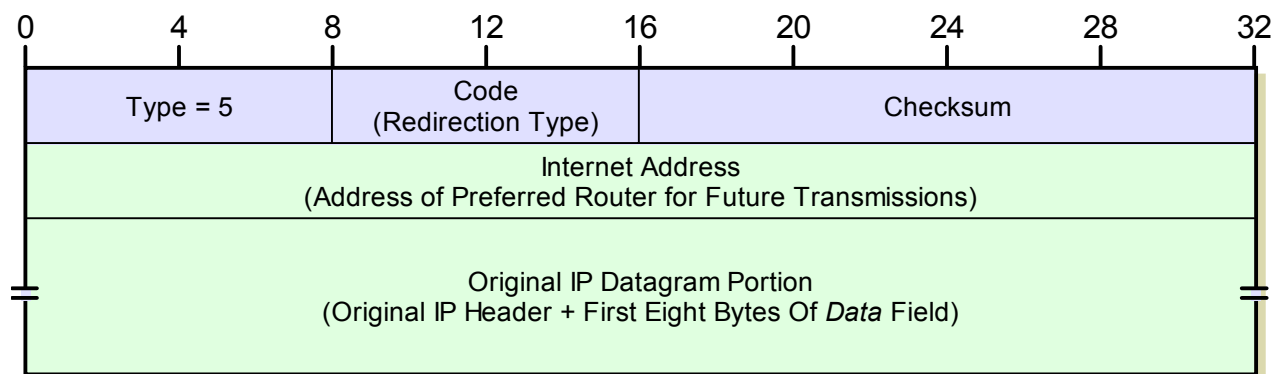

Figure 144: ICMPv4 Redirect Message Format

Obviously, routers usually generate *Redirect* messages and send them to hosts; hosts do not normally create them. The specific rules for when *Redirects* are created can be fairly complex, as a number of conditions may exist that preclude these messages from being sent. In particular, special rules exist for when a router may *Redirect* an entire network (or

subnet) instead of just a single host. Also, remember that the *Type Of Service* field is optional and often not used, so *Redirects* with *Code* values of 2 or 3 are less common than those with values of 0 and 1.

Table 94: ICMP *Redirect* Message Interpretation Codes

Code Value	Message Subtype	Meaning
0	<i>Redirect Datagrams For The Network (Or Subnet)</i>	Redirect all future datagrams sent not only to the device whose address caused this <i>Redirect</i> , but also datagrams sent to all other devices on the network (or subnet) where that device is located. (This code is now obsolete; see the note that follows this table.)
1	<i>Redirect Datagrams For The Host</i>	Redirect all future datagrams only for the address of the specific device to which the original datagram was sent.
2	<i>Redirect Datagrams For The Type Of Service (TOS) and Network (Or Subnet)</i>	As for <i>Code</i> value 0, but only for future datagrams that have the same <i>Type Of Service (TOS)</i> value as the original datagram. (This code is now obsolete; see the note that follows this table.)
3	<i>Redirect Datagrams For The Type Of Service (TOS) and Host</i>	As for <i>Code</i> value 1, but only for future datagrams that have the same <i>Type Of Service (TOS)</i> value as the original datagram.



Note: One problem with *Redirects* for whole networks is that the network specification may be ambiguous in an environment where subnetting or classless addressing are used. For this reason, the use of *Code* values 0 and 2 was prohibited by RFC 1812; they are considered obsolete on the modern Internet.

Limitations of Redirect Messages

I must emphasize that ICMP *Redirect* messages are **not** a mechanism by which the general routing process in IP is implemented; they are a support function only. They are a convenient way for hosts to be given information about routes by local routers, but are not used to communicate route information between routers.

This means that a *Redirect* can tell a host to use a more efficient first-hop router, but cannot tell a router to use a more efficient second-hop router. In our example above, suppose that in addition to the connections mentioned, *R2* is connected to *R3* and *R4* as shown in [Figure 143](#). *R2* sends the datagram in question to *R3*, which realizes it needs to send to *R4*, a router already directly connected to *R2*. *R3* **cannot** send a *Redirect* to *R2* telling it to use *R4* next time. The messages are simply not designed for this purpose—remember that ICMP messages always go back to the source of the original datagram, which would not be *R2* in this case. Such inefficiencies must be resolved using [routing protocols](#).



Key Concept: ICMPv4 *Redirect* messages are used by a router to inform a host of a preferred router to use for future datagrams sent to a particular host or network. They are not used to alter routes between routers.

ICMPv4 Parameter Problem Messages

The previous topics in this section describe four specific ICMPv4 message types that allow a device to report various error conditions to the original sender of a datagram. However, other error situations may arise also that don't correspond to any of these four specific message types. Typically, the problem results when a device attempts to process the header fields of an IP datagram and finds something in it that doesn't make sense.

If a device finds a problem with any of the parameters in an IP datagram header that is serious enough that it cannot complete processing the header, it must discard the datagram. Like other cases where a datagram must be tossed out, this is serious enough to warrant communication of the problem back to the device that sent the original datagram. This is accomplished in ICMPv4 using the *Parameter Problem* message type.

This is a “catch all” type of message that can be used to indicate an error in any header field of an IP datagram. The message type does not contain any specific fields or coding to indicate what the problem is. This was done intentionally to keep the *Parameter Problem* message “generic” and ensure that it could indicate any sort of error. Instead of special error codes, most *Parameter Problem* messages tell the original source which parameter caused the problem by including a special pointer that indicates which field in the original datagram header caused the problem.

ICMPv4 Parameter Problem Message Format

Table 95 and Figure 145 show the format for ICMPv4 *Parameter Problem* messages.

Table 95: ICMPv4 *Parameter Problem* Message Format

Field Name	Size (bytes)	Description
Type	1	Type: Identifies the ICMP message type; for <i>Parameter Problem</i> messages this value is 12.
Code	1	Code: Identifies the “subtype” of problem being communicated. See Table 96 for more information on this field for <i>Parameter Problem</i> messages.
Checksum	2	Checksum: 16-bit checksum field for the ICMP header, as described in the topic on the ICMP common message format.
Pointer	1	Pointer: An offset that points to the byte location in the datagram that caused the <i>Parameter Problem</i> message to be generated. The device receiving the ICMP message can use this value to get an idea of which field in the original message had the problem. This field is used only when the Code value is 0.

Table 95: ICMPv4 *Parameter Problem* Message Format

Field Name	Size (bytes)	Description
<i>Unused</i>	3	<i>Unused</i> : 3 bytes that are left blank and not used.
<i>Original Datagram Portion</i>	Variable	<i>Original Datagram Portion</i> : The full IP header and the first 8 bytes of the payload of the datagram that prompted this error message to be sent.

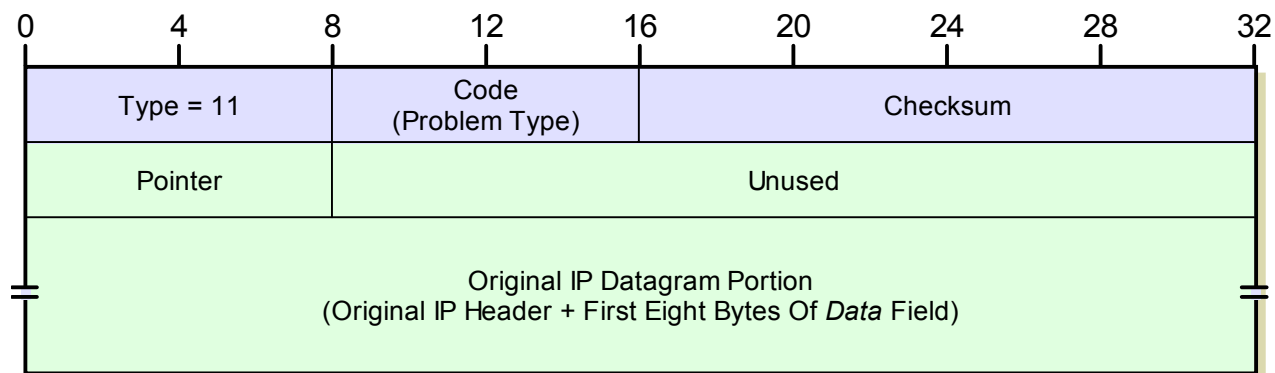

Figure 145: ICMPv4 *Parameter Problem* Message Format

Parameter Problem Message Interpretation Codes and The Pointer Field

When a *Parameter Problem* message is generated due to a specific bad field in the original message, the *Pointer* field is used as described above to show the location of the problem. This meaning of the *Parameter Problem* message is the one that was defined in the original ICMP standard, RFC 792, and is associated with *Code* value 0. There are some cases of a parameter problem where a pointer to a specific field in the original message really wouldn't make sense, so other standards have defined two new *Code* field values for *Parameter Problem* messages. [Table 96](#) shows the three *Code* values and provides a brief explanation of each.

Table 96: ICMPv4 *Parameter Problem* Message Interpretation Codes

Code Value	Message Subtype	Description
0	<i>Pointer Indicates The Error</i>	This is the normal use of the <i>Parameter Problem</i> message; when this <i>Code</i> value is used, the <i>Pointer</i> field indicates the location of the problem.
1	<i>Missing A Required Option</i>	The IP datagram needed to have an option in it that was missing. Since the option was missing there is no way to point to it, of course. ☺
2	<i>Bad Length</i>	The length of the datagram overall was incorrect, indicating a general problem with the message as a whole. Again, the <i>Pointer</i> field makes no sense here.



Key Concept: The ICMPv4 *Parameter Problem* message is a generic “catch all” that can be used to convey an error of any type in an IP datagram. A special *Pointer* field is normally used to indicate to the recipient of the message where the problem was in the original datagram.

Note that the *Pointer* field is only 8 bits wide, but since this allows for values up to 256 this is sufficient to allow it to point to any location within the IP header. It is possible for the *Pointer* field to point to a field within an IP option. Both hosts and routers can generate *Parameter Problem* messages.



ICMP Version 4 (ICMPv4) Informational Message Types and Formats

The five [ICMP error message types](#) communicate important information about error or problem conditions encountered during the operation of an IP internetwork. In contrast, the other class of ICMP messages contains those messages that are *informational*. They are not sent in response to some issue with a regular IP datagram, but are used on their own to implement various support functions for IP. Informational messages are used for testing and diagnostic purposes, as well as to let devices share critical information they need to function correctly.

In this section I describe nine different ICMP version 4 informational messages. Since many of these messages are used in functional sets, pairs of related messages are described in the same topic. I begin with a discussion of the *Echo (Request)* and *Echo Reply* messages used for network testing, and *Timestamp* and *Timestamp Reply* messages used for clock synchronization. I explain the use and format of *Router Advertisement* and *Router Solicitation* messages, which allow hosts to discover the identity of local routers and learn important information about them. I also describe the *Address Mask Request* and *Address Mask Reply* messages that communicate subnet mask information. I conclude with a look at the *Traceroute* message, which implements a more sophisticated version of the [traceroute utility](#).



Note: The original ICMP standard also defined two more informational message types: *Information Request* and *Information Reply*. These were intended to allow devices to determine an IP address and possibly other configuration information. This function was later implemented using protocols such as [RARP](#), [BOOTP](#) and [DHCP](#), and these message types obsoleted. Therefore, they are not discussed in this section. (Well, I guess I *did* just discuss them there... you know what I mean!)

ICMPv4 Echo (Request) and Echo Reply Messages

One of the main purposes of ICMP informational messages is to enable testing and diagnostics, to help identify and correct problems on an internetwork. The most basic test that can be conducted between two devices is simply checking if they are capable of sending datagrams to each other. The usual way that this is done is to have one device send a test message to a second device, which receives the message and replies back to tell the first device it received the message.

ICMPv4 includes a pair of messages specifically for connection testing. Suppose Device A wants to see if it can reach Device B. Device A begins the test process by sending an ICMPv4 *Echo* message to B. Device B, when it receives the *Echo*, responds back to Device A with an *Echo Reply* message. When Device A receives this message, it knows that it is able to communicate (both send and receive) successfully with Device B.



Note: The name of the first message in this pair is often given as *Echo Request*. While this does convey the paired nature of the *Echo* and *Echo Reply* messages, the formal name used in the standards is simply an *Echo* message.

ICMPv4 Echo and Echo Reply Message Format

Table 97 and Figure 146 show the format for both ICMPv4 *Echo* and *Echo Reply* messages.

Table 97: ICMPv4 Echo and Echo Reply Message Format

Field Name	Size (bytes)	Description
Type	1	Type: Identifies the ICMP message type. For <i>Echo</i> messages the value is 8; for <i>Echo Reply</i> messages the value is 0.
Code	1	Code: Not used for <i>Echo</i> and <i>Echo Reply</i> messages; set to 0.
Checksum	2	Checksum: 16-bit checksum field for the ICMP header, as described in the topic on the ICMP common message format .
Identifier	2	Identifier: An identification field that can be used to help in matching <i>Echo</i> and <i>Echo Reply</i> messages.
Sequence Number	2	Sequence Number: A sequence number to help in matching <i>Echo</i> and <i>Echo Reply</i> messages.
Optional Data	Variable	Optional Data: Additional data to be sent along with the message (not specified.)

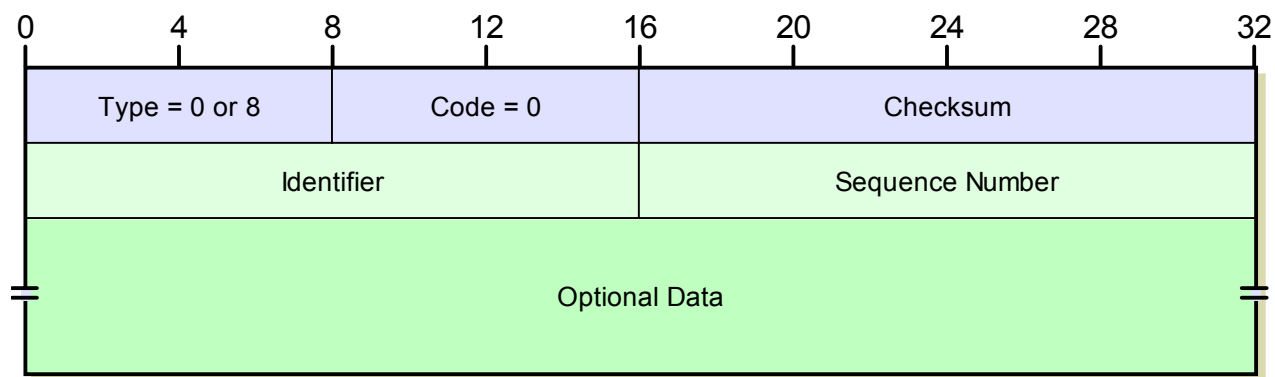

Figure 146: ICMPv4 Echo and Echo Reply Message Format

It is possible that a source device may want to send more than one *Echo* message to either a single destination or multiple destinations. Conversely, a single destination might receive *Echo* messages from more than one source. It is essential that a device receiving an *Echo Reply* knows which *Echo* prompted it to be sent.

Two special fields are used within the format of these messages to allow *Echo* and *Echo Reply* messages to be matched together, and to allow a sequence of messages to be exchanged. The *Identifier* field was envisioned as being used as a higher-level label, like a session identifier, while the *Sequence Number* was seen as something to identify individual test messages within a series. However, the use of these fields is up to the particular implementation. In some cases, the *Identifier* field is filled in with the process number of the application that is using the *Echo* or *Echo Reply* message, to allow several users to use utilities like ping without interference.

Application of Echo and Echo Reply Messages

The most common way that you may use the *Echo* and *Echo Reply* messages is through the popular utility *ping*, which is used to test host reachability. While the basic test simply consists of sending an *Echo* and waiting for an *Echo Reply*, modern versions of ping are quite sophisticated. They allow the user to specify many parameters, including the number of *Echo* messages sent, how often they are sent, the size of message transmitted and more. They also provide a great deal of information about the connection, including the number of *Echo Reply* messages received, the time elapsed for the pair of messages to be exchanged and a lot more. [See the topic describing ping for a full explanation of the utility.](#)



Key Concept: ICMPv4 *Echo (Request)* and *Echo Reply* messages are used to facilitate network reachability testing. A device can test its ability to perform basic communication with another one by sending an *Echo* message and waiting for an *Echo Reply* to be returned by the other device. The *ping* utility, a widely-used diagnostic tool in TCP/IP internetworks, makes use of these messages.

ICMPv4 Timestamp (Request) and Timestamp Reply Messages

All of the hosts and routers on an internetwork operate independently of each other. One aspect of this autonomy is that each device maintains a separate system clock. Since even highly-accurate clocks have slight differences in how accurately they keep time, as well as the time they are initialized with, this means that under normal circumstances, no two devices on an internetwork are guaranteed to have exactly the same time.

The creators of TCP/IP recognized that certain applications might not work properly if there was too much differential between the system clocks of a pair of devices. To support this requirement, they created a pair of ICMP messages that allow devices to exchange system time information. The initiating device creates a *Timestamp* message and sends it to the device with which it wishes to synchronize. That device responds with a *Timestamp Reply* message. Timestamp fields in these messages are used to mark the times that these messages are sent and received to allow the devices' clocks to be synchronized.



Note: As with [the Echo message](#), the *Timestamp* message is sometimes seen as *Timestamp Request*, though the word “Request” doesn't appear in its formal name.

ICMPv4 Timestamp and Timestamp Reply Message Format

The ICMPv4 *Timestamp* and *Timestamp Reply* messages have the same format. The originating device fills in some of the fields, and the replying device others. The format is as shown in [Table 98](#) and [Figure 147](#).

Table 98: ICMPv4 *Timestamp* and *Timestamp Reply* Message Format

Field Name	Size (bytes)	Description
Type	1	Type: Identifies the ICMP message type. For <i>Timestamp</i> messages the value is 13; for <i>Timestamp Reply</i> messages the value is 14.
Code	1	Code: Not used for <i>Timestamp</i> and <i>Timestamp Reply</i> messages; set to 0.
Checksum	2	Checksum: 16-bit checksum field for the ICMP header, as described in the topic on the ICMP common message format .
Identifier	2	Identifier: An identification field that can be used to help in matching <i>Timestamp</i> and <i>Timestamp Reply</i> messages.
Sequence Number	2	Sequence Number: A sequence number to help in matching <i>Timestamp</i> and <i>Timestamp Reply</i> messages.
Originate Timestamp	4	Originate Timestamp: A time value filled in by the originating device just before sending the <i>Timestamp</i> message.
Receive Timestamp	4	Receive Timestamp: A time value filled in by the responding device just as it receives the <i>Timestamp</i> message.
Transmit Timestamp	4	Transmit Timestamp: A time value filled in by the responding device just before sending back the <i>Timestamp Reply</i> message.

The *Identifier* and *Sequence Number* fields are used to match *Timestamp* and *Timestamp Reply* messages, exactly as they were used for *Echo* and *Echo Reply* messages. The *Identifier* field is intended as a higher-level label, like a session identifier, while the *Sequence Number* is often used to identify individual messages within a series. However, the use of these fields is up to the particular implementation.

All three timestamps are represented as the number of milliseconds since midnight, *Universal Time (UT)*, also called *Greenwich Mean Time* or *GMT*. The reason there are three timestamps instead of the two you might ordinarily expect, is that a separate timestamp is recorded by the responding device both when it receives the *Timestamp* message and when it generates the *Timestamp Reply*. When the *Reply* is received back by the originating device, it then has the times that both the *Timestamp* and the *Timestamp Reply* were sent.

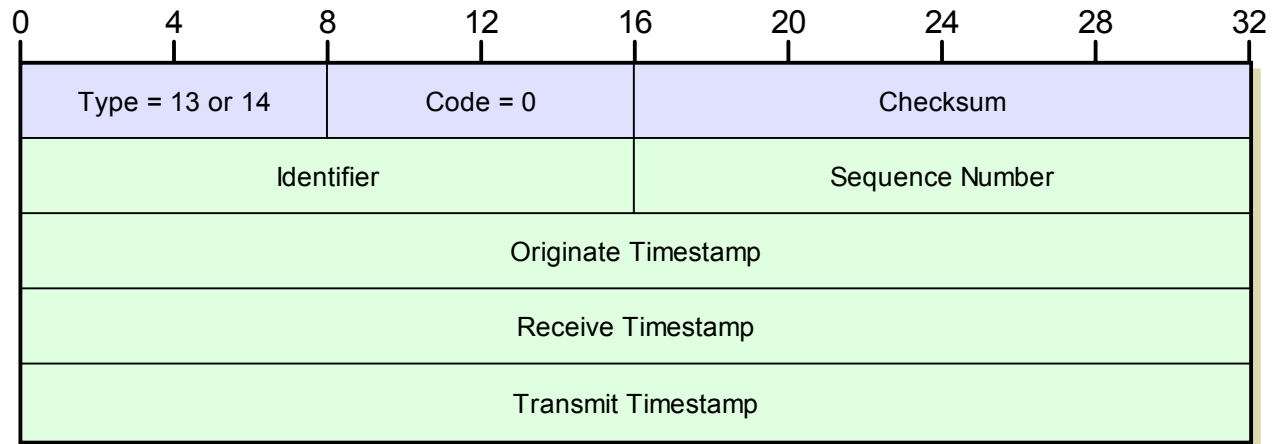

Figure 147: ICMPv4 *Timestamp* and *Timestamp Reply* Message Format

This allows the originating device to differentiate between the time required for transmitting datagrams over the network, and the time for the other device to process the *Timestamp* and turn it into a *Timestamp Reply*.

Issues Using Timestamp and Timestamp Reply Messages

In practice, even with three timestamp fields, it is difficult to coordinate system clocks over an internetwork—especially a large one like the Internet. The main problem is that the amount of time it takes to send a datagram between any pair of devices varies from one datagram to the next. And again, since IP is unreliable, it's possible the time for a datagram to be received could be infinite—it might be lost or dropped by a router.

This means that a simple exchange of *Timestamp* and *Timestamp Reply* messages is simply not a reliable enough method for ensuring that two devices are synchronized on a typical IP internetwork. For this reason, modern devices often use a more sophisticated method for time synchronization, such as the Network Time Protocol (NTP).

Note that unlike many of the other ICMP message types, support for *Timestamp* and *Timestamp Reply* messages is optional, for both hosts and routers.

ICMPv4 Router Advertisement and Router Solicitation Messages

In [the overview topic describing IP routing fundamentals](#), I discussed a critical aspect of IP internetwork design: the difference between the roles of a router and that of a host with regard to routing. Routers are charged with the job of routing datagrams, and therefore, of knowing routes and exchanging route information. Hosts generally do not know a great deal about routes; they rely on routers to convey datagrams intended for destinations outside the local network.

This dependence means that before a host can really participate on an internetwork, it needs to know the identity of at least one router on the local network. One way to ensure that this is the case is to just manually configure each host with the address of a local router as its default router. This method is simple, but has the typical drawbacks associated with manual processes—it is time-consuming to set up, difficult to maintain, and inflexible.

The Router Discovery Process

It would be better if there were some method whereby a host could automatically discover the identity of local routers, and learn important information about them. In IP, this process is called *router discovery*, and was first defined in RFC 1256, *ICMP Router Discovery Messages*. The messages referenced in the RFC title are the *ICMP Router Advertisement* message and the *Router Solicitation* message, and were added to the ICMP message types defined in earlier standards such as RFC 792.

Routers are responsible for sending *Router Advertisement* messages. These messages tell listening devices that the router exists, and provide important information about the router such as its address (or addresses, if it has more than one) and how long the host should retain information about the router. Routine *Router Advertisement* messages are sent on a regular basis, with the time between messages administrator-configurable (usually between 7 and 10 minutes). Hosts listen for these messages; when an advertisement is received, the host processes it and adds the information about the router to its routing table.

A host that has no manually-configured routing information will have no knowledge of routers when it first powers on. Having it sit for many minutes looking for a routine *Router Advertisement* message is inefficient. Instead of waiting, the host may send a *Router Solicitation* message on its local network(s). This will prompt any router that hears it to immediately send out an extra *Router Advertisement* message directly to that host.

ICMPv4 Router Advertisement Message Format

The ICMPv4 *Router Advertisement* message format is shown in [Table 99](#) and [Figure 148](#).

Table 99: ICMPv4 Router Advertisement Message Format (Page 1 of 2)

Field Name	Size (bytes)	Description
Type	1	Type: Identifies the ICMP message type. For <i>Router Advertisement</i> messages the value is 9.
Code	1	Code: Normally set to 0. When a Mobile IP agent is sending a <i>Router Advertisement</i> with an <i>Agent Advertisement</i> extension, it may set the value to 16 if the device is a mobile agent only and doesn't intend to handle normal traffic. See the discussion of Mobile IP agent discovery for details.
Checksum	2	Checksum: 16-bit checksum field for the ICMP header, as described in the topic on the ICMP common message format .
Num Addr	1	Number Of Addresses: The number of addresses associated with this router that are included in this advertisement.

Table 99: ICMPv4 Router Advertisement Message Format (Page 2 of 2)

Field Name	Size (bytes)	Description									
Addr Entry Size	1	Address Entry Size: The number of 32-bit words of information included with each address. Since in this message format each router address has a 32-bit address and a 32-bit preference level, this value is fixed at 2.									
Lifetime	2	Lifetime: The number of seconds that a host should consider the information in this message valid.									
Router Address Entries	Value of <i>Num Addrs</i> field * 8	<p>Router Address Entries: A number of router address entries equal to the value of the <i>Num Addrs</i> field. Each is 8 bytes and has two subfields:</p> <table border="1"> <thead> <tr> <th>Subfield Name</th> <th>Size (bytes)</th> <th>Description</th> </tr> </thead> <tbody> <tr> <td>Router Address</td> <td>4</td> <td>Router Address: A valid address for an interface to the router sending this message.</td> </tr> <tr> <td>Preference Level</td> <td>4</td> <td>Preference Level: The preference level of this address. When more than one address is included in an advertisement, this field indicates which address the router would prefer that hosts use. Higher values mean greater preference.</td> </tr> </tbody> </table>	Subfield Name	Size (bytes)	Description	Router Address	4	Router Address: A valid address for an interface to the router sending this message.	Preference Level	4	Preference Level: The preference level of this address. When more than one address is included in an advertisement, this field indicates which address the router would prefer that hosts use. Higher values mean greater preference.
		Subfield Name	Size (bytes)	Description							
Router Address	4	Router Address: A valid address for an interface to the router sending this message.									
Preference Level	4	Preference Level: The preference level of this address. When more than one address is included in an advertisement, this field indicates which address the router would prefer that hosts use. Higher values mean greater preference.									

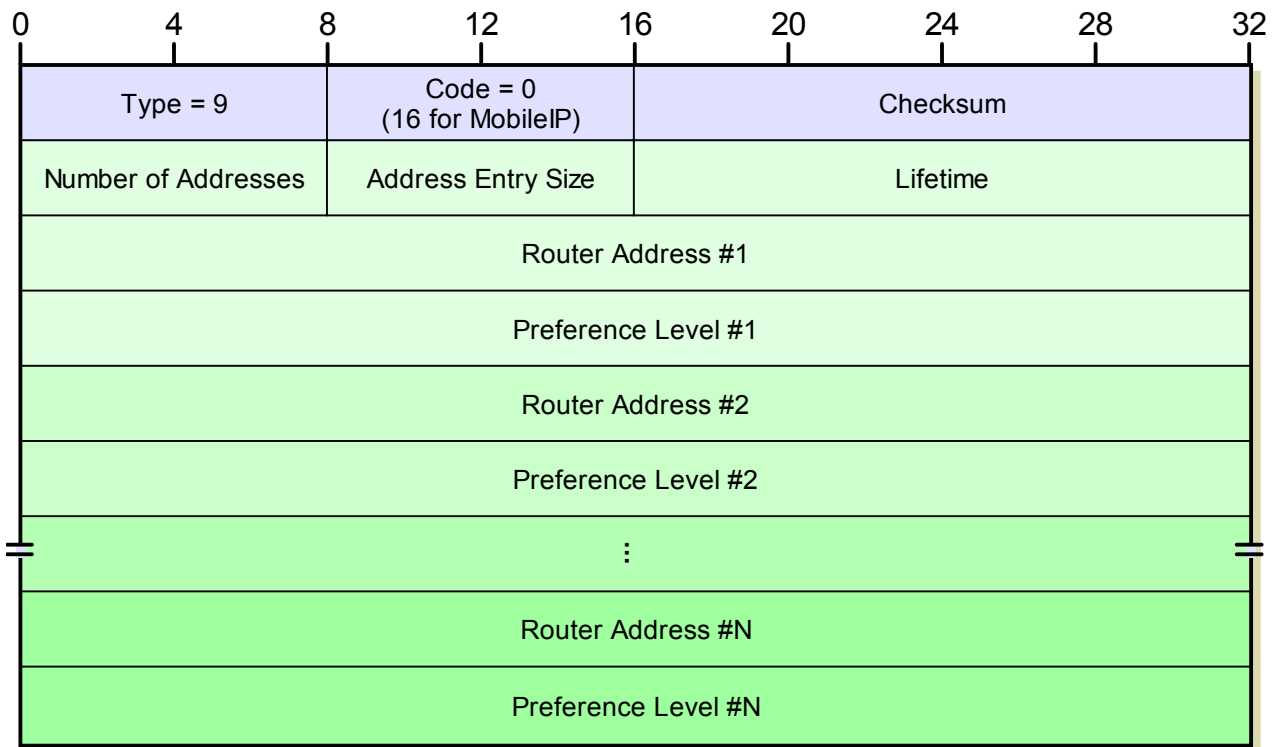

Figure 148: ICMPv4 Router Advertisement Message Format

ICMPv4 Router Solicitation Message Format

ICMPv4 *Router Solicitation* messages are much simpler, because they only need to convey a single piece of information: “if you are a router and can hear this, please send a *Router Advertisement* to me”. The format is therefore just the trivial set of fields shown in [Table 100](#) and [Figure 149](#).

Table 100: ICMPv4 Router Solicitation Message Format

Field Name	Size (bytes)	Description
Type	1	Type: Identifies the ICMP message type. For Router Solicitation messages the value is 10.
Code	1	Code: Not used; value set to 0.
Checksum	2	Checksum: 16-bit checksum field for the ICMP header, as described in the topic on the ICMP common message format .
Reserved	4	Reserved: 4 reserved bytes sent as 0.

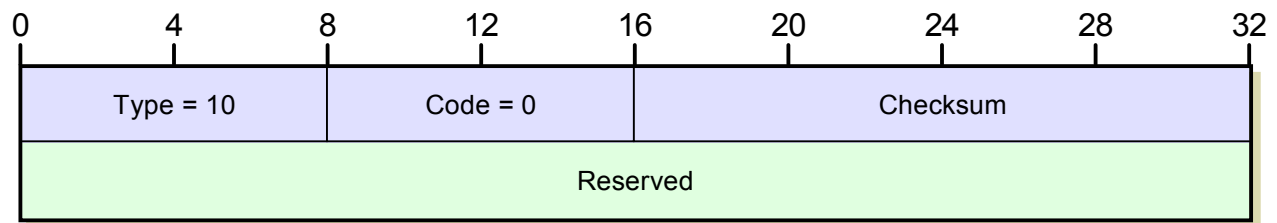

Figure 149: ICMPv4 Router Solicitation Message Format

Addressing and Use of Router Advertisement and Router Solicitation Messages

If possible, both *Router Advertisement* and *Router Solicitation* messages are sent out multicast for efficiency. *Router Advertisements* use the “all devices” multicast address (224.0.0.1), since they are intended for hosts to hear, while *Router Solicitation* messages use the “all routers” multicast address (224.0.0.2). If the local network does not support multicast, messages are instead sent out broadcast (to address 255.255.255.255).

It is important to remember that just like [ICMP Redirect messages](#), *Router Advertisement* messages are not a generalized method for exchanging routing information. They are a support mechanism only, used to inform hosts about the existence of routers. Detailed information about routes is communicated between routers using [routing protocols](#), like [RIP](#) and [OSPF](#).

I should also mention that while I suggested router discovery was the alternative to manual configuration of a host's default router, there are other alternatives as well. For example, a host configuration protocol like [DHCP](#) can allow a host to learn the address of a default router on the local network.

Finally, note that when [Mobile IP](#) is implemented, *Router Advertisement* messages are used as the basis for Mobile-IP-aware routers to send *Agent Advertisements*. One or more special *extensions* are added to the regular *Router Advertisement* format to create an *Agent Advertisement*. This is discussed extensively in [the topic on Mobile IP agent discovery](#).



Key Concept: ICMP *Router Advertisement* messages are sent regularly by IP routers to inform hosts of their presence and characteristics, so hosts know to use them for delivery of datagrams to distant hosts. A host that is new to a network and wants to find out immediately what routers are present may send a *Router Solicitation*, which will prompt listening routers to send out *Router Advertisements*.

ICMPv4 Address Mask Request and Reply Messages

When the Internet Protocol was first developed, IP addresses were based on a simple two-level structure, with a *network identifier* and *host identifier*. To provide more flexibility, a technique called *subnetting* was soon developed that expands the addressing scheme into a three-level structure, with each address containing a network identifier, subnet identifier and host identifier. The *subnet mask* is a 32-bit number that tells devices (and users) which bits are part of the subnet identifier, as opposed to the host identifier. All of this is described in considerable detail in [the section on IP addressing](#).

To function properly in a subnetting environment, each host must know the [subnet mask](#) that corresponds to each address it is assigned—without the mask it cannot properly interpret IP addresses. Just like [determining the identity of a local router](#), a host can be informed of the local network's subnet mask either manually or automatically. The manual method is simply to have the subnet mask manually assigned to each host. The automatic method makes use of a pair of ICMP messages for subnet mask determination, which were defined in RFC 950, the same standard that defined [subnetting](#) itself.

To use this method, a host sends an *Address Mask Request* message on the local network, usually to get a response from a router. If it knows the address of a local router it may send the request directly (unicast), but otherwise will broadcast it to any listening router. A local router (or other device) will hopefully receive this message and respond back with an *Address Mask Reply* containing the subnet mask for the local network. This process is somewhat similar to the mechanism used by a host to solicit a router to respond with a *Router Advertisement*, except that routers do not routinely send subnet mask information; it must be requested.

ICMPv4 Address Mask Request and Address Mask Reply Message Format

The *Address Mask Request* and *Address Mask Reply*, like some other request/reply pairs, have the same basic format—the host creates the request with all fields filled in except the subnet mask value itself, and the router supplies the mask and sends the reply back to the host. The format is described in [Table 101](#) and [Figure 150](#).

Table 101: ICMPv4 Address Mask Request and Address Mask Reply Message Format

Field Name	Size (bytes)	Description
Type	1	Type: Identifies the ICMP message type. For <i>Address Mask Request</i> messages the value is 17; for <i>Address Mask Reply</i> messages, it is 18.
Code	1	Code: Not used for either message type; set to 0.
Checksum	2	Checksum: 16-bit checksum field for the ICMP header, as described in the topic on the ICMP common message format .
Identifier	2	Identifier: An identification field that can be used to help in matching <i>Address Mask Request</i> and <i>Address Mask Reply</i> messages.
Sequence Number	2	Sequence Number: A sequence number to help in matching <i>Address Mask Request</i> and <i>Address Mask Reply</i> messages.
Address Mask	4	Address Mask: The subnet mask for the local network, filled in by the router in the <i>Address Mask Reply</i> message.

The *Identifier* and *Sequence Number* fields can be used to match up requests and replies, as they are for *Echo* and *Echo Reply* messages. However, a host won't normally send multiple requests for subnet masks the way it might send *Echo* messages for testing. For this reason, the *Identifier* and *Sequence Number* fields may be ignored by some implementations.

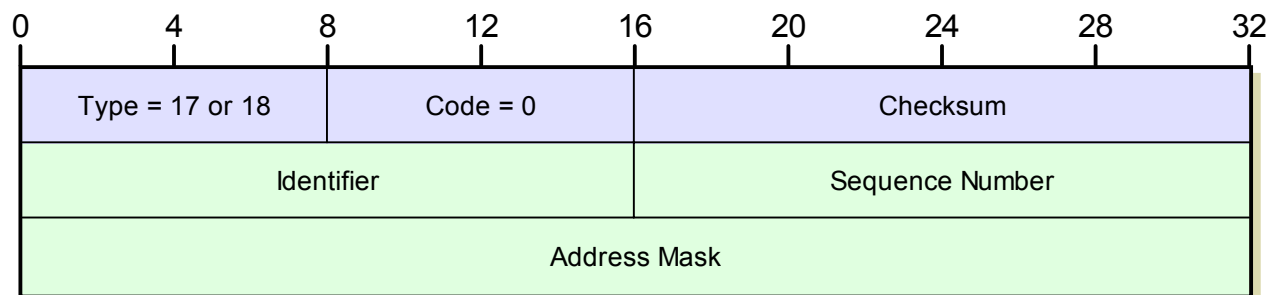

Figure 150: ICMPv4 Address Mask Request and Address Mask Reply Message Format

Use of Address Mask Request and Address Mask Reply Messages

The use of *Address Mask Request* and *Address Mask Reply* messages is optional, just as the router discovery described in the previous topic is. Other methods besides these messages or manual configuration may be used to tell a host what subnet mask to use. Again, a common alternative to ICMP for this is a host configuration protocol like the TCP/IP [Dynamic Host Configuration Protocol \(DHCP\)](#). Routers do have to be able to respond to *Address Mask Requests* for hosts that choose to send them.

ICMPv4 Traceroute Messages

The *Echo* and *Echo Reply* messages we explored [earlier in this section](#) are used for the most basic type of test that can be conducted between two devices: checking if they can communicate. A more sophisticated test can also be performed, to see not just if the devices are able to talk, but discover the exact sequence of routers used to move datagrams between them. In TCP/IP this diagnostic is performed using the [traceroute \(or tracert\) utility](#).

The first implementation of *traceroute* used a clever application of [Time Exceeded error messages](#). By sending a test message to a destination first with a *Time To Live* value of 1, then 2, then 3 and so on, each router in the path between the source and destination would successively discard the test messages and send back a *Time Exceeded* message, displaying the sequence of routers between the two hosts. This bit of “trickery” works well enough in general terms, but is suboptimal in a couple of respects. For example, it requires the source device to send one test message for each router in the path, instead of just a single test message. It also doesn't take into account the possibility that the path between two devices may change during the test.

Recognizing these limitations, a new experimental standard was developed in 1993 that defined a more efficient way to conduct a *traceroute*: RFC 1393, [Traceroute Using an IP Option](#). As the title suggests, this method of doing a *traceroute* works by having the source device send a single datagram to the destination, containing a special *Traceroute* IP option. Each router that sees that option as the test message is conducted along the route, responds back to the original source with an ICMP *Traceroute* message, also defined in RFC 1393.

ICMPv4 Traceroute Message Format

Since the *Traceroute* message was specifically designed for the *traceroute* utility, it was possible to incorporate into it extra information of use to a host tracing a route. The message format is as shown in [Table 102](#) and [Figure 151](#).

Table 102: ICMPv4 Traceroute Message Format

Field Name	Size (bytes)	Description
Type	1	Type: Identifies the ICMP message type, in this case 30.
Code	1	Code: Set to the value 0 if the datagram the source device sent was successfully sent to the next router, or 1 to indicate that the datagram was dropped (meaning the traceroute failed).
Checksum	2	Checksum: 16-bit checksum field for the ICMP header, as described in the topic on the ICMP common message format .
ID Number	2	ID Number: An identification field used to match up this <i>Traceroute</i> message to the original message sent by the source (the one containing the <i>Traceroute</i> IP option).
Unused	2	Unused: Not used, set to 0.
Outbound Hop Count	2	Outbound Hop Count: The number of routers the original message has already passed through.
Return Hop Count	2	Return Hop Count: The number of routers the return message has passed through.
Output Link Speed	4	Output Link Speed: The speed of the link over which the <i>Traceroute</i> message is being sent, in bytes per second.
Output Link MTU	4	Output Link MTU: The Maximum Transmission Unit (MTU) of the link over which the <i>Traceroute</i> message is being sent, in bytes.

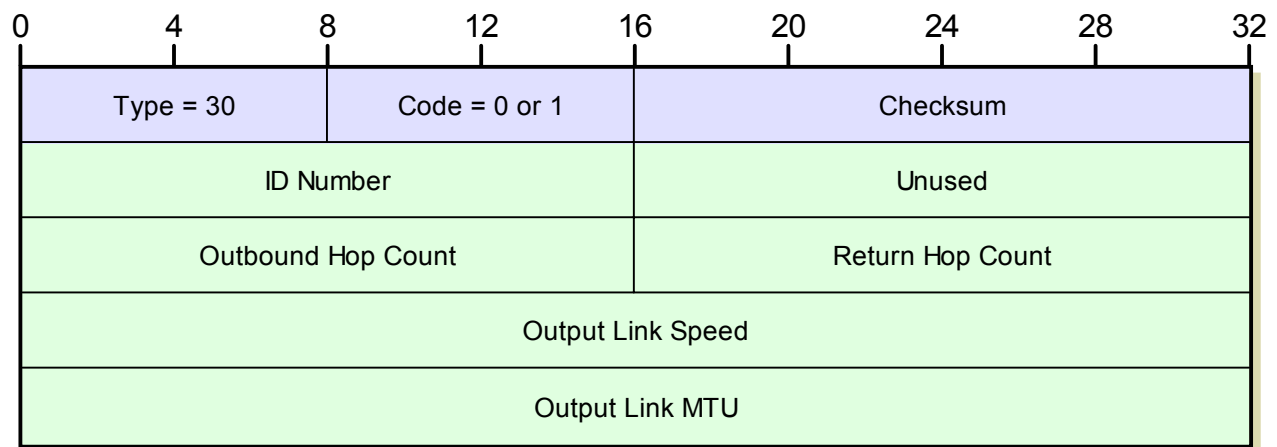

Figure 151: ICMPv4 Traceroute Message Format

Why Traceroute Messages Are Not Widely Used

Note that while this method of implementing *traceroute* indeed has advantages over the older *Time Exceeded* method, it has one critical flaw as well: it requires changes to both hosts and routers to support the new IP option and the *Traceroute* ICMP message. People aren't big on change, especially when it comes to the basic operation of IP. For this reason, RFC 1393 never moved beyond “experimental” status, and most IP devices still use the older method of implementing *traceroute*. It is possible that you may encounter ICMP *Traceroute* messages, however, so it's good to know they exist.



Key Concept: ICMP *Traceroute* messages were designed to provide a more capable way of implementing the traceroute (tracert) utility. However, most TCP/IP implementations still use ICMP *Time Exceeded* messages for this task.



ICMP Version 6 (ICMPv6) Error Message Types and Formats

The original ICMP defines for version 4 of the Internet Protocol (IPv4) a number of error messages to allow communication of problems on an internetwork. When IP version 6 (IPv6) was developed, the differences between IPv4 and IPv6 were significant enough that a new version of ICMP was also required: the *Internet Control Message Protocol (ICMPv6) for the Internet Protocol Version 6 (IPv6)*, currently specified in RFC 2463. Like ICMPv4, ICMPv6 defines several error messages that let a source be informed when something goes wrong.

In this section I describe the four ICMPv6 error messages defined in RFC 2463. I first discuss ICMPv6 *Destination Unreachable* messages, used to tell a device a datagram it sent could not be delivered for a variety of reasons. I describe *Packet Too Big* error messages, which are sent when a datagram can't be sent due to being too large for an underlying network it needs to traverse. I explain the use of *Time Exceeded* messages, which indicate that too much time was taken to accomplish a transmission. I conclude with a look at messages, which provide a generalized way of reporting errors not described by any of the preceding ICMPv6 error message types.



Note: Three of the four ICMPv6 error messages (all except *Packet Too Big*) are equivalent to the [ICMPv4 error messages](#) that have the same names. However, to allow this section to stand on its own, I describe each one fully, in addition to pointing out any significant differences between the ICMPv4 and ICMPv6 version of the message.

ICMPv6 Destination Unreachable Messages

Version 6 of the Internet Protocol (IPv6) includes some important enhancements over the older version 4, but the basic operation of the two protocols is still fundamentally the same. Like IPv4, IPv6 is an unreliable network protocol that makes a “best effort” to deliver datagrams, but offers no guarantees that they will always get there. Just as was the case in IPv4, devices on an IPv6 network must not assume that datagrams sent to a destination will always be received.

When a datagram cannot be delivered, recovery from this condition normally falls to higher-layer protocols like TCP, which will detect the miscommunication and re-send the lost datagrams. In some situations, such as a datagram dropped due to congestion of a router, this is sufficient, but in other cases a datagram may not be delivered due to an inherent problem with how it is being sent. For example, the source may have specified an invalid destination address, which means even if resent many times, the datagram will never get to its intended recipient.

In general, having the source just re-send undelivered datagrams while having no idea why they were lost is inefficient. It is better to have a feedback mechanism that can tell a source device about undeliverable datagrams and provide some information about why the

datagram delivery failed. As in ICMPv4, in ICMPv6 this is done with *Destination Unreachable* messages. Each message includes a code that indicates the basic nature of the problem that caused the datagram not to be delivered, and includes all or part of the datagram that was undelivered, to help the source device diagnose the problem.

ICMPv6 Destination Unreachable Message Format

Table 103 and Figure 152 illustrate the specific format for ICMPv6 *Destination Unreachable* messages:

Table 103: ICMPv6 Destination Unreachable Message Format

Field Name	Size (bytes)	Description
Type	1	Type: Identifies the ICMPv6 message type; for <i>Destination Unreachable</i> messages this is set to 1.
Code	1	Code: Identifies the “subtype” of unreachable error being communicated. See Table 104 for a full list of codes and what they mean.
Checksum	2	Checksum: 16-bit checksum field for the ICMP header, as described in the topic on the ICMP common message format.
Unused	4	Unused: 4 bytes that are left blank and not used.
Original Datagram Portion	Variable	Original Datagram Portion: As much of the IPv6 datagram as will fit without causing the size of the ICMPv6 error message (including its own IP header) to exceed the minimum IPv6 maximum transmission unit (MTU) of 1280 bytes.

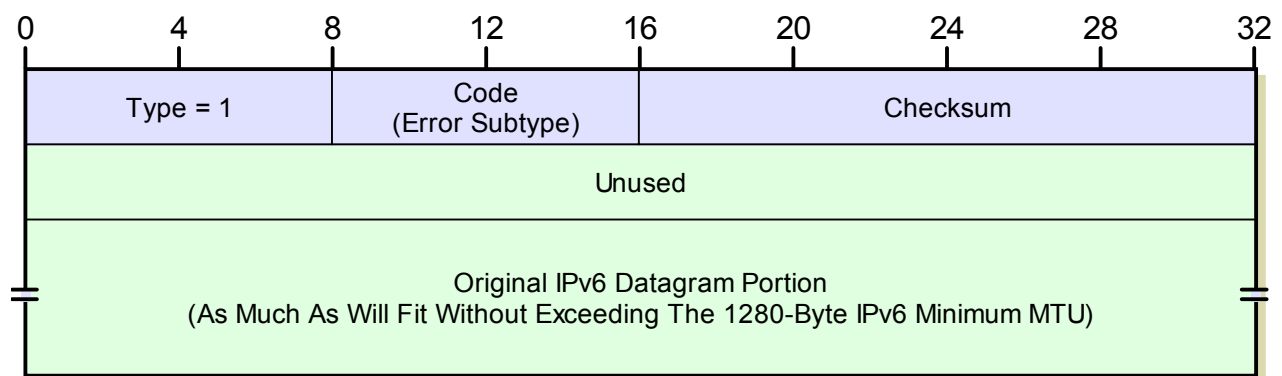

Figure 152: ICMPv6 Destination Unreachable Message Format

ICMPv6 Destination Unreachable Message Subtypes

There are a number of different reasons why a destination may be unreachable. To provide additional information about the nature of the problem to the device that originally tried to send the datagram, a value is placed in the message's *Code* field. One interesting difference between ICMPv4 and ICMPv6 *Destination Unreachable* messages is that there

are many fewer *Code* values for ICMPv6. The ICMPv6 *Code* values were “streamlined”, mainly because several of the ICMPv4 codes were related to relatively obscure features that aren't applicable to ICMPv6.

Table 104 shows the different *Code* values, corresponding message subtypes and a brief explanation of each:

Table 104: ICMPv6 *Destination Unreachable* Message Subtypes

Code Value	Message Subtype	Description
0	<i>No Route To Destination</i>	The datagram was not delivered because it could not be routed to the destination. Since this means the datagram could not be sent to the destination device's local network, this is basically equivalent to the “Network Unreachable” message subtype in ICMPv4.
1	<i>Communication With Destination Administratively Prohibited</i>	The datagram could not be forwarded due to filtering that blocks the message based on its contents. Equivalent to the message subtype with the same name (and <i>Code</i> value 13) in ICMPv4.
3	<i>Address Unreachable</i>	There was a problem attempting to deliver the datagram to the host specified in the destination address. This code is equivalent to the ICMPv4 “Host Unreachable” code and usually means the destination address was bad or there was a problem with resolving it into a layer two address.
4	<i>Port Unreachable</i>	The destination port specified in the UDP or TCP header was invalid or does not exist on the destination host.

Note that *Code* value 2 is not used. Also, *Destination Unreachable* messages are only sent when there is a fundamental problem with delivering a particular datagram; they are not sent when a datagram is dropped simply due to congestion of a router.

Processing of Destination Unreachable Messages

It is up to the recipient of an ICMPv6 *Destination Unreachable* message to decide what to do with it. However, just as the original datagram may not reach its destination, the same is true of the *Destination Unreachable* message itself. Therefore, a device cannot rely on the receipt of one of these error messages to inform it of every delivery problem. This is especially true given that it is possible some unreachable destination problems may not be detectable.



Key Concept: ICMPv6 *Destination Unreachable* messages are used in the same manner as the ICMPv4 message of that name: to inform a sending device of a failure to deliver an IP datagram. The message's *Code* field provides information about the nature of the delivery problem (though the *Code* values are different than they are in ICMPv4.)

ICMPv6 Packet Too Big Messages

One of the most interesting changes made to the operation of the Internet Protocol in version 6 is related to the process of datagram fragmentation and reassembly. In IPv4, a host can send a datagram of any size allowed by the IP specification out onto the inter-network. If a router needs to send the datagram over a physical link that has a maximum transmission unit (MTU) size that is too small for the size of the datagram, it will automatically *fragment* the datagram and send the fragments individually so they will fit. The destination device will receive the fragments and reassemble them. I explain the basics behind this in [the section on IPv4 datagram size, MTU, fragmentation and reassembly](#).



Note: Recall that “packet” is a synonym for “datagram”. I generally use the latter term, but this message has “packet” in the name and it’s not like I was just going to change it!

Even though it is convenient for hosts to be able to rely on routers to automatically fragment messages as needed, it is inefficient for routers to spend time doing this. For this reason, in IPv6 the decision was made to not allow routers to fragment datagrams. This puts the responsibility on each host to ensure that datagrams they send out are small enough to fit over every physical network between itself and any destination. This is done either by using the IPv6 default minimum MTU of 1280, which every physical link must support, or a special *Path MTU Discovery* process for determining the minimum MTU between a pair of devices. Again, the full details are in [the discussion of IPv6 datagram size, MTU, fragmentation and reassembly](#).

If an IPv6 router is not allowed to fragment an IPv6 datagram that is too large to fit on the next physical link over which it must be forwarded, what should the router do with it? The datagram can't be forwarded, so the router has no choice but to discard it. When this happens, the router is required to report this occurrence back to the device that initially sent the datagram, using an ICMPv6 *Packet Too Big* message. The source device will know that it needs to fragment the datagram in order to have it successfully reach its destination.

ICMPv6 Packet Too Big Message Format

[Table 105](#) and [Figure 153](#) show the format for ICMPv6 *Packet Too Big* messages:

Table 105: ICMPv6 Packet Too Big Message Format (Page 1 of 2)

Field Name	Size (bytes)	Description
<i>Type</i>	1	Type: Identifies the ICMPv6 message type; for <i>Packet Too Big</i> messages this is set to 2.
<i>Code</i>	1	Code: Not used for this message type; set to 0.
<i>Checksum</i>	2	Checksum: 16-bit checksum field for the ICMP header, as described in the topic on the ICMP common message format .

Table 105: ICMPv6 *Packet Too Big* Message Format (Page 2 of 2)

Field Name	Size (bytes)	Description
MTU	4	MTU: The maximum transmission unit (MTU) size, in bytes, of the physical link over which the router wanted to send the datagram, but was not able to do so due to the datagram's size. Including this value in the <i>Packet Too Big</i> message tells the source device the size it needs to use for its next transmission to this destination to avoid this problem in the future (at least for this particular link.)
Original Datagram Portion	Variable	Original Datagram Portion: As much of the IPv6 datagram as will fit without causing the size of the ICMPv6 message (including its own IP header) to exceed the minimum IPv6 MTU of 1280 bytes.

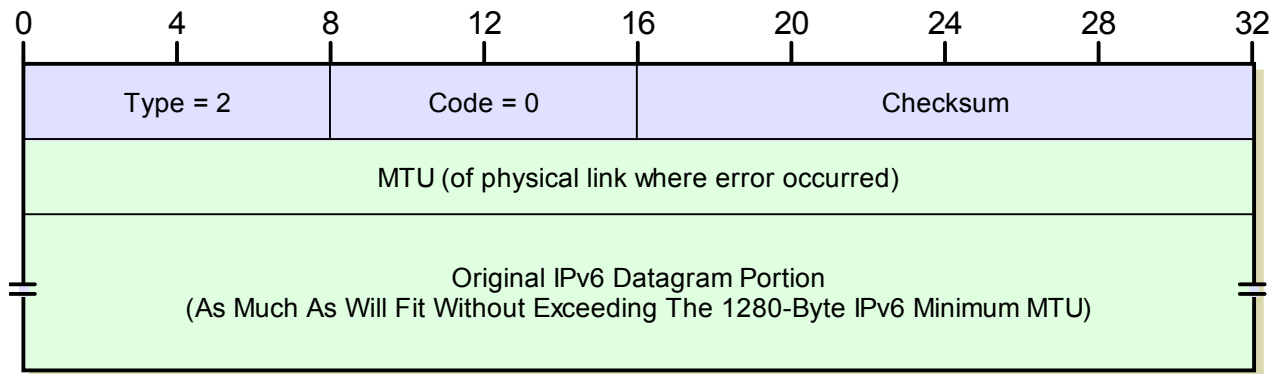

Figure 153: ICMPv6 *Packet Too Big* Message Format



Key Concept: In IPv6, routers are not allowed to fragment datagrams that are too large to send over a physical link to which they are connected. An oversized datagram is dropped, and an ICMPv6 *Packet Too Big* message sent back to the datagram's originator to inform it of this occurrence.

Applications of *Packet Too Big* Messages

While *Packet Too Big* is obviously an error message, it also has another use: the implementation of *Path MTU Discovery*. This process, described in RFC 1981, defines a method for a device to determine the minimum MTU for a path to a destination. To perform path MTU discovery, the source device sends a series of test messages, decreasing the size of the datagram until it no longer receives *Packet Too Big* messages back in response to its tests. [See the topic on IPv6 MTU and fragmentation issues for a bit more detail on this.](#)



Note: The *Packet Too Big* message is new to ICMPv6. However, its use is somewhat similar to the use of the *Fragmentation Needed and DF Set* version of the [ICMP4 Destination Unreachable](#) message type, which is used as part of IPv4's path MTU discovery feature.

Incidentally, *Packet Too Big* is an exception to [the rule that ICMP messages are sent only in response to unicast datagrams](#); it may be sent in reply to an oversized multicast datagram. If this occurs, it is important to realize that some of the intended targets of the multicast may still have received it, if the path the multicast took to them did not go through the link with the small MTU that caused the error.

ICMPv6 Time Exceeded Messages

The engineers who first designed the Internet Protocol recognized that due to the nature of how routing works on an internetwork, there was always a danger that a datagram might get “lost in the system” and spend too much time being passed from one router to another. They included in IPv4 datagrams a field called *Time To Live*, which was intended to be set to a time value by the device sending the datagram, and used as a timer to cause the discard of the datagram if it took too long to get it to its destination.

Eventually, the meaning of this field changed so it was used not as a time in seconds but a number of hops through which the datagram was allowed to be sent. In IPv6, the new meaning of this field was formalized when it was renamed *Hop Limit*. Regardless of name, the field still has the same basic purpose: it restricts how long a datagram can exist on an internetwork by limiting the number of times routers can forward it. This is particularly designed to provide protection against *router loops* that may occur in large or improperly-configured internetworks. An example of this situation is where Router *A* thinks datagrams intended for network *X* should next go to Router *B*; *B* thinks they should go to Router *C*; and *C* thinks they need to go to *A*. Without a *Hop Limit*, such datagrams would circle forever, clogging networks and never accomplishing anything useful, as shown in [Figure 154](#).

Each time a router passes an IPv6 datagram, it decreases the *Hop Limit* field. If the value ever reaches zero, the datagram *expires* and is discarded. When this happens, the router that dropped the datagram sends an ICMPv6 *Time Exceeded* message back to the datagram's originator to inform it that the datagram was dropped. This is basically the same as the ICMPv4 Time Exceeded message. As in the ICMPv4 case, the device receiving the message must decide whether and how to respond to receipt of the message. For example, since the error can be caused by a device using a *Hop Limit* that was too low, the device may try to re-send the datagram with a higher value before concluding that there is a routing problem and giving up. ([See the topic covering the ICMPv4 Time Exceeded message for an illustration of how TTL expiration works.](#))

Just as with the ICMPv4 equivalent, there is also another “time expiration” situation that ICMPv6 *Time Exceeded* messages are used for. When an IP message is broken into fragments that are sent independently, the destination device is charged with reassembling

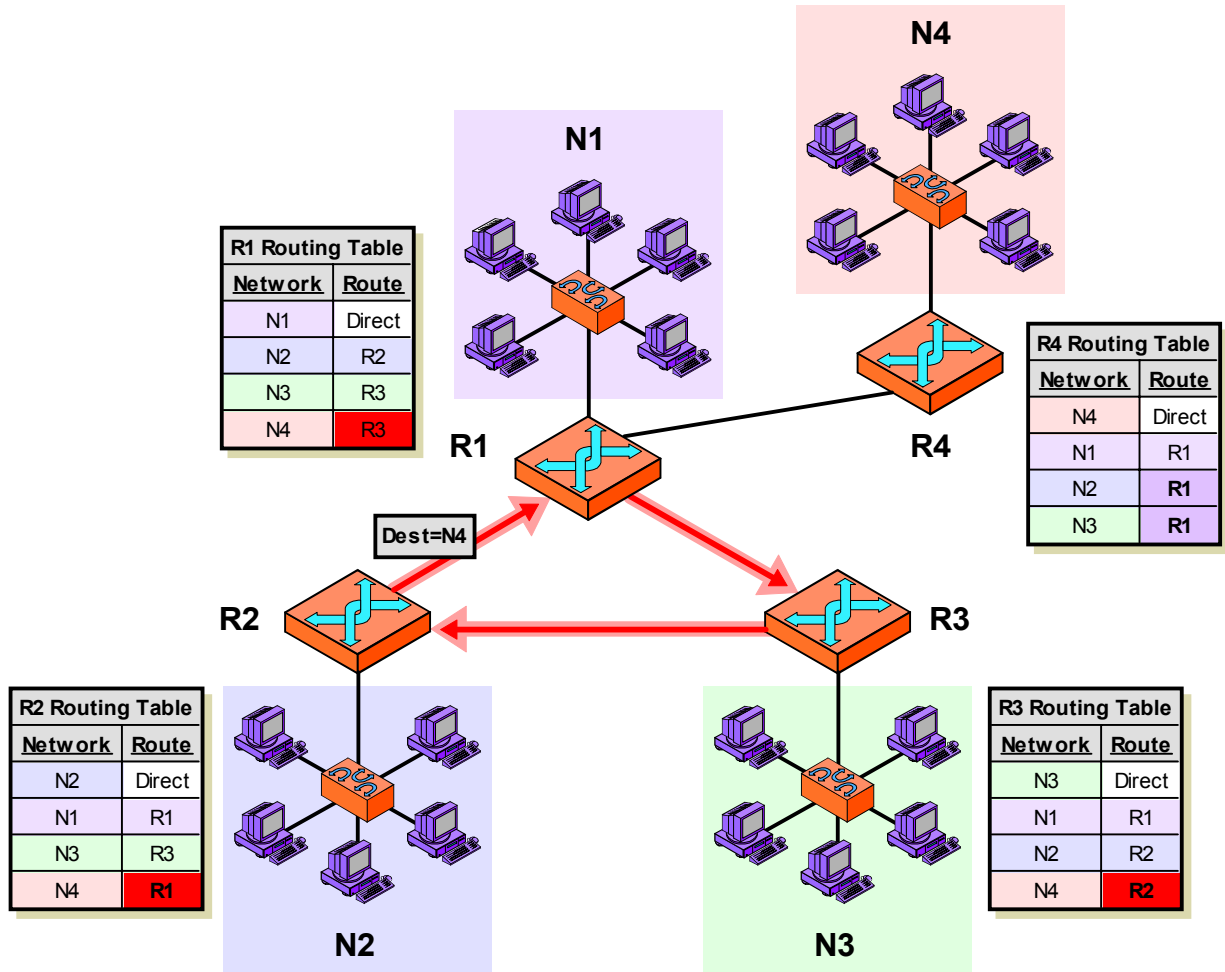

Figure 154: An Example of A Router Loop

This diagram shows a simple internetwork consisting of four networks, each of which is served by a router. It is an adaptation of Figure 93, but in this case the routing tables have been set up incorrectly. *R1* thinks that it needs to route any traffic intended for network *N4* to *R3*; *R3* thinks it goes to *R2*; and *R2* thinks it goes back to *R1*. This means that when any device tries to send to *N4*, the datagram will circle this “triangle” until its *Hop Limit* is reached, at which point an ICMPv6 *Time Exceeded* message will be generated.

the fragments into the original message. One or more fragments may not make it to the destination, however. To prevent the device from waiting forever, it sets a timer when the first fragment arrives. If this timer expires before all of the other fragments are also received, the device gives up on this message. The fragments are tossed out, and a *Time Exceeded* message is also generated.

ICMPv6 Time Exceeded Message Format

The format for ICMPv6 *Time Exceeded* messages can be found in [Table 106](#) and [Figure 155](#).

Table 106: ICMPv6 *Time Exceeded* Message Format

Field Name	Size (bytes)	Description
Type	1	Type: Identifies the ICMPv6 message type; for <i>Time Exceeded</i> messages this is set to 3.
Code	1	Code: Identifies the “subtype” of time error being communicated. A value of 0 indicates expiration of the <i>Hop Limit</i> field; a value of 1 indicates that the fragment reassembly time has been exceeded.
Checksum	2	Checksum: 16-bit checksum field for the ICMP header, as described in the topic on the ICMP common message format .
Unused	4	Unused: 4 bytes left blank and not used.
Original Datagram Portion	Variable	Original Datagram Portion: As much of the IPv6 datagram as will fit without causing the size of the ICMPv6 error message (including its own IP header) to exceed the minimum IPv6 maximum transmission unit (MTU) of 1280 bytes.

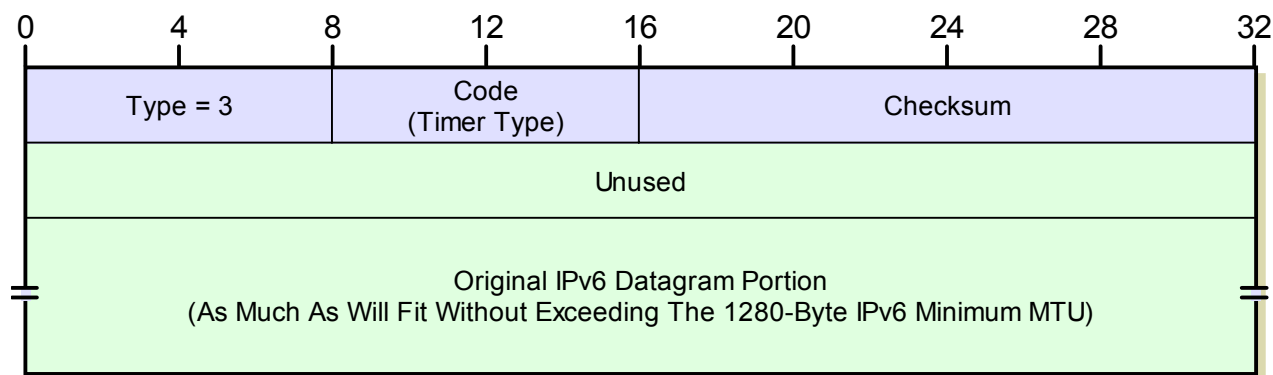

Figure 155: ICMPv6 *Time Exceeded* Message Format



Key Concept: Like their ICMPv4 namesakes, ICMPv6 *Time Exceeded* messages are sent in two different “time-related” circumstances. The first is if a datagram’s *Hop Limit* field is reduced to zero, causing it to expire and the datagram to be dropped. The second is when all the pieces of a fragmented message are not received before the recipient’s reassembly timer expires.

Applications of Time Exceeded Messages

In IPv4, ICMP *Time Exceeded* messages are used both as an error message and in a clever application to implement the TCP/IP *traceroute* command. This is done by first sending a “dummy” datagram is sent with a *Time To Live* value of 1, causing the first hop in the route to discard the datagram and send back an ICMP *Time Exceeded*. Then, a second datagram is sent to the same destination with a *TTL* value of 2, causing the second device in the route to report back a *Time Exceeded*, and so on.

There is of course an IPv6 version of *traceroute*, sometimes called *traceroute6*. Due to IPv6 and its protocols and applications still being in development, I have not been able to confirm definitively that *traceroute6* is implemented using ICMPv6 *Time Exceeded* messages in the manner described above, but I believe this is the case (and it certainly would make sense.) [See the topic discussing traceroute for further information.](#)

ICMPv6 Parameter Problem Messages

The ICMPv6 *Destination Unreachable*, *Packet Too Big* and *Time Exceeded* messages described in the previous topics in this section are used to indicate specific error conditions to the original sender of a datagram. Recognizing that a router or host may encounter some other problem in processing a datagram that is not covered by any of these message types, ICMPv6 includes a generic error message type, just as ICMPv4 did. This is called the ICMPv6 *Parameter Problem* message.

As the name suggests, a *Parameter Problem* message indicates that a device found a problem with a parameter (another name for a datagram field) while attempting to work its way through the header (or headers) in an IPv6 datagram. This message is only generated when the error encountered is serious enough that the device could not make sense of the datagram and had to discard it. That is, if an error is found that a device is able to recover from and not drop the datagram, no *Parameter Problem* message is created.

As was the case for [the ICMPv4 version of this message](#), the ICMPv6 message was designed to be generic, so it can indicate an error in basically any field in the original datagram. A special *Pointer* field is used that points to the place in that datagram where the error was encountered. By looking at the structure of the original message (which as you may recall is included, up to a certain size, in the ICMP message format) the original device can tell which field contained the problem. The *Code* value is also used to communicate additional general information about the nature of the problem.

ICMPv6 Parameter Problem Message Format

Table 107 and Figure 156 show the format for ICMPv4 *Parameter Problem* messages:

Table 107: ICMPv6 Parameter Problem Message Format

Field Name	Size (bytes)	Description
Type	1	Type: Identifies the ICMPv6 message type; for <i>Parameter Problem</i> messages this is set to 4.
Code	1	Code: Identifies the general class of the parameter problem. See Table 108 for more information.
Checksum	2	Checksum: 16-bit checksum field for the ICMP header, as described in the topic on the ICMP common message format .
Pointer	4	Pointer: An offset that points to the byte location in the original datagram that caused the <i>Parameter Problem</i> message to be generated. The device receiving the ICMP message can use this value to get an idea of which field in the original message had the problem.
Original Datagram Portion	Variable	Original Datagram Portion: As much of the IPv6 datagram as will fit without causing the size of the ICMPv6 error message (including its own IP header) to exceed the minimum IPv6 maximum transmission unit (MTU) of 1280 bytes.

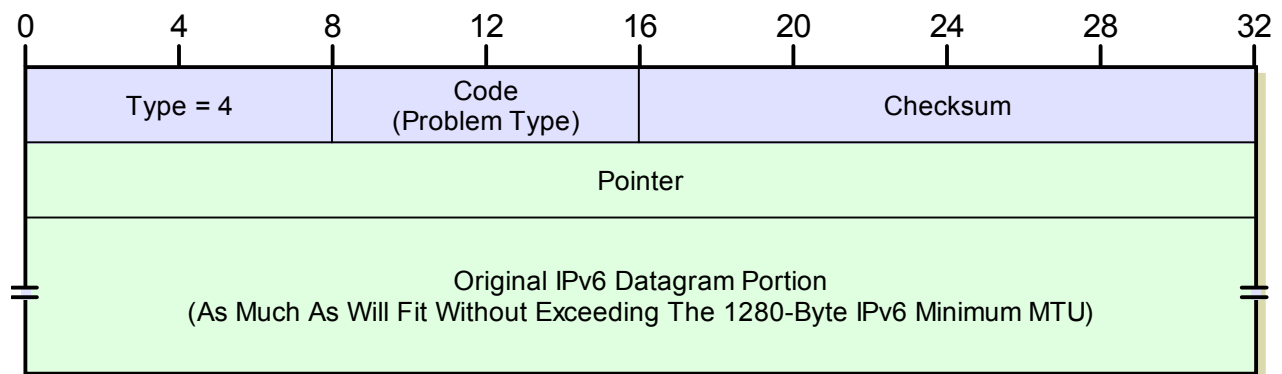

Figure 156: ICMPv6 Parameter Problem Message Format

Parameter Problem Message Interpretation Codes and The Pointer Field

The *Pointer* field, which was only 8 bits wide in ICMPv4, has been widened to 32 bits in ICMPv6, to provide more flexibility in isolating the error. The *Code* value is also used somewhat differently in ICMPv6 than it was in the ICMPv4 version of this message type. In ICMPv4, the *Pointer* was used only when the *Code* field was 0, and other code values indicated other problem categories for which the *Pointer* field did not make sense. In ICMPv6, the *Pointer* field is used with all *Code types*, to indicate the general nature of what the problem is. This means the *Pointer* field tells the recipient of the *Parameter Problem*

where in the message the problem happened, and the *Code* field tells it what the nature of the problem is. The following table shows the three *Code* values and provides a brief explanation of each:

Table 108: ICMPv6 *Parameter Problem* Message Interpretation Codes

Code Value	Message Subtype	Description
0	Erroneous Header Field Encountered	The <i>Pointer</i> field points to a header that contains an error or otherwise could not be processed.
1	Unrecognized Next Header Type Encountered	Recall that in IPv6 a datagram can have multiple headers, each of which contains a <i>Next Header</i> field that points to the next header in the datagram. This code indicates that the <i>Pointer</i> field points to a <i>Next Header</i> field containing an unrecognized value.
2	Unrecognized IPv6 Option Encountered	The <i>Pointer</i> field points to an IPv6 option that was not recognized by the processing device.



Key Concept: The ICMPv6 *Parameter Problem* message is a generic error message that can be used to convey an error of any type in an IP datagram. The *Pointer* field is used to indicate to the recipient of the message where the problem was in the original datagram.



ICMP Version 6 (ICMPv6) Informational Message Types and Formats

In the previous section we explored a number of ICMPv6 error messages, which are sent back to the originator of an IPv6 datagram when an error is detected in it that makes it impossible to be delivered. Just as was the case with the original version of ICMP (ICMPv4), ICMPv6 also defines another class of message: *informational* messages. These ICMPv6 messages are used not to report errors, but to allow the sharing of information required to implement various test, diagnostic and support functions critical to the operation of IPv6.

In this section I describe eight different ICMPv6 informational messages in five topics (six of these messages are used in matching pairs, and the pairs are described together). I begin by describing ICMPv6 *Echo Request* and *Echo Reply* messages, used for network connectivity testing. I explain the format of *Router Advertisement* and *Router Solicitation* messages, used to let hosts discover local routers and learn necessary parameters from them. I then describe ICMPv6 *Neighbor Advertisement* and *Neighbor Solicitation* messages, used for various communications between hosts on a local network, including IPv6 address resolution. I discuss IPv6 *Redirect* messages, which let routers inform hosts of better first-hop routers, and IPv6 *Router Renumbering* messages.

Several of the ICMPv6 informational messages include additional information that is either optional, recommended or mandatory, depending on the circumstances under which the message is generated. Some of these are shared between message types, so they are described in a separate topic at the end of the section.

In IPv4, the use of many of the ICMP informational messages was described in a variety of different standards. In IPv6, many of the functions using informational messages have been gathered together and formalized in the IPv6 *Neighbor Discovery (ND)* Protocol. The solicitation and advertisement of local routers and neighboring hosts, as well as communication of redirection information are both examples of activities for which ND is responsible. In fact, five of the ICMP messages described in this section are actually defined in the Neighbor Discovery standard, RFC 2461.

ND and ICMPv6 are obviously closely related, given that ND describes the use of several of the ICMP messages: *Router Advertisement*, *Router Solicitation*, *Neighbor Advertisement*, *Neighbor Solicitation* and *Redirect*. Thus, just as ICMPv4 is an important “assistant” to IPv4, both ICMPv6 and ND are important helpers for IPv6. In this Guide, I provide most of the description of how these messages are used in [the detailed section on ND](#). In this section, I provide only a brief summary of their use, while focusing primarily on message format and the meaning of each of the fields in that format.



Note: In ICMPv6, the *Redirect* message is informational, and no longer considered an error message [as it was in ICMPv4](#).

ICMPv6 Echo Request and Echo Reply Messages

IP is a relatively simple protocol that does not itself include any method for performing tests between devices to help in diagnosing internetwork problems. This means that this job, like other support tasks, falls to ICMP. The simplest test performed when there is a problem using TCP/IP is usually a check that a pair of devices is able to send datagrams to each other. This is most often done by an initiating device sending a test message to a second device, which receives it and replies back to tell the first device it received the message.

Like ICMPv4, ICMPv6 includes a pair of messages specifically for connection testing. To use them, Device *A* begins the test process by sending an ICMPv4 *Echo Request* message to Device *B*. Device *B* responds back to Device *A* with an *Echo Reply* message. When Device *A* receives this message, it knows that it is able to communicate (both send and receive) successfully with Device *B*.



Note: As a side note, in ICMPv4, the first message type was named just *Echo* but was often called *Echo Request* instead. In ICMPv6 they finally just added the “Request” to the message name and were done with it. A modest but useful improvement from a clarity standpoint.

ICMPv6 Echo and Echo Reply Message Format

The format for ICMPv6 *Echo Request* and *Echo Reply* messages is very similar to that of the ICMPv4 version, as shown in [Table 109](#) and [Figure 157](#).

Table 109: ICMPv6 Echo Request and Echo Reply Message Format

Field Name	Size (bytes)	Description
Type	1	Type: Identifies the ICMPv6 message type; for <i>Echo Request</i> messages the value is 128, and for <i>Echo Reply</i> messages 129. (Recall that in ICMPv6, informational messages always have a <i>Type</i> value of 128 or higher.)
Code	1	Code: Not used; set to 0.
Checksum	2	Checksum: 16-bit checksum field for the ICMP header, as described in the topic on the ICMP common message format .
Identifier	2	Identifier: An optional identification field that can be used to help in matching <i>Echo Request</i> and <i>Echo Reply</i> messages.
Sequence Number	2	Sequence Number: A sequence number to help in matching <i>Echo Request</i> and <i>Echo Reply</i> messages.
Optional Data	Variable	Optional Data: Additional optional data to be sent along with the message. If this is sent in the <i>Echo Request</i> it is copied into the <i>Echo Reply</i> to be sent back to the source.

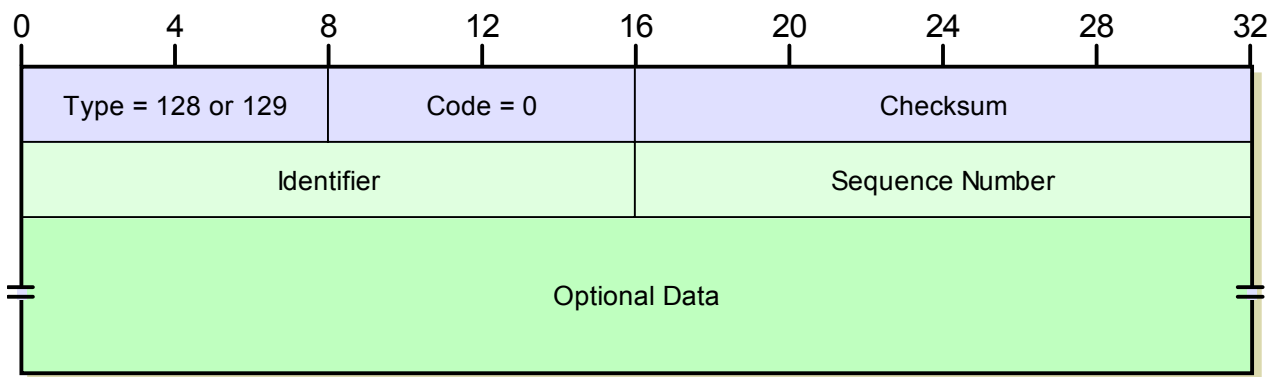

Figure 157: ICMPv6 Echo Request and Echo Reply Message Format

As with ICMPv4, it is often necessary to match an *Echo Reply* message with the *Echo Request* message that led to it being generated. Two special fields are used within the format of these messages to allow *Echo Request* and *Echo Reply* messages to be matched together, and to allow a sequence of messages to be exchanged. The *Identifier* field is provided so a particular test session can be identified, and the *Sequence Number* field allows a series of tests in a session to be numbered. The use of both fields is optional.

Application of Echo and Echo Reply Messages

ICMPv6 *Echo Request* and *Echo Reply* messages are used via the IPv6 version of the IP *ping* utility, commonly called *ping6*. Like its IPv4 predecessor this utility allows an administrator to configure a number of test options to perform either a simple or rigorous test of the connection between a pair of devices. See the topic describing *ping* for a full explanation.



Key Concept: ICMPv6 *Echo Request* and *Echo Reply* messages are used to facilitate network reachability testing. A device tests its ability to communicate with another by sending it an *Echo Request* message and waiting for an *Echo Reply* in response. The *ping* utility, a widely-used diagnostic tool in TCP/IP internetworks, makes use of these messages.

ICMPv6 Router Advertisement and Router Solicitation Messages

At the highest level, we can separate IP devices into two groups: hosts and routers. Both participate in the use of the internetwork, but they have different roles. An important IP principle related to this division is that routers take care of routing—moving data between networks—while hosts generally don't need to worry about this job. Hosts rely on the routers on their local networks to facilitate communication to all other hosts except those on the local network.

The implications of this are clear: a host cannot really use an internetwork until it knows the identity of at least one local router, and the method by which that router is to be used. In IPv4, a technique known as *router discovery* was invented, which provides a means by which a host can locate a router and learn important parameters related to the operation of the local network.

Router discovery in IPv6 works in a very similar manner, by having routers send *Router Advertisement* messages both on a regular basis and in response to hosts prompting for them using *Router Solicitation* messages. The router discovery function has been incorporated into the *Neighbor Discovery (ND)* protocol, where it is part of a larger class of tools that I call [host-router discovery functions](#).

ICMPv6 Router Advertisement Message Format

The formats of the ICMPv6 *Router Advertisement* and *Router Solicitation* messages are fairly similar to [their counterparts in ICMPv4](#). The main differences are in the parameters that are communicated. Since routers are responsible for a few more functions in IPv6 than they are in IPv4, the *Router Advertisement* message in ICMPv6 has a few more fields than the older version.

The format of an ICMPv6 *Router Advertisement* message is described in [Table 110](#) and shown in [Figure 158](#).

Table 110: ICMPv6 Router Advertisement Message Format (Page 1 of 2)

Field Name	Size (bytes)	Description
Type	1	Type: Identifies the ICMPv6 message type; for <i>Router Advertisement</i> messages the value is 134.
Code	1	Code: Not used; set to 0.
Checksum	2	Checksum: 16-bit checksum field for the ICMP header, as described in the topic on the ICMP common message format .
Cur Hop Limit	1	Current Hop Limit: This is a default value the router is telling hosts on the local network they should put in the <i>Hop Limit</i> field of datagrams they send. If 0, the router is not recommending a <i>Hop Limit</i> value in this <i>Router Advertisement</i> .

Table 110: ICMPv6 Router Advertisement Message Format (Page 2 of 2)

Field Name	Size (bytes)	Description												
Autoconfig Flags	1	<p>Autoconfiguration Flags: Two flags that let the router tell the host how autoconfiguration is performed on the local network. See the topic on IPv6 autoconfiguration for more details:</p> <table border="1"> <thead> <tr> <th>Subfield Name</th> <th>Size (bytes)</th> <th>Description</th> </tr> </thead> <tbody> <tr> <td>M</td> <td>1/8 (1 bit)</td> <td>Managed Address Configuration Flag: When set, this flag tells hosts to use an administered or “stateful” method for address autoconfiguration, such as DHCP.</td> </tr> <tr> <td>O</td> <td>1/8 (1 bit)</td> <td>Other Stateful Configuration Flag: When set, tells hosts to use an administered or “stateful” autoconfiguration method for information other than addresses.</td> </tr> <tr> <td>Reserved</td> <td>6/8 (6 bits)</td> <td>Reserved: Reserved for future use; sent as zeroes.</td> </tr> </tbody> </table>	Subfield Name	Size (bytes)	Description	M	1/8 (1 bit)	Managed Address Configuration Flag: When set, this flag tells hosts to use an administered or “stateful” method for address autoconfiguration, such as DHCP .	O	1/8 (1 bit)	Other Stateful Configuration Flag: When set, tells hosts to use an administered or “stateful” autoconfiguration method for information other than addresses.	Reserved	6/8 (6 bits)	Reserved: Reserved for future use; sent as zeroes.
Subfield Name	Size (bytes)	Description												
M	1/8 (1 bit)	Managed Address Configuration Flag: When set, this flag tells hosts to use an administered or “stateful” method for address autoconfiguration, such as DHCP .												
O	1/8 (1 bit)	Other Stateful Configuration Flag: When set, tells hosts to use an administered or “stateful” autoconfiguration method for information other than addresses.												
Reserved	6/8 (6 bits)	Reserved: Reserved for future use; sent as zeroes.												
Router Lifetime	2	<p>Router Lifetime: Tells the host receiving this message how long, in seconds, this router should be used as a default router. If 0, tells the host this router should not be used as a default router.</p> <p>Note that this is an expiration interval only for the status of the router as a default, not for other information in the <i>Router Advertisement</i> message.</p>												
Reachable Time	4	<p>Reachable Time: Tells hosts how long, in milliseconds, they should consider a neighbor to be reachable after they have received reachability confirmation. See the Neighbor Discovery topic discussing neighbor unreachability detection for more.</p>												
Retrans Timer	4	<p>Retransmission Timer: The amount of time, in milliseconds, that a host should wait before retransmitting Neighbor Solicitation messages.</p>												
Options	Variable	<p>Options: <i>Router Advertisement</i> messages may contain three possible options (see the topic on ICMPv6 options for details):</p> <ul style="list-style-type: none"> • Source Link-Layer Address: Included when the router sending the <i>Advertisement</i> knows its link-layer (layer two) address. • MTU: Used to tell local hosts the MTU of the local network when this information may not be known by hosts on the network. • Prefix Information: Tells local hosts what prefix or prefixes to use for the local network. (Recall that the “prefix” indicates which bits of an IPv6 address are the network identifier compared to the host identifier; it is thus analogous to an IPv4 subnet mask). 												

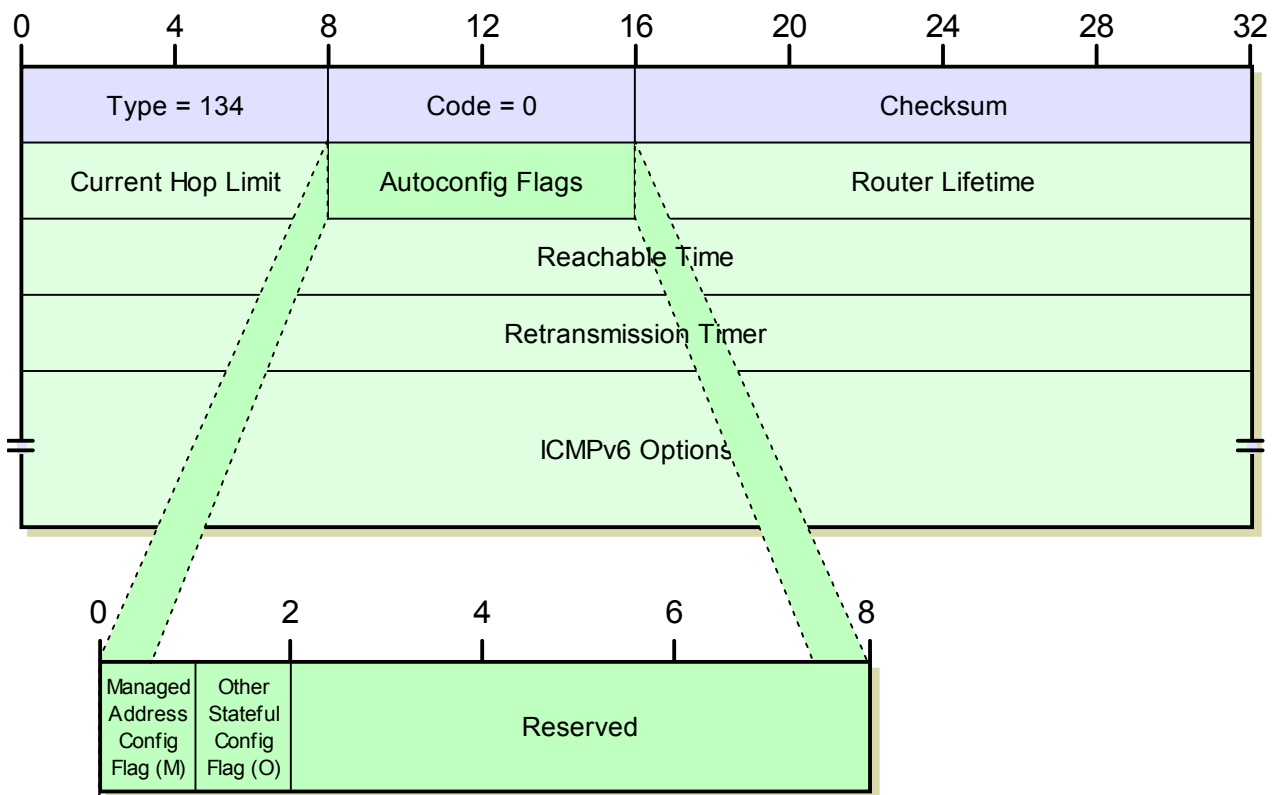

Figure 158: ICMPv6 Router Advertisement Message Format

ICMPv6 Router Solicitation Message Format

The format of an ICMPv6 Router Solicitation message is as shown [Table 111](#) and [Figure 159](#).

Table 111: ICMPv6 Router Solicitation Message Format

Field Name	Size (bytes)	Description
Type	1	Type: Identifies the ICMPv6 message type; for <i>Router Solicitation</i> messages the value is 133.
Code	1	Code: Not used; set to 0.
Checksum	2	Checksum: 16-bit checksum field for the ICMP header, as described in the topic on the ICMP common message format .
Reserved	4	Reserved: 4 reserved bytes set to 0.
Options	Variable	Options: If the device sending the <i>Router Solicitation</i> knows its layer two address, it should be included in a <i>Source Link-Layer Address</i> option. Option formats are described in a separate topic .

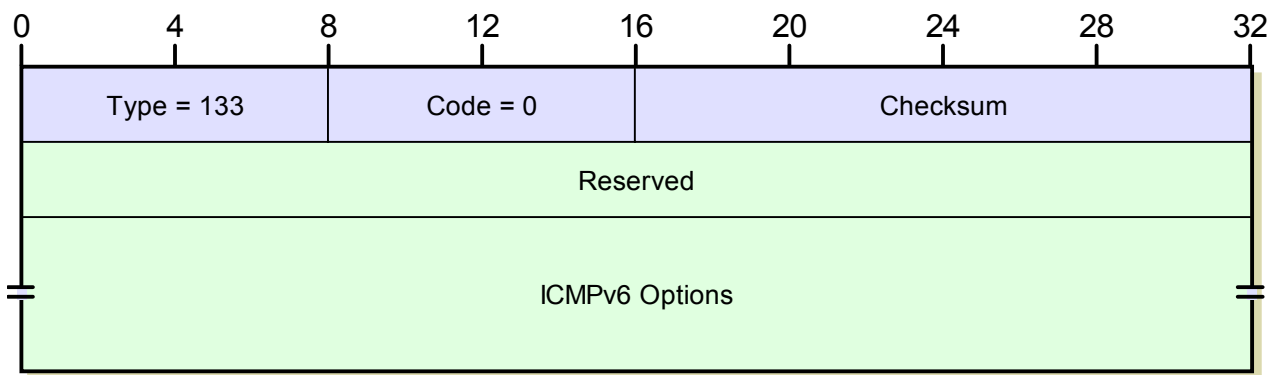

Figure 159: ICMPv6 Router Solicitation Message Format

Addressing of Router Advertisement and Router Solicitation Messages

Router Solicitation messages are normally sent to the IPv6 “all routers” multicast address; this is the most efficient method since routers are required to subscribe to this multicast address while hosts will ignore it. A routine (unsolicited) *Router Advertisement* is sent to all devices using the “all nodes” multicast address for the local network. A *Router Advertisement* that is sent in response to a *Router Solicitation* goes unicast back to the device that sent the solicitation.



Key Concept: ICMPv6 *Router Advertisement* messages are sent regularly by IPv6 routers to inform hosts of their presence and characteristics, and to provide hosts with parameters they need to function properly on the local network. A host that wants to find out immediately what routers are present may send a *Router Solicitation*, which will prompt listening routers to send out *Router Advertisements*.

ICMPv6 Neighbor Advertisement and Neighbor Solicitation Messages

The previous topic described the *Router Advertisement* and *Router Solicitation* messages, which are used to facilitate host-router discovery functions as part of the IPv6 Neighbor Discovery (ND) protocol. The other main group of tasks for which ND is responsible relates to the exchange of information between neighboring hosts on the same network. I call these *host-host communication* or *host-host discovery* functions.

Arguably, the most important additions to the Neighbor Discovery protocol are the functions that formalize the exchange of parameters, and the methods for determining the existence of neighboring hosts. These tasks include the new method of address resolution in IPv6, as well the processes of next-hop determination and neighbor unreachability detection. They require the use of two ICMPv6 messages: the *Neighbor Solicitation* message and the *Neighbor Advertisement* message.

The *Neighbor Solicitation* message allows a device to check that a neighbor exists and is reachable, and to initiate address resolution. The *Neighbor Advertisement* message confirms the existence of a host or router, and also provides layer-two address information when needed. As you can see, these two messages are comparable to the *Router Advertisement* and *Router Solicitation* messages, but are used differently and include different parameters.

ICMPv6 Neighbor Advertisement Message Format

The format for the *Neighbor Advertisement* message is described in [Table 112](#) and [Figure 160](#).

Table 112: ICMPv6 Neighbor Advertisement Message Format (Page 1 of 2)

Field Name	Size (bytes)	Description															
Type	1	Type: Identifies the ICMPv6 message type; for <i>Neighbor Advertisement</i> messages the value is 136.															
Code	1	Code: Not used; set to 0.															
Checksum	2	Checksum: 16-bit checksum field for the ICMP header, as described in the topic on the ICMP common message format .															
Flags	4	Flags: Three flags that convey information about the message (and lots of empty space for future use):															
		<table border="1"> <thead> <tr> <th>Subfield Name</th> <th>Size (bytes)</th> <th>Description</th> </tr> </thead> <tbody> <tr> <td>R</td> <td>1/8 (1 bit)</td> <td>Router Flag: Set when a router sends a <i>Neighbor Advertisement</i>, and cleared when a host sends one. This identifies the type of device that sent the datagram, and is also used as part of Neighbor Unreachability Detection to detect when a device changes from acting as a router to functioning as a regular host.</td> </tr> <tr> <td>S</td> <td>1/8 (1 bit)</td> <td>Solicited Flag: When set, indicates that this message was sent in response to a <i>Neighbor Solicitation</i> message. Cleared for unsolicited <i>Neighbor Advertisements</i>.</td> </tr> <tr> <td>O</td> <td>1/8 (1 bit)</td> <td>Override Flag: When set, tells the recipient that the information in this message should override any existing cached entry for the link-layer address of this device. This bit is normally set in unsolicited <i>Neighbor Advertisements</i> since these are sent when a host needs to force a change of information in the caches of its neighbors.</td> </tr> <tr> <td>Reserved</td> <td>3 5/8 (29 bits)</td> <td>Reserved: A big whopping set of reserved bits. ☺</td> </tr> </tbody> </table>	Subfield Name	Size (bytes)	Description	R	1/8 (1 bit)	Router Flag: Set when a router sends a <i>Neighbor Advertisement</i> , and cleared when a host sends one. This identifies the type of device that sent the datagram, and is also used as part of Neighbor Unreachability Detection to detect when a device changes from acting as a router to functioning as a regular host.	S	1/8 (1 bit)	Solicited Flag: When set, indicates that this message was sent in response to a <i>Neighbor Solicitation</i> message. Cleared for unsolicited <i>Neighbor Advertisements</i> .	O	1/8 (1 bit)	Override Flag: When set, tells the recipient that the information in this message should override any existing cached entry for the link-layer address of this device. This bit is normally set in unsolicited <i>Neighbor Advertisements</i> since these are sent when a host needs to force a change of information in the caches of its neighbors.	Reserved	3 5/8 (29 bits)	Reserved: A big whopping set of reserved bits. ☺
		Subfield Name	Size (bytes)	Description													
		R	1/8 (1 bit)	Router Flag: Set when a router sends a <i>Neighbor Advertisement</i> , and cleared when a host sends one. This identifies the type of device that sent the datagram, and is also used as part of Neighbor Unreachability Detection to detect when a device changes from acting as a router to functioning as a regular host.													
		S	1/8 (1 bit)	Solicited Flag: When set, indicates that this message was sent in response to a <i>Neighbor Solicitation</i> message. Cleared for unsolicited <i>Neighbor Advertisements</i> .													
O	1/8 (1 bit)	Override Flag: When set, tells the recipient that the information in this message should override any existing cached entry for the link-layer address of this device. This bit is normally set in unsolicited <i>Neighbor Advertisements</i> since these are sent when a host needs to force a change of information in the caches of its neighbors.															
Reserved	3 5/8 (29 bits)	Reserved: A big whopping set of reserved bits. ☺															

Table 112: ICMPv6 Neighbor Advertisement Message Format (Page 2 of 2)

Field Name	Size (bytes)	Description
Target Address	16	<p>Target Address: If the <i>Neighbor Advertisement</i> is being sent in response to a <i>Neighbor Solicitation</i>, this is the same value as in the <i>Target Address</i> field of the <i>Solicitation</i>. This field will commonly contain the IPv6 address of the device sending the <i>Neighbor Advertisement</i>, but not in all cases. For example, if a device responds as a proxy for the target of the <i>Neighbor Solicitation</i>, the <i>Target Address</i> field contains the address of the target, not the device sending the response. See the topic on address resolution proxying for details.</p> <p>If the <i>Neighbor Advertisement</i> is being sent unsolicited, then this is the IPv6 address of the device sending it.</p>
Options	Variable	<p>Options: When sent in response to a multicast <i>Neighbor Solicitation</i>, a <i>Neighbor Advertisement</i> message must contain a <i>Target Link-Layer Address</i> option, which carries the link-layer address of the device sending the message. This is a good example of an “option” that’s not really “optional”. ☺</p> <p>When the <i>Neighbor Advertisement</i> is sent in response to a unicast <i>Neighbor Solicitation</i>, this option is technically not required (since the sender of the <i>Solicitation</i> must already have the target’s link-layer address to have sent it unicast.) Despite this, it is still normally included, to ensure that the link-layer address of the target is refreshed in the cache of the device that sent the <i>Neighbor Solicitation</i>.</p>

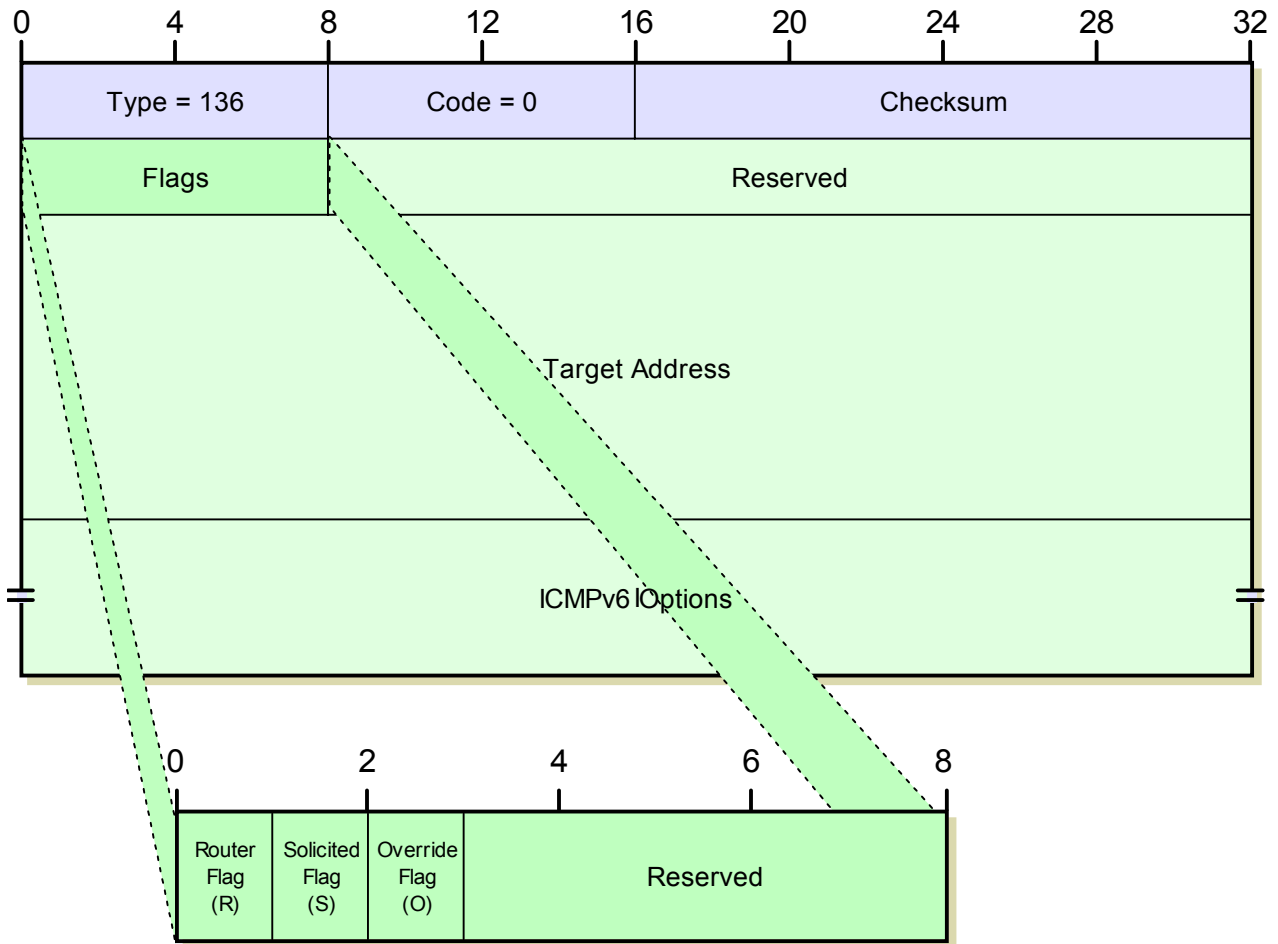

Figure 160: ICMPv6 Neighbor Advertisement Message Format

ICMPv6 Neighbor Solicitation Message Format

The *Neighbor Solicitation* message format is much simpler, as depicted in [Table 113](#) and [Figure 161](#).

Table 113: ICMPv6 Neighbor Solicitation Message Format (Page 1 of 2)

Field Name	Size (bytes)	Description
Type	1	Type: Identifies the ICMPv6 message type; for <i>Neighbor Solicitation</i> messages the value is 135.
Code	1	Code: Not used; set to 0.
Checksum	2	Checksum: 16-bit checksum field for the ICMP header, as described in the topic on the ICMP common message format .
Reserved	4	Reserved: 4 reserved bytes set to 0.

Table 113: ICMPv6 Neighbor Solicitation Message Format (Page 2 of 2)

Field Name	Size (bytes)	Description
Target Address	16	Target Address: The IPv6 address of the target of the solicitation. For IPv6 address resolution, this is the actual unicast IP address of the device whose layer two (link-layer) address we are trying to resolve.
Options	Variable	Options: If the device sending the <i>Neighbor Solicitation</i> knows both its own IP address and layer two address, it should include the layer two address in a <i>Source Link-Layer Address</i> option. The inclusion of this option will allow the destination of the <i>Neighbor Solicitation</i> to enter the layer two and layer three addresses of the source of this message into its own address cache. See the discussion of IPv6 address resolution.

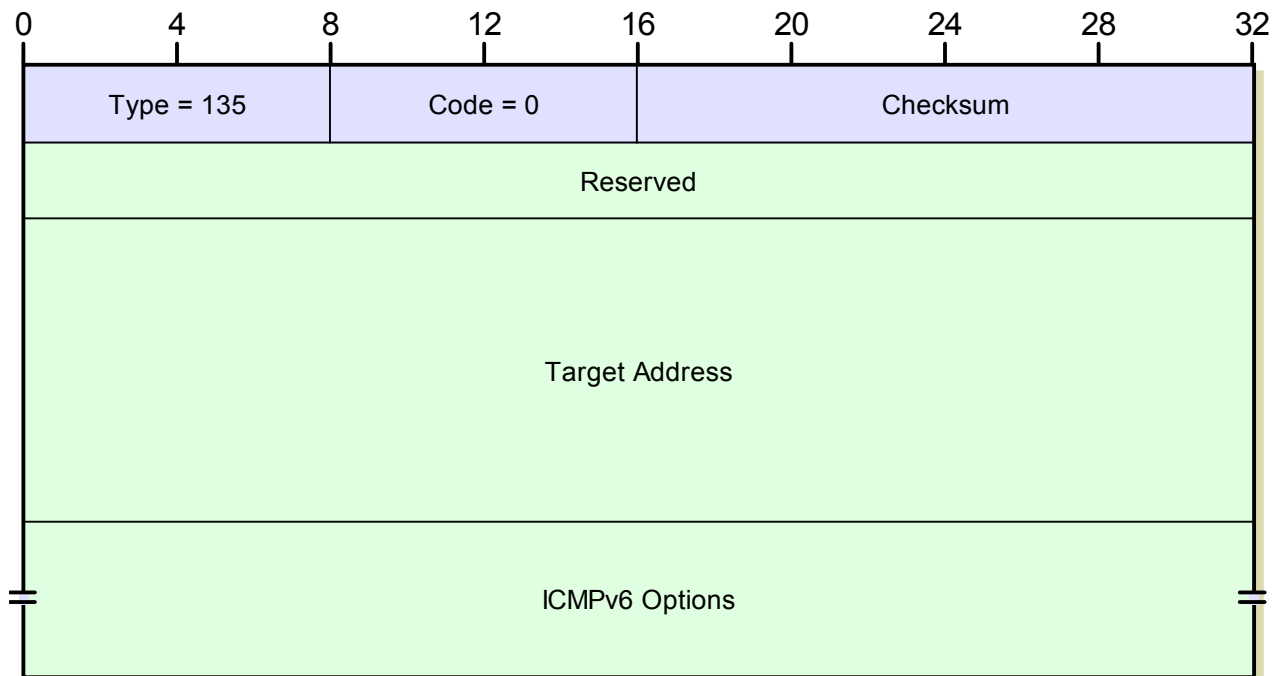

Figure 161: ICMPv6 Neighbor Solicitation Message Format



Key Concept: ICMPv6 *Neighbor Advertisement* and *Neighbor Solicitation* messages are similar in many ways to the Router Advertisement and Router Solicitation messages. However, rather than being used to communicate parameters from routers to hosts, they are used for various types of communication between hosts on a physical network, such as address resolution, next-hop determination and neighbor unreachability detection.

Addressing of Neighbor Advertisement and Neighbor Solicitation Messages

Neighbor Solicitation messages are sent either unicast to the address of the target device, or to the solicited-node multicast address of the target. This latter address is a special type used to allow a device to send a multicast that will be heard by the target whose address it is trying to resolve, but won't be heard by most other devices; [it is explained in the topic on IPv6 address resolution](#).

When a *Neighbor Advertisement* message is generated in response to a *Neighbor Solicitation*, it is sent unicast back to the device that sent the *Solicitation*, unless that message was sent from [the unspecified address](#), in which case it is multicast to the “all nodes” multicast address. If the *Neighbor Advertisement* message is sent unsolicited (for example, by a device that wishes to inform others of a change in link-layer address), it is sent to the “all nodes” multicast address.

ICMPv6 Redirect Messages

Because of the different roles of routers and hosts in an IPv6 internetwork, hosts don't need to know very much about routes. They send datagrams intended for destinations on the local network directly, while those for other networks they dump to their local routers and let them “do the driving”, so to speak.

If a local network has only a single router, then it will send all such non-local traffic to that router. If it has more than one local router, the host then must decide which router to use for which traffic. In general terms, a host will not know the most efficient choice of router for every type of datagram it may need to send. In fact, many nodes start out with a limited routing table that says to send **everything** to a single default router, even if there are several routers on the network.

When a router receives datagrams destined for certain networks, it may realize that it would be more efficient if such traffic was sent by a host to a different router on the local network. If so, it will invoke the *Redirect* function by sending an ICMPv6 *Redirect* message to the device that sent the original datagram. This is the last of the functions that in IPv6 are performed by the Neighbor Discovery protocol, and is explained in [a topic on the Redirect function in that section](#). *Redirect* messages are always sent unicast to the address of the device that originally sent the datagram that led to the *Redirect* being created.

ICMPv6 Redirect Message Format

The format of ICMPv6 *Redirect* messages is shown in [Table 114](#) and [Figure 162](#).

Table 114: ICMPv6 Redirect Message Format (Page 1 of 2)

Field Name	Size (bytes)	Description
<i>Type</i>	1	Type: Identifies the ICMPv6 message type; for <i>Redirect</i> messages the value is 137.
<i>Code</i>	1	Code: Not used; set to 0.

Table 114: ICMPv6 *Redirect* Message Format (Page 2 of 2)

Field Name	Size (bytes)	Description
Checksum	2	Checksum: 16-bit checksum field for the ICMP header, as described in the topic on the ICMP common message format .
Reserved	4	Reserved: 4 bytes sent as zeroes.
Target Address	16	Target Address: The address of the router that the router creating the <i>Redirect</i> is telling the recipient of the <i>Redirect</i> to use as a first hop for future transmissions to the destination. Phew. Example time: if router <i>R2</i> generated a <i>Redirect</i> telling host <i>A</i> that in the future transmissions to host <i>B</i> should be sent first to router <i>R1</i> , then <i>R1</i> 's IPv6 address would be in this field.
Destination Address	16	Destination Address: The address of the device whose future transmissions are being redirected; this is the destination of the datagram that originally led to the <i>Redirect</i> being generated. Repeating the example above: if router <i>R2</i> generated a <i>Redirect</i> telling host <i>A</i> that in the future transmissions to host <i>B</i> should be sent first to router <i>R1</i> , then host <i>B</i> 's IPv6 address would be in this field.
Options	Variable	Options: Redirect messages normally include two ICMPv6 option fields : <ul style="list-style-type: none"> • Target Link-Layer Address: The layer-two address of the <i>Target Address</i>, if known. This saves the recipient of the <i>Redirect</i> message from needing to perform an address resolution on the target. • Redirected Header: As much of the IPv6 datagram that spawned this <i>Redirect</i> as will fit without causing the size of the ICMPv6 error message (including its own IP header) to exceed the minimum IPv6 maximum transmission unit (MTU) of 1280 bytes.



Note: As an aside, the *Redirect* message has always been somewhat of an oddball. In ICMPv4, [it is considered an error message](#), but this makes it different from other error messages. For one thing, it's not really an error, since it doesn't represent a failure to deliver, only an inefficiency in doing so. For this reason, in ICMPv6 it was "moved" to the set of informational message types. Here too it doesn't really fit in with the others, since it is sent in reaction to a regular IP message, and it also includes a copy of (part of) the datagram that spawned it, like error messages do.



Key Concept: ICMPv6 *Redirect* messages are used by a router to inform a host of a better router to use for future datagrams sent to a particular host or network. They are not used to alter routes between routers, however.

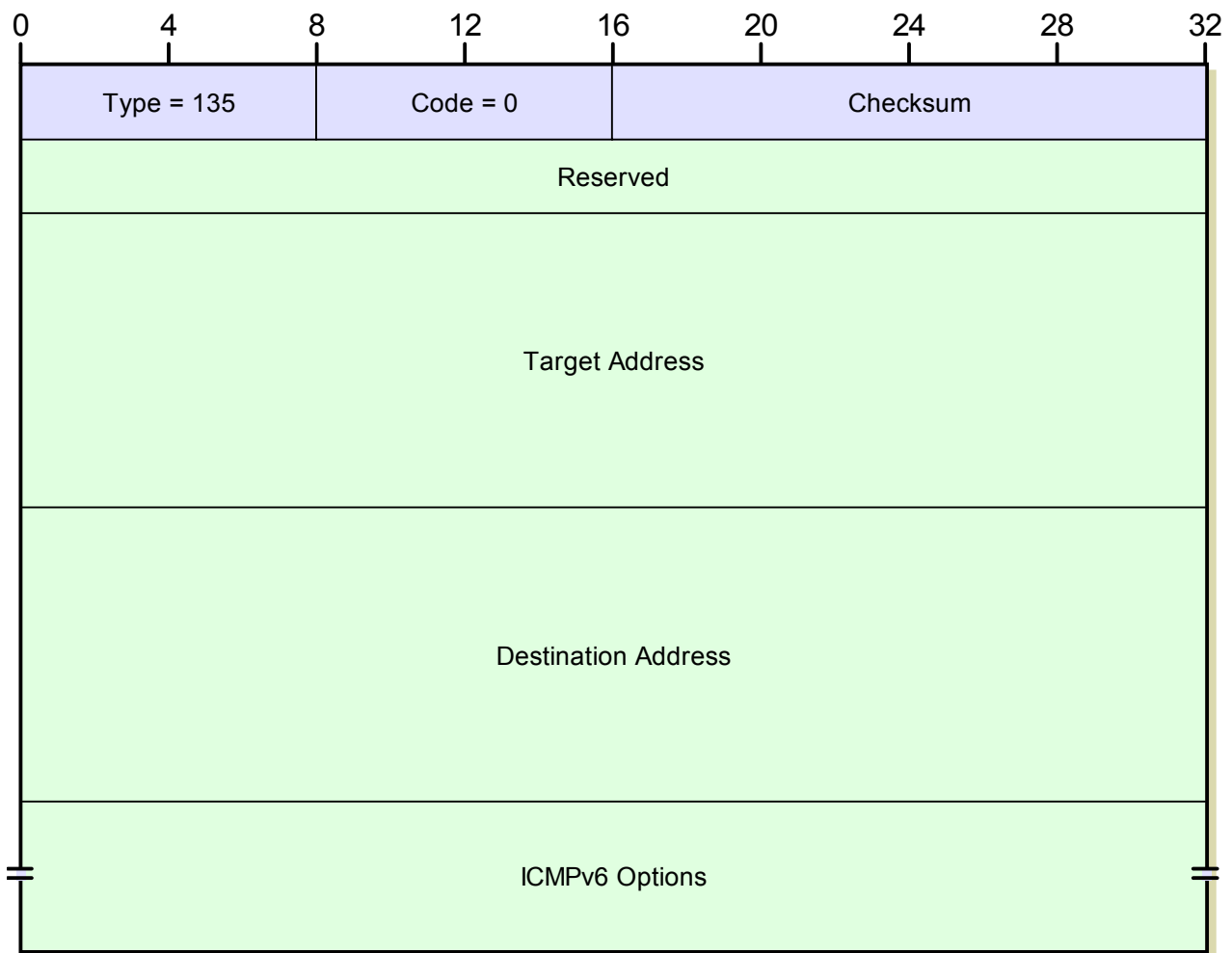

Figure 162: ICMPv6 *Redirect* Message Format

ICMPv6 Router Renumbering Messages

One of the more interesting decisions made in IPv6 was the selection of a [very large 128-bit address size](#). This provides an address space far larger than what humans are ever likely to need—and probably larger than was needed for IPv6, strictly speaking. What this wealth of bits provides is the flexibility to assign meaning to different bits in the address structure. This in turn serves as the basis for important features such as the [autoconfiguration and automated renumbering of IPv6 addresses](#).

The renumbering feature in IPv6 is of particular interest to network administrators, since it has the potential to make large network migrations and merges much simpler. In August 2000, the IETF published RFC 2894, *Router Renumbering for IPv6*, which describes a similar technique to allow routers in an autonomous system to be renumbered, by giving them new prefixes (network identifiers).

Router renumbering is actually a fairly simple process—especially if we avoid the gory details, which is exactly what I intend to do. A network administrator uses a device on the internetwork to generate one or more *Router Renumbering Command* messages. These messages provide a list of prefixes of routers that are to be renumbered. Each router processes these messages to see if the addresses on any of their interfaces match the specified prefixes. If so, they change the matched prefixes to the new ones specified in the message. Additional information is also included in the *Router Renumbering Command* as appropriate to control how and when the renumbering is done.

If the *Command* message requests it, each router processing the message will respond with a *Router Renumbering Result* message. This message serves as feedback to let the originator of the *Command* know whether the renumbering was successful, and what changes, if any, were made.

The router renumbering standard also defines a few important management features. Many of these reflect the great power of something that can mass-renumber routers—and hence, the potential for such power to be abused. It is possible to send commands in a “test mode”, where they are processed but the renumbering not actually executed. Messages include a sequence number to guard against replay attacks, and a special *Sequence Number Reset* message can be used to reset the sequence number information routers have previously stored. For added security, the standard specifies that messages be authenticated and identity-checked.

ICMPv6 Router Renumbering Message Format

The format of *Router Renumbering* messages is in [Table 115](#) and [Figure 163](#).

Table 115: ICMPv6 Router Renumbering Message Format (Page 1 of 3)

Field Name	Size (bytes)	Description								
Type	1	Type: Identifies the ICMPv6 message type; for <i>Router Renumbering</i> messages the value is 138.								
Code	1	Code: Indicates the subtype of <i>Router Renumbering</i> message: <table border="1" style="margin-left: 20px;"> <thead> <tr> <th>Value (Decimal)</th> <th>Message Subtype</th> </tr> </thead> <tbody> <tr> <td>0</td> <td><i>Router Renumbering Command</i></td> </tr> <tr> <td>1</td> <td><i>Router Renumbering Result</i></td> </tr> <tr> <td>255</td> <td><i>Sequence Number Reset</i></td> </tr> </tbody> </table>	Value (Decimal)	Message Subtype	0	<i>Router Renumbering Command</i>	1	<i>Router Renumbering Result</i>	255	<i>Sequence Number Reset</i>
Value (Decimal)	Message Subtype									
0	<i>Router Renumbering Command</i>									
1	<i>Router Renumbering Result</i>									
255	<i>Sequence Number Reset</i>									
Checksum	2	Checksum: 16-bit checksum field for the ICMP header, as described in the topic on the ICMP common message format .								
Sequence Number	4	Sequence Number: A 32-bit sequence number used to guard against “replay” attacks by allowing a recipient to detect stale, duplicate or “out of order” commands.								

Table 115: ICMPv6 Router Renumbering Message Format (Page 2 of 3)

Field Name	Size (bytes)	Description																					
Segment Number	1	Segment Number: Differentiates between valid <i>Router Renumbering</i> messages within the same <i>Sequence Number</i> .																					
Flags	1	Flags: Five flags used to control the renumbering process. The first four flags (<i>T</i> , <i>R</i> , <i>A</i> and <i>S</i>) control the operation of <i>Command</i> messages and in a <i>Result</i> message are just copied verbatim from the <i>Command</i> that led to the <i>Result</i> being created. The <i>P</i> flag is only used in <i>Result</i> messages (0 in <i>Command</i> messages):																					
		<table border="1"> <thead> <tr> <th>Subfield Name</th> <th>Size (bytes)</th> <th>Description</th> </tr> </thead> <tbody> <tr> <td><i>T</i></td> <td>1/8 (1 bit)</td> <td>Test Command Flag: When set to 1, flags this <i>Command</i> as being a test message. This tells the recipient to only "simulate" processing of the renumber and not actually do it.</td> </tr> <tr> <td><i>R</i></td> <td>1/8 (1 bit)</td> <td>Result Requested Flag: When set to 1, requests that a <i>Result</i> message be sent after processing the <i>Command</i>, when 0, says not to send one.</td> </tr> <tr> <td><i>A</i></td> <td>1/8 (1 bit)</td> <td>All Interfaces Flag: When this flag is clear (0), the <i>Command</i> is not applied to any router interfaces that have been administratively shut down. When 1, it is applied to all interfaces.</td> </tr> <tr> <td><i>S</i></td> <td>1/8 (1 bit)</td> <td>Site-Specific Flag: This flag has meaning only when a router treats its interfaces as belonging to different sites. If so, a value of 1 tells it to apply the <i>Command</i> only to interfaces on the same site as the interface for which the <i>Command</i> was received. A value of 0 applies it to all interfaces regardless of site.</td> </tr> <tr> <td><i>P</i></td> <td>1/8 (1 bit)</td> <td>Processed Previously Flag: This flag is normally 0, meaning the <i>Command</i> was not previously seen and the <i>Result</i> message contains the report of processing it. When 1, indicates that the recipient of the <i>Command</i> believes it has seen it before and is not processing it. (Test commands are not included in the assessment of whether a <i>Command</i> has been seen before.)</td> </tr> <tr> <td><i>Reserved</i></td> <td>3/8 (3 bits)</td> <td>Reserved: Three bits reserved for future flags.</td> </tr> </tbody> </table>	Subfield Name	Size (bytes)	Description	<i>T</i>	1/8 (1 bit)	Test Command Flag: When set to 1, flags this <i>Command</i> as being a test message. This tells the recipient to only "simulate" processing of the renumber and not actually do it.	<i>R</i>	1/8 (1 bit)	Result Requested Flag: When set to 1, requests that a <i>Result</i> message be sent after processing the <i>Command</i> , when 0, says not to send one.	<i>A</i>	1/8 (1 bit)	All Interfaces Flag: When this flag is clear (0), the <i>Command</i> is not applied to any router interfaces that have been administratively shut down. When 1, it is applied to all interfaces.	<i>S</i>	1/8 (1 bit)	Site-Specific Flag: This flag has meaning only when a router treats its interfaces as belonging to different sites. If so, a value of 1 tells it to apply the <i>Command</i> only to interfaces on the same site as the interface for which the <i>Command</i> was received. A value of 0 applies it to all interfaces regardless of site.	<i>P</i>	1/8 (1 bit)	Processed Previously Flag: This flag is normally 0, meaning the <i>Command</i> was not previously seen and the <i>Result</i> message contains the report of processing it. When 1, indicates that the recipient of the <i>Command</i> believes it has seen it before and is not processing it. (Test commands are not included in the assessment of whether a <i>Command</i> has been seen before.)	<i>Reserved</i>	3/8 (3 bits)	Reserved: Three bits reserved for future flags.
		Subfield Name	Size (bytes)	Description																			
		<i>T</i>	1/8 (1 bit)	Test Command Flag: When set to 1, flags this <i>Command</i> as being a test message. This tells the recipient to only "simulate" processing of the renumber and not actually do it.																			
		<i>R</i>	1/8 (1 bit)	Result Requested Flag: When set to 1, requests that a <i>Result</i> message be sent after processing the <i>Command</i> , when 0, says not to send one.																			
		<i>A</i>	1/8 (1 bit)	All Interfaces Flag: When this flag is clear (0), the <i>Command</i> is not applied to any router interfaces that have been administratively shut down. When 1, it is applied to all interfaces.																			
		<i>S</i>	1/8 (1 bit)	Site-Specific Flag: This flag has meaning only when a router treats its interfaces as belonging to different sites. If so, a value of 1 tells it to apply the <i>Command</i> only to interfaces on the same site as the interface for which the <i>Command</i> was received. A value of 0 applies it to all interfaces regardless of site.																			
		<i>P</i>	1/8 (1 bit)	Processed Previously Flag: This flag is normally 0, meaning the <i>Command</i> was not previously seen and the <i>Result</i> message contains the report of processing it. When 1, indicates that the recipient of the <i>Command</i> believes it has seen it before and is not processing it. (Test commands are not included in the assessment of whether a <i>Command</i> has been seen before.)																			
<i>Reserved</i>	3/8 (3 bits)	Reserved: Three bits reserved for future flags.																					
Max Delay	2	Maximum Delay: Tells a router receiving a message the maximum amount of time (in milliseconds) it is allowed to delay before sending a reply.																					

Table 115: ICMPv6 Router Renumbering Message Format (Page 3 of 3)

Field Name	Size (bytes)	Description
Reserved	4	Reserved: 4 reserved bytes.
Message Body	Variable	<p>Message Body: For a <i>Router Renumbering Command</i>, the message body contains two sets of information. The first is a <i>Match-Prefix Part</i> for the prefix being renumbered. The second is one or more <i>Use-Prefix Parts</i> that describe the new prefix for each match. A router receiving a <i>Command</i> checks its own interface addresses and if they match the <i>Match-Prefix-Part</i>, they use <i>Use-Prefix Parts</i> data to accomplish the renumbering.</p> <p>For a <i>Router Renumbering Result</i>, the message body contains zero or more <i>Match Results</i> entries that describe each prefix that a router matched from a <i>Router Renumbering Command</i>. Each entry provides information regarding whether renumbering was successful or not for a prefix.</p>

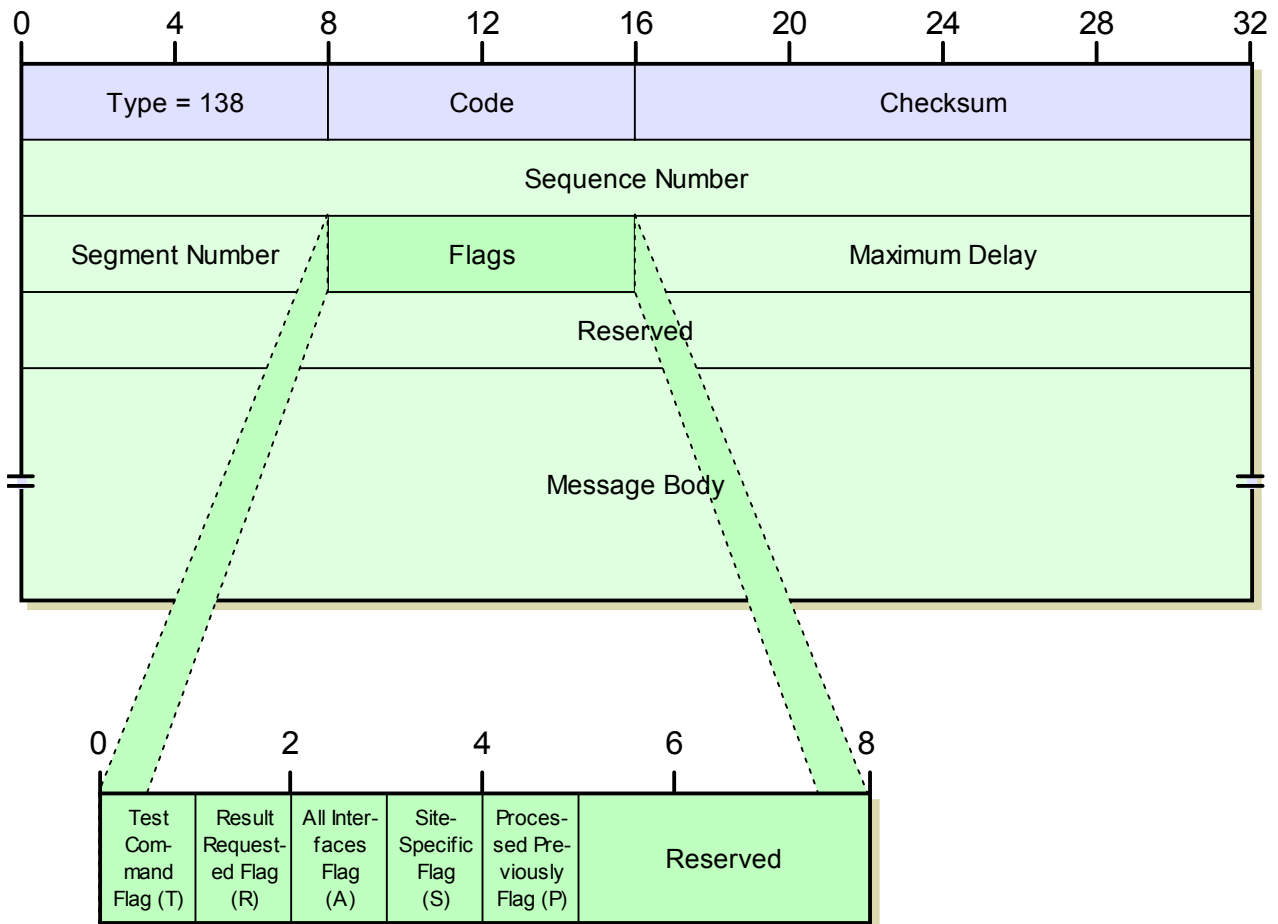

Figure 163: ICMPv6 Router Renumbering Message Format

Addressing of Router Renumbering Messages

Since these messages are intended for all routers on a site, they are normally sent to the “all routers” multicast address, using either [link-local](#) or [site-local scope](#). They may also be sent to local unicast addresses.

ICMPv6 Informational Message Options

Each of the five ICMPv6 informational messages types defined and used by the [Neighbor Discovery \(ND\) protocol](#) has an [Options](#) field into which one or more options may be inserted. This probably isn't the best name for these sets of data, since they are only optional in certain cases. In fact, in some cases the “option” is actually the entire point of the message. For example, a *Neighbor Advertisement* message containing a link-layer address for address resolution carries it in an “option”, but the message wouldn't be of much use without it.

Each option has its own structure of subfields based on the classical “type, length and value” triplet used in many message formats. The *Type* subfield indicates the option type and the *Length* field indicates its length so the device processing the option can determine where it ends. The “value” is not a single field, but rather one or more that contain the actual information for which the option is being used.

Some options are used for only one kind of ICMPv6 message, while others are used for more than one variety. So, they are best thought of as “modular components” used in different types of messages as needed. I describe the format of each of these five options below.

Source Link-Layer Address Option Format

This option carries the link-layer address of a device sending an ICMPv6 message, as shown in [Table 116](#) and [Figure 164](#). Used in *Router Advertisement*, *Router Solicitation* and *Neighbor Solicitation* messages:

Table 116: ICMPv6 Source Link-Layer Address Option Format

Field Name	Size (bytes)	Description
<i>Type</i>	1	Type: Identifies the ICMPv6 option type. For the <i>Source Link-Layer Address</i> option, the value is 1.
<i>Length</i>	1	Length: The length of the entire option (including the <i>Type</i> and <i>Length</i> fields), expressed in units of 8 octets (64 bits).
<i>Source Link-Layer Address</i>	Variable	Source Link-Layer Address: The link-layer (layer two) address of the device sending the ICMPv6 message.

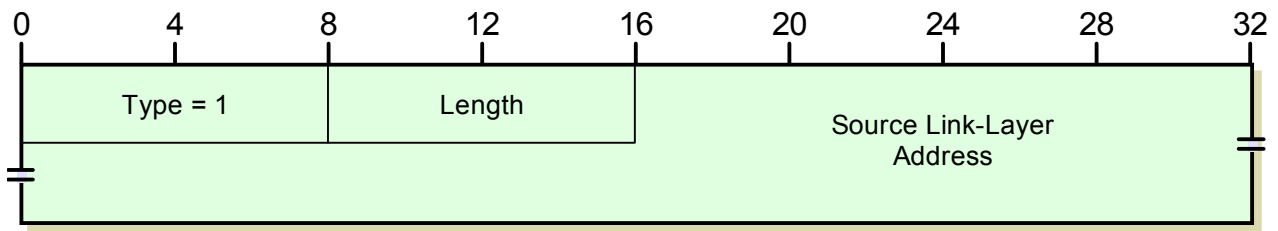

Figure 164: ICMPv6 Source Link-Layer Address Option Format

Target Link-Layer Address Option Format

The counterpart of *Source Link-Layer Address*, this option carries the link-layer address corresponding to the *Target Address* field in *Neighbor Advertisement* and *Redirect* messages; see [Table 117](#) and [Figure 165](#).

Table 117: ICMPv6 Target Link-Layer Address Option Format

Field Name	Size (bytes)	Description
Type	1	Type: Identifies the ICMPv6 option type. For the <i>Target Link-Layer Address</i> option, the value is 2.
Length	1	Length: The length of the entire option (including the <i>Type</i> and <i>Length</i> fields), expressed in units of 8 octets (64 bits).
Target Link-Layer Address	Variable	Target Link-Layer Address: The link-layer (layer two) address of the target device.

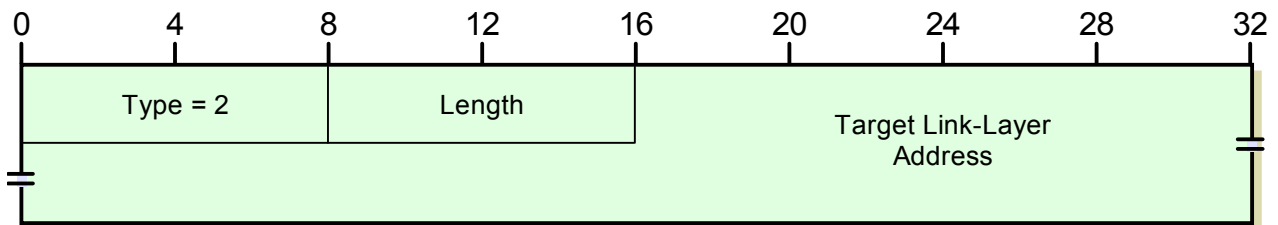

Figure 165: ICMPv6 Target Link-Layer Address Option Format

Prefix Information Option Format

This option provides a prefix and related information in *Router Advertisement* messages. This is the longest and most complex of the options, as you can see in [Table 118](#) and [Figure 166](#).

Table 118: ICMPv6 Prefix Information Option Format (Page 1 of 2)

Field Name	Size (bytes)	Description												
Type	1	Type: Identifies the ICMPv6 option type. For the <i>Prefix Information</i> option, the value is 3.												
Length	1	Length: The length of the entire option (including the <i>Type</i> and <i>Length</i> fields), expressed in units of 8 octets (64 bits). The <i>Prefix Information</i> option is fixed in size at 32 bytes, so the value of the <i>Length</i> field is 4.												
Prefix Length	1	Prefix Length: The number of bits in the <i>Prefix</i> field (below) that are considered part of the network identifier (the remainder are used for the host identifier and ignored). See this overview discussion of IPv6 address notation for details on prefix lengths.												
Flags	1	<p>Flags: A pair of flags that convey information about the prefix:</p> <table border="1"> <thead> <tr> <th>Subfield Name</th> <th>Size (bytes)</th> <th>Description</th> </tr> </thead> <tbody> <tr> <td>L</td> <td>1/8 (1 bit)</td> <td>On-Link Flag: When set to 1, tells the recipient of the option that this prefix can be used for on-link determination. This means the prefix can be used for deciding whether or not an address is “on-link” (on the recipient’s local network). When 0, the sender is making no statement regarding whether the prefix can be used for this or not.</td> </tr> <tr> <td>A</td> <td>1/8 (1 bit)</td> <td>Autonomous Address-Configuration Flag: When set to 1, specifies that this prefix can be used for IPv6 address autoconfiguration.</td> </tr> <tr> <td>Reserved</td> <td>6/8 (6 bits)</td> <td>Reserved: 6 “leftover” bits reserved and sent as zeroes.</td> </tr> </tbody> </table>	Subfield Name	Size (bytes)	Description	L	1/8 (1 bit)	On-Link Flag: When set to 1, tells the recipient of the option that this prefix can be used for on-link determination. This means the prefix can be used for deciding whether or not an address is “on-link” (on the recipient’s local network). When 0, the sender is making no statement regarding whether the prefix can be used for this or not.	A	1/8 (1 bit)	Autonomous Address-Configuration Flag: When set to 1, specifies that this prefix can be used for IPv6 address autoconfiguration .	Reserved	6/8 (6 bits)	Reserved: 6 “leftover” bits reserved and sent as zeroes.
Subfield Name	Size (bytes)	Description												
L	1/8 (1 bit)	On-Link Flag: When set to 1, tells the recipient of the option that this prefix can be used for on-link determination. This means the prefix can be used for deciding whether or not an address is “on-link” (on the recipient’s local network). When 0, the sender is making no statement regarding whether the prefix can be used for this or not.												
A	1/8 (1 bit)	Autonomous Address-Configuration Flag: When set to 1, specifies that this prefix can be used for IPv6 address autoconfiguration .												
Reserved	6/8 (6 bits)	Reserved: 6 “leftover” bits reserved and sent as zeroes.												
Valid Lifetime	4	Valid Lifetime: The amount of time, in seconds, that the recipient of the message containing this option should consider the prefix valid for purposes of on-link determination (see description of the “L” flag just above). A value of all 1s means “infinity” (“forever”).												
Preferred Lifetime	4	Preferred Lifetime: When the recipient of this prefix uses it to automatically generate addresses using address autoconfiguration, specifies the amount of time, in seconds, that such addresses remain “preferred” (meaning, valid and freely usable). A value of all 1s means “infinity” (“forever”).												

Table 118: ICMPv6 *Prefix Information Option Format (Page 2 of 2)*

Field Name	Size (bytes)	Description
<i>Reserved</i>	4	Reserved: 4 unused bytes sent as zeroes.
<i>Prefix</i>	16	Prefix: The prefix being communicated from the router to the host in the <i>Router Advertisement</i> message. The <i>Prefix Length</i> field indicates how many of the 128 bits in this field are significant (part of the network ID). Only these bits are placed in the <i>Prefix</i> field, the remaining bits are cleared to zero.

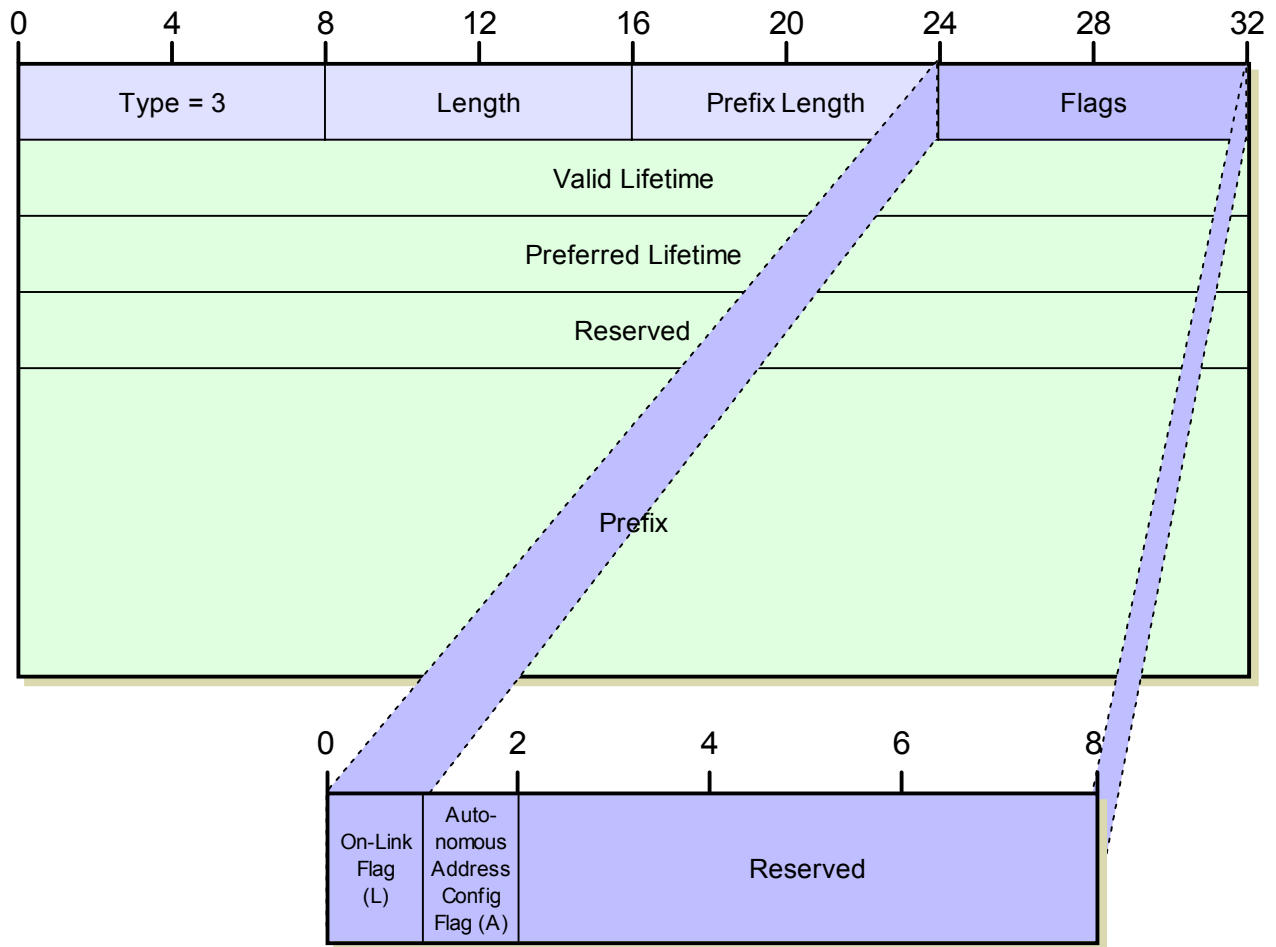

Figure 166: ICMPv6 *Prefix Information Option Format*

Redirected Header Option Format

In a *Redirect* message, provides a copy of the original message (or a portion of it) that led to the *Redirect* being generated. This option can be found in [Table 119](#) and [Figure 167](#).

Table 119: ICMPv6 Redirected Header Option Format

Field Name	Size (bytes)	Description
Type	1	Type: Identifies the ICMPv6 option type. For the <i>Redirected Header</i> option, the value is 4.
Length	1	Length: The length of the entire option (including the <i>Type</i> and <i>Length</i> fields), expressed in units of 8 octets (64 bits).
Reserved	6	Reserved: 6 reserved bytes sent as zeroes.
IP Header + Data	Variable	IP Header + Data: As much of the original IPv6 datagram as will fit without causing the size of the ICMPv6 error message (including its own IP header) to exceed the minimum IPv6 maximum transmission unit (MTU) of 1280 bytes.

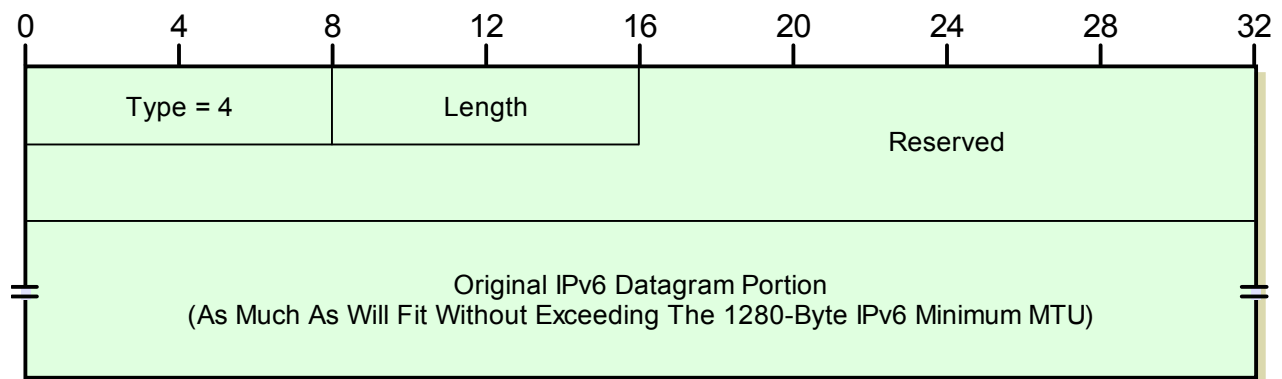

Figure 167: ICMPv6 Redirected Header Option Format

MTU Option Format

The *MTU* option lets a router convey a recommended [MTU value](#) in *Router Advertisement* messages. Its format is described in [Table 120](#) and [Figure 168](#).

Table 120: ICMPv6 MTU Option Format (Page 1 of 2)

Field Name	Size (bytes)	Description
Type	1	Type: Identifies the ICMPv6 option type. For the <i>MTU</i> option, the value is 5.
Length	1	Length: The length of the entire option (including the <i>Type</i> and <i>Length</i> fields), expressed in units of 8 octets (64 bits). The <i>MTU</i> option is fixed in length at 8 bytes so the value of this field is 1.

Table 120: ICMPv6 *MTU* Option Format (Page 2 of 2)

Field Name	Size (bytes)	Description
<i>Reserved</i>	2	Reserved: 2 reserved bytes sent as zeroes.
<i>MTU</i>	4	MTU: The maximum transmission unit (MTU) value , in bytes, that the router is recommending for use on the local link.

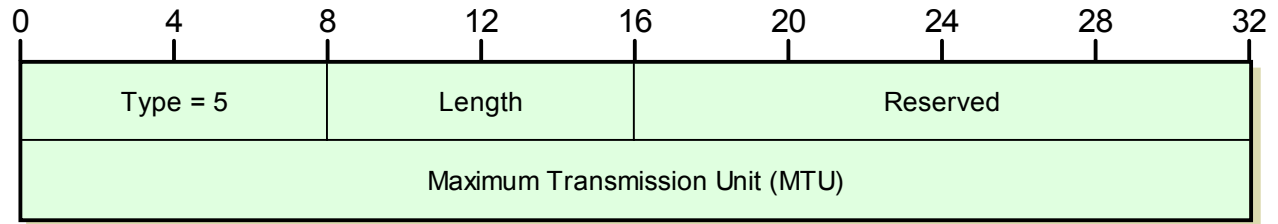

Figure 168: ICMPv6 *MTU* Option Format



TCP/IP IPv6 Neighbor Discovery Protocol (ND)

The new [Internet Protocol version 6 \(IPv6\)](#) represents an evolution of the venerable Internet Protocol. It maintains the same basic operational principles of IPv4, but makes some important modifications, particularly in the area of addressing. In fact, some of the more significant changes in IPv6 are actually not in the IP protocol itself, but in the protocols that support IP. One of the most interesting of these was the creation of an entirely new support protocol for IPv6. It combines several tasks previously performed by other protocols in IPv4, adds some new functions, and makes numerous improvements to the whole package. This new standard is called the IPv6 *Neighbor Discovery (ND)* protocol.

In this section I describe the new Neighbor Discovery protocol used in IPv6. I begin with an overview of the protocol, discussing its history, the motivation for its creation and the standards that define it. I then describe its operation in general terms, listing the fundamental functions that ND performs, the three groups these functions fit into, and the ICMPv6 message types used to carry them out. I describe the key differences between ND and the way that its functions were carried out in IPv4. I then provide more information on the three functional groups in ND: those that involve discovery of important internetwork information from routers, those that are related to address resolution and neighbor communication between hosts, and finally, router redirection.



Background Information: This section assumes basic comprehension of [IP version 6](#), which in turn requires understanding [IPv4](#). ND uses ICMP version 6 (ICMPv6) messages, so reference is made to [the ICMP section](#). Finally, since ICMP performs some functions done by the Address Resolution Protocol (ARP) in IPv4, you may need to refer to [the ARP discussion](#) if unfamiliar with its operation.

IPv6 ND Overview. History. Motivation and Standards

[The purpose of network layer protocols like the Internet Protocol](#) is to provide a means of connecting together individual local networks to create a much larger internetwork. To higher protocol layers and to users, this internetwork behaves in most respects as if it were a single large network, because the lower layers hide the details that “glue” together the individual networks. Any device can send information to any other, regardless of where it is located, and “like magic”, it will work. At least, most of the time.

The existence of an internetwork means that devices can treat all other devices as peers, at least from the perspective of higher protocol layers and applications. From the standpoint of lower layers, however, there is a very important difference between devices that are on a host's local network and those that are elsewhere. In a general sense, most devices have a more important relationship with the devices that are on its local network than those that are far away. Some of the most obvious tasks that a device must perform specifically with other devices on its local network include:

-
- ☉ **Direct Datagram Delivery:** Devices deliver data directly to other devices on their local network, while data going to distant devices must be *indirectly* delivered (routed).
 - ☉ **Layer Two Addressing:** To facilitate direct delivery, devices need to know the layer two addresses of the other devices on the local network; they don't need to know them for non-local devices.
 - ☉ **Router Identification:** To deliver indirectly, a device needs to find a router on its local network that it can talk to.
 - ☉ **Router Communication:** The local router must communicate information to each of the local hosts using it so they know how best to use it.
 - ☉ **Configuration:** Hosts will usually look to information provided by local devices to let them perform configuration tasks such as determining their own IP address.

To support these and other requirements, several special protocols and functions were developed along with the original Internet Protocol (version 4). The IP addressing scheme lets devices differentiate local addresses from distant ones. The [Address Resolution Protocol \(ARP\)](#) lets devices determine layer two addresses from layer three addresses. The [Internet Control Message Protocol \(ICMP\)](#) provides a messaging system to support various communication requirements between local devices, including the ability of a host to find a local router and the router to provide information to local hosts.

These features all work properly in IPv4, but they were developed sort of in an ad hoc manner. They are defined not in a single place, but rather in a variety of different Internet standards. There were also some limitations with the way these “local device” functions were implemented.

Formalizing Local Network Functions: The Concept of Neighbors

IP version 6 represents the biggest change in decades to not just the Internet Protocol itself, but the entire TCP/IP suite. It thus provided an ideal opportunity to formalize and integrate the many disparate functions and tasks related to communication between local devices. The result was the creation of a new protocol: *Neighbor Discovery for IP Version 6*, also commonly called the *IPv6 Neighbor Discovery* protocol. Since this protocol is new in version 6, there is no IPv4 version of it, so the name is usually just seen as the *Neighbor Discovery (ND)* protocol with no further qualifications; its use with IPv6 is implied.

The term *neighbor* is one that has been used for years in various networking standards and technologies to refer to devices that are local to each other. In the context of our current discussion, two devices are *neighbors* if they are on the same local network, meaning that they can send information to each other directly; the term can refer to either a regular host or a router. I think this is a good analogy to the way humans refer to those who live or work nearby. Just as most of us have a special relationship with people who are our neighbors and communicate more with them than with those who are far away, so do IP devices.

Since a neighbor is a local device, the name of the Neighbor Discovery protocol would seem to indicate that ND is all about how neighbors discover each other's existence. In the context of this protocol, however, the term *discovery* has a much more generic meaning: it refers to discovering not just who our neighbors are but also important information about

them. In addition to letting devices identify their neighbors, ND facilitates all the tasks in the bullet list above, including such functions as address resolution, parameter communication, autoconfiguration and much more as we will see in the next few topics.

Neighbor Discovery Standards

The Neighbor Discovery protocol was originally defined in RFC 1970, published in August 1996, and revised in the current defining standard, RFC 2461, published December 1998. Most of the functions of the ND protocol are implemented using a set of five [special ICMPv6 control messages](#). Thus, to some extent, the operation of ND is partially described by the ICMPv6 standard, RFC 2463. Where ICMPv4 can be considered IPv4's "administrative assistant", IPv6 really has two such assistants working closely together: ICMPv6 and the IPv6 ND protocol. I discuss more of the differences between the ways IPv4 and IPv6 implement ND's functions later in this section.



Key Concept: The new *IPv6 Neighbor Discovery* protocol formalizes for IPv6 a number of functions related to communication between devices on a local network that are performed in IPv4 by protocols such as ARP and ICMP. ND is considered another "helper" protocol for IPv6, and is closely related to ICMPv6.

IPv6 ND General Operational Overview: ND Functions, Functional Groups and Message Types

As I mentioned in [the preceding overview](#), the name of the Neighbor Discovery (ND) protocol really does not do it justice. The protocol facilitates not merely the discovery of neighboring devices, but a substantial number of functions related to local network connectivity, datagram routing and configuration. Both regular hosts and routers in an IPv6 environment count on the ND protocol to facilitate important exchanges of information that are necessary for proper internetwork operation.

The Neighbor Discovery protocol has a number of similarities to the [Internet Control Message Protocol](#). An important one is that like ICMP, ND is a **messaging** protocol. It doesn't implement a single specific function but rather a group of activities that are performed through the exchange of messages. This means we can't explain the operation of ND through a specific description of "what ND does", but rather must define its operation by means of a list of messages ND provides and specific ways that they are used.

Any local network on an internet will have both regular hosts and routers, and the term *neighbor* can refer to either. Of course, hosts and routers play different roles on a network, and as a result *neighbor discovery* is very different for each. The ND standard describes nine specific functions performed by the protocol. To better understand these functions and how they are related, we can divide them into three functional groups based on communication type and the kinds of devices involved (see [Figure 169](#)).

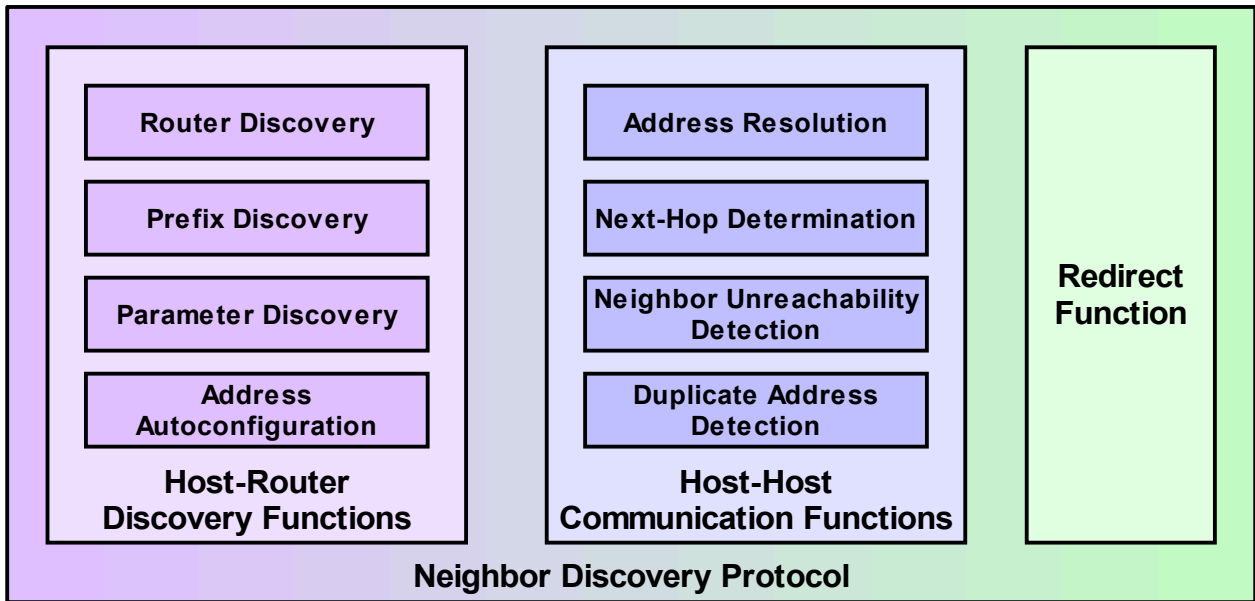

Figure 169: Neighbor Discovery Protocol (ND) Functional Groups and Functions

Host-Router Discovery Functions

One of the two main groups of functions in ND are those that facilitate the discovery of local routers and the exchange of information between them and hosts. This includes four specific functions:

- ☉ **Router Discovery:** This is the core function of this group: the method by which hosts locate routers on their local network.
- ☉ **Prefix Discovery:** Closely related to the process of router discovery is prefix discovery. Recall that [the term “prefix” refers to the network portion of an IP address](#). Hosts use this function to determine what network they are on, which in turn tells them how to differentiate between local and distant destinations and whether to attempt direct or indirect delivery of datagrams.
- ☉ **Parameter Discovery:** Also closely related to router discovery, this is the method by which a host learns important parameters about the local network and/or routers, such as the [maximum transmission unit](#) of the local link.
- ☉ **Address Autoconfiguration:** Hosts in IPv6 are designed to be able to [automatically configure themselves](#), but this requires information that is normally provided by a router.

Host-Host Communication Functions

The other main group of functions is that associated with information determination and communication directly between nodes, usually hosts. Some of these functions can be performed between hosts and routers, but this group is not specifically related to router discovery; it includes:

-
- 🕒 **Address Resolution:** The process by which a device determines the layer two address of another device on the local network from that device's layer three (IP) address. This is the job performed by [ARP](#) in IP version 4.
 - 🕒 **Next-Hop Determination:** The method for looking at an IP datagram's destination address and determining where it should next be sent.
 - 🕒 **Neighbor Unreachability Detection:** The process of determining whether or not a neighbor device can be directly contacted.
 - 🕒 **Duplicate Address Detection:** Determining if an address that a device wishes to use already exists on the network.

Redirect Function

The last functional group contains just one function: *Redirect*. The technique whereby a router informs a host of a better next-hop node to use for a particular destination.



Key Concept: The *Neighbor Discovery* protocol encompasses nine individual functions, many of which are related to each other. They are organized into three functional groups: host-router discovery functions, host-host communication functions, and the redirect function.

Relationships Between Functions

The division of ND's overall functionality into nine tasks in three groups is somewhat arbitrary, but provides a good frame of reference for understanding what the protocol does. Obviously some of the functions in different groups are related; next-hop determination uses information obtained as part of parameter discovery. The redirect function is also a form of router-host communication but is distinct from router discovery.

ICMPv6 Messages Used By the Neighbor Discovery Protocol

Just as ND is similar to ICMP in its operation, the two protocols are related in another way: the method that messaging is done. ND actually implements its functions using ICMPv6 messages. A set of five message types is described in the ND standard:

- 🕒 **Router Advertisement Messages:** Sent regularly by routers to tell hosts that they exist and provide important prefix and parameter information to them.
- 🕒 **Router Solicitation Messages:** Sent by hosts to request that any local routers send a *Router Advertisement* message so they don't have to wait for the next regular advertisement message.
- 🕒 **Neighbor Advertisement Messages:** Sent by hosts to indicate the existence of the host and provide information about it.
- 🕒 **Neighbor Solicitation Messages:** Sent to verify the existence of another host and to ask it to transmit a *Neighbor Advertisement*.

-
- ☉ **Redirect Messages:** Sent by a router to tell a host of a better method to route data to a particular destination.

More details on how these message types are used can be found in the topics later in this section that describe the three functional groups above in more detail. The structures of each of the five ICMPv6 message types used by ND can be found in the section on [ICMPv6 informational message types and formats](#).

IPv6 ND Functions Compared to Equivalent IPv4 Functions

The IPv6 Neighbor Discovery protocol has the distinction of being the only truly *new* protocol created as part of the core of [Internet Protocol version 6](#); there is no “NDv4” at all. Of course, most of the services that ND provides to IPv6 were also required in version 4 of the Internet Protocol. They were just provided in a rather diverse set of protocols and standards that the ND protocol has formalized, integrated and improved.

What this means is that while ND is new, the jobs it does are equivalent to the tasks performed by several other protocols in IPv4. Specifically, the bulk of ND functions correspond to the following set of standards, features and message types in IPv4:

- ☉ **ICMPv4 Router Discovery:** Most of the functions associated with identifying and obtaining information from routers in ND are based on the use of ICMPv4 *Router Advertisement* and *Router Solicitation* messages as defined in RFC 1256.
- ☉ **Address Resolution Protocol:** ND provides enhanced address resolution capabilities that are similar to the functions provided in IPv4 by [ARP](#).
- ☉ **ICMPv4 Redirect:** ND's redirect function and *Redirect* messages are based on similar functionality defined in IPv4 and ICMPv4.

Of course, there are other aspects of ND that only somewhat correlate to how things work in IPv4. There are also improvements or new functionality compared to how these IPv4 functions work. Some of these are in fact due to differences in how IPv6 itself operates compared to IPv4. For example, prefix discovery in ND is sort of related to the *Address Mask Request* and *Address Mask Reply* messaging in ICMPv4.

Overall, ND represents a substantial improvement compared to the way its job was done in IP version 4. Like IPv6 itself, ND is generally better suited to the needs of modern networks than the older protocols. Some of the more important specific improvements made in ND compared to how its job was done in IPv4 include the following:

- ☉ **Formalizing Of Router Discovery:** In IPv4 the process of router discovery and solicitation was arguably an “afterthought”; ND formalizes this process and makes it part of the core of the TCP/IP protocol suite.
- ☉ **Formalizing Of Address Resolution:** In a similar manner, address resolution is handled in a superior way in ND. ND functions at layer three and is tightly tied to IP just like ICMP is. There is no more need for an “ambiguously-layered” protocol like ARP, whose implementation is very dependent on the underlying physical and data link layers.

-
- ④ **Ability To Perform Functions Securely:** ND operates at the network layer, so it can make use of the authentication and encryption capabilities of [IPSec](#) for tasks such as address resolution or router discovery.
 - ④ **Autoconfiguration:** In combination with features built into IPv6, ND allows many devices to automatically configure themselves even without the need for something like a DHCP server (though [DHCPv6](#) does also exist.)
 - ④ **Dynamic Router Selection:** Devices use ND to detect if neighbors are reachable or not. If a device is using a router that stops being reachable it will detect this and automatically switch to another one.
 - ④ **Multicast-Based Address Resolution:** Address resolution is performed using special [multicast addresses](#) instead of broadcasts, reducing unnecessary disruption of “innocent bystanders” when resolution messages must be sent.
 - ④ **Better Redirection:** Improvements have been made to the method by which redirects are generated and used.

IPv6 ND Host-Router Discovery Functions: Router Discovery, Prefix Discovery, Parameter Discovery and Address Autoconfiguration

Internetworks are created by connecting together individual networks. The devices that are responsible for this connection of networks are routers, which send data from one network to the next. A host must rely on a router to forward transmissions to all devices other than those on the local network. For this reason, before a host can properly use an internetwork, it needs to find a local router and learn important information about both the router and the network itself. Enabling this information exchange is one of the most important jobs of the IPv6 Neighbor Discovery protocol.

The general term used to describe most of the ND communication between hosts and routers on a local network is *discovery*. [As we discussed earlier in this section](#), the term encompasses not merely discovery of the router but also communication of important parameters. Most of this communication flows from the routers to the hosts, since routers really control the way that each network is used. They provide information to hosts so the hosts know how best to operate.

The various discovery features related to host-router communication are all facilitated by the same exchange of two different ICMPv6 message types. *Router Advertisement* messages are sent only by routers, and contain information about the router and also the network on which it is located. *Router Solicitation* messages are optional, and sent by hosts when they want to find a local router. The format of each of these messages is described in [the section on ICMPv6 informational messages](#).

Host-Router Discovery Functions Performed By Routers

The mechanisms for using these messages is not really that complicated. The best way to see how the discovery process works overall is to look at the specific tasks performed both by routers and hosts in ND. Let's start with those performed by routers:

-
- ④ **Routine Advertisement:** The main job that routers do in ND is the regular transmission of *Router Advertisement* messages. Each router maintains a timer that controls how often an advertisement is sent out. Advertisements are also sent when any sort of special situation arises. For example, a message will be sent if key information about the router changes, such as its address on the local network.

Router Advertisement messages include key information about both the router and the network. [See the relevant topic in the ICMPv6 section for a full description of the Router Advertisement message format.](#)

- ④ **Parameter Maintenance:** Routers are responsible for maintaining key parameters about the local network so they can be sent in advertisements. These include the default *Hop Limit* that should be used by hosts on the network, a default **MTU** value for the network, and information such as network prefixes that are used for both first-hop routing by hosts and autoconfiguration.

Again, some more details on these can be found in [the topic that discusses Router Advertisement fields.](#)

- ④ **Solicitation Processing:** Routers listen for *Router Solicitation* messages and when one is received, will immediately send a *Router Advertisement* to the requesting host.

Host-Router Discovery Functions Performed By Hosts

For their part, hosts are responsible for three main functions.

- ④ **Advertisement Processing:** Hosts listen for advertisements on their local network and process them. They then set appropriate parameters based on the information in these messages. This includes maintaining various data structures such as lists of prefixes and routers, which are updated regularly as new advertisement information comes in.
- ④ **Solicitation Generation:** Under certain conditions a host will generate a *Router Solicitation* and send it out on the local network. This very simple message just requests that any local routers that hear it immediately send a *Router Advertisement* message back to the device that made the request. This is most often done when a host is first turned on, so it doesn't have to sit "in limbo" waiting for the next routine advertisement.
- ④ **Autoconfiguration:** When required, and if the network supports the function, the host will use information from the local router to allow it to [automatically configure itself](#) with an IP address and other parameters.



Key Concept: One of the two main functional groups of the Neighbor Discovery protocol is the set of host-router discovery functions. They allow hosts on a local network to discover the identity of a local router and learn important parameters about how the network is to be used. Host-router discovery operations are performed using ICMPv6 *Router Advertisement* and *Router Solicitation* messages.



Note: Both *Router Advertisement* and *Router Solicitation* messages may include an optional layer two address of the device sending the message. This is used to update address resolution caches to save time when address resolution is needed later on.

IPv6 ND Host-Host Communication Functions: Address Resolution, Next-Hop Determination, Neighbor Unreachability Detection and Duplicate Address Detection

The delivery of datagrams in IP can be divided into two methods: *direct* and *indirect*. Indirect datagram delivery requires that routers provide help to hosts, which leads to the host-router discovery functions we examined in [the previous topic](#). Direct delivery of datagrams is performed from one host to another on the same network. This doesn't require the use of routers, but necessitates other IPv6 ND protocol functions that involve Next-Hop Determination communication directly between local hosts.

Next-Hop Determination

The first task that any host must perform when it wants to send a datagram is *Next-Hop Determination*. This is the process by which a device looks at the destination address in a datagram and decides whether direct or indirect delivery are required. In early IPv4 this was done [by looking at the class of the address, and later on, by using the subnet mask](#). In IPv6, the prefix information obtained from local routers is compared to the destination of the datagram to determine if the destination device is local or distant. If it is local, the next hop is the same as the destination address; if it is non-local, the next hop is chosen from the device's list of local routers (which are determined either by manual configuration or using the host-router discovery features of ND.)

For efficiency purposes, hosts do not perform this next-hop determination for each and every datagram. They maintain a *destination cache* that contains information about what the next hop should be for recent devices to which datagrams have been sent. Each time a next hop determination is performed for a particular destination, information from that determination is entered into the cache, so it can be used the next time datagrams are sent to that device.

Address Resolution

If a host determines that the destination of a datagram is in fact local, it will then need to send the datagram to that device. The actual transmission will occur using whatever physical layer and data link layer technology has been used to implement the local network. This requires that we know the layer two address of the destination, even though we only generally have the layer three address from the datagram. Getting from the layer three address to the layer two address is known as [the address resolution problem](#).

In IPv6, the ND protocol is responsible for address resolution. When a host wants to get the layer two address of a datagram destination it sends a *Neighbor Solicitation* ICMPv6 message containing the IP address of the device whose layer two address it wishes to determine. That device responds back with a *Neighbor Advertisement* message that contains its layer two address. Instead of using a broadcast that would disrupt each device on the local network, the solicitation is sent using a special multicast to the destination device's *solicited-node address*. [A more complete description of address resolution in IPv6 can be found in the general section on address resolution.](#)

Note also that even though this discussion does concentrate on communication between hosts, address resolution may also be done when a host needs to send a datagram to a local router and has no entry for it in its destination cache. In the context of address resolution, a destination device is “just a neighbor”. Whether it is a host or a router only matters in terms of what happens after the datagram has been sent and received. In other words, these “host-to-host” functions are so named only because they are not specific to the communication between hosts and routers like the tasks in the preceding topic.

Updating Neighbors Using Neighbor Advertisement Messages

Devices do not routinely send *Neighbor Advertisements* the way routers send *Router Advertisements*. There really isn't any need for this: neighbors don't change much over time, and resolution will occur naturally over time as devices send datagrams to each other. In addition, having advertisements sent regularly by so many devices on a network would be wasteful.

A host may, however, send an unsolicited *Neighbor Advertisement* under certain conditions where it feels it is necessary to immediately provide updated information to other neighbors on the local network. A good example of this is a hardware failure—in particular, the failure of a network interface card. When the card is replaced, the device's layer two (MAC) address will change. Assuming this can be detected by the device's IP layer, it can send out an unsolicited *Neighbor Advertisement* message to tell other devices to update their resolution caches with the new MAC address.

Neighbor Unreachability Detection and the Neighbor Cache

Neighbor Solicitation and *Neighbor Advertisement* messages are most often associated with address resolution, but also have other purposes. One of these is *Neighbor Unreachability Detection*. Each device maintains information about each of its neighbors and updates it dynamically as network conditions change. The information is kept for both host and router devices that are neighbors on the local network.

Knowing that a device has become unreachable is important because a host can adapt its behavior accordingly. In the case of an unreachable host, a device may wait a certain period of time before trying to send datagrams to an unreachable host instead of flooding the network with repeated attempts to send to the host. An unreachable router, on the other hand, is a signal that the device needs to find a new router to use, if an alternate is available.

Each host maintains a *neighbor cache* that contains information about neighboring devices. Each time a host receives a datagram from a neighbor, it knows the neighbor is reachable at that particular moment, so the device makes an entry in the cache for the neighbor to indicate this. Of course, receiving a datagram from a neighbor now only means the neighbor is reachable now; the more time that elapses since the last datagram was received, the greater the chance that something has happened to make the neighbor no longer reachable.

For this reason, neighbor reachability information must be considered temporary. Each time a neighbor is entered into the cache as reachable, a timer is started. When the timer expires, the reachability information for that neighbor is considered *stale*, and reachability is no longer assumed for that neighbor. When a new datagram is received from the neighbor in question the timer is reset and the cache is again set to indicate that the device is reachable. The amount of time a host should consider a neighbor reachable before expiring it is communicated by a local router using a field in a [Router Advertisement message](#).

A host can also dynamically seek out a neighbor if it needs to know its reachability status. It sends a *Neighbor Solicitation* to the device and waits for a *Neighbor Advertisement* in response. It then updates the cache accordingly.

Duplicate Address Detection

The last use of the two messages we have been discussing here is for *Duplicate Address Detection*. When a host uses the [IPv6 autoconfiguration facility](#), one of the steps in the process is to ensure that the address it is trying to use doesn't already exist on the network. This is done by sending a *Neighbor Solicitation* message to the address the device wishes to use. If a *Neighbor Advertisement* is received in reply the address is already in use.



Key Concept: The second of the two main functional groups of the Neighbor Discovery protocol is the set of host-host communication functions. Two ICMPv6 messages are defined, *Neighbor Advertisement* and *Neighbor Solicitation*, which enable a variety of types of essential communication between adjacent hosts on a local network. These include address resolution, determining the next hop to which a datagram should be sent, and also the assessment of a neighboring device's reachability.

IPv6 ND Redirect Function

The last of the major responsibilities of the IPv6 Neighbor Discovery protocol is the *redirect function*. This is used by a router to inform a host of a better route to use for datagrams sent to a particular destination. An argument could be made that the redirect function should be part of the host-router group since it represents a form of communication between routers and regular hosts. However, it is somewhat different from the other “discovery” functions and so the standard treats it separately.

Routers are responsible for detecting situations where a host on the local network has made an inefficient first-hop routing decision, and then attempting to correct it. For example, consider a network that has two routers on it, *R1* and *R2*. A host *H1* wants to send a datagram to device *X2* on another network that is connected to *H1*'s network through router *R2*. If *H1* sends the datagram to *R1*, *R1* will of course know it has to go through *R2* and will send it there. Seeing that *R2* was also on the local network, *R1* therefore knows that *H1* made a poor initial routing decision: the datagram should have been sent to *R2* directly, not *R1*. If this sounds very similar to ICMPv4 redirect feature, [that's because it is](#).

In response, *R1* will create a special *Redirect* ICMPv6 message. This message will tell *H1* that for any subsequent datagrams to be sent to *X2* should be first sent to *R2* instead of *R1*. It is also possible that a router may determine other situations where the first hop from a particular host should be different and will advise the host using a *Redirect* message. This is illustrated in [Figure 170](#).

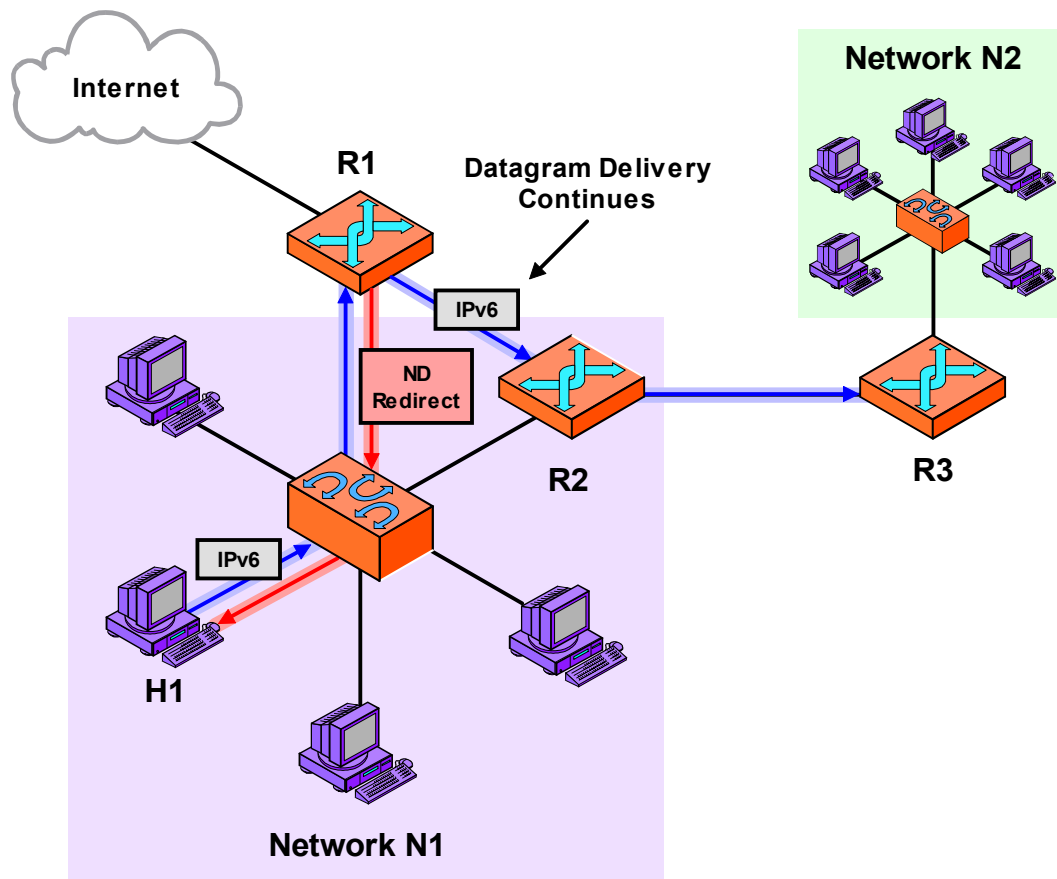

Figure 170: ND Host Redirection Using an ICMPv6 *Redirect* Message

H1 sends to *R1* an IPv6 datagram destined for a device on network *N2*. However, *R1* notices that *R2* is on the same network as the source device and is a more direct route to *N2*. It forwards the datagram on to *R2* but also sends an ICMPv6 *Redirect* message back to *H1* to tell it to use *R2* next time.

Only routers send *Redirect* messages, not hosts. Hosts are responsible for looking for these *Redirect* messages and processing them. A host receiving such a message will look in it to see which destination's datagram led to the redirect, and which new first hop the router is saying the host should use in the future for that destination. In this case, *H1* will see that *R1* is saying any further datagrams to *X2* should be sent to *R2* instead of *R1*. *H1* will update its destination cache for *X2* accordingly.



Key Concept: The Neighbor Discovery protocol redirect function allows a router to tell a host to use a different router for future transmissions to a particular destination. It is similar to the IPv4 redirect feature and is implemented using ICMPv6 *Redirect* messages.

When a router sends a *Redirect*, it may also include in the message the data link layer address of the destination to which it is redirecting. This address is used by the host to update its address resolution cache, if necessary. This may save bandwidth in the future by eliminating an address resolution cycle, when the redirected host tries to send to the new, redirected location. In our example, *R1* may include *R2*'s own layer two address in the redirect. This can be used by *H1* the next time it has a datagram for *X2*.

IPv6 also supports authentication of *Redirect* messages, to prevent unauthorized devices from causing havoc by sending inappropriate *Redirects*. A host may be configured to discard *Redirects* that are not properly authenticated.



TCP/IP Routing Protocols (Gateway Protocols)

Routing is not just one of the most important activities that takes place at the network layer: it is the function that really **defines** [layer three of the OSI Reference Model](#). Routing is what enables small local networks to be linked together to form potentially huge internetworks that can span cities, countries or even the entire globe. It is the job done by special devices called *routers*, which forward datagrams from network to network, allowing any device to send to any other even if the source has no idea where the destination is.

Routing is a complicated subject. The short summary of the process is that routers decide how to forward a datagram based on its destination address, which is compared to information the router keeps in special [routing tables](#). These tables contain entries for each of the networks the router knows about, telling the router which adjacent router the datagram should be sent to in order for it to reach its eventual destination.

As you can imagine, routing tables are critically important to the routing process. It is possible for these tables to be manually maintained by network administrators, but this is tedious, time-consuming and doesn't allow routers to deal with changes or problems in the internetwork. Instead, most modern routers are designed with functionality that lets them share route information with other routers, so they can keep their routing tables up to date automatically. This information exchange is accomplished through the use of *routing protocols*.

In this section I provide a description of the most common routing (or gateway) protocols used in TCP/IP. I begin with an overview of various concepts that are important to know in order to understand how routing protocols work. I then describe the TCP/IP routing protocols themselves in two subsections. The first covers interior routing protocols, which are used between routers in an autonomous system, and the second looks at exterior routing protocols, used between autonomous systems.

If you don't understand what an autonomous system is or the difference between an interior and exterior protocol, then you know why I included an overview topic on concepts first. In fact, it is really much easier to understand routing protocols once you have a good background on the entire process of routing.

You may notice that in the title of this section I refer to both *routing protocols* and *gateway protocols*. These terms are interchangeable, and in fact, the word *gateway* appears in the name of several of the protocols. This is an artifact of the historical use of the term *gateway* in early TCP/IP standards to refer to the devices we now call routers. Today, the term *gateway* normally refers not to a router, but to a different type of network interconnection device, so this can be particularly confusing. The term "routing protocol" is now preferred, and is the one I use.



Note: Some of the protocols in this section are generic enough that they could be applied to support the routing of any network layer protocol. They are most often associated with IP, however, as TCP/IP is by far the most popular internetworking protocol suite, and that is my assumption in describing them. Also, this section focuses primarily on the routing protocols used in Internet Protocol version 4. There is limited discussion of IPv6 versions of the protocols at this time.



Note: Strictly speaking, an argument could be made that some routing protocols don't belong in layer three. For example, many of them send messages using TCP or UDP at layer four. Despite this, routing is inherently a layer three activity and for this reason, it is traditional to consider routing protocols part of layer three.



Note: Like all topics related to routing, routing protocols are generally quite complex. I cover the major ones here in more detail than most general networking references, but even so, you should recognize that I am only scratching the surface, especially of the more complicated ones like OSPF. You can check out the referenced Internet standards (RFCs) for more details if you desire. I should also point out that there are still more routing protocols in use on IP networks that I do not cover here, such as IS-IS (which is actually an OSI protocol and not formally part of TCP/IP).

Overview Of Key Routing Protocol Concepts: Architectures, Protocol Types, Algorithms and Metrics

Routing protocols play an important part in the overall process of routing in an internetwork. It is therefore easiest to understand them in the scope of an overall discussion of routing. It's difficult to describe the individual TCP/IP routing protocols without some background information on how routing protocols work. For this reason, I feel it is worth taking a brief look at key routing protocol concepts here, so that you will have more luck making sense of the rest of the routing protocol topics in this section.

Routing Protocol Architectures

Let's start with a look at routing protocol architectures. In this context, the word *architecture* refers to the way that an internetwork is structured. Once we have a number of networks and routers we wish to connect together, there are any number of ways that we can do this. The architecture we choose is based on the way that routers are linked up, and this has an impact on the way that routing is done, and how routing protocols operate.

Core Architecture

TCP/IP and the Internet were developed simultaneously, so TCP/IP routing protocols evolved as the Internet itself did. Early architecture of the Internet consisted of a small number of *core* routers that contained comprehensive information about the internetwork. When the Internet was very small, it was expanded by adding more routers to this core. However, each time the core was expanded, the amount of routing information that needed to be maintained grew.

Eventually, the core became too large, so a two-level hierarchy was formed to allow further expansion. *Non-core* routers were located on the periphery of the core and contained only partial routing information; they relied on the core routers for transmissions that went across the internetwork. A special routing protocol called the *Gateway-to-Gateway Protocol (GGP)* was used within the core of the internetwork, while another protocol called the *Exterior Gateway Protocol (EGP)* was used between non-core and core routers. The non-core routers were sometimes single, stand-alone routers that connected a single network to the core, or they could be sets of routers for an organization.

This architecture served for a while, but itself did not **scale** very well as the Internet grew. The problem was mainly due to the fact that there was only a single level to the architecture: every router in the core had to communicate with every other. Even with peripheral routers being kept outside the core, the amount of traffic in the core kept growing.

Autonomous System (AS) Architecture

To resolve the limitations of the early core system, a new architecture was created that moved away from the centralized concept of a core towards an architecture that was better suited to a larger and growing internetwork. This decentralized architecture treats the

Internet as a set of independent groups, which each group called an *autonomous system* (AS). An AS consists of a set of routers and networks controlled by a particular organization or administrative entity, which uses a single consistent policy for internal routing.

The power of this system is that routing on the internetwork as a whole occurs between ASes and not individual routers. Information is only shared between one or maybe a couple of routers in each AS, not every router in each AS. The details of routing within an AS are also hidden from the rest of the internetwork. This provides both flexibility for each AS to do routing as it sees fit (thus the name *autonomous*) and efficiency for the overall internetwork. Each AS has its own number, and the numbers are globally managed to make sure they are unique across an internetwork (such as the Internet).



Key Concept: Large, modern TCP/IP internetworks can contain thousands of routers. To better manage routing in such an environment, routers are grouped into constructs called *autonomous systems*. Each autonomous system (AS) consists of a group of routers managed independently by a particular organization or entity.

Modern Protocol Types: Interior and Exterior Routing Protocols

The different nature of routing within an AS and between ASes can be seen in the fact that distinct sets of TCP/IP routing protocols are used for each type:

- ☉ **Interior Routing Protocols:** These protocols are used to exchange routing information between routers within an autonomous system. Interior routing protocols are not used between ASes.
- ☉ **Exterior Routing Protocols:** These protocols are used to exchange routing information between autonomous systems. They may in some cases be used between routers within an AS, but primarily deal with exchanging information between autonomous systems.



Key Concept: Interior routing protocols are used to share routing information within an autonomous system; each AS may use a different interior routing protocol because the system is, as the name says, autonomous. Exterior routing protocols convey routing data between autonomous systems; each AS must use the same exterior protocol to ensure that they can communicate.

Since autonomous systems are just sets of routers, this means that ASes are connected by linking a router in one AS to a router in another AS. Architecturally, an AS consists of a set of routers with two different types of connectivity:

- ☉ **Internal Routers:** Some routers in an AS connect only to other routers in the same AS. These run interior routing protocols.

- **Border Routers:** Some routers in an AS connect both to routers within the AS and to routers in one or more other ASes. These devices are responsible for passing traffic between the AS and the rest of the internetwork. They run both interior and exterior routing protocols.

Due to its advantages, the autonomous system architecture, an example of which can be seen in [Figure 171](#), has become the standard for TCP/IP networks, most notably the Internet. The division of routing protocols into the interior and exterior classifications has thus also become standard, and all modern TCP/IP routing protocols are first subdivided by type in this manner. You can see this reflected in the subsection titles in the rest of this section on routing protocols.

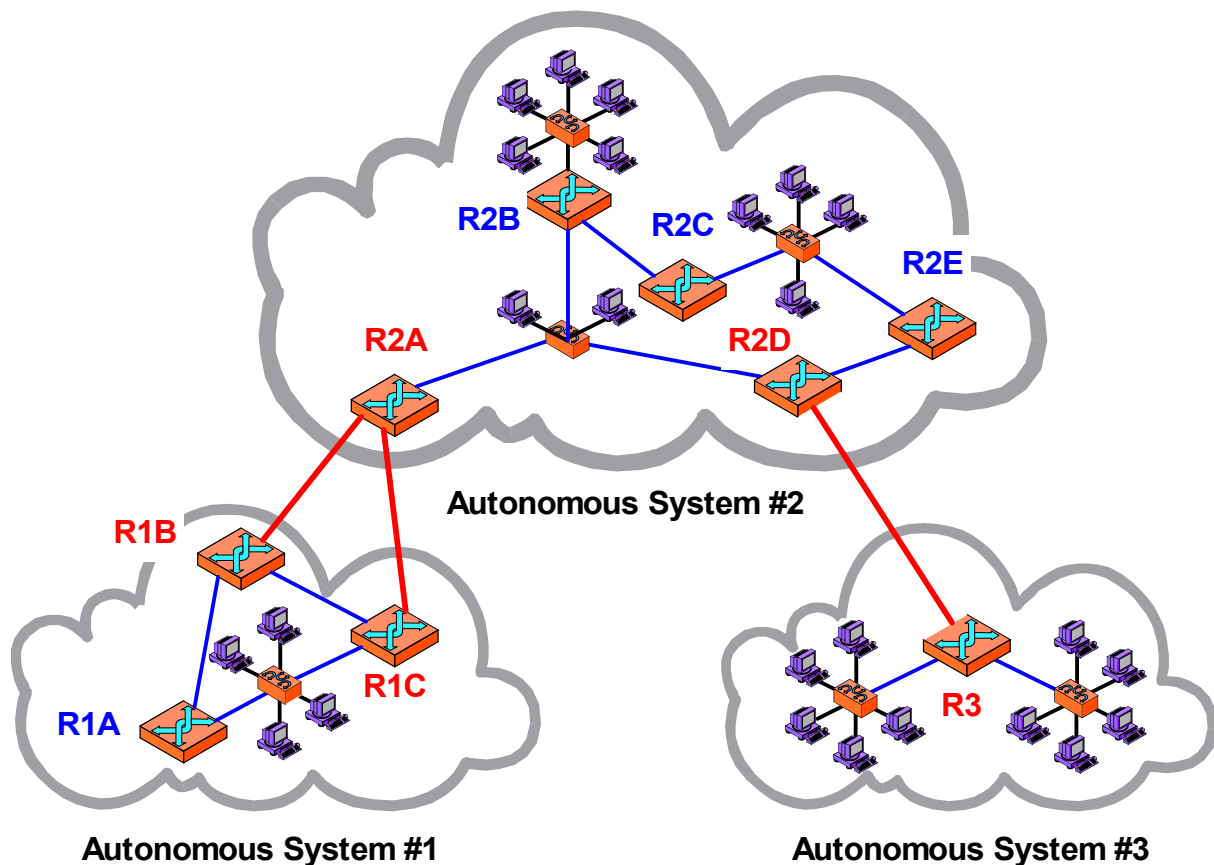

Figure 171: TCP/IP Autonomous System (AS) Routing Architecture

This diagram shows a simplified internet organized into three autonomous systems (ASes), each of which is managed independently of the others. Communication within each AS is done using an interior routing protocol chosen by that AS's administrators (blue links); communication between ASes must be done using a common exterior routing protocol (red links). Internal routers are shown in blue and border routers in red.

Routing Protocol Algorithms and Metrics

Another key differentiation of routing protocols is on the basis of the *algorithms* and *metrics* they use. An algorithm refers to a method that the protocol uses for determining the best route between any pair of networks, and for sharing routing information between routers. A

metric is a measure of “cost” that is used to assess the efficiency of a particular route. Since internetworks can be quite complex, the algorithms and metrics of a protocol are very important, and can be the determining factor in deciding that one protocol is superior to another.

There are two routing protocol algorithms that are most commonly encountered: distance-vector and link-state. There are also protocols that use a combination of these methods, or others.

Distance-Vector (Bellman-Ford) Routing Protocol Algorithm

A *distance vector* routing algorithm, also called a *Bellman-Ford* algorithm after two of its inventors, is one where routes are selected based on the distance between networks. The distance metric is something simple—usually the number of “hops”, or routers between them.

Routers using this type of protocol maintain information about the distance to all known networks in a table. They regularly send that table to each router they immediately connect with (their *neighbors* or *peers*). These routers then update their tables and send to their neighbors. This causes distance information to propagate across the internetwork, so that eventually each router obtains distance information about all networks on the internet.

Distance-vector routing protocols are somewhat limited in their ability to choose the best route. They also are subject to certain problems in their operation that must be worked around through the addition of special heuristics and features. Their chief advantages are simplicity and history (they have been used for a long time).

Link-State (Shortest Path First) Routing Protocol Algorithm:

A *link-state* algorithm selects routes based on a dynamic assessment of the shortest path between any two networks, and is for that reason also called a *shortest-path first* method. Each router maintains a map describing the current topology of the internetwork. This map is updated regularly by testing reachability of different parts of the internet, and by exchanging link-state information with other routers. The determination of the best route (“shortest path”) can be made based on a variety of metrics that indicate the true cost of sending a datagram over a particular route.

Link-state algorithms are much more powerful than distance-vector algorithms. They adapt dynamically to changing internetwork conditions, and also allow routes to be selected based on more realistic metrics of cost than simply the number of hops between networks. However, they are more complicated to set up and use more computer processing resources than distance-vector algorithms, and aren't as well-established.

Hybrid Routing Protocol Algorithms

There are also hybrid protocols that combine features from both types of algorithms, and other protocols that use completely different algorithms. For example, the [Border Gateway Protocol \(BGP\)](#) is a *path-vector* algorithm, which is somewhat similar to the distance-vector

algorithm, but communicates much more detailed route information. It includes some of the attributes of distance-vector and link-state protocols, but is more than just a combination of the two.

Static and Dynamic Routing Protocols

You may also occasionally see routing protocols categorized by type as *static* and *dynamic*, so this is the last concept I want to discuss in this overview. This terminology is somewhat misleading. The term “static routing” simply refers to a situation where the routing tables are manually set up, so they remain static. In contrast, “dynamic routing” is the subject of this entire section: the use of routing protocols to dynamically update routing tables. Thus, ***all*** routing protocols are “dynamic”. There is no such thing as a “static routing protocol” unless you consider a network administrator editing a routing table a “protocol”.



TCP/IP Interior Routing Protocols (RIP, OSPF, GGP, HELLO, IGRP, EIGRP)

Modern TCP/IP routing architecture groups routers into *autonomous systems (ASes)* that are independently controlled by different organizations and companies. The routing protocols used to facilitate the exchange of routing information between routers within an AS are called *interior routing protocols* (or historically, *interior gateway protocols*). Since most network administrators are responsible for routers within a particular organization, these are the routing protocols you are most likely to deal with unless you become a major Internet big-shot. ☺

One of the benefits of autonomous systems architecture is that the details of what happens within an AS are hidden from the rest of the internetwork. This means that there is no need for universal agreement on a single “language” for an internet as is the case for exterior routing protocols. As a network administrator for an AS, you are free to choose whatever interior routing protocol best suits your networks. The result of this is that there is no agreement on the use of a single TCP/IP interior routing protocol. There are several common ones in use today, though as is usually the case, some are more popular than others.

In this section I provide a description of six different protocols used for routing within autonomous systems in TCP/IP. The first two sections provide comprehensive descriptions of two of the most popular TCP/IP interior routing protocols: the Routing Information Protocol (RIP) and Open Shortest Path First (OSPF). The third section provides a more brief discussion of two historical interior routing protocols and two proprietary ones developed by networking leader Cisco Systems.

TCP/IP Routing Information Protocol (RIP, RIP-2 and RIPng)

The most popular of the TCP/IP interior routing protocols is the *Routing Information Protocol (RIP)*. The simplicity of the name matches the simplicity of the protocol—RIP is one of the easiest to configure and least resource-demanding of all the routing protocols. Its popularity is due both to this simplicity and its long history. In fact, support for RIP has been built into operating systems for as long as TCP/IP itself has existed.

In this section I describe the characteristics and operation of the TCP/IP Routing Information Protocol (RIP). There are three versions of RIP: RIP versions 1 and 2 for IP version 4 and RIPng (*next generation*) for IP version 6. The basic operation of the protocol is mostly the same for all three versions, but there are also some notable differences between them, especially in terms of the format of messages sent.

For this reason, I have divided my description of RIP into two subsections. In the first, I describe the fundamental attributes of RIP and its operation in general terms for all three versions. In the second, I take a closer look at each version, showing the message format used for each and discussing version-specific features as well.

RIP Fundamentals and General Operation

The *Routing Information Protocol (RIP)* was one of the first interior routing protocols used in TCP/IP. Over 20 years later, it continues to be widely used. Even though RIP has important limitations that have caused some to malign it and in fact led to the development of newer routing protocols that are technically superior to it, RIP continues to have an important place in TCP/IP routing to this day. Evidence that RIP has a future can be seen in the creation of an IPv6 version of the protocol: *RIPng*.

In this section, I provide an overall description of the characteristics of RIP and how it works in general terms. I begin with an overview and history of the protocol, including a brief discussion of its different versions and the standards that define them. I describe the method that RIP uses to determine routes and the metric used to assess route cost. I describe the general operation of the protocol including message types and when they are sent. I then describe the most important limitations and issues with RIP, and the special features that have been added to the protocol to resolve several problems with the basic RIP algorithm.

RIP Overview, History, Standards and Versions

The Routing Information Protocol (RIP) has been the most popular interior routing protocol in the TCP/IP suite for many years. The history of the protocol and how it came to achieve prominence is a rather interesting one. Unlike many of the other important protocols in the TCP/IP suite, RIP was not first developed formally using the [RFC standardization process](#). Rather, it evolved as a [de facto industry standard](#) and only became an Internet standard later on.

Early History of RIP

The history of RIP shares some commonality with that of another networking heavyweight: Ethernet. Like the formidable LAN technology, RIP's roots go back to that computing pioneer, Xerox's Palo Alto Research Center (PARC). At the same time that Ethernet was being developed for tying together local area networks, PARC created a higher layer protocol to run on Ethernet called the *Xerox PARC Universal Protocol (PUP)*. PUP required a routing protocol, so Xerox created a protocol called the *Gateway Information Protocol (GWINFO)*. This was later renamed the *Routing Information Protocol* and used as part of the *Xerox Network System (XNS)* protocol suite.

RIP entered the mainstream when developers at the University of California at Berkeley adapted it for use in the Berkeley Standard Distribution (BSD) of the UNIX operating system. RIP first appeared in BSD version 4.2 in 1982, where it was implemented as the UNIX program *routed* (pronounced “route-dee”, not “rout-ed”—the “d” stands for *daemon*, a common UNIX term for a server process.)

BSD was (and still is) a very popular operating system, especially for machines connected to the early Internet. As a result, RIP was widely deployed and became the industry standard for internal routing protocols. It was used both for TCP/IP and also other protocol suites. In fact, a number of other routing protocols, such as the RTP protocol in the AppleTalk suite, were based on this early version of RIP.

RIP Standardization

For a while, the BSD implementation of `routed` was actually considered the standard for the protocol itself. However, this was not a formally defined standard, and this meant there was no formal definition of how exactly it functioned. This led to slight differences in various implementations of the protocol over time. To resolve potential interoperability issues between implementations, the IETF formally specified RIP in the Internet standard RFC 1058, *Routing Information Protocol*, published in June 1988. This RFC was based directly on the BSD `routed` program. This original version of RIP is now also sometimes called *RIP version 1* or *RIP-1* to differentiate it from later versions.

RIP's popularity was due in large part to its inclusion in BSD; this was in turn a result of the relative simplicity of the protocol. RIP uses the [distance-vector algorithm](#) (also called the Bellman-Ford algorithm after two of its inventors) to determine routes. Each router maintains a routing table containing entries for various networks or hosts in the internetwork. Each entry contains two primary pieces of information: the address of the network or host, and the distance to it, measured in *hops*, which is simply the number of routers that a datagram must pass through to get to its destination.

RIP Operational Overview, Advantages and Limitations

On a regular basis, each router in the internetwork sends out its routing table in a special message on each of the networks to which it is connected, using [UDP](#). Other routers receive these tables and use them to update their own tables. This is done by taking each of the routes they receive and adding an extra hop. For example, if router *A* receives an indication from router *B* that network *N1* is 4 hops away, then since router *A* and router *B* are adjacent, the distance from router *A* to *N1* is 5. After a router updates its tables, it in turn sends out this information to other routers on its local networks. Over time, routing distance information for all networks propagates over the entire internetwork.

RIP is straight-forward in operation, easy to implement, and undemanding of router processing power, which makes it attractive especially in smaller autonomous systems. There are, however, some important limitations that arise due to the simplicity of the protocol. For starters, hops are often not the best metric to use in selecting routes. There are also a number of problems that arise with the algorithm itself. These include slow convergence (delays in having all routers agree on the same routing information) and problems dealing with network link failures.

RIP includes several special features to resolve some of these issues, but others are inherent limitations of the protocol. For example, RIP only supports a maximum of 15 hops between destinations, making it unsuitable for very large autonomous systems, and this cannot be changed.



Key Concept: The *Routing Information Protocol (RIP)* is one of the oldest and most popular interior routing protocols. It uses a distance-vector algorithm with each router maintaining a table indicating how to reach various networks in the autonomous system and the distance to it in hops. RIP is popular because it is well-established and simple, but has a number of important limitations.

Development of RIP Version 2 (RIP-2) and RIPng for IPv6

Some other issues with RIP were a result of its having been developed in the early 1980s when TCP/IP was still in its infancy. Over time, as the use of TCP/IP protocols changed, RIP became outdated. In response, *RIP Version 2*, or *RIP-2* was created in the early 1990s. RIP-2 defines a new message format for RIP and includes a number of new features, including support for classless addressing, authentication, and the use of multicasting instead of broadcasting to improve network performance. It was first defined in RFC 1388, *RIP Version 2 Carrying Additional Information*, published in January 1993. This RFC was revised in RFC 1723, and finalized in RFC 2453, *RIP Version 2*, November 1998.

Over two decades after it was first created, RIP continues to be a popular interior routing protocol. Its limitations have led to many internetworking experts hoping that the protocol would eventually “go away”, in favor of newer protocols like [OSPF](#) that are superior on a strictly technical basis. Some have gone so far as to sarcastically suggest that maybe it would be best if RIP would “R. I. P.” (“rest in peace”). ☺ Once a protocol becomes popular, however, it’s hard to resist momentum, and RIP is likely to continue to be used for many years to come.

In order to ensure that RIP can work with TCP/IP in the future, it was necessary to define a version that would work with the new [Internet Protocol version 6 \(IPv6\)](#). In 1997, RFC 2080 was published, titled *RIPng for IPv6*. The *ng* stands for *next generation*—recall that IPv6 is also sometimes called *IPng*. RIPng is not just a new version of RIP, like RIP-2, but is defined as a new standalone protocol. It is, however, based closely on the original RIP and RIP-2 standards. A distinct protocol (as opposed to a revision of the original) was needed due to the changes made between IPv4 and IPv6, though RIP and RIPng work in the same basic way. RIPng is sometimes also called *RIPv6*.



Key Concept: The original version of RIP has the fewest features and is now called *RIP-1*. *RIP-2* was created to add support for classless addressing and other capabilities. *RIPng* is the version created for compatibility with IPv6.

RIP Route Determination Algorithm and Metric

As I mentioned in [the overview topic on TCP/IP routing protocols](#), one of the defining characteristics of any routing protocol is the *algorithm* it uses for determining routes. RIP falls into the class of protocols that use a *distance-vector* or *Bellman-Ford* routing algorithm.

To help you better understand exactly how RIP determines routes, I will now discuss the specific implementation of the algorithm for RIP and provide an example so you can see exactly how RIP determines routes and propagates information across a network.

RIP Routing Information and Route Distance Metric

The job of RIP, like any routing protocol, is to provide a mechanism for exchanging information about routes so routers can keep their routing tables up to date. Each router in an RIP internetwork keeps track in its routing table of all networks (and possibly individual hosts) in the internetwork. For each network or host, the device includes a variety of information, of which the following are the most important:

- ☉ The address of the network or host.
- ☉ The distance from that router to the network or host.
- ☉ The first hop for the route: the device to which datagrams must first be sent to eventually get to the network or host.

In theory, the distance metric can be any assessment of cost, but in RIP, distance is measured in *hops*. As you probably already know, in TCP/IP vernacular, a datagram makes a *hop* when it passes through a router. Thus, the RIP distance between a router and a network measures the number of routers that the datagram must pass through to get to the network. If a router connects to a network directly, then the distance is 1 hop. If it goes through a single router, the distance is 2 hops, and so on. In RIP, a maximum of 15 hops are allowed for any network or host. The value 16 is defined as *infinity*, so an entry with 16 in it means “this network or host is not reachable”.

RIP Route Determination Algorithm

On a regular basis, each router running RIP will send out its routing table entries to provide information to other routers about the networks and hosts it knows how to reach. Any routers on the same network as the one sending out this information will be able to update their own tables based on the information they receive. Any router that receives a message from another router on the same network saying it can reach network *X* at a cost of *N*, knows it can reach network *X* at a cost of *N+1* by sending to the router it received the message from.

RIP Route Determination and Information Propagation Example

Let's take a specific example to help us understand better how routes are determined using RIP. Consider a relatively simple internetwork with four individual networks, connected as follows:

- ☉ Router A (RA) connects Network 1 (N1) to Network 2 (N2).
- ☉ Routers B (RB) and C (RC) connect Network 2 to Network 3 (N3).
- ☉ Router D (RD) connects Network 3 to Network 4 (N4).

This example autonomous system is illustrated in [Figure 172](#).

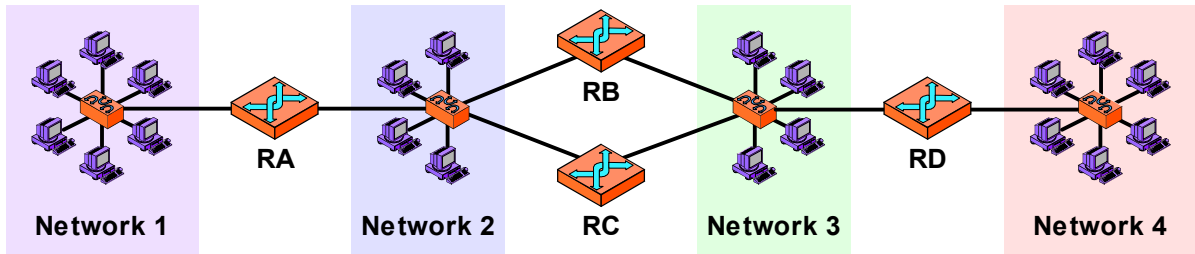

Figure 172: Example RIP Autonomous System

This is an example of a simple autonomous system that contains four physical networks and four routers.

Now, let's suppose that we just turned on router *RA*. It sees that it is directly connected to *N1* and *N2*, so it will have an entry in its routing table indicating that it can reach *N1* at a cost of 1, which we can represent as $\{N1,1\}$. Information about Network 1 will propagate from Router *RA* across the internetwork in the following sequence of steps (which you can observe graphically in [Figure 173](#)):

1. Router *A* sends out an RIP message containing the entry $\{N1,1\}$ on each of the networks to which it is connected. There are no other routers on *N1*, so nothing happens there. But *RB* and *RC* are on *N2* so they receive the information.
2. *RB* and *RC* will look in their routing tables to see if they already have entries for *N1*. Assuming neither does, they will each create a routing table entry $\{N1,2\}$ for Router *A*. This means "I can reach Network 1 at a cost of 2 hops by sending to Router *A*".
3. *RB* and *RC* will each send their own routing tables out over the networks to which they are connected: *N2* and *N3*. This will contain the entry $\{N1,2\}$. *RA* will receive that message on *N2* but will ignore it, since it knows it can reach *N1* directly (cost of 1, which is less than 2). But Router *D* will receive the message on *N3*.
4. *RD* will examine its routing table, and seeing no entry for *N1* will add the entry $\{N1,3\}$ for *RB* or *RC*. Of course, either one will work, so which is chosen depends entirely on whether *RD* received information about *N1* first from *RB* or *RC*.
5. *RD* will send the entry $\{N1,3\}$ on Network 4, but of course there are no other routers there to hear it.

RIP is designed so that a routing entry is only replaced if information is received about a **shorter** route; ties go to the incumbent, if you will. This means that once *RD* creates an entry for *N1* with a cost of 3 going through *RB*, if it receives information that it can reach *N1* at the same cost of 3 through *RC*, it will ignore it. Similarly, if it gets *RC*'s info first, it will ignore the information from *RB*.

Naturally, this same propagation scheme will occur for all the other networks as well; I have just shown only how information about *N1* moves from router to router. For example, Router *A* will eventually install an entry for *N4* saying that it is reachable at a cost of 3 going through either *RB* or *RC*: this will be either $\{N4,RB,3\}$ or $\{N4,RC,3\}$.

This propagation of network routing information occurs on a regular basis, and also when the structure of the network changes (due to either intentional changes in topography or failure of links or routers). When this happens the change information will move through the

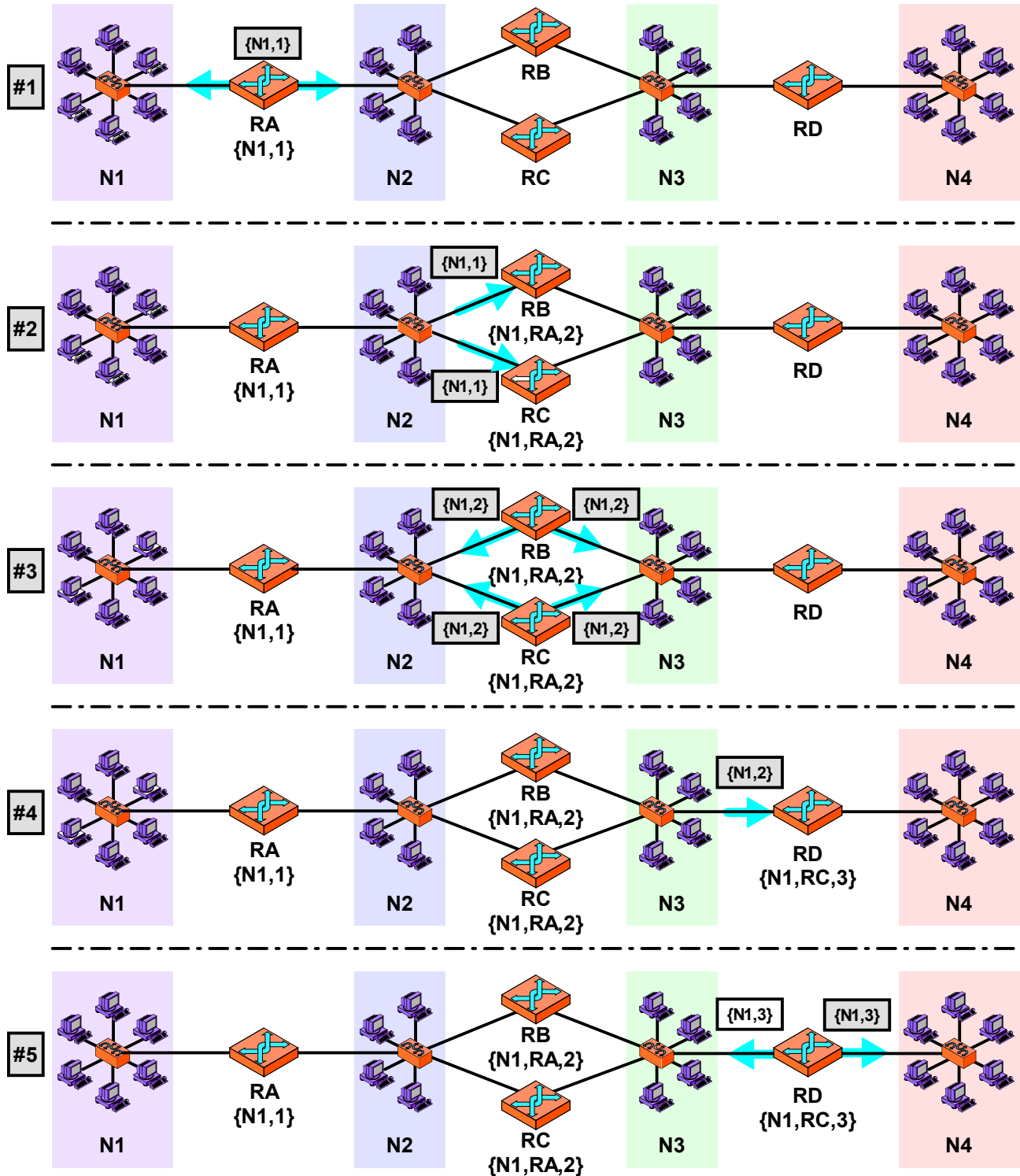

Figure 173: Propagation of Network Routing Information Using RIP

This composite diagram illustrates the five steps in propagating route information about network *N1* from *RA* to the rest of the autonomous system. In Step #1 the information is sent from *RA* to both of its connected networks. In Step #2 it reaches routers *RB* and *RC*, which then know they can reach *N1* through *RA* at a cost of one additional hop. In Step #3 these two routers send this information on their networks, and in Step #4 it reaches *RD*. In Step #5 *RD* sends out the information, but no other routers are around to receive it.

internetwork so that all routers are eventually updated. For example, suppose a connection were added from Router C to Network 1. If Router D previously had the entry {N1, RB, 3}, it would eventually change this to {N1, RC, 2}, since it could now reach N1 more quickly by going through Router C.

Default Routes

In some cases it is not convenient for every network or host in a large internetwork to be fully specified with its own routing entry. In this case it may be advantageous to specify a *default route* for the network to use in reaching hosts or networks for which they have no information. The most common example of this is when an autonomous system connects to the public Internet through a single router. Except for that router, the rest of the local network doesn't need to know how to access the Internet.

In RIP, information about a default route is communicated by having routers intended to handle such traffic send information about a “dummy” network with the address 0.0.0.0. This is treated as if it were a regular network when information about routes is propagated on the internetwork using RIP messages, but other devices recognize this special address and understand it means a default route.



Note: The algorithm description in this topic is the basic one used by RIP. This is modified in certain ways to address some of the problems that can occur in special circumstances due to how the algorithm works. Topics later in this chapter describe these problems and the special features RIP includes to address them.



Key Concept: Routing information is propagated between routers in RIP using a simple algorithm. On a regular basis, each router sends out RIP messages that specify what networks it can reach, and how many hops to reach them. Other routers directly connected to that one know that they can then reach those networks through that router at a cost of one additional hop. So if router A sends a message saying it can reach network X for a cost of N hops, each other router that connects directly to A can reach network X for a cost of N+1 hops. It will put that information into its routing table, unless it knows of an alternate route through another router that has a lower cost.

RIP General Operation, Messaging and Timers

RIP is a protocol for exchanging routing information, so its operation can best be described in terms of the messages used to exchange this information, and the rules for when messages are sent. The RIP software in each router sends messages and takes other actions both in reaction to certain events and in response to triggers set off by timers. Timers are also used to determine when routing information should be discarded if not updated.

RIP Messages and Basic Message Types

Communication between RIP software elements in routers on an internetwork is accomplished through the use of *RIP messages*. These messages are sent using the [User Datagram Protocol \(UDP\)](#), with reserved UDP port number 520 for RIP-1 and RIP-2, and 521 for RIPng. Thus, even though RIP is considered part of layer three like other routing protocols, it behaves more like an application in terms of how it sends messages. The exact format of the message is version-dependent, and all three formats (for RIP, RIP-2 and RIPng) are described in detail in [their own section](#). RIP messages can be either sent to a specific device, or can be sent out for multiple devices to receive. If directed to one device they are sent unicast; otherwise, they are either broadcast (in RIP) or multicast (RIP-2 and RIPng).

There are only two basic message types for all three versions of RIP:

- 🕒 **RIP Request:** A message sent by a router to another router asking it to send back all or part of its routing table.
- 🕒 **RIP Response:** A message sent by a router containing all or part of its routing table. Note that despite the name, this message is **not** sent just in response to an *RIP Request* message, as we will see. So it's not really that great a name... oh well.



Note: The original RIP also defined a few other message types: *Traceon*, *Traceoff* and a special message type reserved for use by Sun Microsystems. These are obsolete and no longer used, and were removed from the RIP-2 and RIPng standards.

RIP Update Messaging and the 30-Second Timer

RIP Request messages are sent under special circumstances, when a router requires that it be provided with immediate routing information. The most common example of this is when a router is first powered on. After initializing, the router will typically send an *RIP Request* on its attached networks to ask for the latest information about routes from any neighboring routers. It is also possible for *RIP Request* messages to be used for diagnostic purposes.

A router receiving an *RIP Request* will process it and send an *RIP Response* containing either all of its routing table, or just the entries the *Request* asked for, as appropriate. Under normal circumstances, however, routers do not usually send *RIP Request* messages asking specifically for routing information. Instead, a special timer is used on each RIP router that goes off every 30 seconds. (This timer is not given a specific name in the RIP standards; it is just “the 30 second timer”).

Each time the timer expires, an unsolicited (unrequested) broadcast/multicast is made of an *RIP Response* message containing the router's entire routing table. The timer is then reset and 30 seconds later goes off again, causing another routine *RIP Response* to be sent. This process ensures that route information is regularly sent around the internet, so routers are always kept up to date about routes.



Key Concept: RIP uses two basic message types, the *RIP Request* and *RIP Response*, both of which are sent using the *User Datagram Protocol (UDP)*. *RIP Response* messages, despite their name, are used both for routine periodic routing table updates as well as to reply to *RIP Request* messages. Requests are sent only in special circumstances, such as when a router first joins a network.

Preventing Stale Information: The Timeout Timer

When a router receives routing information and enters it into its routing table, that information cannot be considered valid indefinitely. In our example in the previous topic, suppose that after Router *B* installs a route to Network 1 through Router *A*, the link to between *RA* and *N2* fails. Once this happens, *N1* is no longer reachable from *RB*, but *RB* has a route indicating it **can** reach Network 1.

To prevent this problem, routes are only kept in the routing table for a limited amount of time. A special *Timeout* timer is started whenever a route is installed in the routing table. Whenever the router receives another *RIP Response* with information about that route, the route is considered “refreshed” and its *Timeout* timer is reset. As long as the route continues to be refreshed, the timer will never expire.

If, however, *RIP Responses* containing that route stop arriving, the timer will eventually expire. When this happens, the route is marked for deletion, by setting the distance for the route to 16 (which you may recall is *RIP infinity* and indicates an unreachable network). The default value for the *Timeout* timer is usually 180 seconds. This allows several periodic updates of a route to be missed before a router will conclude that the route is no longer reachable.

Removing Stale Information: The Garbage-Collection Timer

When a route is marked for deletion, a new *Garbage-Collection* timer is also started. “Garbage collection” is a computer industry phrase for a task that looks for deleted or invalid information and cleans it up. Thus, this is a timer that counts a number of seconds before the newly invalid route will be actually removed from the table. The default value for this timer is 120 seconds.

The reason for using this two-stage removal method is to give the router that declared the route no longer reachable a chance to propagate this information to other routers. Until the *Garbage-Collection* timer expires, the router will include that route, with the “unreachable” metric of 16 hops, in its own *RIP Responses*, so other routers are informed of the problem with that route. When the timer expires the route is deleted. If during the garbage collection period a new *RIP Response* for the route is received, then as you might expect the deletion process is aborted: the *Garbage-Collection* timer is cleared, the route is marked as valid again, and a new *Timeout* timer starts.

Triggered Updates

In addition to the two situations already described where an *RIP Response* is sent—in reply to an *RIP Request* and on expiration of the 30-second timer—an *RIP Response* is also sent out when a route changes. This action, an enhancement to basic RIP operation called a *triggered update*, is intended to ensure that information about route changes is propagated as fast as possible across the internetwork, to help reduce the “slow convergence” problem in RIP. For example, in the case we just saw where a route timed out and the *Garbage-Collection* timer was started, a triggered update would be sent out about the now-invalid route immediately. [This is described in more detail in the topic on RIP special features.](#)

RIP Protocol Limitations and Problems

The simplicity of the Routing Information Protocol is often given as the main reason for its popularity; I certainly have mentioned this enough times in this section. Simplicity is great most of the time, but an unfortunate “price” of simplicity in too many cases is that problems crop up, usually in unusual cases or special situations. And so it is with RIP: the straightforward distance-vector algorithm and operation mechanism work well most of the time, but they have some important weaknesses. We need to examine these problems to understand both the limitations of RIP and some of the complexities that have been added to the protocol to resolve them.

Problems With RIP’s Basic Algorithm and Implementation

The most important area where we find serious issues with RIP is with the basic function of the distance-vector algorithm described earlier in this section, and the way that messages are used to implement it. There are four main problems here: slow convergence, routing loops, “counting to infinity” and “small infinity”.

Slow Convergence

The distance-vector algorithm is designed so that all routers share all their routing information regularly. Over time then, all routers eventually end up with the same information about the location of networks and which are the best routes to use to reach them. This is called *convergence*. Unfortunately, the basic RIP algorithm is rather slow to achieve convergence. It takes a long time for all routers to get the same information, and in particular, it takes a long time for information about topology changes to propagate.

Consider the worst-case situation of two networks separated by 15 routers. Since routers normally send *RIP Response* messages only every 30 seconds, a change to one of this pair of networks might not be seen by the router nearest the other one until many minutes have elapsed—an eternity in networking terms.

The slow convergence problem is even more pronounced when it comes to the propagation of route failures. Failure of a route is only detected through the expiration of the 180-second *Timeout* timer, so that adds up to three minutes more delay before convergence can even begin.

Routing Loops

A routing loop occurs when Router *A* has an entry telling it to send datagrams for Network 1 to Router *B*, and Router *B* has an entry saying that datagrams for Network 1 should be sent to Router *A*. **Larger loops can also exist:** Router *A* says to send to *B*, which says to send to *C*, which says to send to *A*.

While under normal circumstances these loops should not occur, they can happen in special situations. RIP does not include any specific mechanism to detect or prevent routing loops; the best it can do is try to avoid them.

“Counting To Infinity”

A special case of slow convergence can lead to a routing loop situation where one router passes bad information to another router, which sends more bad information to another router and so on. This causes a situation where the protocol is sometimes described as *unstable*.; the problem is called *counting to infinity* for reasons we will soon see.

To understand how this happens, let's modify [the example we looked at in the topic describing the RIP algorithm](#) (you may find it helpful to refer to [Figure 174](#) as you follow this discussion). Suppose that the internetwork is operating properly for a while. Router *B* has an entry indicating it can reach Network 1 through Router *A* at a cost of 2. Now, say the link from Network 1 to Router *A* fails. After the *Timeout* timer for Network 1 expires on Router *A*, *RA* will change the metric for *N1* to 16 to indicate that it is unreachable. In the absence of any mechanism to force *RA* to immediately inform other routers of this failure, they will remain “in the dark”. Router *B* will continue to think it can reach Network 1 through Router *A*.

Now, suppose *RB*'s regular 30 second timer goes off before *RA*'s next broadcast. *RB* will send its normal routing table, **which contains a route to Network 1 at a cost of 2**. Router *A* will see this and say “Hey, look, Router *B* has a route to Network 1 with a cost of 2! That means I can get there with a cost of 3, which sure beats my current cost of 16; let's use that!” So, Router *A* installs this route and cancels its *Timeout* timer. Of course, this is bogus information—Router *A* doesn't realize that Router *B*'s claim of being able to reach Network 1 was based on old information from Router *A* itself!

It only gets worse from there. When it is time for Router *A*'s regular routing table update, it will broadcast a route to Network 1 with a cost of 3. Now, Router *B* will then see this and say “Hmm. Well, my route to Network 1 is through Router *A*. Router *A* was saying before that its cost was 1, but now it says the cost is 3. That means I have to change my cost to 4”.

RB will later send back to *RA*, and back and forth they will go, each incrementing the cost two at a time. This won't stop until the value of “infinity” (16) is hit—thus the name *counting to infinity*. At this point both routers will finally agree that Network 1 is unreachable, but as you can see, it takes a long time for it to happen.

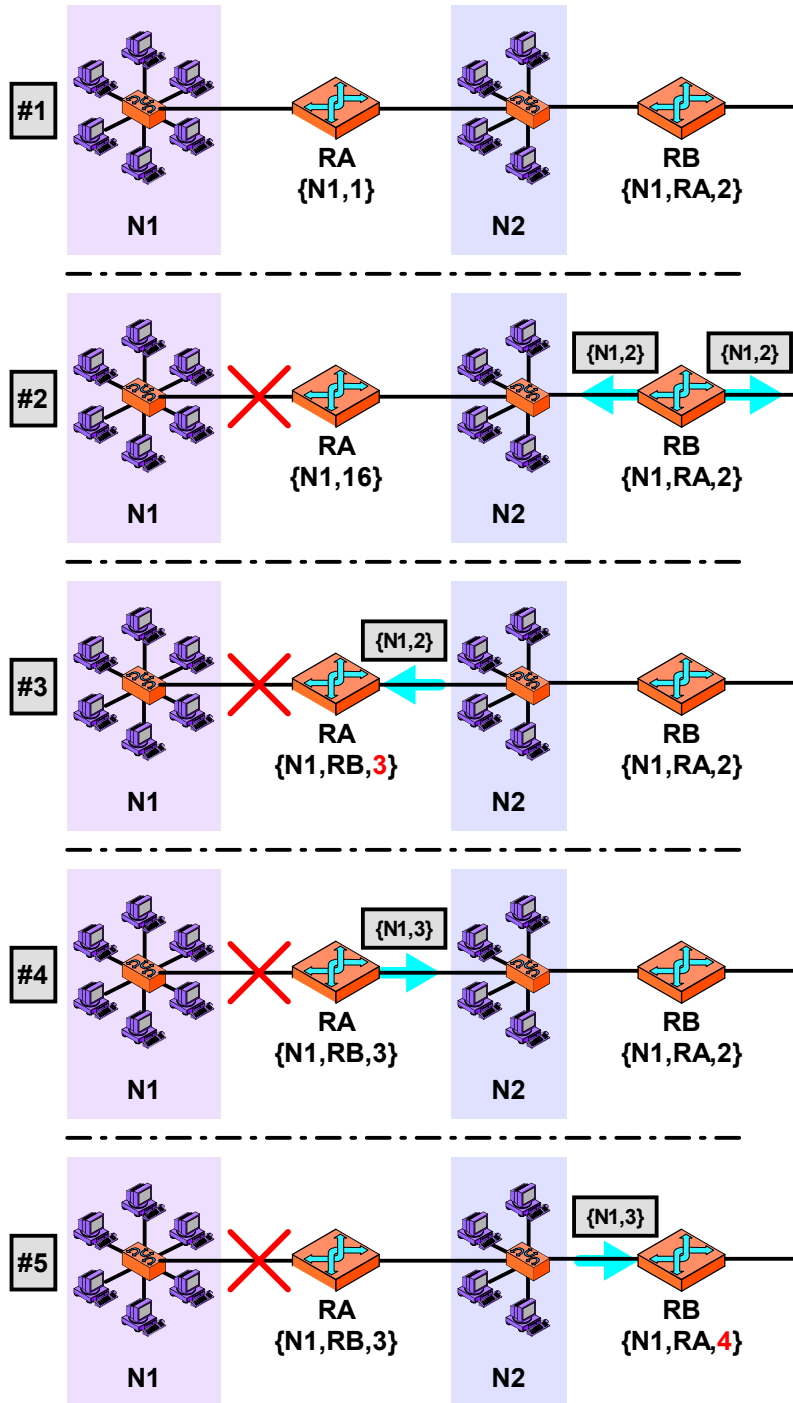

Figure 174: The RIP “Counting To Infinity” Problem

This composite diagram shows part of the autonomous system illustrated in [Figure 172](#). The top panel (#1) shows the normal state of the network, with *RB* able to reach *N1* through *RA* at a cost of 2. In #2, the link between *RA* and *N1* is broken. *RA* changes its cost to reach *N1* to 16 (RIP infinity). In #3, Before *RA* can send out this update to *RB*, it receives a routine RIP message from *RB* indicating that *N1* can be reached for a cost of 2. *RA* is then fooled into thinking it can use *RB* as an alternate route to *N1*, even though *RB*'s information originally came from *RA* in the first place. In #4, *RA* then sends this bogus information out, which is received by *RB* in #5. *RB* then increases its cost to 4, and on its next cycle will send this to *RA*, which will increase its cost to 5, and so on. This cycle will continue, with both routers “counting to infinity” (16).

“Small Infinity”

The use of a relatively small value of “infinity” limits the slow convergence problem. Even in a situation where we “count to infinity” as we just saw, the total amount of time elapsed is at least manageable; imagine if “infinity” were defined as say, 1000! Unfortunately, the drawback of this is that it limits the size of the internetwork that can be used for RIP.

Many people balk at the limit of a span of 15 routers in RIP, but to be honest I think it is much ado about, well, if not nothing, then at least “nothing much”. The 15 value is not a limit on the total number of routers you can use, just on the number of routers between any two networks. Consider that most internetworks are set up hierarchically; even if you have a rather complex four-level hierarchy you wouldn't be close to the 15-router limit. In fact, you could create a huge autonomous system with thousands of routers without having more than 15 routers between any two devices. So this is only a limitation for the very largest of autonomous systems.

On the other hand, RIP's need to send out its entire routing table many times each hour makes it a potentially poor choice for a large internetwork regardless of the “infinity=16” issue. In an internetwork with many routers, the amount of traffic RIP generates can become excessive.



Key Concept: One of the most important problems with the operation of RIP is *slow convergence*, which describes the fact that it can take a long time for information about changes to a network to propagate between routers. One specific instance of this problem is the *counting to infinity* problem, in which out-of-date information causes many bogus RIP messages to be exchanged between routers about an unreachable network.

To be fair, these problems are mostly general to distance-vector routing algorithms and not RIP in particular. Some of them are corrected through the implementation of specific changes to the algorithm or the rules under which RIP messages are sent, as described in [the next topic](#). According to RFC 2453, there was actually a proposal to increase RIP's “infinity” to a number larger than 16, but this would have caused compatibility problems with older devices (which would view any route with a metric of 16 or higher as unreachable) so it was rejected.

Problems With RIP's Metric

In addition to these concerns with the algorithm itself, RIP is also often criticized because of its choice of metric. There are two related issues here:

- **Hop Count As A Distance Metric:** Simply put, hop count is a poor metric of the cost of sending a datagram between two networks. I believe the use of hop count as the metric in RIP is partially due to the desire for simplicity (it's easy to make the protocol work when hop count is all the routers need to consider) and partially an artifact of RIP being a 20-plus-year-old protocol. Decades ago computers were slow, so each time a

datagram passed through a router there was probably a significant delay. Hop count was not a perfect metric even then, but I think it had more correspondence with how long it took to move a datagram across an internetwork than it does today.

Modern routers are lightning fast, making hop count a flawed way of measuring network distance. The number of hops taken often has no correlation with the actual amount of time it takes to move data across a route. To take an extreme case, consider two networks that are connected by a direct dial-up telephone networking link using 56K modems, and also connected by a sequence of three routers using high-speed DS-3 lines. RIP would consider the 56K link a better route because it has fewer hops, even though clearly it is much slower.

- ☉ **Lack Of Support For Dynamic (Real-Time) Metrics:** Even if RIP were to use a more meaningful metric than hop count, the algorithm requires that the metric be fixed for each link. There is no way to have RIP calculate the best route based on real-time data about various links the way protocols like [OSPF](#) do.

These problems are built into RIP and cannot be resolved easily. Interestingly, some RIP implementations apparently do let administrators “fudge” certain routes to compensate for the limitations of the hop count metric. For example, the routers on either end of the 56K link mentioned above could be configured so they considered the 56K link to have a hop count of 10 instead of 1. This would cause any routes using the link to be more “expensive” than the DS-3 path. This is clever, but hardly an elegant or general solution.



Note: In addition to the rather long list of problems above, there were also some specific issues with the first version of RIP. Some of the more important of these include lack of support for CIDR, lack of authentication, and the performance reduction caused by the use of broadcasts for messaging. [These were mostly addressed through extensions in RIP-2.](#)

RIP Special Features For Resolving RIP Algorithm Problems

The simplicity of the Routing Information Protocol is its most attractive quality, but also leads to [certain problems with how it operates](#). Most of these limitations are related to the basic algorithm used for determining routes, and the method of message passing used to implement the algorithm. In order for RIP to be a useful protocol, it was necessary that some of these issues be addressed, in the form of changes to the basic RIP algorithm and operational scheme we explored earlier in this section.

The solution to problems that arise due to RIP being too simple is to add complexity, in the form of features that add more intelligence to the way that RIP operates. Let’s take a look at four of these: split horizon, split horizon with poisoned reverse, triggered updates and hold-down.

Split Horizon

The “counting to infinity” problem is one of the most serious issues with the basic RIP algorithm. In the example in the previous topic, the cause of the problem is immediately obvious: after Network 1 fails and Router A notices it go down, Router B “tricks” Router A into thinking it has an alternate path to Network 1 by sending Router A a route advertisement to N1.

If you think about it, it doesn't really make sense—under **any** circumstances—to have Router B send an advertisement to Router A about a network that Router B can only access through Router A in the first place. In the case where the route fails it causes this problem, which is obviously a good reason not to do it. But even when the route is operational, what is the point of Router B telling Router A about it? Router A already has a shorter connection to the network and will therefore **never** send traffic intended for Network 1 to Router B anyway.

Clearly, the best solution is simply to have Router B not include any mention of the route to Network 1 in any *RIP Response* messages it sends to Router A. We can generalize this by adding a new rule to RIP operation: when a router sends out an *RIP Response* on any of the networks to which it is connected, it omits any route information that was originally learned from that network. This feature is called *split horizon*, since the router effectively splits its view of the internetwork, sending different information on certain links than on others.

With this new rule, let's consider the behavior of Router B. It has an interface on Network 2, which it shares with Router A. It will therefore not include any information on routes it originally obtained from Router A when sending on N2. This will prevent the “counting to infinity” loop we saw in the previous topic. Similarly, since Router D is on Network 3, Router B will not send any information about routes it got from Router D when sending on Network 3.

Note, however, that split horizon may not **always** solve the “counting to infinity” problem, especially in the case where multiple routers are connected indirectly. The classic example would be three routers configured in a triangle. In this situation, problems may still result due to data that is propagated in two directions between any two routers. In this case, the “hold down” feature may be of assistance (see below).

Split Horizon With Poisoned Reverse

This is an enhancement of the basic split horizon feature. Instead of omitting routes learned from a particular interface when sending *RIP Response* messages on that interface, we include those routes but set their metric to “RIP infinity”, 16. So in the example above, Router B **would** include the route to Network 1 in its transmissions on Network 2, but it would say the cost to reach N1 was 16, instead of its real cost (which is 2).

The “poisoned reverse” refers to the fact that we are *poisoning* the routes that we want to make sure routers on that interface don't use. Router A will see Router B advertise Network 1 but with a cost of 16, which serves as an explicit message to Router A: “there is absolutely no way for you to get to Network 1 through Router B”. This provides more

insurance than the regular split horizon feature, because if the link from Router A to Network 1 dies as we described in the previous topic, Router A will know for certain that it can't try to get a new route through Router B. Figure 175 shows how split horizon with poisoned reverse works.

This technique also works in normal circumstances (meaning, when there is no issue such as a broken link to a network). In that case, Router A will receive updates from RB with a cost of 16 on a periodic basis, but RA will never try to reach Network 1 through Router B anyway, since it is directly connected to Network 1 (cost of 1).

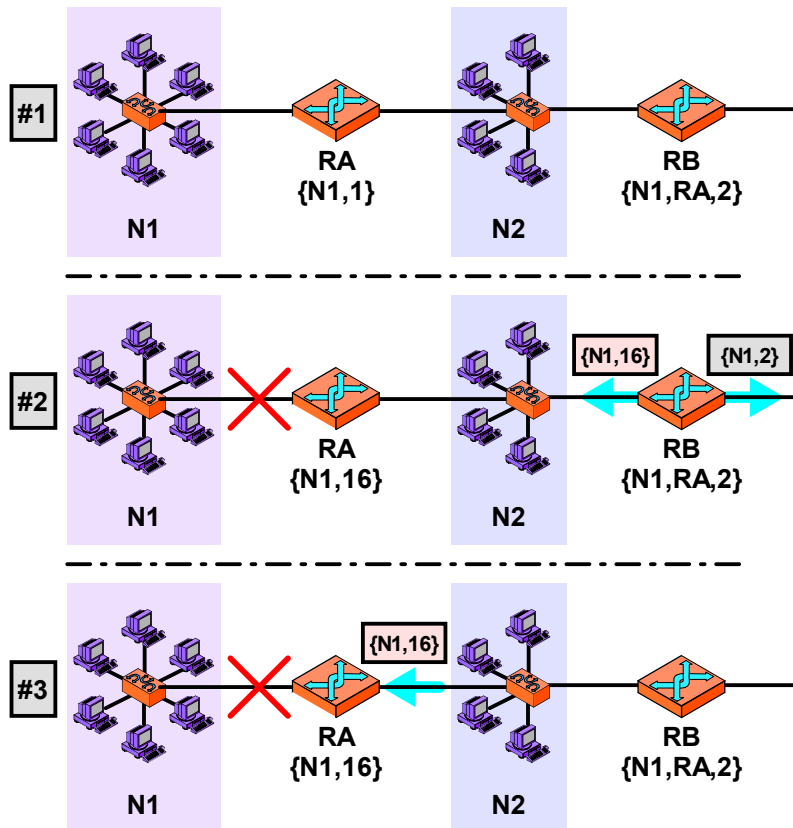

Figure 175: RIP Problem Solving Using Split Horizon With Poisoned Reverse

The top panel in this diagram (#1) shows the same example as in Figure 174. In #2, as before, the link between RA and N1 is broken, just as RB is ready to send out its routine update. However, the split horizon with poisoned reverse feature means it sends different messages on its two links; on the network that connects it to RA, it sends a route advertisement with a cost of 16. In #3, Router A receives this, which it will discard, ensuring no counting to infinity problem occurs. On RA's next cycle it will update RB to tell it that N1 is no longer reachable.

Triggered Updates

The routing loop problem we looked at in the previous topic occurred because Router *B* advertised Router *A*'s route back to Router *A*. There's another aspect of the problem that is also significant: after Router *A* discovered that the link to Network *1* failed, it had to wait up to 30 seconds until its next scheduled transmission time to tell other routers about the failure.

For RIP to work well, when something significant happens we want to tell other routers on the internetwork immediately. For this reason, a new rule should be added to the basic RIP router operation: whenever a router changes the metric for a route it is required to (almost) immediately send out an *RIP Response* to tell its immediate neighbor routers about the change. If these routers, seeing this change, update their routing information, they are in turn required to send out updates. Thus, the change of any network route information causes cascading updates to be sent throughout the internetwork, significantly reducing the slow convergence problem. Note that this includes removal of a route due to expiration of its *Timeout* timer, since the first step in route removal is setting the route's metric to 16, which triggers an update.

You probably noticed that I said that triggered updates were sent “almost” immediately. In fact, before sending a triggered update a route waits a random amount of time, from 1 to 5 seconds. This is done to reduce the load on the internetwork that would result from many routers sending update messages nearly simultaneously.

Hold-Down

Split horizon tries to solve the “counting to infinity” problem by suppressing the transmission of invalid information about routes that fail. For extra insurance, we can implement a feature that changes how devices receiving route information process it in the case of a failed route. The *hold down* feature works by having each router start a timer when they first receive information about a network that is unreachable. Until the timer expires, the router will discard any subsequent route messages that indicate the route is in fact reachable. A typical hold-down timer runs for 60 or 120 seconds.

The main advantage of this technique is that a router won't be confused by receiving spurious information about a route being accessible when it was just recently told that the route was no longer valid. It provides a period of time for out-of-date information to be flushed from the system, which is valuable especially on complex internetworks. The addition of hold-down to split horizon can also help in situations where split horizon alone is not sufficient to prevent counting to infinity, such as when a trio of routers are linked in a “triangle”, as discussed earlier.

The main disadvantage of hold-down is that it forces a delay in a router responding to a route once it is fixed. Suppose that a network “hiccup” causes a route to go down for five seconds. After the network is up again, routers will want to again know about this. However, the hold-down timer must expire before the router will try to use that network again. This makes internetworks using hold-down relatively slow to respond to corrected routes, and may lead to delays in accessing networks that fail intermittently.



Key Concept: Four special features represent changes to RIP operation that ameliorate or eliminate the problems with the operation of the basic protocol. *Split horizon* and *split horizon with poisoned reverse* prevent having a router send invalid route information back to the router from which it originally learned the route. *Triggered updates* reduce the slow convergence problem by causing immediate propagation of changed route information. Finally, *hold-down* may be used to provide robustness when information about a failed route is received.

Again, while I called the items above “features”, at least some of them are really necessary to ensure proper RIP functionality. Therefore, they are generally considered standard parts of RIP, and most were described even in the earliest RIP documents. However, sometimes performance or stability issues may arise when these techniques are used, especially in combination. For this reason different RIP implementations may omit some features. For example, hold-down slows down route recovery and may not be needed when other features such as split horizon are used. As always, care must be taken to ensure that all routers are using the same features, or even greater problems may arise.

Also see [the specific section on RIP-2](#) for a description of the *Next Hop* feature that helps reduce convergence and routing problems when RIP is used.



RIP Version-Specific Message Formats and Features

The Routing Information Protocol (RIP) has been in widespread use for over two decades. During that time, internetworks and internetworking technologies have changed. To keep up with the times, RIP has also evolved, and today has three different versions. The basic operation of all three is fairly similar, and was therefore described in [the common section on concepts and operation](#). As you might expect, there are also some differences between the versions (or we wouldn't need versions!) One of the more important of these is the format used for RIP messages in each version, and the meaning and use of the fields within that format.

In this section I describe the message format used by each of the three versions of RIP, as well as certain specific features not common to all versions. I begin with the original RIP, also now known as *RIP Version 1*. I then describe the updated version of RIP called *RIP Version 2* or *RIP-2*. Finally, I discuss *RIPng*, also sometimes called *RIPv6*, the version of RIP used for IP version 6 (IPv6). (Note that this is not technically a new version of the original RIP protocol but a new protocol closely based on RIP versions 1 and 2.

RIP Version 1 (RIP-1) Message Format

RIP [evolved as an industry standard](#) and was popularized by its inclusion in the Berkeley Standard Distribution of UNIX (BSD UNIX). This first version of RIP (now sometimes called RIP-1 to differentiate it from later versions), was eventually standardized in RFC 1058. As part of this standard the original RIP-1 message format was defined, which of course serves RIP-1 itself, and is also the basis for the format used in later versions.

RIP-1 Messaging

As explained in [the general discussion on RIP operation](#), route information is exchanged in RIP through the sending of two different types of RIP messages: *RIP Request* and the *RIP Response*. These are transmitted as regular TCP/IP messages using the [User Datagram Protocol \(UDP\)](#), using UDP [reserved port number 520](#). This port number is used as follows:

- ☉ *RIP Request* messages are sent to UDP destination port 520. They may have a source port of 520 or may use an [ephemeral port number](#).
- ☉ *RIP Response* messages sent in reply to an *RIP Request* are sent with a source port of 520, and a destination port equal to whatever source port the *RIP Request* used.
- ☉ Unsolicited *RIP Response* messages (sent on a routine basis and not in response to a request) are sent with both the source and destination ports set to 520.

RIP-1 Message Format

The basic message format for RIP-1 is described in [Table 121](#) and illustrated in [Figure 176](#).

Table 121: RIP Version 1 (RIP-1) Message Format

Field Name	Size (bytes)	Description																					
Command	1	Command Type: Identifies the type of RIP message being sent. A value of 1 indicates an <i>RIP Request</i> , while 2 means an <i>RIP Response</i> . Originally, three other values and commands were also defined: 3 and 4 for the <i>Traceon</i> and <i>Traceoff</i> commands, and 5 reserved for use by Sun Microsystems. These are obsolete and no longer used.																					
Version	1	Version Number: Set to 1 for RIP version 1.																					
Must Be Zero	2	Reserved: Field reserved; value must be set to all zeroes.																					
RIP Entries	20 to 500, in increments of 20	RIP Entries: The “body” of an RIP message consists of 1 to 25 sets of <i>RIP entries</i> . These entries contain the actual route information that the message is conveying. Each entry is 20 bytes long and has the following subfields:																					
		<table border="1"> <thead> <tr> <th>Subfield Name</th> <th>Size (bytes)</th> <th>Description</th> </tr> </thead> <tbody> <tr> <td>Address Family Identifier</td> <td>2</td> <td>Address Family Identifier: A fancy name for a field that identifies the type of address in the entry. We are using IP addresses, for which this field value is 2.</td> </tr> <tr> <td>Must Be Zero</td> <td>2</td> <td>Reserved: Field reserved; value must be set to all zeroes.</td> </tr> <tr> <td>IP Address</td> <td>4</td> <td>IP Address: The address of the route we are sending information about. No distinction is made between addresses of different types of devices in RIP, so the address can be for a network, a subnet or a single host. It is also possible to send an address of all zeroes, which is interpreted as the “default route” for other devices on the network to use for reaching routes with no specified routing entries. This is commonly used to allow a network to access the Internet.</td> </tr> <tr> <td>Must Be Zero</td> <td>4</td> <td>Reserved: Field reserved; value must be set to all zeroes.</td> </tr> <tr> <td>Must Be Zero</td> <td>4</td> <td>Reserved: Field reserved; value must be set to all zeroes. Yes, two of them in a row. ☺</td> </tr> <tr> <td>Metric</td> <td>4</td> <td>Metric: The distance for the network indicated by the IP address in the <i>IP Address</i> field. Values of 1 to 15 indicate the number of hops to reach the network, while a value of 16 represents “infinity” (an unreachable destination). See the general discussion of the RIP algorithm for more information on the use of metrics.</td> </tr> </tbody> </table>	Subfield Name	Size (bytes)	Description	Address Family Identifier	2	Address Family Identifier: A fancy name for a field that identifies the type of address in the entry. We are using IP addresses, for which this field value is 2.	Must Be Zero	2	Reserved: Field reserved; value must be set to all zeroes.	IP Address	4	IP Address: The address of the route we are sending information about. No distinction is made between addresses of different types of devices in RIP, so the address can be for a network, a subnet or a single host. It is also possible to send an address of all zeroes, which is interpreted as the “default route” for other devices on the network to use for reaching routes with no specified routing entries. This is commonly used to allow a network to access the Internet.	Must Be Zero	4	Reserved: Field reserved; value must be set to all zeroes.	Must Be Zero	4	Reserved: Field reserved; value must be set to all zeroes. Yes, two of them in a row. ☺	Metric	4	Metric: The distance for the network indicated by the IP address in the <i>IP Address</i> field. Values of 1 to 15 indicate the number of hops to reach the network, while a value of 16 represents “infinity” (an unreachable destination). See the general discussion of the RIP algorithm for more information on the use of metrics.
		Subfield Name	Size (bytes)	Description																			
		Address Family Identifier	2	Address Family Identifier: A fancy name for a field that identifies the type of address in the entry. We are using IP addresses, for which this field value is 2.																			
		Must Be Zero	2	Reserved: Field reserved; value must be set to all zeroes.																			
		IP Address	4	IP Address: The address of the route we are sending information about. No distinction is made between addresses of different types of devices in RIP, so the address can be for a network, a subnet or a single host. It is also possible to send an address of all zeroes, which is interpreted as the “default route” for other devices on the network to use for reaching routes with no specified routing entries. This is commonly used to allow a network to access the Internet.																			
		Must Be Zero	4	Reserved: Field reserved; value must be set to all zeroes.																			
		Must Be Zero	4	Reserved: Field reserved; value must be set to all zeroes. Yes, two of them in a row. ☺																			
Metric	4	Metric: The distance for the network indicated by the IP address in the <i>IP Address</i> field. Values of 1 to 15 indicate the number of hops to reach the network, while a value of 16 represents “infinity” (an unreachable destination). See the general discussion of the RIP algorithm for more information on the use of metrics.																					

If you're like me, the first thing that comes to mind looking at this message format is this: what's with all the extra space? I mean, we have four different fields that are reserved (must be zero), and even most of the other fields are larger than they need to be (a metric of 1 to

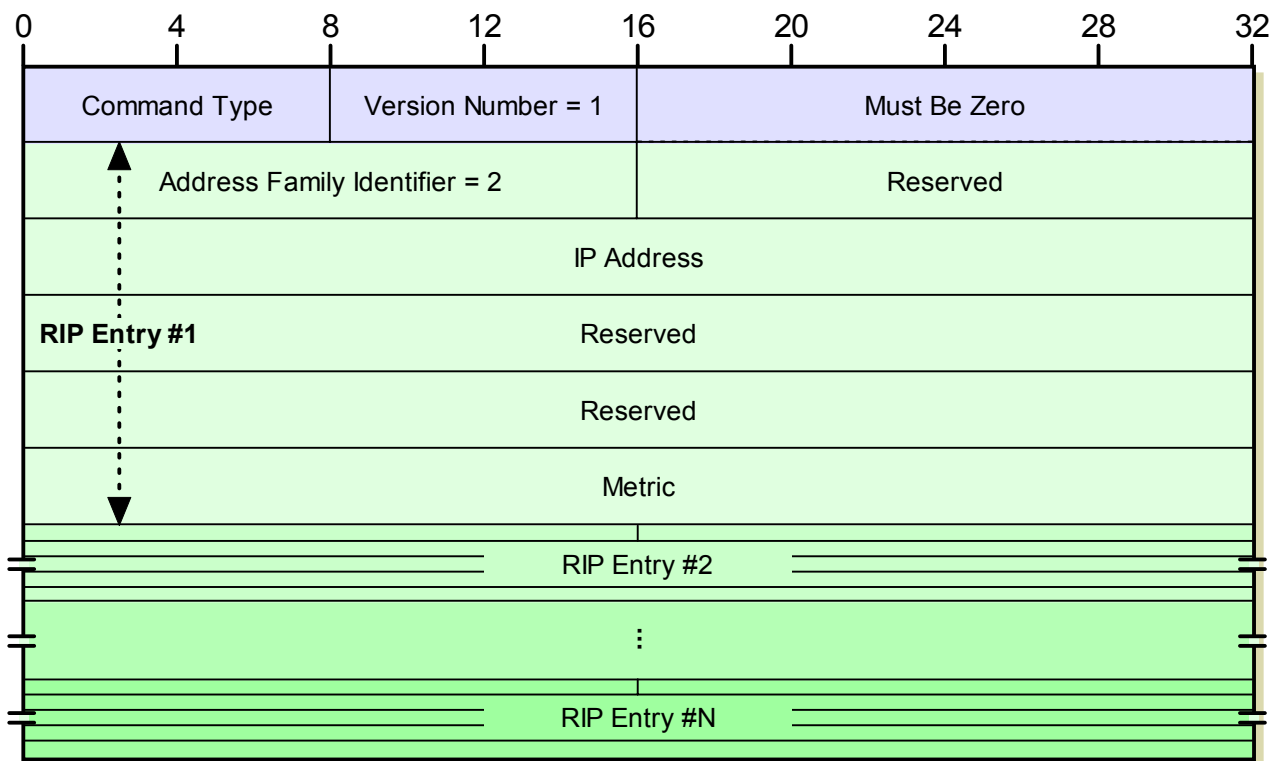

Figure 176: RIP Version 1 (RIP-1) Message Format

The RIP-1 message format can contain up to 25 *RIP Entries*. Here, *RIP Entry #1* is shown here with each of its constituent subfields.

16 needs only 4 bits, not 32.) The command type and version number could easily have been made only 4 bits each as well (if not less.) And why bother having a two-byte field to identify the address type when we are only going to deal with IP addresses anyway?

This seeming wastefulness is actually an artifact of the generality of the original RIP design. The protocol was intended to be able to support routing for a variety of different internet-working protocols, not just IP. (Remember that it wasn't even originally developed with IP in mind.) So, the *Address Family Identifier* was included to specify address type, and RIP entries were made large enough to handle large addresses. IP only requires 4 bytes per address so some of the space is not used.

RIP-1 Version-Specific Features

Since RIP version 1 was the first version of the protocol, its features formed the basis for future RIP versions; it doesn't really have any version-specific features. What RIP-1 has is a number of limitations, such as a lack of support for specifying classless addresses and no means for authentication. [RIP version 2](#) was created to address some of RIP-1 shortcomings. As we will see in the next topic, RIP-2's features put to good use those "Must Be Zero" bytes in the RIP-1 format.



Key Concept: *RIP-1* was the first version of the Routing Information Protocol and is the simplest in terms of operation and features. The bulk of an *RIP-1* message consists of sets of *RIP* entries that specify route addresses and the distance to the route in hops.

RIP Version 2 (RIP-2) Message Format and Features

The original Routing Information Protocol (*RIP-1*) has a number of problems and limitations. As the TCP/IP protocol suite evolved and changed, *RIP-1*'s problems were compounded by it becoming somewhat out of date, unable to handle newer IP features. There were some who felt that the existence of newer and better interior routing protocols meant that it would be best to just give up on *RIP* entirely and move over to something like [Open Shortest Path First \(OSPF\)](#).

However, *RIP*'s appeal was never its technical superiority, but its simplicity and ubiquity in industry. By the early 1990s, *RIP* was already in use in many thousands of networks. For those who liked *RIP*, it made more sense to migrate to a newer version that addressed some of *RIP-1*'s shortcomings than to go to an entirely different protocol. To this end, a new version of the protocol, *RIP Version 2 (RIP-2)* was developed, and initially published in RFC 1388 in 1993. It is now defined in RFC 2453, [RIP Version 2](#), published in November 1998.

RIP-2 Version-Specific Features

RIP-2 represents a very modest change to the basic Routing Information Protocol. *RIP-2* works in the same basic way as *RIP-1* (part of why I was able to describe the operation of both in the same general section.) In fact, the new features introduced in *RIP-2* are described as **extensions** to the basic protocol, conveying the fact that they are layered upon regular *RIP-1* functionality. The five key *RIP-2* extensions are:

- ☉ **Classless Addressing Support and Subnet Mask Specification:** When *RIP-1* was developed, the use of subnets in IP (as described in RFC 950) had not yet been formally defined. It was still possible to use *RIP-1* with subnets, through the use of a heuristic to determine if the destination is a network, subnet or host. However, there was no way to clearly specify the subnet mask for an address using *RIP-1* messages.

RIP-2 adds explicit support for subnets by allowing a subnet mask within the route entry for each network address. It also provides support for [variable-length subnet masking \(VLSM\)](#) and [classless addressing \(CIDR\)](#).

- ☉ **Next Hop Specification:** In *RIP-2*, each *RIP* entry includes a space where an explicit IP address can be entered as the next hop router for datagrams intended for the network in that entry. This feature can help improve efficiency of routing by eliminating unnecessary extra hops for datagrams sent to certain destinations.

One common use of this field is when the most efficient route to a network is through a

router that is not running RIP. Such a router will not exchange RIP messages and would therefore not normally be selected by RIP routers as a next hop for any network. The explicit *Next Hop* field allows the router to be selected as the next hop regardless of this situation.

- 🕒 **Authentication:** RIP-1 included no authentication mechanism, which is a problem because it could potentially allow a malicious host to muck up an internetwork by sending bogus RIP messages around. RIP-2 provides a basic authentication scheme, which allows routers to ascertain the identity of a router before it will accept RIP messages from it.
- 🕒 **Route Tag:** Each RIP-2 entry includes a *Route Tag* field, where additional information about a route can be stored. This information is propagated along with other data about the route as RIP entries are sent around the internet. A common use of this field is when a route is learned from a different autonomous system, to identify the autonomous system from which the route was obtained.
- 🕒 **Use of Multicasting:** To help reduce network load, RIP-2 allows routers to be configured to use [multicasts](#) instead of broadcasts for sending out unsolicited *RIP Response* messages. These datagrams are sent out using the special reserved multicast address 224.0.0.9. All routers on an internetwork must obviously use multicast if this is to work properly.

As you can see, many of these extensions require more information to be included with each advertised route. This is where all that “extra space” in the message format of RIP-1 routing entries comes in handy, as we will see shortly.



Key Concept: *RIP-2* is the most recent version of RIP used in IPv4. It includes a number of enhancements over the original RIP-1, including support for subnet masks and classless addressing, explicit next-hop specification, route tagging, authentication and multicast. For compatibility, it uses the same basic message format as RIP-1, putting the extra information required for its new features into some of the unused fields of the RIP-1 message format.

***RIP-2* Messaging**

RIP-2 messages are exchanged using the same basic mechanism as RIP-1 messages. Two different message types exist, *RIP Request* and *RIP Response*. They are sent using the [User Datagram Protocol \(UDP\)](#) using UDP [reserved port number](#) 520. The semantics for the use of this port is the same as for RIP-1. For convenience, I repeat the description here:

- 🕒 *RIP Request* messages are sent to UDP destination port 520. They may have a source port of 520 or may use an [ephemeral port number](#).
- 🕒 *RIP Response* messages sent in reply to an *RIP Request* are sent with a source port of 520, and a destination port equal to whatever source port the *RIP Request* used.
- 🕒 Unsolicited *RIP Response* messages (sent on a routine basis and not in response to a request) are sent with both the source and destination ports set to 520.

RIP-2 Message Format

The basic message format for RIP-2 is also pretty much the same as it was for RIP-1, with the *Version* field of course set to 2, to clearly identify the message as being RIP-2. The real differences are in the individual RIP entries, as you can see in [Table 122](#) and [Figure 177](#).

Table 122: RIP Version 2 (RIP-2) Message Format

Field Name	Size (bytes)	Description																					
Command	1	Command Type: Identifies the type of RIP message being sent. A value of 1 indicates an <i>RIP Request</i> , while 2 means an <i>RIP Response</i> .																					
Version	1	Version Number: Set to 2 for RIP version 2.																					
Must Be Zero	2	Reserved: Field reserved; value must be set to all zeroes.																					
Route Table Entries (RTEs)	20 to 500, in increments of 20	<p>Route Table Entries (RTEs): As with RIP-1, the “body” of an RIP-2 message consists of 1 to 25 sets of route information. In RIP-2 these are labeled <i>Route Table Entries</i> or <i>RTEs</i>. Each <i>RTE</i> is 20 bytes long and has the following subfields:</p> <table border="1"> <thead> <tr> <th>Subfield Name</th> <th>Size (bytes)</th> <th>Description</th> </tr> </thead> <tbody> <tr> <td>Address Family Identifier</td> <td>2</td> <td>Address Family Identifier: Same meaning as for RIP-1; value is 2 to identify IP addresses.</td> </tr> <tr> <td>Route Tag</td> <td>2</td> <td>Route Tag: Additional information to be carried with this route.</td> </tr> <tr> <td>IP Address</td> <td>4</td> <td>IP Address: Same as in RIP-1: the address of the route we are sending information about. No distinction is made between address of different types of devices in RIP, so the address can be for a network, a subnet or a single host. It is also possible to send an address of all zeroes, which is interpreted as the “default route” as in RIP-1.</td> </tr> <tr> <td>Subnet Mask</td> <td>4</td> <td>Subnet Mask: The subnet mask associated with this address.</td> </tr> <tr> <td>Next Hop</td> <td>4</td> <td>Next Hop: Address of the device to use as the next hop for the network advertised in this entry.</td> </tr> <tr> <td>Metric</td> <td>4</td> <td>Metric: The distance for the network indicated by the IP address, as in RIP-1. Values of 1 to 15 indicate the number of hops to reach the network (as described in the general discussion of the RIP algorithm) while a value of 16 represents “infinity” (an unreachable destination).</td> </tr> </tbody> </table>	Subfield Name	Size (bytes)	Description	Address Family Identifier	2	Address Family Identifier: Same meaning as for RIP-1; value is 2 to identify IP addresses.	Route Tag	2	Route Tag: Additional information to be carried with this route.	IP Address	4	IP Address: Same as in RIP-1: the address of the route we are sending information about. No distinction is made between address of different types of devices in RIP, so the address can be for a network, a subnet or a single host. It is also possible to send an address of all zeroes, which is interpreted as the “default route” as in RIP-1.	Subnet Mask	4	Subnet Mask: The subnet mask associated with this address.	Next Hop	4	Next Hop: Address of the device to use as the next hop for the network advertised in this entry.	Metric	4	Metric: The distance for the network indicated by the IP address, as in RIP-1. Values of 1 to 15 indicate the number of hops to reach the network (as described in the general discussion of the RIP algorithm) while a value of 16 represents “infinity” (an unreachable destination).
		Subfield Name	Size (bytes)	Description																			
		Address Family Identifier	2	Address Family Identifier: Same meaning as for RIP-1; value is 2 to identify IP addresses.																			
		Route Tag	2	Route Tag: Additional information to be carried with this route.																			
		IP Address	4	IP Address: Same as in RIP-1: the address of the route we are sending information about. No distinction is made between address of different types of devices in RIP, so the address can be for a network, a subnet or a single host. It is also possible to send an address of all zeroes, which is interpreted as the “default route” as in RIP-1.																			
		Subnet Mask	4	Subnet Mask: The subnet mask associated with this address.																			
		Next Hop	4	Next Hop: Address of the device to use as the next hop for the network advertised in this entry.																			
Metric	4	Metric: The distance for the network indicated by the IP address, as in RIP-1. Values of 1 to 15 indicate the number of hops to reach the network (as described in the general discussion of the RIP algorithm) while a value of 16 represents “infinity” (an unreachable destination).																					

As you can see, the unused fields allow the new RIP-2 features to be implemented without changing the basic structure of the RIP entry format. This allows RIP-1 and RIP-2 messages and devices to coexist in the same network. A RIP-2 device can handle both RIP-1 and RIP-2 messages, and will look at the version number to see which version the message is. A RIP-1 device should handle both RIP-2 and RIP-1 messages the same way, simply ignoring the extra RIP-2 fields it doesn't understand.

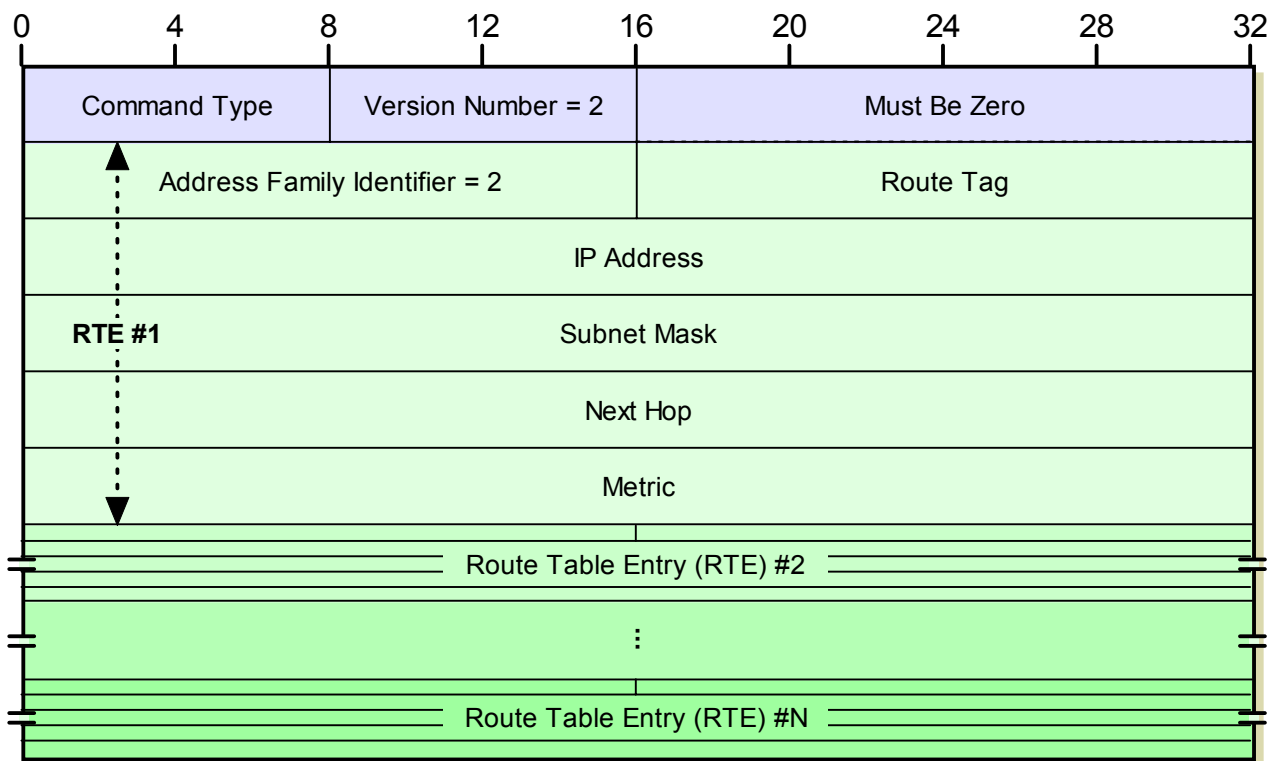

Figure 177: RIP Version 2 (RIP-2) Message Format

The *RIP Entries* of RIP-1 are called *Route Table Entries (RTEs)* in RIP-2; the message format can contain up to 25. The format of *RTE #1* is shown here with each of its subfields (the others are summarized to save space.)



Note: Note that if authentication is used, one of the RTEs contains authentication information, limiting the message to 24 “real” RTEs.

RIPng (“RIPv6”) Message Format and Features

The future of TCP/IP is the new [Internet Protocol version 6 \(IPv6\)](#), which makes some very important changes to IP, especially with regard to addressing. Since IPv6 addresses are different than IPv4 addresses, everything that works with IP addresses must change to function under IPv6. This includes routing protocols, which exchange addressing information.

To ensure a future for the Routing Information Protocol, a new IPv6-compatible version had to be developed. This new version was published in 1997 in RFC 2080, *RIPng for IPv6*, where the *ng* stands for *next generation* (IPv6 is also sometimes called “IP next generation”).

RIPng, which is also occasionally seen as *RIPv6* for obvious reasons, was designed to be as similar as possible to the current version of RIP for IPv4, which is RIP Version 2 (RIP-2). In fact, RFC 2080 describes RIPng as “the minimum change” possible to RIP to allow it to work on IPv6. Despite this effort, it was not possible to define RIPng as just a new version of the older RIP protocol, like RIP-2 was. RIPng is a new protocol, which was necessary because of the significance of the changes between IPv4 and IPv6—especially the change from 32-bit to 128-bit addresses in IPv6, which necessitated a new message format.

RIPng Version-Specific Features

Even though RIPng is a new protocol, a specific effort was made to make RIPng like its predecessors. Its basic operation is almost entirely the same, and it uses the same overall algorithm and operation, as described in [the general section on RIP operation](#). RIPng also does not introduce any specific new features compared to RIP-2, except those needed to implement RIP on IPv6.

RIPng maintains most of the enhancements introduced in RIP-2; some are implemented as they were in RIP-2, while others appear in a modified form. Here's specifically how the five extensions in RIP-2 are implemented in RIPng:

- ☉ **Classless Addressing Support and Subnet Mask Specification:** In IPv6 all addresses are classless, and specified using an address and a prefix length, instead of a subnet mask. Thus, a field for the prefix length is provided for each entry instead of a subnet mask field.
- ☉ **Next Hop Specification:** This feature is maintained in RIPng, but implemented differently. Due to the large size of IPv6 addresses, including a *Next Hop* field in the format of RIPng RTEs would almost double the size of every entry. Since *Next Hop* is an optional feature, this would be wasteful. Instead, when a *Next Hop* is needed, it is specified in a separate routing entry.
- ☉ **Authentication:** RIPng does not include its own authentication mechanism. It is assumed that if authentication and/or encryption are needed, they will be provided using the [standard IPsec features defined for IPv6 at the IP layer](#). This is more efficient than having individual protocols like RIPng perform authentication.
- ☉ **Route Tag:** This field is implemented the same way as it is in RIP-2.
- ☉ **Use of Multicasting:** RIPng uses multicasts for transmissions, using reserved [IPv6 multicast address](#) FF02::9.

RIPng Messaging

There are two basic RIPng message types, *RIP Request* and *RIP Response*, which are exchanged using the [User Datagram Protocol \(UDP\)](#) as with RIP-1 and RIP-2. Since RIPng is a new protocol, it cannot use the same UDP reserved port number 520 used for RIP-1/ RIP-2. Instead, RIPng uses [well-known port number](#) 521. The semantics for the use of this port is the same as those used for port 520 in RIP-1 and RIP-2. For convenience, here are the rules again:

- ☉ *RIP Request* messages are sent to UDP destination port 521. They may have a source port of 521 or may use an [ephemeral port number](#).

- *RIP Response* messages sent in reply to an *RIP Request* are sent with a source port of 521, and a destination port equal to whatever source port the *RIP Request* used.
- Unsolicited *RIP Response* messages (sent on a routine basis and not in response to a request) are sent with both the source and destination ports set to 521.

RIPng Message Format

The message format for RIPng is similar to that of RIP-1 and RIP-2, except for the format of the Route Table Entries; it is shown in [Table 123](#) and [Figure 178](#).

Table 123: RIPng Message Format

Field Name	Size (bytes)	Description															
Command	1	Command Type: Identifies the type of RIPng message being sent. A value of 1 indicates an <i>RIPng Request</i> , while 2 means an <i>RIPng Response</i> .															
Version	1	Version Number: Set to 1 (not 6, since this is the first version of the new protocol RIPng.)															
Must Be Zero	2	Reserved: Field reserved; value must be set to all zeroes.															
Route Table Entries (RTEs)	Variable	Route Table Entries (RTEs): The body of an RIPng message consists of a variable number of <i>Route Table Entries (RTEs)</i> that contain information about routes. Each entry is 20 bytes long and has the following subfields:															
		<table border="1"> <thead> <tr> <th>Subfield Name</th> <th>Size (bytes)</th> <th>Description</th> </tr> </thead> <tbody> <tr> <td>IPv6 Prefix</td> <td>16</td> <td>IPv6 Prefix: The 128-bit IPv6 address of the network whose information is contained in this <i>RTE</i>.</td> </tr> <tr> <td>Route Tag</td> <td>2</td> <td>Route Tag: Additional information to be carried with this route, as defined in RIP-2.</td> </tr> <tr> <td>Prefix Len</td> <td>1</td> <td>Prefix Length: The number of bits of the IPv6 address that is the network portion (the remainder being the host portion). This is the number that normally would appear after the “slash” when specifying an IPv6 network address, and is analogous to an IPv4 subnet mask. See the description of IPv6 prefix notation for more details.</td> </tr> <tr> <td>Metric</td> <td>1</td> <td>Metric: The distance for the network indicated by the IP address, as in RIP-1. Values of 1 to 15 indicate the number of hops to reach the network (as described in the general discussion of the RIP algorithm) while a value of 16 represents “infinity” (an unreachable destination).</td> </tr> </tbody> </table>	Subfield Name	Size (bytes)	Description	IPv6 Prefix	16	IPv6 Prefix: The 128-bit IPv6 address of the network whose information is contained in this <i>RTE</i> .	Route Tag	2	Route Tag: Additional information to be carried with this route, as defined in RIP-2.	Prefix Len	1	Prefix Length: The number of bits of the IPv6 address that is the network portion (the remainder being the host portion). This is the number that normally would appear after the “slash” when specifying an IPv6 network address, and is analogous to an IPv4 subnet mask. See the description of IPv6 prefix notation for more details.	Metric	1	Metric: The distance for the network indicated by the IP address, as in RIP-1. Values of 1 to 15 indicate the number of hops to reach the network (as described in the general discussion of the RIP algorithm) while a value of 16 represents “infinity” (an unreachable destination).
		Subfield Name	Size (bytes)	Description													
		IPv6 Prefix	16	IPv6 Prefix: The 128-bit IPv6 address of the network whose information is contained in this <i>RTE</i> .													
		Route Tag	2	Route Tag: Additional information to be carried with this route, as defined in RIP-2.													
Prefix Len	1	Prefix Length: The number of bits of the IPv6 address that is the network portion (the remainder being the host portion). This is the number that normally would appear after the “slash” when specifying an IPv6 network address, and is analogous to an IPv4 subnet mask. See the description of IPv6 prefix notation for more details.															
Metric	1	Metric: The distance for the network indicated by the IP address, as in RIP-1. Values of 1 to 15 indicate the number of hops to reach the network (as described in the general discussion of the RIP algorithm) while a value of 16 represents “infinity” (an unreachable destination).															

The maximum number of RTEs in RIPng is not restricted to 25 as it is in RIP-1 and RIP-2. It is limited only by the [maximum transmission unit \(MTU\)](#) of the network over which the message is being sent.

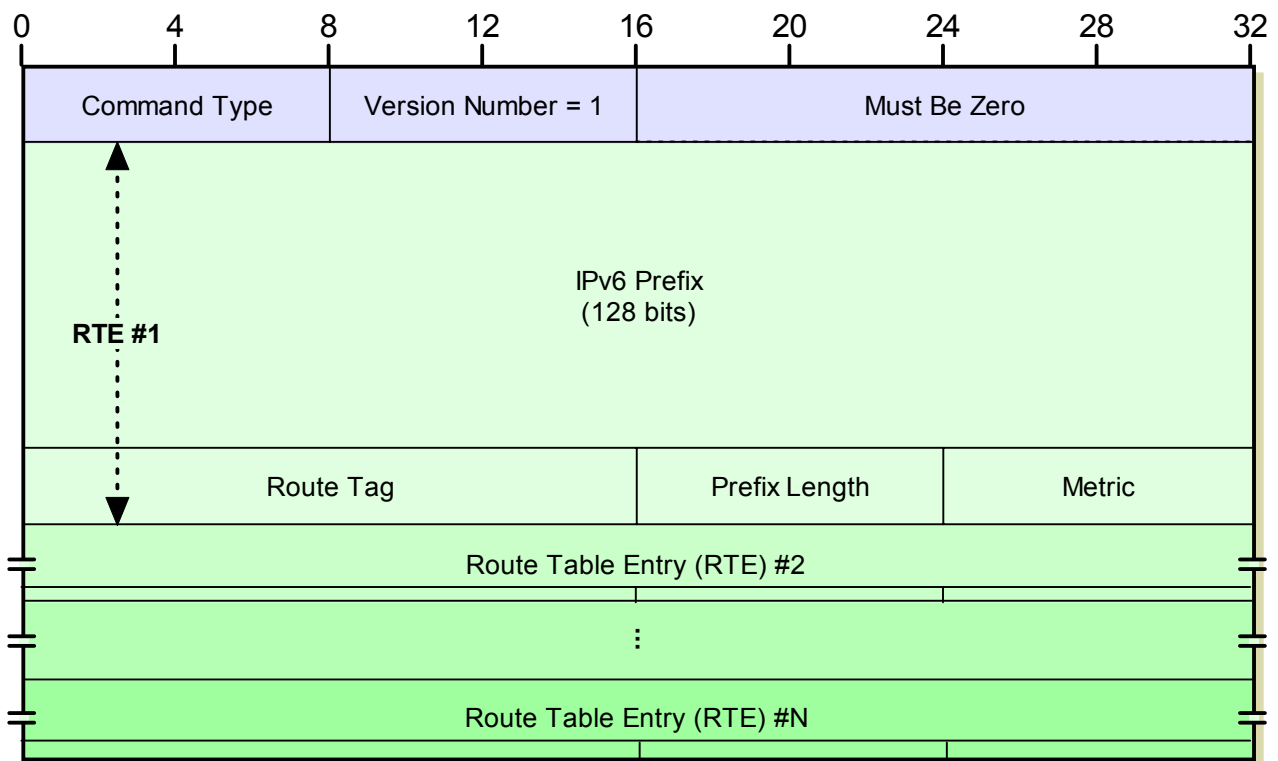

Figure 178: RIPng Message Format

RIPng retains the use of *Route Table Entries (RTEs)* from RIP-2, but their format has been changed to accommodate the much larger IPv6 address size. The limit of 25 entries per message has also been eliminated.



Key Concept: *RIPng* is the version of RIP that was developed for use on IPv6 inter-networks. It is technically a distinct protocol from RIP-1 and RIP-2 but is very similar to both. It retains the enhancements to RIP made in RIP-2, making changes to these features and to the RIP message format where needed for compatibility with IPv6.

When a *Next Hop* needs to be specified, a special *RTE* is included as I mentioned before. This *RTE* is included before all the *RTEs* to which it applies. It has the same basic structure as shown for regular *RTEs* in [Table 123](#), with the *IPv6 Prefix* subfield containing the next hop address, the *Route Tag* and *Prefix Len* fields set to 0, and the *Metric* field set to 255 (0xFF).



Open Shortest Path First (OSPF)

Interior routing protocols using a [distance-vector routing algorithm](#), such as the [Routing Information Protocol \(RIP\)](#), have a long history and work well in a small group of routers. However, they also have some serious limitations in both scalability and performance that makes them poorly-suited to larger autonomous systems or those with specific performance issues. Many organizations that start out using RIP quickly found that its restrictions and issues made it less than ideal.

To solve this problem, a new routing protocol was developed in the late 1980s that uses the more capable (and more complex) [link-state or shortest path first routing algorithm](#). This protocol is called *Open Shortest Path First (OSPF)*. It fixes many of the issues with RIP and allows routes to be selected dynamically based on the current state of the network, not just a static picture of how routers are connected. It also includes numerous advanced features, including support for a hierarchical topology and automatic load sharing amongst routes. On the downside, it is a complicated protocol, which means it is often not used unless it is really needed. This makes it the complement of RIP and is the reason they both have a place in the spectrum of TCP/IP routing protocols.

In this section I provide a condensed explanation of the concepts and operation behind OSPF. As usual, I begin with an overview of the protocol, discussing how it was developed, its versions and the standards that define them. I describe the concepts behind OSPF, including basic topology and the link state database. I then discuss the more complex optional hierarchical topology of routers, and the roles routers play when this topology is used. I briefly explain the method used for determining routes in OSPF, and the general operation and messaging used in the protocol, including a description of the five OSPF message types. I conclude with an illustration of the formats used for OSPF messages.



Note: The difficult thing about networking is that so many protocols and technologies are so involved that each deserves its own book. This is certainly the case with OSPF itself, which is sufficiently complex that the RFC defining OSPF Version 2 is over 240 pages long. Thus, as you have heard me say before, this section, despite including six topics, can only be considered a high-level description of OSPF.

OSPF Overview, History, Standards and Versions

In the early days of TCP/IP, the [Routing Information Protocol \(RIP\)](#) became the standard protocol for routing within an [autonomous system \(AS\)](#), almost by default. RIP had two big things going for it: it was simple and easy to use, and it was included in the popular Berkeley Standard Distribution (BSD) of UNIX starting in 1982. Most organizations using TCP/IP started out with relatively small networks, and were able to use RIP with some degree of success.

However, as we discussed in our look at RIP, [that protocol has some serious technical issues](#), and these are exacerbated when it is used on a larger AS. Many of its problems are due to it being a distance-vector protocol—the algorithm itself simply limits the ability of RIP to choose the best route and adapt to changing network conditions. Other problems with RIP were based on its implementation, such as the selection of a value of 16 for “infinity” that made it impossible to use RIP in a situation where more than 15 hops might occur between devices. Problems such as the lack of classless addressing support were addressed in Version 2 of RIP, but the basic difficulties with the protocol as a whole persist.

Development and Standardization of OSPF

The [Internet Engineering Task Force \(IETF\)](#) recognized that RIP by itself simply would not meet the needs of all autonomous systems on the Internet. They formed a working group in 1988 to develop a new routing protocol based on the more capable *link-state* algorithm, also called *shortest path first (SPF)*. Research into this type of protocol had already begun as early as the 1970s, with some of it conducted on the [ARPAnet](#), the predecessor of the Internet upon which much of TCP/IP was developed.

This new protocol was called *Open Shortest Path First*, or *OSPF*, and its name conveys two of its most important characteristics. The first word refers to the fact that the protocol, like all TCP/IP standards, was developed using the open and public [RFC process](#), so it is not proprietary and no license is required to use it. The *SPF* portion of the name refers to the type of algorithm it uses, which is designed to allow routers to dynamically determine the shortest path between any two networks.

The first version of OSPF was described in RFC 1131, published in October 1989. This was quickly replaced by OSPF Version 2 in July 1991, described in RFC 1247. Since then there have been several revisions to the OSPF Version 2 standard, in RFCs 1583, 2178, and 2328, with the last of these the current standard. OSPF Version 2 is the only version in use today, so it is usually what is meant when people (including myself) refer to “OSPF”.

Overview of OSPF Operation

The fundamental concept behind OSPF is a data structure called the *link-state database (LSDB)*. [Each router in an autonomous system maintains a copy of this database](#), which contains information in the form of a directed graph that describes the current state of the autonomous system. Each link to a network or another router is represented by an entry in the database, and each has an associated cost (or *metric*). The metric can be made to include many different aspects of route performance, not just a simple hop count as is used in RIP.

Information about the autonomous system moves around the autonomous system in the form of *link-state advertisements (LSAs)*, messages that let each router tell the others what it currently knows about the state of the AS. Over time, the information that each router has about the autonomous system converges with that of the others, and they all have the same data. When changes occur to the internetwork, routers send updates to ensure that all the routers are kept up-to-date.

To determine actual routes, each router uses its link-state database to construct a *shortest-path tree*. This tree shows the links from the router to each other router and network, and [allows the lowest-cost route to any location to be determined](#). As new information about the state of the internetwork arrives, this tree can be recalculated, so the best route is dynamically adjusted based on network conditions. When more than one route with an equal cost exists, traffic can be shared amongst the routes.

OSPF Features and Drawbacks

In addition to these obvious benefits of the link-state algorithm, OSPF includes several other features of value especially to larger organizations. It supports authentication for security, and all three major types of IP addressing (classful, subnetted classful and classless). For very large autonomous systems, OSPF also allows routers to be grouped, and [arranged into a hierarchical topology](#). This allows for better organization and improved performance through reduced link-state advertisement traffic.

Naturally, the superior functionality and many features of OSPF do not come without a cost. In this case, the primary cost is that of **complexity**. Where RIP is a simple and easy-to-use protocol, OSPF requires more work and more expertise to properly configure and maintain. This means that even though OSPF is widely considered better than RIP technically, it's not for everyone. The obvious role for OSPF is as a routing protocol for larger or higher-performance autonomous systems, leaving RIP to cover the smaller and simpler internetworks.



Key Concept: *Open Shortest Path First (OSPF)* was developed in the late 1980s to provide a more capable interior routing protocol for larger or more complex autonomous systems that were not being served well by RIP. It uses the dynamic shortest path first or link state routing algorithm, with each router maintaining a database containing information about the state and topology of the internetwork. As changes to the internetwork occur, routers send out updated state information, which allows each router to dynamically calculate the best route to any network at any point in time. OSPF is a complement to RIP in that RIP is simple but limited, where OSPF is more capable but more complicated.

OSPF Basic Topology and the Link State Database (LSDB)

OSPF is designed to facilitate routing in both smaller and larger autonomous systems (ASes). To this end, the protocol supports two topologies. When there is only a small number of routers, the entire AS is managed as a single entity. This doesn't have a specific name, but I call it OSPF *basic topology* to convey the simple nature of the topology, and to contrast it with the hierarchical topology we will explore in [the topic following this one](#).

When OSPF basic topology is used, all the routers in the AS function as peers. Each router communicates routing information with each other one, and each maintains a copy of the key OSPF data structure: the *link-state database (LSDB)*. The LSDB is essentially a computerized representation of the topology of the autonomous system. It is the method by

which routers “see” the state of the links in the autonomous system—thus the name link-state database (and for that matter, the name of [the entire class of link-state algorithms](#) of which OSPF is a part.)

The LSDB is a bit hard to visualize, but is best viewed as a set of data that is equivalent to a graphical picture showing the topology of an autonomous system. In such a diagram, we typically show routers and networks as nodes, and connections between routers and networks as lines that connect them. The OSPF LSDB takes that information and puts it into a table, to allow a router to maintain a virtual picture of all the connections between routers and networks in the AS.

The LSDB therefore indicates which routers can directly reach which other routers, and also which networks each can reach. Furthermore, it stores for each of these links a *cost* to reach the network. This cost is an arbitrary metric that can be set up based on any criteria important to the administrator. OSPF is not restricted to the overly-simple hop-count metric used in RIP.

OSPF Basic Topology and LSDB Example

For example, let's consider the same autonomous system we looked at in our examination of the RIP route determination algorithm. This internetwork has four individual networks, connected as follows:

- ☉ Router *A* (*RA*) connects Network 1 (*N1*) to Network 2 (*N2*).
- ☉ Routers *B* (*RB*) and *C* (*RC*) connect Network 2 to Network 3 (*N3*).
- ☉ Router *D* (*RD*) connects Network 3 to Network 4 (*N4*).

To make this example more interesting, I am also going to add a direct link between *RB* and *RC*; the resulting AS is shown in [Figure 179](#). The LSDB for this autonomous system would look something like [Table 124](#).

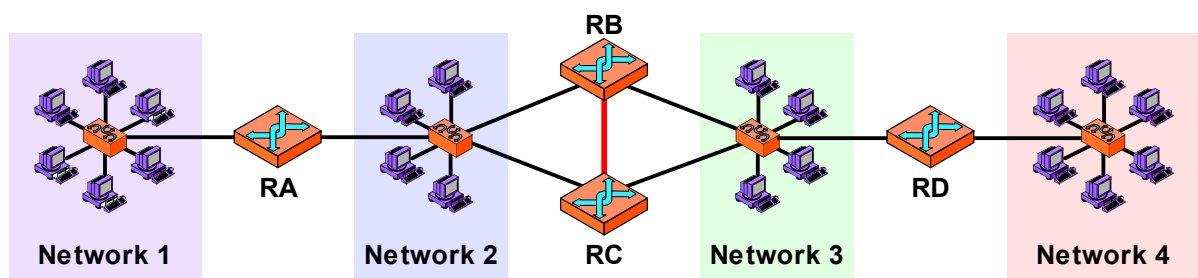

Figure 179: Example OSPF Autonomous System

This is the same AS that we looked at in RIP (as shown in [Figure 172](#)), but with the addition of a link between the two routers RB and RC.

Table 124: Example OSPF Link State Database (LSDB)

To Router / Network	From Router				From Network			
	RA	RB	RC	RD	N1	N2	N3	N4
RA					0	0		
RB			☉			0	0	
RC		☉				0	0	
RD							0	0
N1	☉							
N2	☉	☉	☉					
N3		☉	☉	☉				
N4				☉				

In practice, each of the bullets (“☉”) in [Table 124](#) would be replaced by a metric value indicating the cost to send a datagram from the particular router to another router or network. Note that the chart is symmetric, since if *RB* can reach *RC*, *RC* can reach *RB*. However, the **costs** do not have to be symmetric. It is possible for *RB* to have a metric that is higher for it to send to *RC* than for *RC* to send to *RB*.

Note also that there is no cost to reach a router **from** a network. This ensures that only one cost is “charged” for a router to send to another router over a network—the cost to reach the network from the router. This makes sense, since each router is a member of the network upon which it is connected.

LSDB Information Storage and Propagation

An important point to remember about the LSDB is that even though each router maintains it, the database isn’t constructed from the perspective of the individual router. A router’s LSDB represents the topology of the entire AS, including links between routers that may be rather distant from it. So, for example, *RA* would keep the entire database in its storage area, including information about *RC* and *RD*, to which it does not connect directly.

Since in basic topology all the routers are peers and maintain information for the entire AS, they in theory should have the exact same LSDB contents. When a router is first turned on it may in fact have different LSDB information than its neighbors, but this will be corrected through the exchange of update messages containing link-state advertisements (LSAs). Eventually all routers should converge to the same information. We will see how this works in [the topic on OSPF messaging](#).

OSPF, as an interior routing protocol, is of course used only within the autonomous system. In most cases the AS will be connected to other ASes through one or more of its routers. The routers that connect the AS to other ASes are often called *boundary routers*. These

devices will use OSPF to communicate within the AS, and an exterior routing protocol (typically [BGP](#)) to talk to routers outside the AS. The name *boundary* router refers to the fact that these devices are usually located on the periphery of the AS.



Key Concept: In basic OSPF topology, each of the routers running OSPF is considered a peer of the others. Each maintains a link-state database (LSDB) that contains information about the topology of the entire autonomous system. Each link between a router and network or between two routers is represented by an entry in the LSDB that indicates the cost to send data over the link. The LSDB is updated regularly through the exchange of OSPF link-state advertisements (LSAs).

OSPF Hierarchical Topology, Areas and Router Roles

When the number of routers in an autonomous system (AS) is relatively small, using [the basic topology described in the previous topic](#) works well. Each router maintains a common picture of the network topology in the form of an identical link-state database (LSDB). The routers communicate as peers using link-state advertisements (LSAs). While changes in the AS may cause a router to temporarily have different information than its peers, routine exchanges of data will keep all the LSDBs synchronized and up-to-date, and not that much information needs to be sent around because the AS is small.

This simpler topology does scale reasonably well, and can support many smaller and even moderate-sized autonomous systems. However, as the number of routers increases, the amount of communication required to update LSDBs increases as well. In a very large internetwork with dozens or even hundreds of routers, having all the routers be OSPF peers using basic topology can result in performance degradation. This problem occurs due both to the amount of routing information that needs to be passed around, and also the need for each router to maintain a large LSDB containing every router and network in the entire AS.

OSPF Hierarchical Topology and Areas

To provide better support for these larger internetworks, OSPF supports the use of a more advanced, *hierarchical topology*. In this technique, the autonomous system is no longer considered a single, flat structure of interconnected routers all of which are peers. Instead, a two-level hierarchical topology is constructed. The autonomous system is divided into constructs called *areas*, each of which contains a number of contiguous routers and networks. These areas are numbered, and managed independently by the routers within them, so each area is almost as if it were an autonomous system unto itself. The areas are interconnected so that routing information can be shared between areas, across the entire AS.

The easiest way to understand this hierarchical topology is to consider each area like a “sub-autonomous system” within the autonomous system as a whole. The routers within any area maintain a link-state database containing information about the routers and

networks within that area. Routers within more than one area maintain LSDBs about each area they are a part of, and also link the areas together to share routing information between them.



Key Concept: To allow better control and management over larger internetworks, OSPF allows a large autonomous system to be structured into a hierarchical form. Contiguous routers and networks are grouped into *areas* that connect together using a logical *backbone*. These areas act as the equivalent of smaller autonomous systems within the larger AS, yielding the same benefits of localized control and traffic management that autonomous systems provide for a large internetwork between organizations.

Router Roles in OSPF Hierarchical Topology

The topology described above is hierarchical because the routers in the AS are no longer all peers in a single group. The two-level hierarchy consists of the lower level containing individual areas, and the higher level that connects them together, which is called the *backbone* and is designated as “Area 0”. The routers are no longer all peers, but in fact play different roles depending on where they are located and how they are connected. There are three different labels applied to routers in this configuration:

- **Internal Routers:** These are routers that are only connected to other routers or networks within a single area. They maintain an LSDB for only that area, and really have no knowledge of the topology of other areas.
- **Area Border Routers:** These are routers that connect to routers or networks in more than one area. They maintain an LSDB for each area of which they are a part. They also participate in the backbone.
- **Backbone Routers:** These are routers that are part of the OSPF backbone. By definition, this includes all area border routers, since those routers pass routing information between areas. However, a backbone router may also be a router that connects only to other backbone (or area border) routers, and is therefore not part of any area (other than Area 0).

To summarize: an area border router is always also a backbone router, but a backbone router is not necessarily an area border router.



Note: The classifications above are independent of the designation of a router as being a **boundary** router or not, as described in [the previous topic](#). A boundary router is one that talks to routers or networks outside the AS. Now a boundary router will also often be an area border router or a backbone router, but this is not necessarily the case—a boundary router could be an internal router in one area.

Okay, I bet you are now wondering... what is the point of all this? Well, the point is exactly the same as [the point of using autonomous system architecture in the first place](#). The topology of each area matters only to the devices in that area. This means that changes in

that topology only need to be propagated within the area. It also means that internal routers within Area 1 don't need to know about anything that goes on within Area 2, and don't need to maintain information about any area other than their own. Only the backbone routers (which include at least one area border router within each area) need to know the details of the entire autonomous system. These backbone routers condense information about the areas so that only a “summary” of each area's topology needs to be advertised on the backbone.

Routing in a hierarchical topology AS is performed in one of two ways, depending on the location of the devices. If the source and destination are in the same area, then routing occurs only over networks and routers in that area. If they are in a different area, then the datagram is routed from the source to an area border router in the source's area, over the backbone to an area border router in the destination's area, and then finally, delivered to the destination. Again, this is analogous to how routing works between ASes in the big-picture internetwork.

OSPF Hierarchical Topology Example

I'm sure this all made perfect sense the first time you read it. Uh-huh. ☺ Let's take an example to help make things more concrete. We can use the autonomous system in the preceding topic. This AS is really small enough that it's unlikely one would use hierarchical topology, but it will suffice for sake of illustration. Let's divide this AS into two areas, as follows (see [Figure 180](#)):

- 🕒 **Area 1:** This area would contain *N1*, *RA*, *N2*, *RB* and *RC*.
- 🕒 **Area 2:** This area would contain *RB*, *RC*, *N3*, *RD* and *N4*.

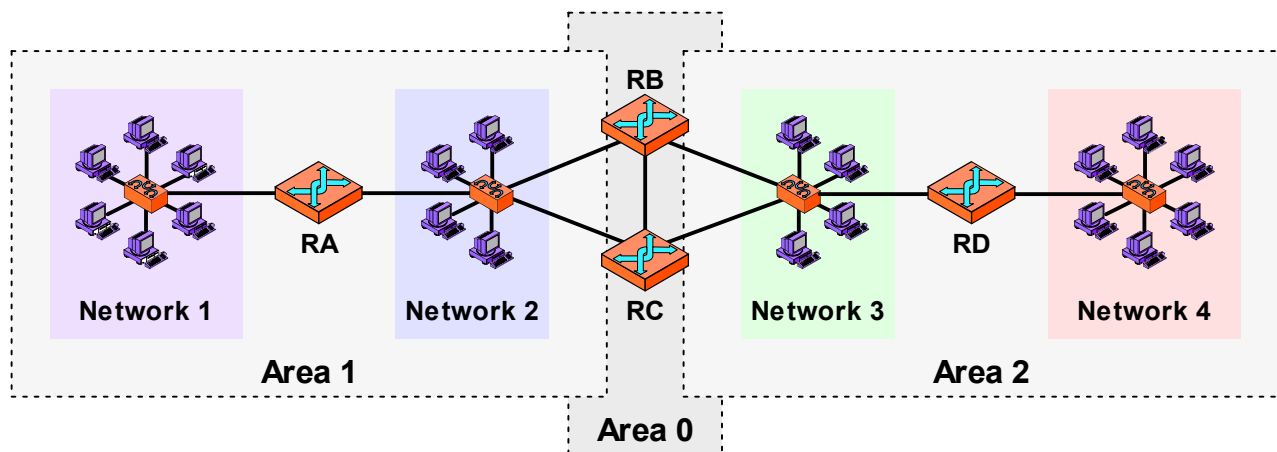

Figure 180: Example OSPF Hierarchical Topology Autonomous System

This is the same AS we saw in [Figure 179](#) but arranged into OSPF hierarchical topology. The AS has been split evenly into Area 1 and Area 2. Area 0 contains *RB* and *RC*, which are area border routers for both Area 1 and Area 2 in this very simple example AS.

In this example, Router *A* and Router *D* are internal routers. Router *B* and Router *C* are area border routers, and comprise the backbone (Area 0) of the internetwork. Routers *A*, *B* and *C* will maintain an LSDB describing Area 1, while Routers *B*, *C* and *D* will maintain an LSDB describing Area 2. Routers *B* and *C* maintain a separate LSDB for the backbone. There is no backbone router other than the area border routers *B* and *C*. However, suppose we had a router *E* that had only direct connections to *RB* and *RC*. This would be a backbone router only.

You have probably already discovered the chief drawback to hierarchical topology: complexity. For large autonomous systems, however, it has significant advantages over making every router a peer. At the same time, the conceptual complexity is made worse by the need for very careful design, especially of the backbone. If the hierarchy is not set up properly, a single failure of a link between routers could disrupt the backbone and isolate one or more of the areas (including all the devices on all networks within the area!)

OSPF Route Determination Using SPF Trees

The key data structure maintained by each router in an OSPF autonomous system (AS) is the *link-state database (LSDB)*. The LSDB contains a representation of the topology of either the entire AS (in [basic topology](#)) or a single area (in [hierarchical topology](#)). As we have seen earlier in this section, each router in the AS or area has the same LSDB, so it represents a neutral view of the connections between routers and networks.

Of course, each router needs to participate in keeping the LSDB up to date, but it also has its own “selfish” concerns. It needs to be able to determine what routes it should use for datagrams it receives from its connected networks—this is, after all, the entire point of a routing protocol.

The SPF Tree

To find the best route from any router, it must determine the shortest path between itself and each router or network in the AS or area. For this, it needs not a neutral view of the inter-network but a view of it from its own perspective.

The router creates this perspective by taking the information in the LSDB and transforming it into a *shortest path first tree* or *SPF tree*. The term “tree” refers to a data structure with a root that has branches coming out that go to other nodes, which in turn have branches. The structure as a whole looks like an upside-down tree. In this case, the SPF tree shows the topology information of the AS or area with the router constructing the tree at the top. Each directly-connected router or network is one step down in the tree; each router or network connected to these first-level routers or networks is then connected, and so on, until the entire AS or area has been represented.

Again, the router doesn't really **make** the tree; it is just an algorithmic calculation performed by the computer within the router. Once this is done, however, this logical construct can be used to calculate the cost for that router to reach any router or network in the AS (or area). In some cases, there may be more than one way to reach a router or network, so the tree is constructed to show only the shortest (lowest-cost) path to the network.

Of course, each router is only responsible for sending a datagram on the next leg of its journey, and not for what happens to the journey as a whole. After the SPF tree is done, the router will create a routing table with an entry for each network, showing the cost to reach it, and also the next hop router to use to reach it.

The SPF tree is created dynamically based on the current state of the LSDB. If the LSDB ever changes, the SPF tree and the routing information are recalculated.



Key Concept: To determine what routes it should use to reach networks in its autonomous system, a router generates a *shortest path first tree (SPF tree)* from its link-state database. This tree contains the same basic information as the LSDB but presents it from the point of view of the router doing the calculation so that router can see the costs of various paths to different networks.

OSPF Route Determination Example

I can almost **see** your eyes glazing over, so let's go back again to the example we have been using in this section. I am going to assume we are looking at the whole AS as a whole in basic topology, for simplicity. In [Table 125](#), I have repeated the LSDB for this AS, and I have taken the liberty of replacing the “☉”s with cost metrics; these are shown in [Figure 181](#) as well. Again, remember there is no cost to reach a router **from** a network, so those links have a non-zero cost only going from the router to the network.

Table 125: Example OSPF Link State Database (LSDB) With Costs

To Router / Network	From Router				From Network			
	RA	RB	RC	RD	N1	N2	N3	N4
RA					0	0		
RB			5			0	0	
RC		5				0	0	
RD							0	0
N1	2							
N2	3	4	3					
N3		5	6	1				
N4				4				

Now, let's construct the SPF tree for *RC*. We can do this in iterations, as follows (this is shown graphically in [Figure 182](#) as well for your convenience):

First Level

To construct the first level of the tree, we look for all devices that *RC* can reach directly. We find:

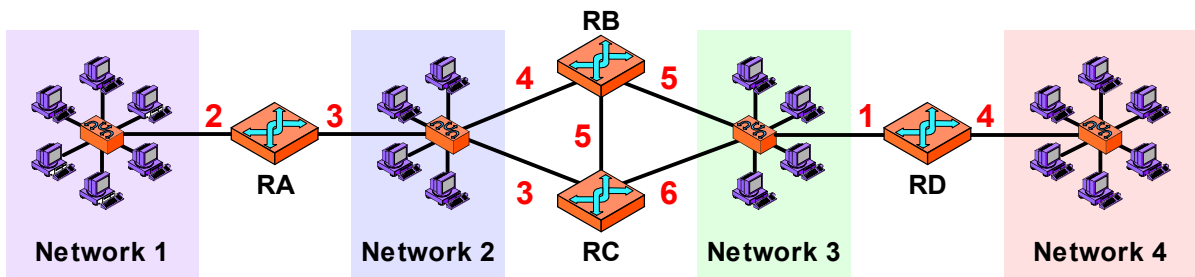

Figure 181: Example OSPF Autonomous System With Costs

This is the same sample AS that is shown in [Figure 179](#), but with costs assigned to each of the links between routers and networks. Costs between routers and networks are applied only in the direction from the router to the network.

- ☉ **RB**, with a cost of 5.
- ☉ **N2**, with a cost of 3.
- ☉ **N3**, with a cost of 6.

Second Level

To construct the second level, we look for all devices that the devices on the first level can reach directly. We then add the cost to reach each device on the first level to the cost of each device at the second level:

- ☉ **RB**: **RB** has a cost of 5 and can reach:
 - ☉ **RC**, with a cost of 5, total cost of 10.
 - ☉ **N2**, with a cost of 4, total cost of 9.
 - ☉ **N3**, with a cost of 5, total cost of 10.
- ☉ **N2**: **N2** has a cost of 3 and can reach:
 - ☉ **RA**, with a cost of 0, total cost of 3.
 - ☉ **RB**, with a cost of 0, total cost of 3.
 - ☉ **RC**, with a cost of 0, total cost of 3.
- ☉ **N3**: **N3** has a cost of 6 and can reach:
 - ☉ **RB**, with a cost of 0, total cost of 6.
 - ☉ **RC**, with a cost of 0, total cost of 6.
 - ☉ **RD**, with a cost of 0, total cost of 6.

You probably can see immediately that we ended up with a number of different paths to the same devices or networks, some of which make no sense. For example, we don't really care about any path that goes to **RC**, since we *are* **RC**! Similarly, we can weed out certain paths immediately because we already have a shorter path to them; taking a path through **RB** to **N3** with a cost of 10 makes no sense when we can go directly at the first level for a cost of 6. So, after separating out the chaff, we end up with the following “wheat” at the second level:

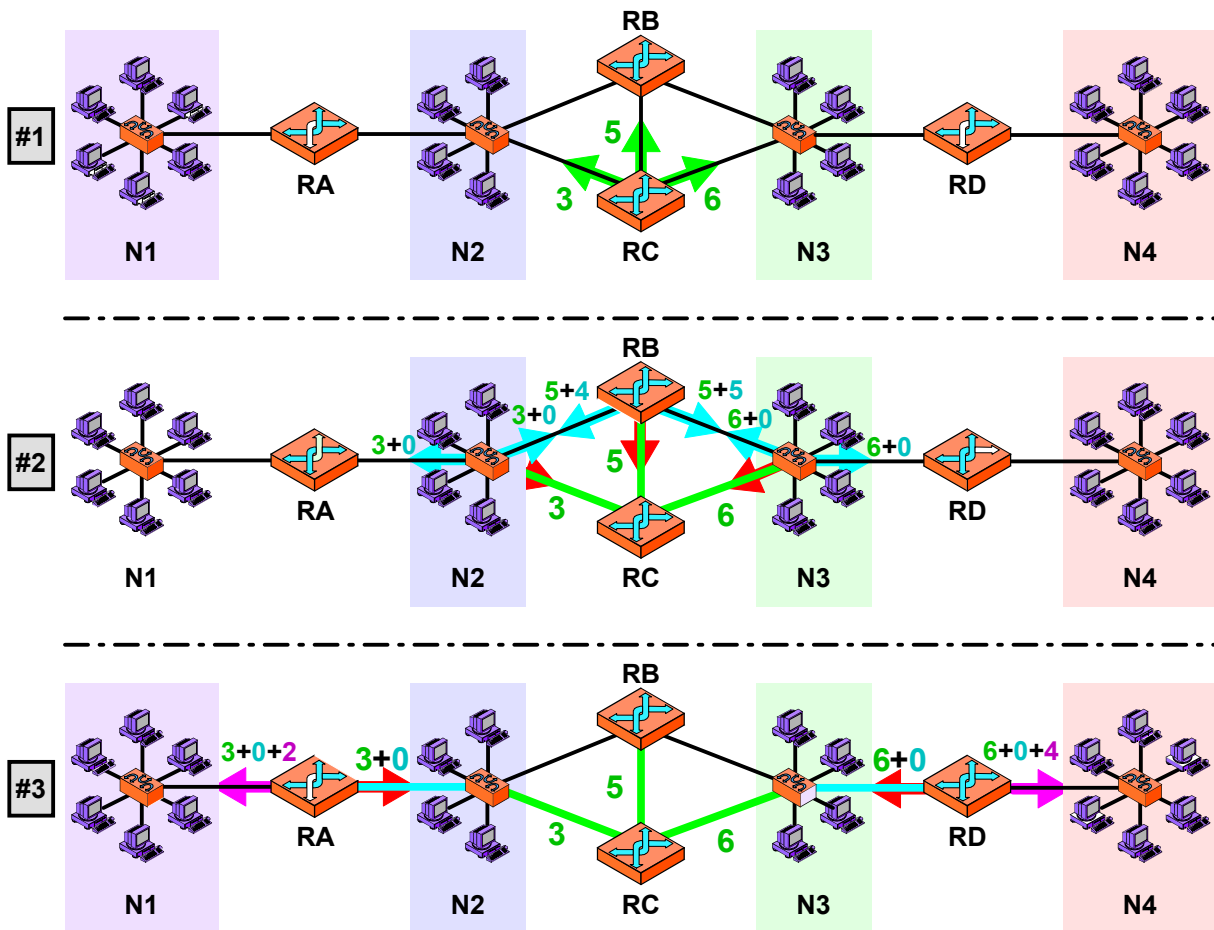

Figure 182: OSPF Route Determination Using The Shortest Path First Algorithm

This diagram shows graphically how a router, in this case *RC*, determines the best path to various networks. The arrows here represent not the transfer of data but rather the examination of various links from a router to other routers or networks. In panel #1, *RC* examines its LSDB and determines the cost for each of its directly-linked devices. In #2, the second level of the SPF tree is constructed by adding to those numbers the costs of all routers/networks that connect to the routers/networks found in panel #1. (The red arrows represent “looking back” in the direction we came from in the prior step, which we don’t pursue.) In #3 the process continues, resulting in the determination of a cost of 5 for *RC* to reach *N1* and 10 to reach *N4*.

- ☉ *N2* to *RA*, with a cost of 3.
- ☉ *N3* to *RD*, with a cost of 6.

Third Level

We continue the process by looking for devices that connect to the “weeded-out” devices we found on the second level (this time I am only showing the meaningful ones):

- ☉ ***RA***: *RA* connects to *N1*, with a cost of 2, total cost of 5.
- ☉ ***RD***: *RD* connects to *N4*, with a cost of 4, total cost of 10.

Shortest Path Tree and Route Calculation Results

In this simple example, we only need three levels to construct the tree for *RC* (we would need more for *RA* or *RD*, however.) The final results would be the tree in [Figure 183](#), and the routing information for *RC* to the four networks that is shown in [Table 126](#).

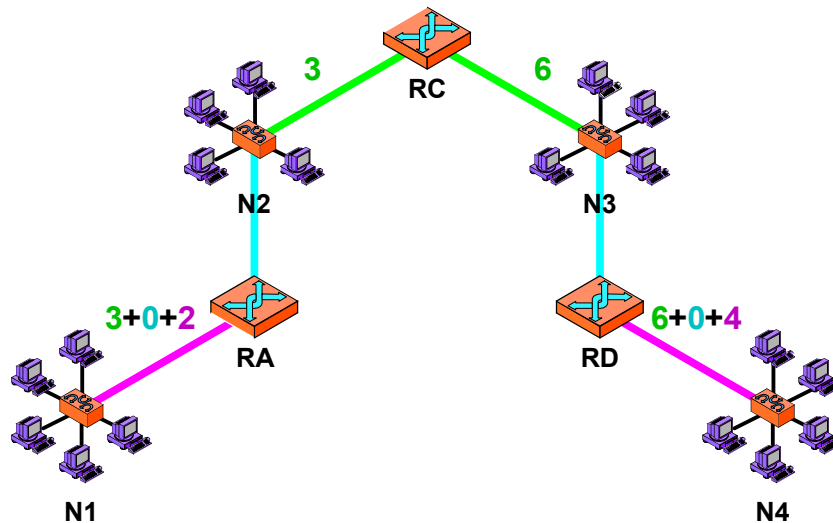

Figure 183: OSPF Calculated Shortest Path First Tree

This is a graphical representation of the SPF tree calculated in [Figure 182](#), showing only the final results of the calculation process.

Table 126: Example Calculated OSPF Routes

Destination Network	Cost	Next Hop
N1	5	RA
N2	3	(local)
N3	6	(local)
N4	10	RD

This of course is what you would expect in this very simple example. Note that there are no specific entries for other routers, since they are the “means to the end” of reaching networks. However, if one of the other routers were a boundary router that connected the AS to the outside world, there would be entries for the networks to which the boundary router connected, so *RC* knew to send traffic for those networks to that boundary router.

OSPF General Operation and Message Types

As a routing protocol, the main job of OSPF is to facilitate the exchange of routing information between routers. Each router in an OSPF autonomous system that runs OSPF software that is responsible for various tasks, such as setting timers to control certain activities that must occur on a regular basis, and the maintenance of important data structures,

such as the [link-state database \(LSDB\)](#). Most importantly, each OSPF router must both generate and respond to OSPF messages. It is this messaging system that allows important routing information to be shared within an AS or area, which makes it crucial to understanding how OSPF works. So, it's worth taking a look at the message types and how they are used.

OSPF Message Types

Unlike [RIP](#), OSPF does not send its information using the User Datagram Protocol (UDP). Instead, OSPF forms [IP datagrams](#) directly, packaging them using protocol number 89 for the IP *Protocol* field. OSPF defines five different message types, for various types of communication:

1. **Hello:** As the name suggests, these messages are used as a form of greeting, to allow a router to discover other adjacent routers on its local links and networks. The messages establish relationships between neighboring devices (called *adjacencies*) and communicate key parameters about how OSPF is to be used in the autonomous system or area.
2. **Database Description:** These messages contain descriptions of the topology of the AS or area. That is, they convey the contents of the link-state database for the autonomous system or area from one router to another. Communicating a large LSDB may require several messages to be sent; this is done by having the sending device designated as a *master* device and sending messages in sequence, with the slave (recipient of the LSDB information) responding with acknowledgements.
3. **Link State Request:** These messages are used by one router to request updated information about a portion of the LSDB from another router. The message specifies exactly which link(s) about which the requesting device wants more current information.
4. **Link State Update:** These messages contain updated information about the state of certain links on the LSDB. They are sent in response to a *Link State Request* message, and also broadcast or multicast by routers on a regular basis. Their contents are used to update the information in the LSDBs of routers that receive them.
5. **Link State Acknowledgment:** These messages provide reliability to the link-state exchange process, by explicitly acknowledging receipt of a *Link State Update* message.

OSPF Messaging and General Operation

The use of these messages is approximately as follows. When a router first starts up it will send a *Hello* message out to see if any neighboring routers are around running OSPF, and it will also send them out periodically to discover any new neighbors that may show up. When an adjacency is set up with a new router, *Database Description* messages will then be sent to initialize the router's LSDB.

Routers that have been initialized enter a steady state mode. They will each routinely "flood" their local networks with *Link State Update* messages, advertising the state of their links. They will also send out updates when they detect a change in topology that needs to

be communicated. They will of course receive *Link State Update* messages sent by other devices, and respond with *Link State Acknowledgments* accordingly. Routers may also request updates using *Link State Request* messages.



Key Concept: The operation of OSPF involves five message types. *Hello* messages are used to establish contact between routers, and *Database Description* messages to initialize a router's link-state database. Routine LSDB updates are sent using *Link State Update* messages, which are acknowledged using *Link State Acknowledgments*. A device may also request a specific update using a *Link State Request*.

When hierarchical topology is used, internal routers maintain a single LSDB and perform messaging only within an area. Area border routers have multiple LSDBs and perform messaging in more than one area. They, along with any other OSPF backbone routers, also exchange messaging information on the backbone, including summarized link-state information for the areas they border.

Again, all of this is highly simplified; the OSPF standard contains pages and pages of detailed rules and procedures governing the exact timing for sending and receiving messages.

OSPF Message Authentication

The OSPF standard specifies that all OSPF messages are authenticated for security. This is a bit misleading, however, since one of the authentication “methods” supported is “null authentication”—meaning no authentication is used. More security is provided by using the optional simple password authentication method, and the most security through the use of cryptographic authentication. These methods are described in Appendix D of RFC 2328.



Note: The *Hello* messages used in OSPF are also sometimes called the *Hello Protocol*. This is especially poor terminology because there is an actual routing protocol, described in the next section, called [the HELLO Protocol](#). The two protocols are not related. However, I suspect that the OSPF *Hello* messages may have been so named because they serve a similar purpose to the messages used in the independent HELLO protocol.

OSPF Message Formats

OSPF uses five different types of messages to communicate both link-state and general information between routers within an autonomous system or area. To help illustrate better how the OSPF messages are used, it's worth taking a quick look at the format used for each of these messages. Well, I guess I am being somewhat liberal in my use of the term “quick” here. 😊

OSPF Common Header Format

Naturally, each type of OSPF message includes a slightly different set of information—otherwise, they wouldn't be different message types! However, they all share a similar message structure, beginning with a shared 24-byte header. This common header allows certain standard information to be conveyed in a consistent manner, such as the number of the version of OSPF that generated the message. It also allows a device receiving an OSPF message to quickly determine which type of message it has received, so it knows whether or not it needs to bother examining the rest of the message. [Table 127](#) and [Figure 184](#) show the common OSPF header format.

Table 127: OSPF Common Header Format

Field Name	Size (bytes)	Description												
Version #	1	Version Number: Set to 2 for OSPF version 2.												
Type	1	<p>Type: Indicates the type of OSPF message:</p> <table border="1"> <thead> <tr> <th>Type Value</th> <th>OSPF Message Type</th> </tr> </thead> <tbody> <tr> <td>1</td> <td>Hello</td> </tr> <tr> <td>2</td> <td>Database Description</td> </tr> <tr> <td>3</td> <td>Link State Request</td> </tr> <tr> <td>4</td> <td>Link State Update</td> </tr> <tr> <td>5</td> <td>Link State Acknowledgment</td> </tr> </tbody> </table>	Type Value	OSPF Message Type	1	Hello	2	Database Description	3	Link State Request	4	Link State Update	5	Link State Acknowledgment
Type Value	OSPF Message Type													
1	Hello													
2	Database Description													
3	Link State Request													
4	Link State Update													
5	Link State Acknowledgment													
Packet Length	2	Packet Length: The length of the message, in bytes, including the 24 bytes of this header.												
Router ID	4	Router ID: The ID of the router that generated this message (generally its IP address on the interface over which the message was sent).												
Area ID	4	Area ID: An identification of the OSPF area to which this message belongs, when areas are used.												
Checksum	2	Checksum: A 16-bit checksum computed in a manner similar to a standard IP checksum . The entire message is included in the calculation except the <i>Authentication</i> field.												
AuType	2	<p>Authentication Type: Indicates the type of authentication used for this message:</p> <table border="1"> <thead> <tr> <th>Authentication Type Value</th> <th>OSPF Authentication Type</th> </tr> </thead> <tbody> <tr> <td>0</td> <td>No Authentication</td> </tr> <tr> <td>1</td> <td>Simple Password Authentication</td> </tr> <tr> <td>2</td> <td>Cryptographic Authentication</td> </tr> </tbody> </table>	Authentication Type Value	OSPF Authentication Type	0	No Authentication	1	Simple Password Authentication	2	Cryptographic Authentication				
Authentication Type Value	OSPF Authentication Type													
0	No Authentication													
1	Simple Password Authentication													
2	Cryptographic Authentication													
Authentication	8	Authentication: A 64-bit field used for authentication of the message, as needed.												

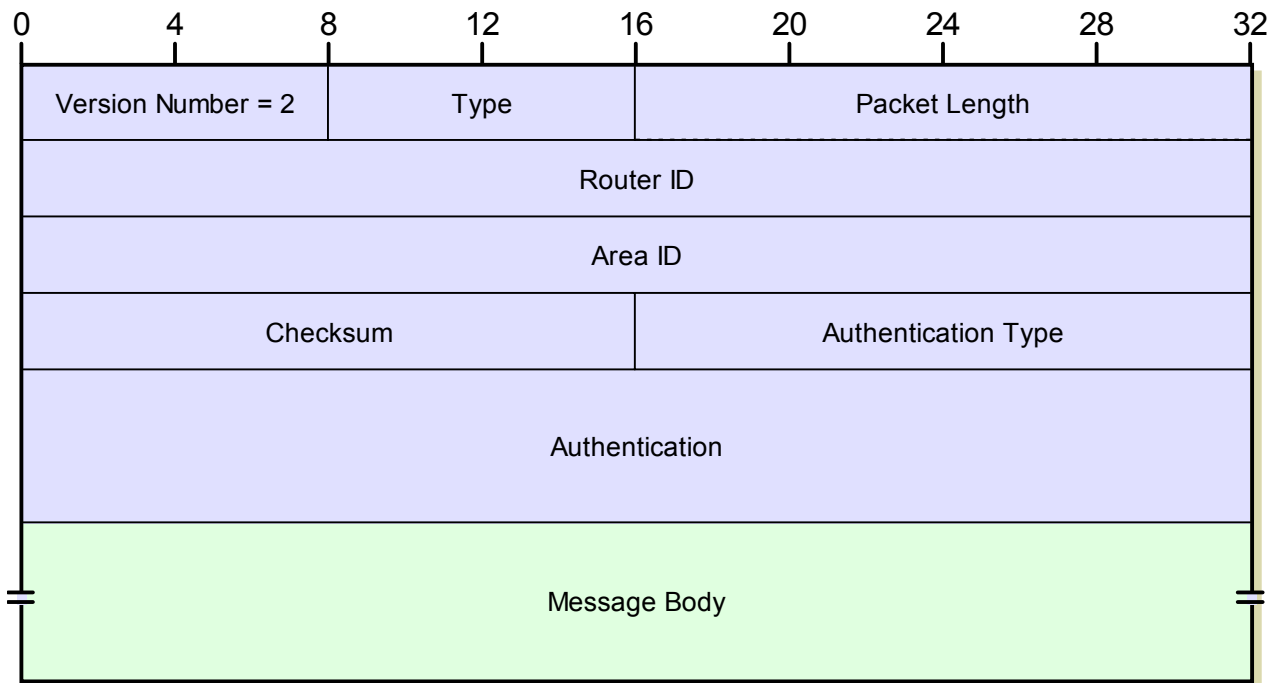

Figure 184: OSPF Common Header Format

Specific Message Formats

Following this header, the body of the message includes a variable number of fields is included that depends on the message type. Each of the message formats is described in detail in RFC 2328; since some are quite long I will describe their fields only briefly here.

Hello Message Format

These messages have a *Type* value of 1 in the header, and the field structure shown in [Table 128](#) and [Figure 185](#) in the body of the message.

Table 128: OSPF Hello Message Format (Page 1 of 2)

Field Name	Size (bytes)	Description
Network Mask	4	Network Mask: The subnet mask of the network the router is sending to.
Hello Interval	2	Hello Interval: The number of seconds this router waits between sending <i>Hello</i> messages.
Options	1	Options: Indicates which optional OSPF capabilities the router supports.
Rtr Pri	1	Router Priority: Indicates the router's priority, when electing a backup designated router.
Router Dead Interval	4	Router Dead Interval: The number of seconds a router can be "silent" before it is considered to have failed.

Table 128: OSPF Hello Message Format (Page 2 of 2)

Field Name	Size (bytes)	Description
Designated Router	4	Designated Router: The address of a router designated for certain special functions on some networks. Set to zeroes if there is no designated router.
Backup Designated Router	4	Backup Designated Router: The address of a backup designated router. Set to all zeroes if there is no backup designated router.
Neighbors	Multiple of 4	Neighbors: The addresses of each router from which this router has received Hello messages recently.

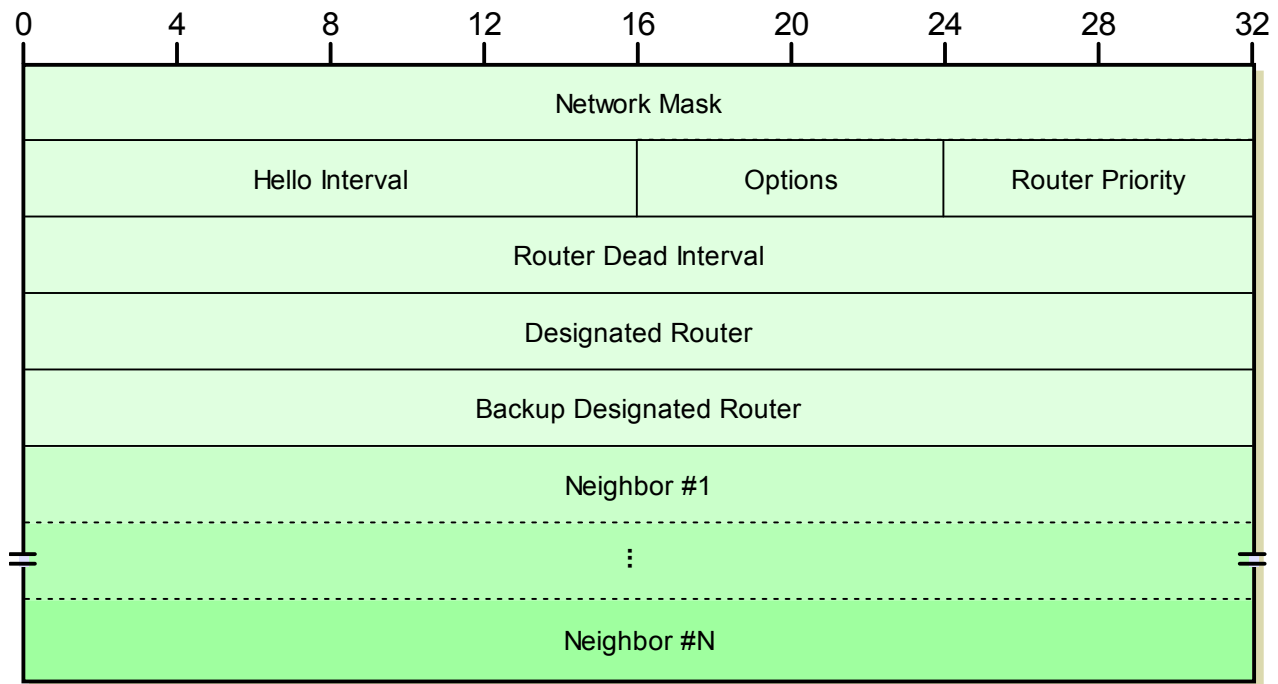

Figure 185: OSPF Hello Message Format

Database Description Message Format

These messages have a *Type* value of 2 in the header, and the body structure depicted in [Table 129](#) and [Figure 186](#).

Table 129: OSPF Database Description Message Format (Page 1 of 2)

Field Name	Size (bytes)	Description
Interface MTU	2	Interface MTU: The size of the largest IP message that can be sent on this router's interface without fragmentation.
Options	1	Options: Indicates which of several optional OSPF capabilities the router supports.

Table 129: OSPF Database Description Message Format (Page 2 of 2)

Field Name	Size (bytes)	Description															
Flags	1	<p>Flags: Special flags used to indicate information about the exchange of <i>Database Description</i> messages:</p> <table border="1"> <thead> <tr> <th>Subfield Name</th> <th>Size (bytes)</th> <th>Description</th> </tr> </thead> <tbody> <tr> <td>Reserved</td> <td>5/8 (5 bits)</td> <td>Reserved: Sent and received as zero.</td> </tr> <tr> <td>I</td> <td>1/8 (1 bit)</td> <td>I-Bit: Set to 1 to indicate that this is the first ("initial") in a sequence of <i>Database Description</i> messages.</td> </tr> <tr> <td>M</td> <td>1/8 (1 bit)</td> <td>M-Bit: Set to 1 to indicate that "more" <i>Database Description</i> messages follow this one.</td> </tr> <tr> <td>MS</td> <td>1/8 (1 bit)</td> <td>MS-Bit: Set to 1 if the router sending this message is the master in the communication, or 0 if it is the slave.</td> </tr> </tbody> </table>	Subfield Name	Size (bytes)	Description	Reserved	5/8 (5 bits)	Reserved: Sent and received as zero.	I	1/8 (1 bit)	I-Bit: Set to 1 to indicate that this is the first ("initial") in a sequence of <i>Database Description</i> messages.	M	1/8 (1 bit)	M-Bit: Set to 1 to indicate that "more" <i>Database Description</i> messages follow this one.	MS	1/8 (1 bit)	MS-Bit: Set to 1 if the router sending this message is the master in the communication, or 0 if it is the slave.
Subfield Name	Size (bytes)	Description															
Reserved	5/8 (5 bits)	Reserved: Sent and received as zero.															
I	1/8 (1 bit)	I-Bit: Set to 1 to indicate that this is the first ("initial") in a sequence of <i>Database Description</i> messages.															
M	1/8 (1 bit)	M-Bit: Set to 1 to indicate that "more" <i>Database Description</i> messages follow this one.															
MS	1/8 (1 bit)	MS-Bit: Set to 1 if the router sending this message is the master in the communication, or 0 if it is the slave.															
DD Sequence Number	4	DD Sequence Number: Used to number a sequence of <i>Database Description</i> messages so they are kept in order.															
LSA Headers	Variable	LSA Headers: Contains link-state advertisement headers, which carry information about the LSDB. See near the end of the topic for more information on LSAs.															

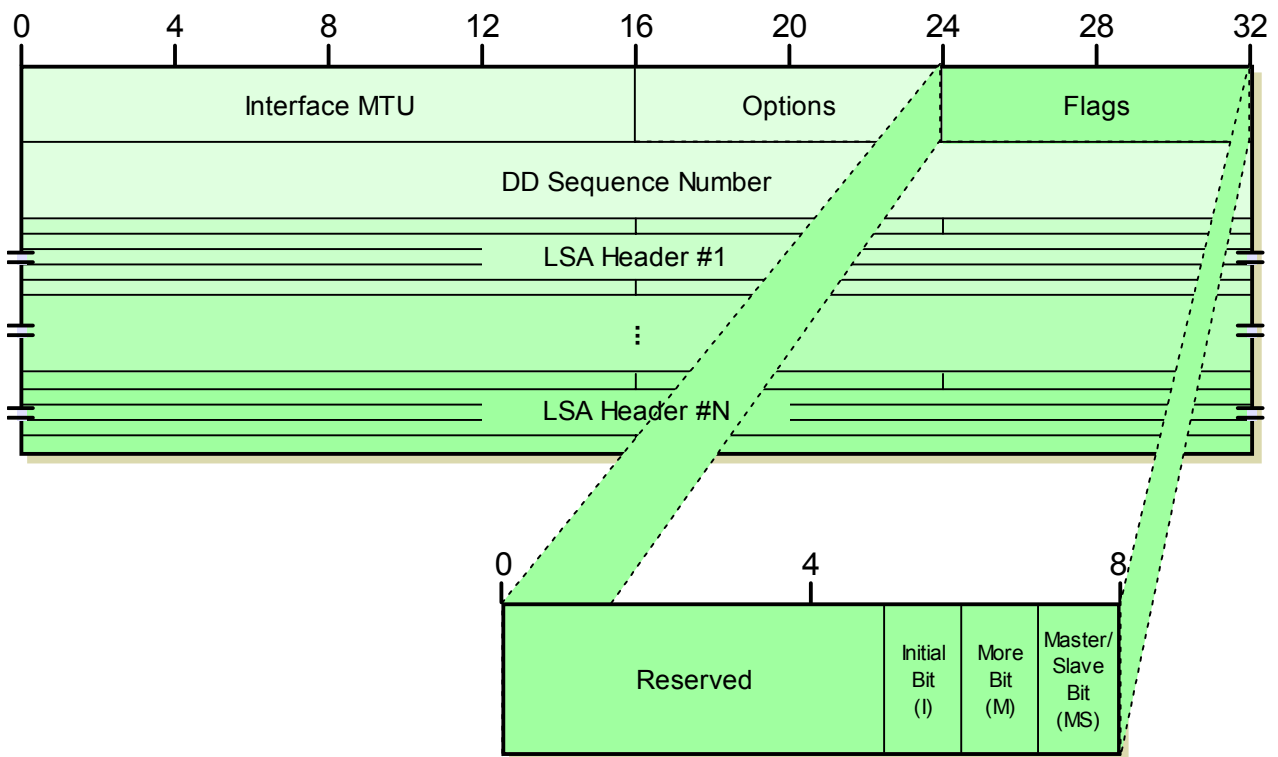

Figure 186: OSPF Database Description Message Format

Link State Request Message Format

These messages have a *Type* value of 3 in the header. Following the header comes one or more sets of three fields that each identify a [link state advertisement \(LSA\)](#) for which the router is requesting an update, as shown in [Figure 187](#). Each LSA identification has the format described in [Table 130](#).

Table 130: OSPF Link State Request Message Format

Field Name	Size (bytes)	Description
LS Type	4	Link State Type: The type of link state advertisement (LSA) being sought.
Link State ID	4	Link State ID: The identifier of the LSA, usually the IP address of either the router or network linked.
Advertising Router	4	Advertising Router: The ID of the router that created the LSA whose update is being sought.

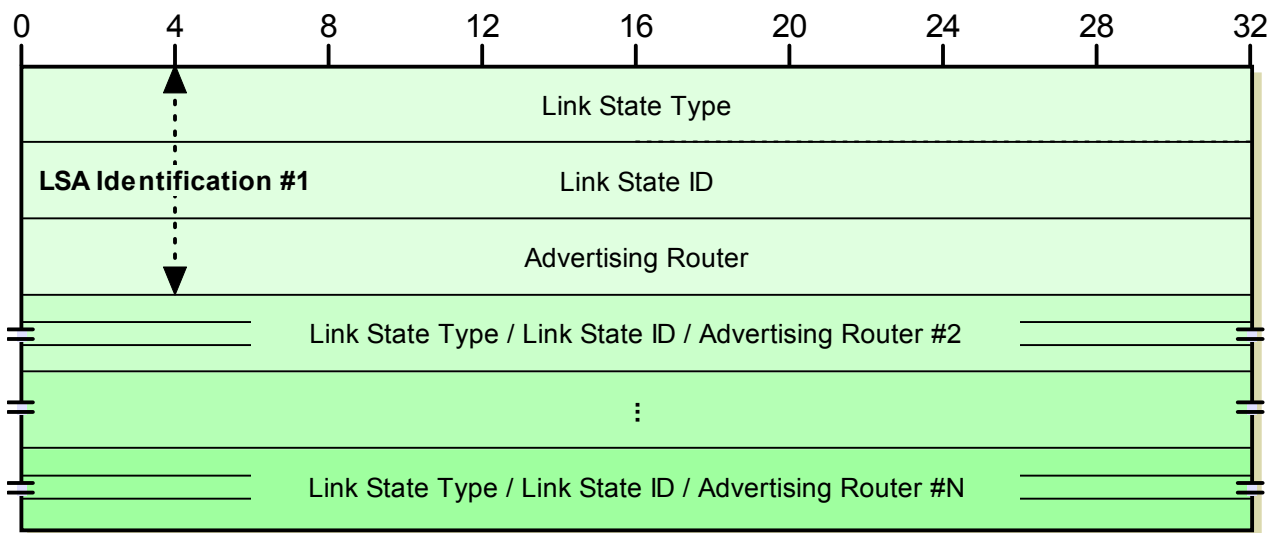

Figure 187: OSPF *Link State Request* Message Format

***Link State Update* Message Format**

These messages have a *Type* value of 4 in the header, and the fields illustrated in [Table 131](#) and [Figure 188](#).

Table 131: OSPF *Link State Update* Message Format

Field Name	Size (bytes)	Description
# LSAs	4	Number of LSAs: The number of link-state advertisements included in this message.
LSAs	Variable	LSAs: One or more link-state advertisements . See below for more details.

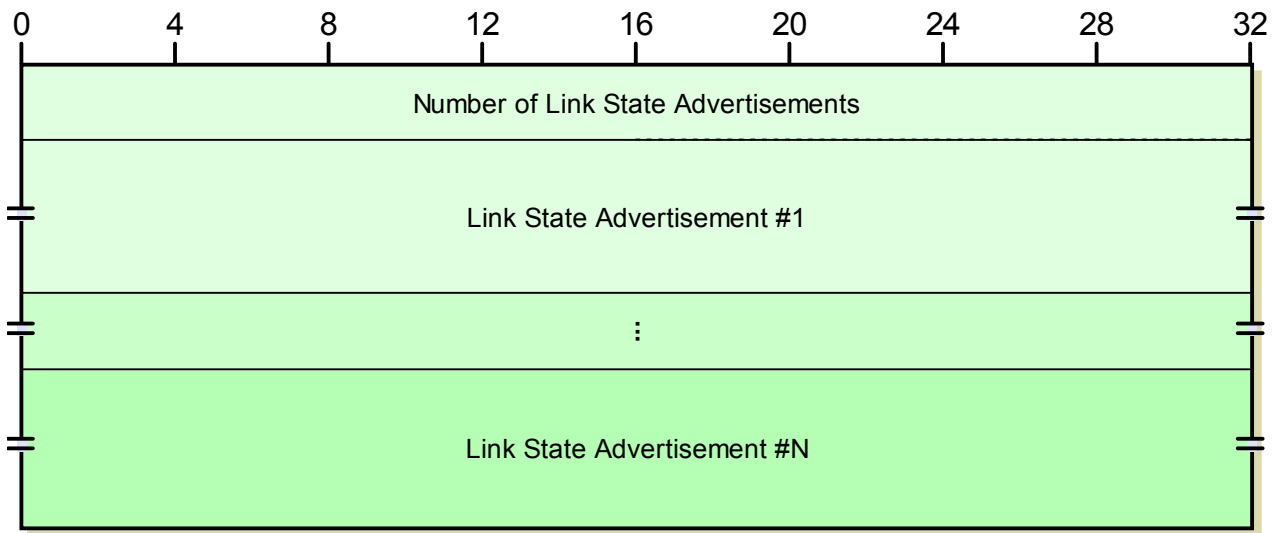

Figure 188: OSPF *Link State Update* Message Format

***Link State Acknowledgment* Message Format**

These messages have a *Type* value of 5 in the header. They then contain a list of LSA headers corresponding to the LSAs being acknowledged, as shown in [Table 132](#) and [Figure 189](#).

Table 132: OSPF *Link State Acknowledgment* Message Format

Field Name	Size (bytes)	Description
<i>LSA Headers</i>	Variable	<i>LSA Headers:</i> Contains link-state advertisement headers, to identify the LSAs acknowledged.

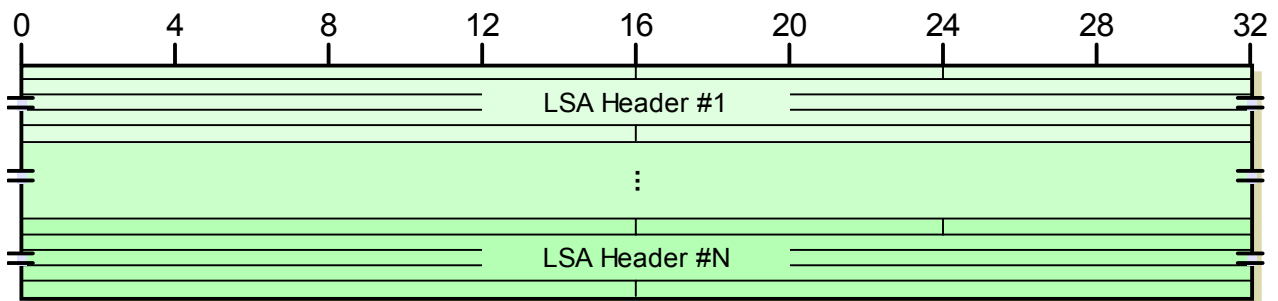

Figure 189: OSPF *Link State Acknowledgment* Message Format

Link State Advertisements (LSAs) and the LSA Header Format

As we saw above, several of the message types include *link state advertisements (LSAs)*, which are the fields that actually carry topological information about the LSDB. There are several types of LSAs, which are used to convey information about different types of links. Like the OSPF messages themselves, each LSA has a common header with 20 bytes, and then a number of additional fields that describe the link.

LSA Header

The LSA header contains sufficient information to identify the link. It uses the subfield structure in [Table 133](#) and [Figure 190](#).

Table 133: OSPF Link State Advertisement Header Format

Subfield Name	Size (bytes)	Description																		
LS Age	2	LS Age: The number of seconds elapsed since the LSA was created.																		
Options	1	Options: Indicates which of several optional OSPF capabilities the router supports.																		
LS Type	1	LS Type: Indicates the type of link this LSA describes:																		
		<table border="1"> <thead> <tr> <th>Value</th> <th>Link Type</th> <th>Description</th> </tr> </thead> <tbody> <tr> <td>1</td> <td>Router-LSA</td> <td>Link to a router</td> </tr> <tr> <td>2</td> <td>Network-LSA</td> <td>Link to a network</td> </tr> <tr> <td>3</td> <td>Summary-LSA (IP Network)</td> <td>When areas are used, summary information generated about a network.</td> </tr> <tr> <td>4</td> <td>Summary-LSA (ASBR)</td> <td>When areas are used, summary information about a link to an AS boundary router.</td> </tr> <tr> <td>5</td> <td>AS-External-LSA</td> <td>An external link outside the autonomous system.</td> </tr> </tbody> </table>	Value	Link Type	Description	1	Router-LSA	Link to a router	2	Network-LSA	Link to a network	3	Summary-LSA (IP Network)	When areas are used, summary information generated about a network.	4	Summary-LSA (ASBR)	When areas are used, summary information about a link to an AS boundary router.	5	AS-External-LSA	An external link outside the autonomous system.
		Value	Link Type	Description																
		1	Router-LSA	Link to a router																
		2	Network-LSA	Link to a network																
		3	Summary-LSA (IP Network)	When areas are used, summary information generated about a network.																
4	Summary-LSA (ASBR)	When areas are used, summary information about a link to an AS boundary router.																		
5	AS-External-LSA	An external link outside the autonomous system.																		
Link State ID	4	Link State ID: Identifies the link. This usually is the IP address of either the router or the network the link represents.																		
Advertising Router	4	Advertising Router: The ID of the router originating the LSA.																		
LS Sequence Number	4	LS Sequence Number: A sequence number used to detect old or duplicate LSAs.																		
LS Checksum	2	LS Checksum: A checksum of the LSA, for data corruption protection.																		
Length	2	Length: The length of the LSA, including the 20 bytes of the header.																		

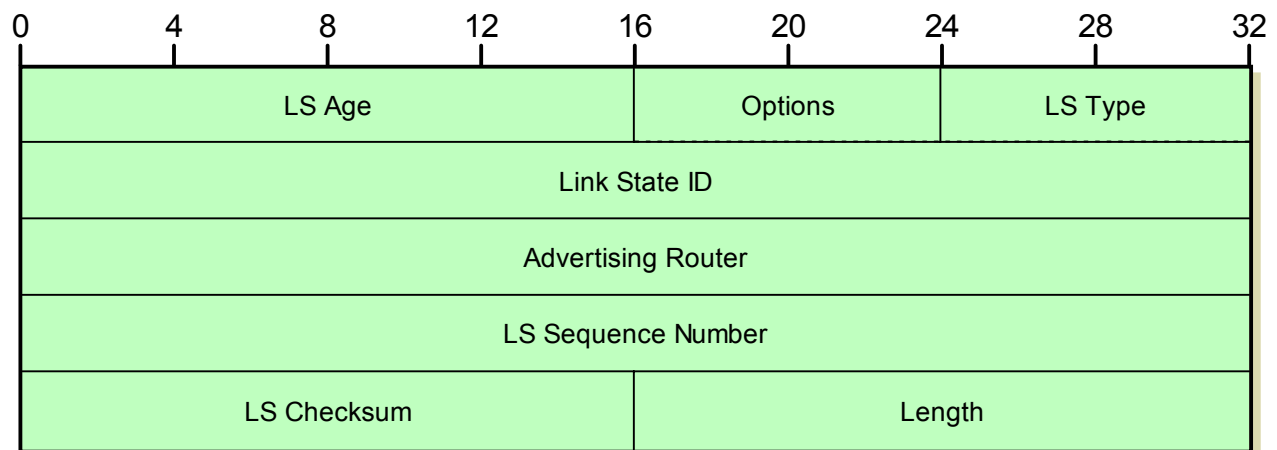

Figure 190: OSPF *Link State Advertisement* Header Format

LSA Body

Following the LSA header comes the body of the LSA, the specific fields of which depend on the value of the *LS Type* field. It would take several *more* pages to describe all these subfields, and I already probably went overboard in describing each message type, so I will refer you to Appendix A of RFC 2328 if you want all the details. By way of quick summary:

- ☉ For normal links to a router, the LSA includes an identification of the router and the metric to reach it, as well as details about the router such as whether it is a boundary or area border router.
- ☉ LSAs for networks include a subnet mask and information about other routers on the network.
- ☉ Summary LSAs include a metric and a summarized address, as well as a subnet mask.
- ☉ External LSAs include a number of additional fields to allow the external router to be communicated.



Other Interior Routing Protocols

The [Routing Information Protocol \(RIP\)](#) and [Open Shortest Path First \(OSPF\)](#) are the two most well-known interior routing protocols used in the TCP/IP suite, and for this reason I have described each in considerable detail. In addition to these, there are several other TCP/IP interior routing protocols that fall into one of two categories. Some are either protocols that are no longer used today but are interesting from a historical perspective, and others are proprietary alternates to RIP and OSPF that you may encounter today in the networking world but perhaps not as often.

In this section, I provide a brief description of four additional TCP/IP interior routing protocols. I begin with a look at two obsolete protocols that played an important role in the early Internet: the *Gateway-to-Gateway Protocol (GGP)* and the *HELLO Protocol*. I then describe two interior routing protocols developed by Cisco Systems, which are sometimes seen in the industry today as alternatives to RIP and OSPF: the *Interior Gateway Routing Protocol (IGRP)* and the *Enhanced Interior Gateway Routing Protocol (EIGRP)*.



Background Information: In some cases in this section, I make comparisons to RIP and OSPF as appropriate, to show where these protocols are similar to or differ from the “big two”. You may wish to have some familiarity with RIP and OSPF before continuing here.

TCP/IP Gateway-to-Gateway Protocol (GGP)

In [the overview topic on key routing protocol concepts](#), I described the evolution of TCP/IP routing architectures. The modern Internet is based on the concept of independent *autonomous systems (ASes)* that run interior routing protocols within them, and exterior routing protocols between them. The early Internet, however, was somewhat simpler; it consisted of a relatively small number of *core* routers that carried detailed information about the Internet as a whole, and *non-core* routers located around the core that knew only partial information.

These core routers used a special routing protocol to communicate called the *Gateway-To-Gateway Protocol (GGP)*. GGP was originally developed in the early 1980s by Bolt, Beranek and Newman (BBN) one of the pioneers of the Internet and TCP/IP. It was documented in RFC 823, *THE DARPA INTERNET GATEWAY*, published September 1982. This protocol is now obsolete, but it played an important role in the early Internet, and also introduced certain concepts that were used in routing protocols developed years later. This makes knowing a little bit about it worthwhile.

Overview of Operation

GGP is similar in general operation to the [Routing Information Protocol \(RIP\)](#) in that it uses a distance-vector algorithm to determine the best routes between devices. Like RIP, the metric is a simple hop count, so GGP will select a route with the shortest number of hops.

While we have seen in our discussion of RIP that hop count is not always the best metric of cost for a router, it was actually a pretty good method of route determination back then. This is because the early Internet used both computers and links that would be considered glacially slow by today's standards, making each hop fairly "expensive" compared to modern routing.

A router using GGP initially starts out in a *null state*, assuming that all links to other routers and local networks are down. It then tests the status of its local networks by seeing if it can send and receive messages on the network. Every 15 seconds, the router sends a GGP *Echo* message to each of its neighbors. If the neighbor receives the message, it responds with a GGP *Echo Reply* message. The router sending the *Echo* messages considers the neighbor up if it receives back replies to a certain percentage of messages, defaulting to 50%.



Note: These messages serve a similar function to [ICMPv4 Echo and Echo Reply messages](#), but are not the same.

Actual routing information is communicated by sending GGP *Routing Update* messages. These are similar in nature to *RIP Response* messages used in RIP. Each *Routing Update* message contains the information in the sending router's routing table, which specifies which networks the router can reach and at what cost (in hops) for each.

Each router receiving a *Routing Update* message knows that since it can reach the router that sent the update, it can also reach all of those router's reachable networks at the cost of an additional hop. It uses the information to update its own internal tables of destinations and metrics. It then sends out its own *Routing Update* on its own attached networks, to propagate the information learned from other routers on its own networks. This process continues until eventually, routes to all GGP routers spreads across the internetwork, [just as they do in RIP](#).

Propagation of Routing Table Information

One interesting difference between GGP and RIP is that in GGP, networks and costs aren't sent in pairs. Instead, a GGP router sends its routing table in groups. If it has three networks it can reach at a cost of 1 it sends those in a group with distance value 1, then if it has a few at a cost of 2 it sends those in a group with distance value 2, and so on. Another difference is that GGP *Routing Update* messages are acknowledged. Each *Routing Update* message is sent with a sequence number, which is used to ensure that out-of-date information is not propagated. If the *Routing Update* is received and has a new sequence number (indicating that it is recent information), the router processing it sends back a GGP *Acknowledgment* message back to the originator. If the sequence number indicates the message is stale, a *Negative Acknowledgment* is sent instead and the message discarded.

As a distance-vector algorithm using hop count as a metric, GGP shared most of the same pros and cons as RIP. It had simplicity on its side, but had [various problems](#) such as slow convergence and issues such as the “counting to infinity” problem. GGP was a much more rudimentary protocol than RIP, however, and did not include many of the [features included in RIP to handle such issues](#), such as split horizon. GGP was also limited to unsubnetted classful networks, due to its age.

Current Role in TCP/IP

When Internet architecture moved to the use of autonomous systems, GGP was obsoleted. While it was an important part of TCP/IP history, it is today not formally considered a part of the TCP/IP protocol suite.



Key Concept: The *Gateway-to-Gateway Protocol (GGP)* was used to communicate route information between core routers on the early Internet. It is a distance-vector protocol that operates in a manner very similar to RIP. Each router periodically sends out its routing table to neighboring routers, so each router can learn the cost, in hops, to reach every network in the autonomous system. GGP is now considered a historical protocol and is no longer part of TCP/IP.

The HELLO Protocol (HELLO)

The TCP/IP Internet as we know it today [evolved over the course of decades](#). It began as an experimental research project started by the United States *Defense Advanced Research Projects Agency (DARPA or ARPA)*, called the *ARPAnet*. The ARPAnet eventually grew through the addition of other networks, such as the important *NSFnet* developed by the *National Science Foundation (NSF)*. The NSFnet backbone grew over the course of many years and was instrumental to the eventual creation of the modern Internet.

The original NSFnet backbone consisted of six *Digital Equipment Corporation (DEC)*, absorbed by *Compaq* years ago) LSI-11 computers located across the United States. These computers ran special software colloquially called “fuzzball” that enabled them to function as routers. These “fuzzball routers” connected various networks to the NSFnet and the ARPAnet.

The six NSFnet routers worked as an autonomous system (AS) and like any AS, used an interior routing protocol to exchange routing information. The routing protocol used in these early routers was called the *HELLO* protocol. It was developed in the early 1980s and documented in RFC 891, *DCN Local-Network Protocols*, published December 1983. The name “HELLO” is capitalized, but is not an acronym; it simply refers to the word *hello*, since the protocol uses messages that are sort of analogous to the routers talking to each other.



Note: The [Open Shortest Path First \(OSPF\)](#) routing protocol has a message type called *Hello*. The use of these messages is sometimes referred to as “the *Hello Protocol*”. OSPF is not directly related to the HELLO protocol described in this section, other than both protocols being used for routing in an AS. It is possible OSPF borrowed the name *Hello* from the HELLO protocol but I can't find anything definitive on that subject.

Overview of Operation

The HELLO protocol uses a distance-vector algorithm, like the [Routing Information Protocol \(RIP\)](#) and the [Gateway-to-Gateway Protocol \(GGP\)](#). What's interesting about it, however, is that unlike RIP and GGP, HELLO does **not** use hop count as a metric. Instead, it attempts to select the best route by assessing network delays and choosing the path with the shortest delay.

One of the key jobs of routers using HELLO is to compute the time delay to send and receive datagrams to and from its neighbors. On a regular basis, routers exchange HELLO messages that contain clock and timestamp information. By comparing the clock value and timestamp in the message to its own clock using a special algorithm, a receiving device can compute an estimate for the amount of time it takes to send a datagram over the link.

Like RIP and GGP, *HELLO* messages also contain routing information in the form of a set of destinations that the sending router is able to reach and a metric for each. However in this case, the metric is an estimate of the round-trip delay cost for each destination. This information is added to the computed round-trip delay time for the link over which the message was received, and used to update the receiving router's own routing table.

This seems a bit confusing, but is really similar to the way a hop-count distance-vector protocol like RIP works. Router *A* using RIP receiving an *RIP Response* message from Router *B* knows it can reach every destination Router *B* can, but at a cost of one extra hop (the hop to go from Router *A* to Router *B*). Similarly, router *A* receiving a *HELLO* message from Router *B* knows it can reach every destination that Router *B* can, but at an additional approximate cost of the computed delay for the link between Router *A* and Router *B*.

Issues with Using Delay as a Metric

In theory, using delay calculations should result in more efficient route selection than simply using hop count, but at the cost of more complexity than a hop-count algorithm. This makes HELLO very interesting indeed, especially for a protocol that is over 20 years old. However, since the latency of a link is often unrelated to its bandwidth, using time delay as a link metric may lead to spurious results.

Furthermore, it is normal for the delay on any link to vary over time; in the case where there are two routes that are similar in cost, fluctuations in the delay for each route could result in rapid changes between routes (a phenomenon sometimes called *route flapping*). Adjustments are needed to the basic overview of the operation of the HELLO protocol above, to avoid these sorts of problems.

Current Role in TCP/IP

Like other early routing protocols, HELLO includes nothing fancy like authentication and so on; these features were not really needed in the early days of the Internet, when the inter-networks were small and easily controlled. As the Internet grew, HELLO was eventually replaced by newer routing protocols such as RIP. It is now considered a historical protocol (read: obsolete) and is no longer used.



Key Concept: The *HELLO Protocol* was used on very early routers on the precursors of the Internet to exchange routing information. It is a distance-vector protocol like RIP and GGP but differs in that it uses calculated delay as a metric instead of hop count. Like GGP, it is now considered a historical protocol and is no longer part of TCP/IP.

Interior Gateway Routing Protocol (IGRP)

If you have read a substantial portion of this Guide already, you have probably noticed that I greatly prefer universal, open standards to proprietary standards. (I explain the reasons why in [the Networking Fundamentals section on standards](#).) I am far from alone in this view, and in fact, it's no exaggeration to say that much of the success of TCP/IP and the Internet is tied to the fact that they were both developed using the open RFC process, and still are to this day.

That said, there are certain situations where a proprietary protocol can be of benefit, and can even achieve considerable success, if a minimum of two factors are true. First, there must be either a lack of a suitable open protocol, or a gap in the feature coverage of existing open protocols that creates an “opportunity” for a proprietary protocol to succeed. Second, the proprietary protocol must be either initiated or strongly supported by a “big player” in the industry, to help ensure that other companies will take notice and give the protocol a chance to become a standard.

This situation arose in the 1980s in the world of routing protocols. At that time, the most popular interior routing protocol was the Routing Information Protocol (RIP). As described in [the RIP section of this Guide](#), RIP does a basically good job, but has a number of [limitations and problems](#) that are inherent to the protocol and not easily resolved. In the mid-1980s, open alternatives like [OSPF](#) did not yet exist; even if it had, OSPF is much more complex than RIP and therefore sometimes not a good alternative.

Cisco Systems, definitely one of the “big names” in networking and especially internet-working and routing, decided to develop a new routing protocol that would be similar to RIP but would provide greater functionality and solve some of RIP's inherent problems: the *Interior Gateway Routing Protocol (IGRP)*. IGRP—which conveniently uses both the words “gateway” and “routing” in its name to convey the equivalence of the two words in internet-working standards—was designed specifically to be a replacement for RIP. It is similar in many ways, and keeps RIP's simplicity, one of its key strengths. At the same time, IGRP overcomes two key limitations of RIP: the use of only hop count as a routing metric, and the hop count limit of 15.

Overview of Operation

Like RIP, IGRP is a distance-vector routing protocol designed for use with an autonomous system, and thus uses [the same basic mechanism for route determination](#). Each router routinely sends out on each local network to which it is attached a message containing a copy of its routing table. This message contains pairs of reachable networks and costs (metrics) to reach each network. A router receiving this message knows it can reach all the networks in the message as long as it can reach the router that sent the message. It computes the cost to reach those networks by adding to their costs, the cost to reach the router that sent the message. The routers update their tables accordingly, and send this information out in their next routine update. Eventually, each router in the autonomous system has information about the cost to reach each network in it.

Features and Capabilities

An important difference between RIP and IGRP, however, is that where RIP only allows the cost to reach a network to be expressed in terms of hop count, IGRP provides a much more sophisticated metric. In IGRP, the overall cost to reach a network is computed based on several individual metrics, including internetwork delay, bandwidth, reliability and load. The calculation of cost can be customized by an administrator, who can set relative weightings to the component metrics to reflect the priorities of that autonomous system. So, if a particular administrator feels route cost would be best minimized by emphasizing reliability over bandwidth, he or she can do this. Such a system provides tremendous flexibility over the rigid hop-count system of RIP. Unlike RIP, IGRP also does not have any inherent limit of 15 hops between networks.

To this basic algorithm, IGRP adds a feature called *multipath routing*. This allows multiple paths between routes to be used automatically, with traffic shared between them. The traffic can either be shared evenly, or apportioned unevenly based on the relative cost metric of each path. This provides improved performance and again, flexibility.

Since IGRP is a distance-vector protocol like RIP, it shares many of RIP's algorithmic “issues”. Unsurprisingly, then, IGRP must incorporate many of [the same stability features as RIP](#), including the use of split horizon, split horizon with poisoned reverse (in certain circumstances) and the employment of hold-down timers. Like RIP, IGRP also uses timers to control how often updates are sent, how long routers are “held down”, and how long routes are held in the routing table before being expired.

Cisco originally developed IGRP for IP networks, and since IP is predominant in the industry, this is where it is most often seen. IGRP is not specific to IP, however, and can be used with other internetworking protocols if implemented for them. [As we will see in the next topic](#), Cisco also used IGRP as the basis for an improved routing protocol called EIGRP, developed several years after the original.



Key Concept: In the 1980s, Cisco Systems created the Interior Gateway Routing Protocol (IGRP) as an improvement over the industry standard protocol RIP. IGRP is a distance-vector protocol like RIP and similar to it in many ways, but includes several enhancements. Amongst the most important of these is an elimination of the 15 hop limit between routers, and the ability to use metrics other than hop count to determine optimal routes.

Enhanced Interior Gateway Routing Protocol (EIGRP)

Cisco Systems, a leader in the world of internetworking and routing technology, developed the [Interior Gateway Routing Protocol \(IGRP\)](#) in the mid-1980s as an alternative protocol to [RIP](#) for use in TCP/IP autonomous systems. IGRP represented a substantial improvement over RIP, but like any successful company, Cisco was not content to rest on its laurels. Cisco knew that IGRP had significant room for improvement, so they set to work on creating a better version of IGRP in the early 1990s. The result was the *Enhanced Interior Gateway Routing Protocol (EIGRP)*.

Comparing IGRP and EIGRP

Compared to the original protocol, EIGRP is more of an evolution than a revolution. EIGRP is still a [distance-vector protocol](#), but is more sophisticated than other distance-vector protocols like IGRP or RIP, and includes certain features that are more often associated with link-state routing protocols like [OSPF](#) than distance-vector algorithms. Also, since Cisco realized many of the organizations deciding to use EIGRP would be migrating to it from IGRP, they took special steps to maximize compatibility between the two.

The chief differences between IGRP and EIGRP are not in what they do, but how they do it. EIGRP changes the way that routes are calculated, in an effort to improve efficiency and the speed of route convergence (agreement on routes between different routers in the internetwork). EIGRP is based on a new route calculation algorithm called the *Diffusing Update Algorithm (DUAL)*, developed at a company called *SRI International* by Dr. J. J. Garcia-Luna-Aceves.

EIGRP's DUAL Route Calculation Algorithm

DUAL differs from a typical distance-vector algorithm primarily in that it maintains more topology information about the internetwork than that used by protocols like RIP or IGRP. It uses this information to automatically select least-cost, loop-free routes between networks. EIGRP uses a metric that combines an assessment of the bandwidth of a link and the total

delay to send over the link. (Other metrics are configurable as well, though not recommended.) When a neighboring router sends changed metric information, routes are recalculated and updates sent as needed. DUAL will query neighboring routers for reachability information if needed (for example, if an existing route fails).

This “as needed” aspect of operation highlights an important way that EIGRP improves performance over IGRP. EIGRP does not send routine route updates, only partial updates as required, reducing the amount of traffic generated between routers. Furthermore, these updates are designed so that only the routers that need the updated information receive them.

Other Features of EIGRP

In order to build the tables of information it needs to calculate routes, EIGRP requires that each router make and maintain contact with other routers on their local networks. To facilitate this, EIGRP incorporates a *neighbor discovery/recovery* process. This system involves the exchange of small *Hello* messages that let routers discover which other routers on the local network, and to periodically check their reachability. This is very similar to the use of the identically-named *Hello* messages in OSPF, and has a low impact on bandwidth use because the messages are small and infrequently sent.

Some of the features in IGRP carry through to its successor, such as the use of split horizon with poisoned reverse for improved stability. In addition to the basic improvements of efficiency and route convergence that accrue from the algorithm itself, EIGRP includes some other features. These include support for [variable length subnet masks \(VLSM\)](#) and support for multiple network-layer protocols. This means that EIGRP could be configured to function on a network running IP as well as another layer three protocol.



Key Concept: Developed in the 1990s, the *Enhanced Interior Gateway Routing Protocol (EIGRP)* is an improved version of Cisco’s IGRP. It is similar to IGRP in many respects, but uses a more sophisticated route calculation method called the *Diffusing Update Algorithm (DUAL)*. EIGRP also includes several features that make it more intelligent in how it computes routes, borrowing concepts from link-state routing protocols, and using more efficient partial updates rather than sending out entire routing tables.



TCP/IP Exterior Gateway/Routing Protocols (BGP and EGP)

For ease of administration, [routers on large internetworks are grouped into autonomous systems \(ASes\)](#) that are independently controlled by different organizations and companies. [Interior routing protocols](#) such as RIP and OSPF are used to communicate routing information between routers within an autonomous system. Obviously, if interior routing protocols are used within ASes, we need another set of routing protocols to send that information **between** ASes. These are called *exterior routing protocols*.

The entire point of autonomous system architecture is conveyed in the meaning of the first word in that phrase: *autonomous*. The details of what happens within an AS are hidden from other ASes, which allows the administrator of an AS to have the independence to control how he or she runs it, including the selection of one or more from a variety of different interior routing protocols. In contrast, to reliably connect ASes together, it is essential that each one be running the same exterior routing protocol, or the result would be something akin to the Tower of Babel. The result of this is that in TCP/IP there is generally only one exterior routing protocol in widespread use at a given time.

In this section I describe two different TCP/IP exterior routing protocols. The first is the *Border Gateway Protocol (BGP)*, the one used in modern TCP/IP. BGP is very important since it is used on the current Internet and other larger internetworks, so it is covered in considerable detail. The second is the *Exterior Gateway Protocol (EGP)*. This is an obsolete protocol that was used for communication between non-core routers and the router core in the early Internet, and is described briefly for both completeness and historical interest.



Background Information: I am assuming in this section that you are already at least somewhat familiar with interior routing protocols, at least to the extent of understanding what they do in basic terms. If you have not yet read up on RIP, the most common interior routing protocol, [you may wish to skim that section](#). At the very least, make sure you are familiar with [the overview of routing protocol architectures](#).

TCP/IP Border Gateway Protocol (BGP/BGP-4)

Modern TCP/IP internetworks are comprised of autonomous systems (ASes) that are run independently. Each may use an [interior routing protocol](#) such as RIP, OSPF, IGRP or EIGRP to select routes between networks within the AS. To form larger internetworks, and especially the “mother of all internetworks”, the Internet, these autonomous systems must be connected together. This requires use of a consistent exterior routing protocol that all ASes can agree upon, and in today's TCP/IP that protocol is the *Border Gateway Protocol (BGP)*.

In this section I describe the characteristics, general operation and detailed operation of the Border Gateway Protocol (BGP). The discussion is divided into two subsections. The first provides an overview and general look at the operation of BGP, including a discussion of key concepts such as topology, neighbor relationships, route determination and general messaging. The second gives a more detailed analysis of the different message types and how they are used, and describes the format of each message as well.

BGP is another in the rather large group of protocols and technologies that is so complex it would take dozens of topics to do justice. Therefore, I include here my somewhat standard disclaimer that you will find in this section only a relatively high-level look at BGP. You will need to refer to the BGP standards ([described in the topic on BGP standards and versions](#)) if you need more details.



Note: The current version of BGP is version 4, also called *BGP-4*. This is the only version widely used today, so unless otherwise indicated, assume BGP-4 wherever you see “BGP”.

BGP Fundamentals and General Operation

If you were to ask the average Internet user, or even that typical network administrator, to make a list of the ten most important TCP/IP protocols, it's probable that BGP wouldn't often show up. Routing protocols are “worker bees” of the TCP/IP suite and just not very exciting. The reality, however, is that BGP is a critically important protocol to the operation of larger internetworks and the Internet itself. It is the “glue” that binds smaller internetworks (autonomous systems) together, and it ensures that every organization is able to share routing information. It is this function that lets us take disparate networks and internetworks and find efficient routes from any host to any other host, regardless of location.

In this section I begin our look at the very important BGP protocol by covering its basic concepts and general operation. I start, as usual, with an overview of the protocol and discussion of its history, standards and versions, including a discussion of its key features and characteristics. I then cover basic operational concepts, including topology, the notion of BGP *speakers* and neighbor relationships. I discuss BGP traffic types and how policies can be used to control traffic flows on the internetwork. I explain how BGP routers store and advertise routes, and the function of Routing Information Bases (RIBs). I describe the basic algorithm used by BGP and how path attributes describe routes. I then provide a summary of how the BGP route selection process operates. I conclude with a general description of BGP's operation and its high-level use of various messages.

BGP Overview, History, Standards and Versions

As I describe briefly in [the overview of routing protocol concepts](#), the way that routers were connected in the early Internet was quite different than it is today. The early Internet had a set of centralized routers functioning like a “core” autonomous system. These routers used the [Gateway-to-Gateway Protocol](#) for communication between them within the AS, and the aptly-named [Exterior Gateway Protocol \(EGP\)](#) to talk to routers outside the core.

Motivation and Development of BGP

When the Internet grew and moved to autonomous system (AS) architecture, EGP was still able to function as the exterior routing protocol for the Internet. However, as the number of autonomous systems in an internetwork grows, the importance of communication between them grows as well. EGP was functional but had several weaknesses that became more problematic as the Internet grew in size. It was necessary to define a new exterior routing protocol that would provide enhanced capabilities for use on the growing Internet.

In June 1989, the first version of this new routing protocol was formalized, with the publishing of RFC 1105, [A Border Gateway Protocol \(BGP\)](#). This initial version of the BGP standard defined most of the concepts behind the protocol, as well as key fundamentals such as messaging, message formats and how devices operate in general terms. It established BGP as the Internet's exterior routing protocol of the future.

BGP Evolution, Versions and Defining Standards

Due to the importance of a protocol that spans the Internet, work continued on BGP for many years after the initial standard was published. The developers of BGP had to correct problems with the initial protocol, refine BGP's operation, improve efficiency, and add features. It was also necessary to make adjustments to allow BGP to keep pace with other changes in the TCP/IP protocol suite, such as the invention of [classless addressing and routing](#).

The result of this ongoing work is that BGP has evolved through several versions and standards. These are sometimes called *BGP-N* where *N* is the version number. [Table 134](#) shows the history of BGP standards, providing the RFC numbers and names and a brief summary of the changes made in each version.

Table 134: Border Gateway Protocol (BGP) Versions and Defining Standards

RFC Number	Date	Name	BGP Version	Description
1105	June 1989	<i><u>A Border Gateway Protocol (BGP)</u></i>	BGP-1	Initial definition of the BGP protocol.
1163	June 1990	<i><u>A Border Gateway Protocol (BGP)</u></i>	BGP-2	This version cleaned up several issues with BGP-1, and refined the meaning and use of several of the message types. It also added the important concept of path attributes, which communicate information about routes. BGP-1 was designed around the notion of a directional topology, with certain routers being “up”, “down” or “horizontal” relative to each other; BGP-2 removed this concept, making BGP better suited to an arbitrary AS topology. Note that the RFC title is not a typo; they didn't put “version 2” in the title.
1267	October 1991	<i><u>Border Gateway Protocol 3 (BGP-3)</u></i>	BGP-3	This version optimized and simplified route information exchange, adding an identification capability to the messages used to establish BGP communications, and incorporating several other improvements and corrections. (They left the “A” off the title of this one for some reason. ☺)
1654	July 1994	<i><u>A Border Gateway Protocol 4 (BGP-4)</u></i>	BGP-4	Initial standard for BGP-4, revised in RFC 1771. See just below.
1771	March 1995	<i><u>A Border Gateway Protocol 4 (BGP-4)</u></i>	BGP-4	Current standard for BGP-4. The primary change in BGP-4 is support for Classless Inter-Domain Routing (CIDR) . The protocol was changed to allow prefixes to be specified that represent a set of aggregated networks. Other minor improvements were also made to the protocol.

As you might imagine, changing the version of a protocol like BGP is not an easy undertaking. Any modification of the protocol would require the coordination of many different organizations. The larger the Internet grows, the more difficult this would be. As a result, despite frequent version changes in the early 1990s, BGP-4 remains today the current version of the standard, and is the one that is widely used. Unless otherwise specified, any mention of BGP in this Guide refers to BGP-4.

BGP Supplementary Standards

Supplementing RFC 1771 are three other consecutively-numbered RFCs published simultaneously with it, which provide supporting information about BGP's functions and use, as shown in [Table 135](#).

Table 135: Additional Defining Standards For BGP-4

RFC Number	Name	Description
1772	<i><u>Application of the Border Gateway Protocol in the Internet</u></i>	Provides additional conceptual information on the operation of BGP and how it is applied to and used on the Internet. This document is sometimes considered a companion of RFC 1771 with the pair defining BGP-4.
1773	<i><u>Experience with the BGP-4 Protocol</u></i>	Describes the experiences of those testing and using BGP-4, and provides information that justified its acceptance as a standard.
1774	<i><u>BGP-4 Protocol Analysis</u></i>	Provides more detailed technical information about the operation of the BGP-4 protocol.

Overview of BGP Functions and Features

If I were to summarize the job of BGP in one phrase, it would be “to exchange network *reachability information* between autonomous systems and from this information determine routes to networks”. In a typical internetwork (and in the Internet) each autonomous system designates one or more routers that run BGP software. BGP routers in each autonomous system are linked to those in one or more other autonomous systems. Each BGP stores information about networks and the routes to them in a set of *Routing Information Bases (RIBs)*. This route information is exchanged between BGP routers, and propagated throughout the entire internetwork, allowing each AS to find paths to each other AS, and thereby enabling routing across the entire internetwork.



Key Concept: The exterior routing protocol used in modern TCP/IP internetworks is the Border Gateway Protocol (BGP). Initially developed in the late 1980s as a successor to EGP, BGP has been revised many times; the current version is 4, so BGP is also commonly called *BGP-4*. BGP's primary function is the exchange of network reachability information between autonomous systems to allow each AS on an internetwork to send messages efficiently to every other one.

BGP supports an arbitrary topology of ASes, meaning they can be connected in any manner. An AS must have a minimum of one router running BGP, but can have more than one. It is also possible to use BGP to communicate between BGP routers within the same autonomous system.

BGP uses a fairly complex system for route determination. The protocol goes beyond the limited notion of considering only the next hop to a network the way [distance-vector algorithms like RIP](#) function. Instead, the BGP router stores more complete information about the path (sequence of autonomous systems) from itself to a network. Special *path attributes* describe the characteristics of paths, and are used in the process of route selection. Because of its storage of not just next-hop but path information, BGP is sometimes called a *path vector* protocol.

BGP chooses routes using a deterministic algorithm that assess path attributes and chooses an efficient route while avoiding router loops and other problem conditions. The selection of routes by a BGP router can also be controlled through a set of BGP *policies* that specify, for example, whether an AS is willing to carry traffic from other ASes or not. However, BGP cannot guarantee the most efficient route to any destination, because it cannot know what happens within each AS and therefore what the cost is to traverse each AS.

BGP's operation is based on the exchange of messages that perform different functions. BGP routers use *Open* messages to contact neighboring routers and establish BGP sessions. They exchange *Update* messages to communicate information about reachable networks, sending only partial information as needed. They also use *Keepalive* and *Notification* messages to maintain sessions and inform peers of error conditions. The use of these messages is summarized in [the topic on BGP general operation](#), with details (including message formats) in [the section on detailed operation](#).

BGP uses [TCP](#) as a reliable transport protocol, so it can take advantage of the many connection setup and maintenance features of that protocol. This also means that BGP doesn't need to worry about issues such as message sequencing, acknowledgements, or lost transmissions. Since unauthorized BGP messages could wreak havoc with the operation of the Internet, BGP includes an authentication scheme for security.



Key Concept: BGP supports an arbitrary topology of autonomous systems. Each autonomous system using BGP assigns one or more routers to implement the protocol. These devices then exchange messages to establish contact with each other and share information about routes through the internetwork using TCP. BGP employs a sophisticated *path vector* route calculation algorithm that determines routes from path attributes that describe how different networks can be reached.



Note: BGP maintains backwards compatibility with the older exterior routing protocol, [EGP](#).

BGP Topology, Speakers, Border Routers and Neighbor Relationships (Internal and External Peers)

In my [overview of BGP](#), I boiled down the function of the Border Gateway Protocol (BGP) into this summary: the exchange of network reachability information between autonomous systems (ASes) of routers and networks, and the determination of routes from this information. The actual method that BGP uses to accomplish this, however, is fairly complex. To help us understand how BGP works, we should start by looking at the structure of BGP internetworks, and also a discussion of key BGP terms.

BGP Topology and Speakers

One of the most important characteristics of BGP is its *flexibility*. The protocol can connect together any internetwork of autonomous systems using an arbitrary topology. The only requirement is that each AS have at least one router that is able to run BGP and that this router connect to at least one other AS's BGP router. Beyond that, “the sky's the limit,” as they say. BGP can handle a set of ASes connected in a full mesh topology (each AS to each other AS), a partial mesh, a chain of ASes linked one to the next, or any other configuration. It also handles changes to topology that may occur over time.

Another important assumption that BGP makes is that it doesn't know anything about what happens within the AS. This is of course an important prerequisite to the notion of an AS being *autonomous*—it has its own internal topology and uses its own choice of routing protocols to determine routes. BGP only takes the information conveyed to it from the AS and shares it with other ASes.

Creating a BGP internetwork begins with the designation of certain routers in each AS as ones that will run the protocol. In BGP parlance, these are called BGP *speakers*, since they speak the BGP “language”. A protocol can reasonably be called a language, but I have not encountered this notion of a “speaker” in any other protocol, so it's somewhat interesting terminology.

BGP Router Roles and Neighbors

An autonomous system can contain many routers which are connected in an arbitrary topology. We can draw a distinction between routers in an AS that are connected only to other routers within the AS, versus those that connect to other ASes. Routers in the former group are usually called *internal routers*, while the latter group are called *border routers* in BGP, and similar names in other protocols. For example, in OSPF they are called *boundary routers*.

Of course, the notion of a *border* is the basis for the name of the BGP protocol itself. To actually create the BGP internetwork, the BGP speakers bordering each AS are physically connected to one or more BGP speakers in other ASes, in whatever topology the internetwork designer decrees. When a BGP speaker in one AS is linked to a BGP speaker in another AS, they are deemed *neighbors*. The direct connection between them allows them to exchange information about the ASes of which they are a part.

BGP Internal and External Peers

Most BGP speakers will be connected to more than one other speaker. This provides both greater efficiency in the form of more direct paths to different networks, and also redundancy to allow the internetwork to cope with either device or connection failures. It is possible (and in many cases, likely) for a BGP speaker to have neighbor relationships with other BGP speakers both within its own AS and outside its AS. A neighbor within the AS is called an *internal peer*, while a neighbor outside the AS is an *external peer*. BGP between internal peers is sometimes called *Internal BGP (IBGP)* while use of the protocol between external peers is *External BGP (EBGP)*. The two are similar, but differ in certain areas, especially [path attributes and route selection](#). You can see an example of BGP topology and the designation of internal and external peers in [Figure 191](#).



Key Concept: Each router configured to use BGP is called a BGP *speaker*; these devices exchange route information using the BGP messaging system. Routers that only connect to other routers in the same autonomous system are called *internal routers*, while those that connect to other ASes are *border routers*. Neighboring BGP speakers in the same AS are called *internal peers*, while those in different ASes are *external peers*.

A peer connection between BGP speakers can be either a direct link using some form of layer two technology, or an indirect link using TCP. This allows the BGP speakers to establish BGP sessions and then exchange routing information, using [the messaging system we will see later in this section](#). Of course, it also is the means by which actual “end user” traffic moves between autonomous systems. External peers are normally connected directly, while internal peers are often linked indirectly.

In [the next topic](#) we will see that the method in which ASes are connected has an important impact on the overall function of the internetwork and how traffic is carried on it.

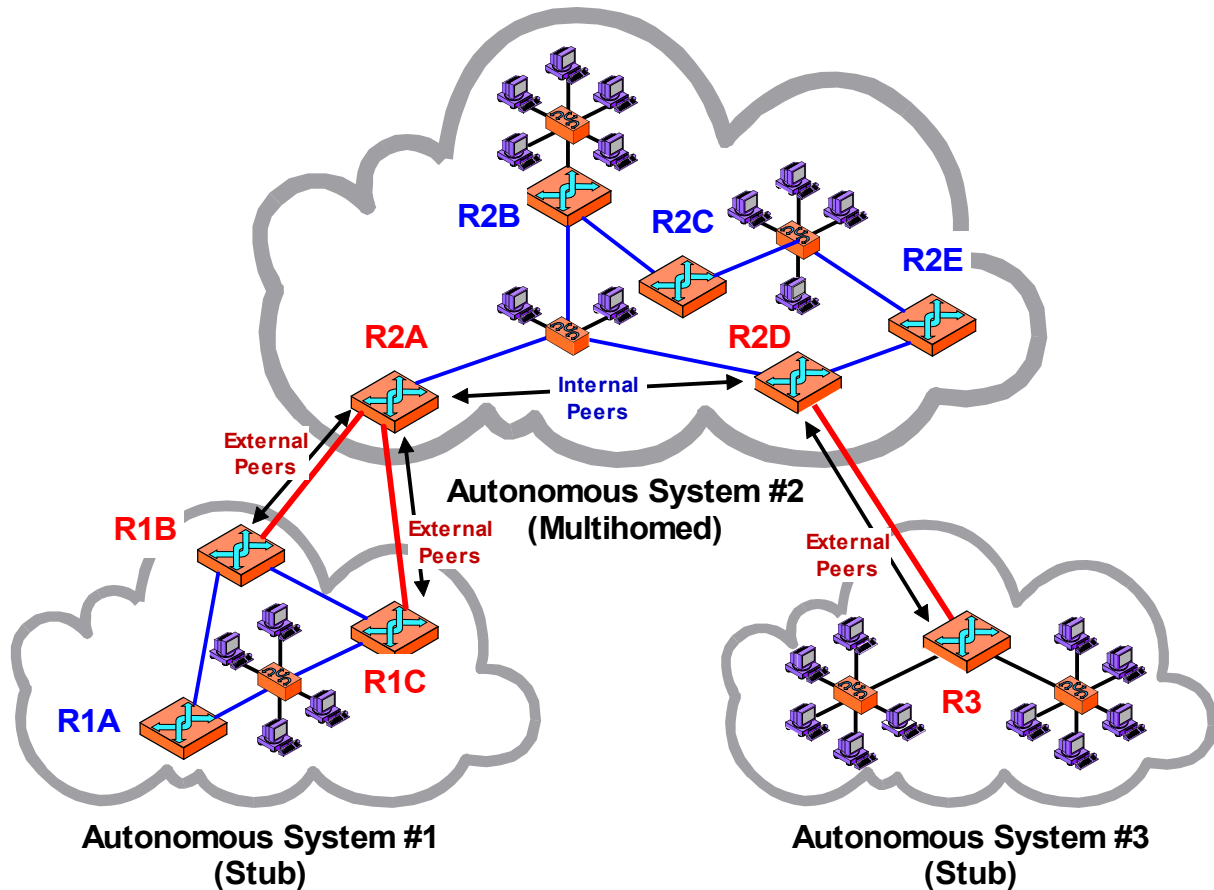

Figure 191: BGP Example Topology and Designations

This diagram is a variation on [Figure 171](#) that shows the names used by BGP to refer to different types of routers and autonomous systems. Internal routers are shown in blue while border routers are red. BGP speakers that communicate within an AS are internal peers, while those that communicate between ASes are external peers. This highly simplified internetwork shows two stub ASes, both of which only connect to the multihomed AS #2.

BGP Autonomous System Types, Traffic Flows and Routing Policies

When we connect autonomous systems (ASes) together to form an internetwork, the paths between AS border routers form the conduit by which messages move from one AS to another. It is very important that the flow of messages between ASes be carefully controlled. Depending on circumstances, we may wish to limit or even prohibit certain types of messages from going to or from a certain AS. These decisions in turn have a direct impact on BGP route determination.

BGP Traffic Flow and Traffic Types

The flow of messages in an internetwork is sometimes collectively called *traffic*. This term presents a good analogy, because we can consider the matter of traffic flow control in a BGP internetwork in much the same way we do on the streets of a city. You have probably in the past seen signs on residential streets that say “No Through Traffic” or “Local Traffic

Only”. These are attempt to control the flow of traffic over those streets. A more extreme example of this would be a street in the neighborhood where I used to live, where a barricade was intentionally erected in the middle to turn a busy through street into a pair of dead-ends. Again, the goal was traffic control.

These measures highlight a key distinction between *local traffic* and *through traffic* in a neighborhood. The very same categorization is important in BGP:

- ☉ **Local Traffic:** Traffic carried within an autonomous system that either originated in that same AS, **or** is intended to be delivered within that AS. This is like local traffic on a street.
- ☉ **Transit Traffic:** Traffic that was generated outside that AS **and** is intended to be delivered outside the AS. This is like what we commonly call *through traffic* on the streets.

BGP Autonomous System Types

In the [previous topic](#) we discussed the distinction between internal routers and border (or boundary) routers in an AS. If we look at the entire BGP internetwork, we can make a similar distinction between different types of ASes, based on how they are interconnected in the overall BGP topology. There are two main types of AS:

- ☉ **Stub AS:** This is an AS that is connected to only one other AS. It is comparable to a cul-de-sac (dead-end street) in our road analogy; usually, only vehicles coming from or going to houses on the street will be found on that street.
- ☉ **Multihomed AS:** This is an AS that is connected to two or more other ASes. It is comparable to a through street in our road analogy, because it is possible that cars may enter the street and pass through it without stopping at any of the street's houses.

In the example BGP internetwork in [Figure 191](#), I have linked border routers in AS #2 to both AS #1 and AS #3. While traffic from AS #2 can flow both to and from AS #1 and AS #3, it is possible that traffic from AS #1 may also flow to AS #3 and vice-versa. AS #2 acts as the “through street” for these datagrams.

BGP Autonomous System Routing Policies

The reason why BGP makes a distinction between traffic types and AS types is the same as why it is done on the streets: many folks have a dim view of through traffic. In a neighborhood, everyone wants to be able to get from their homes to anywhere they need to go in the city, but they don't want lots of other people using their streets. Similarly, every autonomous system must use at least one other autonomous system to communicate with distance ASes, but many are less than enthusiastic about being a conduit for lots of external traffic.

This reluctance really does make sense in many cases, both in the case of a neighborhood or in the case of BGP. Having lots of cars and trucks on a residential street can be a problem in a number of ways: safety issues, wear and tear on the road, pollution and so forth. Similarly, if a multihomed AS was forced to carry all transit traffic that other ASes want to send to it, it might become overloaded.

To provide control over the carrying of transit traffic, BGP allows an AS to set up and use *routing policies*. These are sets of rules that govern how an AS will handle transit traffic. A great deal of flexibility exists in how an AS decides to handle transit traffic. Some of the many options include:

- ☉ **No Transit Policy:** An AS can have a policy that it will not handle transit traffic at all.
- ☉ **Restricted AS Transit Policy:** An AS may allow handling of traffic from certain ASes but not others. In this case it tells the ASes it will handle that they may send it traffic, but does not say this to the others.
- ☉ **Criteria-Based Transit Policy:** An AS may use a number of different criteria to decide whether to allow transit traffic. For example, it might allow transit traffic only during certain times, or only when it has enough spare capacity.



Note: An autonomous system that is willing to carry transit traffic is sometimes called a *transit AS*.

In a similar manner, policies can be set that control how an AS will have its own traffic handled by other autonomous systems. Obviously a stub AS will always connect to the internet as a whole using the single AS to which it connects. A multihomed AS, however, may have policies that influence route selection by specifying the conditions under which one AS should be used over another. These policies may be based on considerations of security (if one connecting AS is deemed more secure than another), performance (one AS is faster than another), reliability or other factors.

Issues With Routing Policies and Internetwork Design

What would happen to a city if every street only allowed local traffic? It would be pretty hard to get around. Of course this problem never occurs in well-designed cities, because traffic planners understand the dual need for connectivity and through-traffic avoidance in residential areas. Cities are laid out in a somewhat hierarchical fashion, so local traffic “funnels” to thoroughfares intended specifically to carry non-local traffic.

The same basic situation exists in an internetwork. It wouldn't work very well if every AS declared it was not interested in carrying transit traffic! Usually, internetworks are designed so that certain autonomous systems are intended to carry large amounts of transit traffic. This is typically the function of high-speed, high-capacity backbone connections, which serve other ASes as customers. An AS will usually only carry another AS's traffic if arrangements have been made to allow this.



Key Concept: One important issue in BGP is how to handle the flow of traffic between autonomous systems. Each autonomous system in a BGP internetwork is either a *stub AS*, if it connects to only one other AS, or a *multihomed AS* if it connects to two or more others. BGP allows the administrators of a multihomed AS to establish routing policies that specify under what conditions the AS is willing to handle *transit traffic* (messages sent over the AS whose source and destination are both external to that AS.)

BGP Route Storage and Advertisement, and BGP Routing Information Bases (RIBs)

The job of the Border Gateway Protocol is to facilitate the exchange of route information between BGP devices, so that each router can determine efficient routes to each of the networks on an IP internetwork. This means that descriptions of routes are the key data that BGP devices work with. Every BGP speaker is responsible for managing route descriptions according to specific guidelines established in the BGP standards.

BGP Route Information Management Functions

Conceptually, the overall activity of route information management can be considered to encompass four main tasks:

- ① **Route Storage:** Each BGP stores information about how to reach networks in a set of special databases. It also uses databases to hold routing information received from other devices.
- ② **Route Update:** When a BGP device receives an *Update* from one of its peers, it must decide how to use this information. Special techniques are applied to determine when and how to use the information received from peers to properly update the device's knowledge of routes.
- ③ **Route Selection:** Each BGP uses the information in its route databases to select good routes to each network on the internetwork.
- ④ **Route Advertisement:** Each BGP speaker regularly tells its peers what it knows about various networks and methods to reach them. This is called *route advertisement* and is accomplished using BGP *Update* messages. We'll learn more about these messages in the next few topics, and examine them in detail in [the detailed section on BGP message formats](#).

BGP Routing Information Bases (RIBs)

The heart of BGP's system of routing information management and handling is the database where routes are stored. This database is collectively called the *Routing Information Base (RIB)*, but it is in fact not a monolithic entity. It is comprised of three separate sections that are used by a BGP speaker to handle the input and output of routing information. Two of these sections themselves consist of several individual parts, or copies.

The three RIB sections (using the cryptic names given them by the BGP standards, sorry!) are:

-
- ☉ **Adj-RIBs-In:** A set of *input* database parts that holds information about routes received from peer BGP speakers.
 - ☉ **Loc-RIB:** The *local RIB*. This is the core database that stores routes that have been selected by this BGP device and are considered valid to it.
 - ☉ **Adj-RIBs-Out:** A set of *output* database parts that holds information about routes that this BGP device has selected to be disseminated to its peers.

Thus, the RIB can be considered either a single database or a set of related databases, depending on how you look at it. (The divisions above are conceptual in nature; the entire RIB can be implemented as a single database with an internal structure representing the different components, or as separate databases.)

The RIB is a fairly complex data structure, not just because of this multi-section structure, but because BGP devices store considerably more information about routes than simpler routing protocols. Routes are also called *paths* in BGP, and the detailed descriptions of them are stored in the form of special BGP [path attributes](#).

The three sections of the RIB are the mechanism by which information flow is managed in a BGP speaker. Data received from *Update* messages transmitted by peer BGP speakers is held in the *Adj-RIBs-In*, with each *Adj-RIB-In* holding input from one peer. This data is then analyzed and appropriate portions of it selected to update the *Loc-RIB*, which is the main database of routes this BGP speaker is using. On a regular basis, information from the *Loc-RIB* is placed into the *Adj-RIBs-Out* to be sent to other peers using *Update* messages. This information flow is accomplished as part of the system of route update, selection and advertisement known as [the BGP Decision Process](#).



Key Concept: The routine operation of BGP requires BGP speakers to store, update, select and advertise routing information. The central data structure used for this purpose is the BGP *Routing Information Base (RIB)*. The RIB actually consists of three sections: a set of input databases (*Adj-RIBs-In*) that hold routing information received from peers, a local database (*Loc-RIB*) that contains the router's current routes, and a set of output databases (*Adj-RIBs-Out*) used by the router to send its routing information to other routers.

BGP Path Attributes and Algorithm Overview

Routing protocols using a [distance-vector algorithm](#) such as RIP are relatively simple in large part because the information each device stores about each route is itself simple. Each router only knows that it can reach a network at a specific cost through a particular next-hop router. It doesn't have knowledge of the route that datagrams will take to reach any of these networks. This level of knowledge is simply insufficient for the needs of a protocol like BGP.

BGP's Path-Vector Routing Algorithm and Path Attributes

In order to handle the calculation of efficient, non-looping routes in an arbitrary topology of autonomous systems, we need to know not just “to get to network N7 send to router R4”; we need to have some understanding of the characteristics of the entire path between ourselves and network N7. By storing this additional information, it is possible to make decisions about how to compute and change routes, using knowledge of the entire path between a router and a network.

Thus, in BGP, instead of advertising networks in terms of a destination and the distance to that destination, BGP devices advertise networks as destination addresses and *path descriptions* to reach those destinations. This means BGP uses, instead of a *distance-vector* algorithm, a *path-vector* algorithm. Each communication of a reachable network provides considerable information about the entire sequence of routers to a destination. Due to this inclusion of topology information, path-vector protocols are sometimes described as a combination of distance-vector and link-state algorithms. This doesn't really do them justice, however, since they do not function in the same way as either of those algorithm types.



On The Web: If you are interested in additional general information about path-vector algorithms, you can find some in [RFC 1322, A Unified Approach to Inter-Domain Routing](#). Warning: do not read before operating heavy machinery. 😊

The information about the path to each route is stored in the [Routing Information Base \(RIB\)](#) of each BGP speaker in the form of BGP *path attributes*. These attributes are used to advertise routes to networks when BGP devices send out *Update* messages. The storing, processing, sending and receiving of path attributes is “the” method by which routers decide how to create routes, so understanding them is obviously quite important.

There are several different path attributes, each of which describes a particular characteristic of a route. Attributes are divided into different categories based on their level of importance and specific rules designed to manage their propagation. The most important path attributes are called *well-known* attributes; every BGP speaker must recognize and process these, but only some are required to be sent with every route. Other attributes are *optional* and may or not be implemented. These are further differentiated based on how they are handled when received by a device that does not recognize them.

BGP Path Attribute Classes

The four formal classifications of path attributes are:

- 🌐 **Well-Known Mandatory:** These are the most important path attributes; they must be included in every route description in *Update* messages, and must be processed by each BGP device receiving them.

- ☉ **Well-Known Discretionary:** These path attributes must be recognized by a BGP device if received, but they may or may not be included in an *Update* message. Thus, they are optional for a sender of information, but mandatory for a receiver to process.
- ☉ **Optional Transitive:** These path attributes may be recognized by a BGP router and may be included in an *Update* message. They must be passed on to other BGP speakers when the route is advertised, even if received by a device that does not recognize the attribute.
- ☉ **Optional Non-Transitive:** Optional attributes that may be recognized by a BGP device and may be included in an *Update* message. If received by a device that does not recognize the attribute, it is dropped and not passed on to the next router.



Note: As you might imagine, all well-known attributes are by definition transitive—they must be passed on from one BGP speaker to the next.



Key Concept: Unlike simpler routing protocols that store only limited information about how to reach a network, such as its cost and the next hop to reach it, BGP stores detailed information about complete routes to various networks. This information takes the form of *path attributes* that describe various characteristics of a path (route) through the ASes that connect a router to a destination network.

BGP Path Attribute Characteristics

Table 136 contains a summary of the characteristics of each of the most common BGP path attributes used to describe the route to a destination, as well as the *Attribute Type* code assigned to each in BGP *Update* messages:

Table 136: Summary of BGP Path Attributes (Page 1 of 2)

BGP Path Attribute	Classification	Attribute Type Value	Description
<i>Origin</i>	Well-Known Mandatory	1	Specifies the origin of the path information. This attribute indicates whether the path came originally from an interior routing protocol, the older exterior routing protocol EGP, or some other source.
<i>AS_Path</i>	Well-Known Mandatory	2	A list of autonomous system numbers that describes the sequence of ASes through which this route description has passed. This is a critically important attribute, since it contains the actual path of autonomous systems to the network. It is used to calculate routes and to detect routing loops.
<i>Next_Hop</i>	Well-Known Mandatory	3	The next-hop router to be used to reach this destination.

Table 136: Summary of BGP Path Attributes (Page 2 of 2)

BGP Path Attribute	Classification	Attribute Type Value	Description
<i>Multi_Exit_Disc (MED)</i>	Optional Non-Transitive	4	When a path includes multiple exit or entry points to an AS, this value may be used as a metric to discriminate between them (that is, choose one exit or entry point over the others.)
<i>Local_Pref</i>	Well-Known Discretionary	5	Used in communication between BGP speakers in the same AS to indicate the level of preference for a particular route.
<i>Atomic_Aggregate</i>	Well-Known Discretionary	6	In certain circumstances, a BGP speaker may receive a set of overlapping routes where one is more specific than the other. For example, consider a route to the network 34.15.67.0/24 and to the network 34.15.67.0/26. The latter network is a subset of the former, which makes it more specific. If the BGP speaker uses the less-specific route (in this case, 34.15.67.0/24) it sets this path attribute to a value of 1 to indicate that this was done.
<i>Aggregator</i>	Optional Transitive	7	Contains the AS number and BGP ID of the router that performed route aggregation; used for troubleshooting.

Some of these path attributes are straight-forward to understand; others are fairly cryptic and probably confusing. Delving into any more detail on the path attributes leads us into a full-blown description of detailed inter-AS route calculations. We'll look at that to some degree in [the next topic](#).

For full details on the message format used to communicate path attributes, see [the format of BGP Update messages](#).

BGP Route Determination and the BGP Decision Process

The last two topics have described the fundamentals of how BGP devices store and manage information about routes to networks. This included an overview of the four route information management activities performed by BGP speakers: route storage, update, selection and advertisement. [Route storage is the function of the Routing Information Base \(RIB\)](#) in each BGP speaker. [Path attributes](#) are the mechanism by which BGP stores details about routes and also describes those details to BGP peers.

BGP Decision Process Phases

As we have seen, the RIB also contains sections for holding input information received from BGP peers, and for holding output information each BGP device wants to send to those peers. The functions of route update, selection and advertisement are concerned with analyzing this input information, deciding what to include in the local database, updating

that database, and then choosing what routes to send from it to peer devices. In BGP, a mechanism called the *Decision Process* is responsible for these tasks. It consists of three overall phases:

1. **Phase 1:** Each route received from a BGP speaker in a neighboring AS is analyzed and assigned a preference level. The routes are then ranked according to preference and the best one for each network advertised to other BGP speakers within the autonomous system.
2. **Phase 2:** The best route for each destination is selected from the incoming data based on preference levels, and used to update the local routing information base (the *Loc-RIB*).
3. **Phase 3:** Routes in the *Loc-RIB* are selected to be sent to neighboring BGP speakers in other ASes.

Criteria for Assigning Preferences to Routes

Obviously, if a BGP speaker only knows of a single route to a network, it will install and use that route (assuming there are no problems with it). The assigning of preferences amongst routes only becomes important when more than one route has been received by a BGP speaker for a particular network. Preferences can be determined based on a number of different criteria. Just a few typical ones include:

- ☉ The number of autonomous systems between the router and the network (fewer generally being better).
- ☉ The existence of certain policies that may make certain routes unusable; for example, a route may pass through an AS that this AS is not willing to trust with its data.
- ☉ The origin of the path—that is, where it came from.

In the case where a set of routes to the same network are all calculated to have the same preference, a “tie-breaking” scheme is used to select from among them. Additional logic is used to handle special circumstances, such as the case of overlapping networks ([see the description of the Atomic_Aggregate path attribute](#) for an example of this).

The selection of routes for dissemination to other routers in Phase 3 is based on a rather complex algorithm that I cannot do justice here. Route advertisement is guided by the [routing policies](#) we discussed earlier in this section. Different rules are used to select routes for advertising to internal peers compared to external peers.



Key Concept: The method used by a BGP speaker to determine what new routes to accept from its peers and what routes to advertise back them is called the *BGP Decision Process*. It is a complex algorithm in three phases that involves the computation of the best route based on both pre-existing and incoming path information.

Limitations on BGP's Ability to Select Efficient Routes

When considering the route selection process, it's very important to remember that BGP is a routing protocol that operates at the *inter-autonomous-system* level. Thus, routes are chosen between ASes and not at the level of individual routers within an AS. So, for example, when BGP stores information about the path to a network, it stores it as a sequence of autonomous systems, not a sequence of specific routers. BGP cannot deal with individual routers in an AS because by definition, the details of what happens within an AS are supposed to be “hidden” from the outside world. It doesn't know the structure of ASes outside its own.

However, this has an important implication for how BGP selects routes: BGP cannot guarantee that it will pick the fastest, lowest-cost route to every network. It can select a route that minimizes the number of ASes that lie between itself and a particular network, but of course ASes are not all the same. Some ASes are large and consist of many slow links, while others are small and fast. Choosing a route through two of the latter type of AS will be better than choosing a route through one of the former, but BGP can't know that. Policies can be used to influence AS selection to some extent, but in general, since BGP doesn't know what happens in an AS, it cannot guarantee the efficiency of a route overall. (Incidentally, this is the reason why there is no general “cost” or “distance” path attribute in BGP.)



Key Concept: As an exterior routing protocol, BGP operates at the autonomous system level. Its routes are calculated based on paths between ASes, not individual routers. Since BGP, by definition, does not know the internal structure of routers within an AS, it cannot know for certain the cost to send a datagram across a given AS. This in turn means that BGP cannot always guarantee that it will select the absolute lowest-cost route between any two networks.

Originating New Routes and Withdrawing Unreachable Routes

Naturally, a facility exists to allow BGP speakers to originate new routes to networks. A BGP speaker may obtain knowledge about a new route from an interior routing protocol on an AS to which it is directly attached and choose to share this information with other ASes. It will create a new entry in its RIB for this network and then send information about it out to other BGP peers.

BGP also includes a mechanism for not only advertising routes it can reach, but those it cannot. The latter are called *unfeasible* or *withdrawn* routes, and are [mentioned in Update messages as needed](#) to indicate that a router can no longer reach the specific network.

BGP General Operation and Messaging

In the previous topics we have seen how BGP stores information about routes and uses it to determine paths to various networks. Let's now take a high-level look at how BGP operates in general terms. Like many other protocols covered in this Guide, BGP's

operation can be described primarily in the form of messaging. The use of messages is the means by which route information is communicated between BGP peers. This eventually allows knowledge of how to reach networks to spread throughout the entire internetwork.

Speaker Designation and Connection Establishment

Before messaging can begin, [BGP speakers must be designated](#), and then linked together. The BGP standard does not specify how neighboring speakers are determined; this must be done outside the protocol. Once accomplished, ASes are connected into a BGP-enabled internetwork. Topological linking provides the physical connection and the means for datagrams to flow between ASes. At this point the dance floor is prepared, but nobody is dancing; BGP can function but isn't yet in operation.

BGP operation begins with BGP peers forming a transport protocol connection. BGP uses [TCP](#) for its reliable transport layer, so the two BGP speakers establish a TCP session that remains in place during the course of the subsequent message exchange. When this is done, each BGP speaker sends a BGP *Open* message. This message is like an “invitation to dance”, and begins the process of setting up the BGP link between the devices. In this message, each router identifies itself and its autonomous system, and also tells its peer what parameters it would like to use for the link. This includes an exchange of authentication parameters. Assuming that each device finds the contents of its peer's *Open* message acceptable, it acknowledges it with a *Keepalive* message and the BGP session begins.

Under normal circumstances, most BGP speakers will maintain simultaneous sessions with more than one other BGP speaker, both within its own AS and outside the AS. Links between ASes are of course what enable BGP routers to learn how to route through the internetwork. Links within the AS are important to ensure that each BGP speaker in the AS maintains consistent information.

Route Information Exchange

Assuming the link is initialized, the two peers begin an ongoing process of telling each other what they know about networks and how to reach them. Each BGP speaker encodes information from its [Routing Information Bases \(RIBs\)](#) into BGP *Update* messages. These messages contain lists of known network addresses, as well as information about paths to various networks, described in the form of [path attributes](#). This information is then used for the route determination as described in the preceding topic.

When a link is first set up between two peers, they ensure complete information is held by each router by exchanging their complete routing tables. Subsequently, *Update* messages are sent that contain only incremental updates about routes that have changed. Exchanging only updated information as needed reduces unnecessary bandwidth on the network, making BGP more efficient than it would be if it sent full routing table information on a regular basis.

Connectivity Maintenance

The TCP session between BGP speakers can be kept open for a very long time, but *Updates* need to be sent only when changes occur to routes, which are usually infrequent. This means many seconds may elapse between the transmission of *Update* messages. To ensure that the peers maintain contact with each other, they both send *Keepalive* messages on a regular basis when they don't have other information to send. These are null messages that contain no data and just tell the peer device "I'm still here". These messages are sent infrequently—no more often than one per second—but regularly enough that the peers won't think the session was interrupted.

Error Reporting

The last type of BGP message is the BGP *Notification* message. This is an error message; it tells a peer that a problem occurred and describes the nature of the error condition. After sending a BGP *Notification* message, the device that sent it will terminate the BGP connection between the peers. A new connection will then need to be negotiated, possibly after the problem that led to the *Notification* has been corrected.



Key Concept: BGP is implemented through the exchange of four different message types between BGP speakers. A BGP session begins with a TCP connection being established between two routers and each sending an *Open* message to the other. BGP *Update* messages are the primary mechanism by which routing information is exchanged between devices. Small BGP *Keepalive* messages are used to maintain communication between devices between periods that they need to exchange information. Finally, *Notification* messages are used for problem reporting.

For more details on the four BGP message types and a description of the format used by each, refer to [the detailed BGP operation section](#).



BGP Detailed Messaging, Operation and Message Formats

The [previous section](#) described the concepts and general operation of the Border Gateway Protocol (BGP). To get a better understanding of exactly how BGP works, it is helpful to take a deeper look at its four different message types and how they are used. As we do this, we can examine the fields in each message type, to help us comprehend not just the way that messaging is accomplished, but the way that routing data is actually communicated.

In this section I provide a comprehensive description of the communication that takes place between BGP speakers by providing details on BGP message types, how they are used, and the data elements they contain. I begin with a description of common attributes of BGP message generation and transport, and the general format used for all BGP messages. I then provide a detailed description of each of the four BGP message types: *Open*, *Update*, *Keepalive* and *Notification* messages.



Background Information: If you have not yet already done so, you should read [the high-level description of general BGP operation and messaging](#), which shows how these messages fit together.

BGP Message Generation and Transport, and General Message Format

Each router running BGP generates messages to implement the various functions of the protocol. Some of these messages are created on a regular basis by the BGP software during the course of its normal operation. These are generally controlled by timers that are set and count down to cause them to be sent. Other messages are sent in response to messages received from BGP peers, possibly after a processing step.

BGP Message Transport

BGP is different from most other routing protocols in that it was designed from the start to operate using a *reliable* method of message delivery. The [Transmission Control Protocol \(TCP\)](#) is present in the software of every IP router, making it the obvious choice for reliable data communication in a TCP/IP internet, and that's what BGP uses. Routing protocols are usually considered part of layer three, but this one runs over a layer four protocol, making BGP a good example of why architectural [models are best used only as a guideline](#).

TCP provides numerous advantages to BGP by taking care of most of the details of session setup and management, allowing BGP to focus on the data it needs to send. TCP takes care of session setup and negotiation, ensuring that messages are received and acknowledged, flow control, congestion-handling and any necessary retransmissions of lost messages. BGP uses well-known TCP port 179 for connections.

BGP General Message Format

The use of TCP also has an interesting impact on the way BGP messages are structured. One thing that stands out when you look at the BGP message format (as we will see shortly) is that a BGP message can have an odd number of bytes. Most routing protocols are sized in units of 4 or 8 bytes, but since TCP sends data as a stream of octets there is no need for BGP messages to break on a 32-bit or 64-bit boundary. The other impact is the need of a special *Marker* field to help ensure that BGP messages can be differentiated from each other in the TCP stream (more about this in a moment).

Like most messaging protocols, BGP uses a common message format for each of its four message types. Each BGP message is conceptually divided into a header and a body (called the *data portion* in the BGP standard). The header has three fields and is fixed in length at 19 bytes. The body is variable in length, and in fact is omitted entirely in *Keepalive* messages, since it is not needed for them.

The general format for all BGP message types is shown in [Table 137](#) and [Figure 192](#).

Table 137: BGP General Message Format

Field Name	Size (bytes)	Description										
Marker	16	Marker: This large field at the start of each BGP message is used for synchronization and authentication.										
Length	2	Length: The total length of the message in bytes, including the fields of the header. The minimum value of this field is 19 for a <i>Keepalive</i> message; it may be as high as 4,096.										
Type	1	Type: Indicates the BGP message type: <table border="1"><thead><tr><th>Type Value (Decimal)</th><th>Message Type</th></tr></thead><tbody><tr><td>1</td><td><i>Open</i></td></tr><tr><td>2</td><td><i>Update</i></td></tr><tr><td>3</td><td><i>Notification</i></td></tr><tr><td>4</td><td><i>Keepalive</i></td></tr></tbody></table>	Type Value (Decimal)	Message Type	1	<i>Open</i>	2	<i>Update</i>	3	<i>Notification</i>	4	<i>Keepalive</i>
Type Value (Decimal)	Message Type											
1	<i>Open</i>											
2	<i>Update</i>											
3	<i>Notification</i>											
4	<i>Keepalive</i>											
Message Body / Data Portion	Variable	Message Body / Data Portion: Contains the specific fields used to implement each message type, for <i>Open</i> , <i>Update</i> and <i>Notification</i> messages.										

The Marker Field, Message Synchronization and Authentication

The *Marker* field is the most interesting one in the BGP message format, and as mentioned in the table is used for both synchronization and authentication. BGP uses a single TCP session to send many messages in a row. TCP is a stream-oriented transport protocol

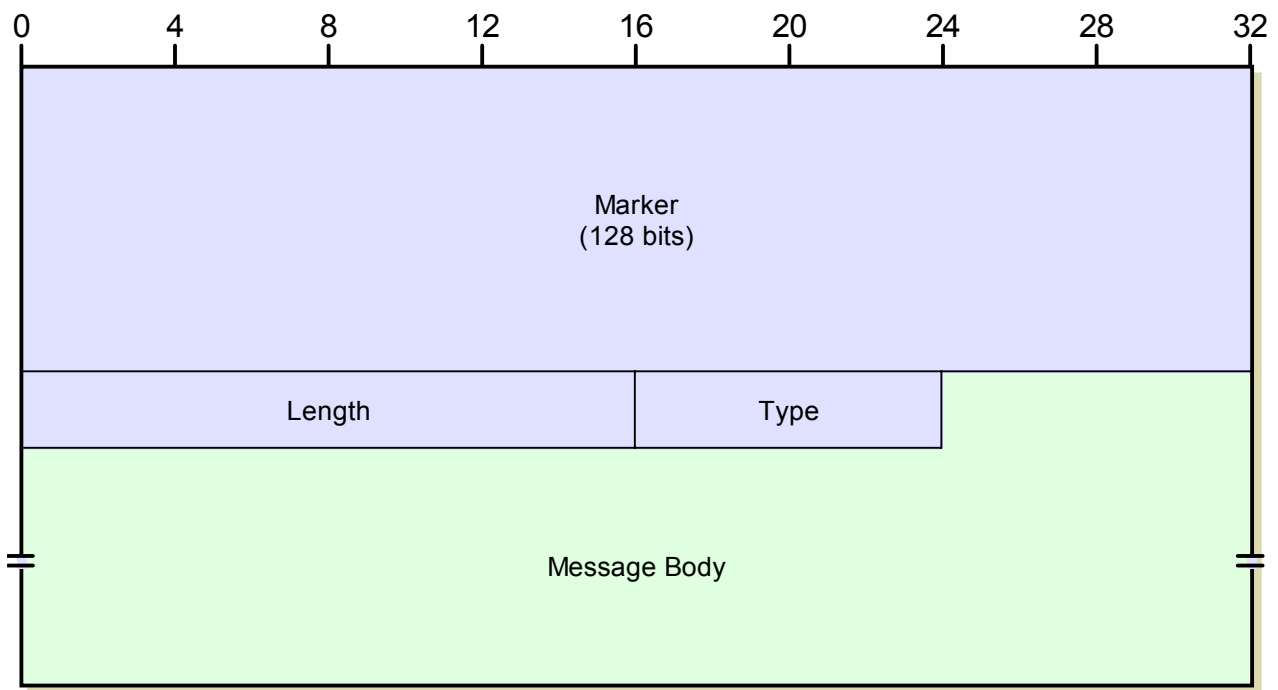

Figure 192: BGP General Message Format

which just sends bytes across the link without any knowledge of what the bytes represent. This means that [the protocol using TCP is responsible for deciding where the line is drawn between data units](#), in this case BGP messages.

Normally, the *Length* field tells each BGP device where to draw the line between the end of one message and the start of the next. However, it is possible that due to various conditions a device might lose track of where the message boundary is. The *Marker* field is filled with a recognizable pattern that clearly marks the start of each message, to keep BGP peers synchronized.

Before a BGP connection is established, the *Marker* field is just filled with all ones. Thus, this is the pattern used for *Open* messages. Once a BGP session is negotiated, if agreement is reached on an authentication method between the two devices, the *Marker* field takes on the additional role of authentication. Instead of looking for a *Marker* containing all ones, BGP devices look for a pattern generated using the agreed-upon authentication method. Detection of this pattern simultaneously synchronizes the devices and ensures that messages are authentic.

In extreme cases, BGP peers may be unable to maintain synchronization, and if so, a *Notification* message is generated and the session is closed. This will also happen if the *Marker* field contains the wrong data when authentication is enabled.



Key Concept: All four BGP message types use a general message format that contains three fixed header fields—*Marker*, *Length* and *Type*—and room for a message body that differs for each message type. The large *Marker* field is used to denote the start of a new BGP message, and is also used to facilitate the BGP authentication method.

BGP Connection Establishment: Open Messages

Before a BGP session can be used to exchange routing information, a connection must first be established between BGP peers. This process begins with the creation of a TCP connection between the devices. Once this is done, the BGP devices will attempt to create a BGP session by exchanging BGP *Open* messages.

The *Open* message has two main purposes. The first is identification and initiation of a link between the two devices; it allows one peer to tell the other “I am a BGP speaker named X on autonomous system Y, and I want to start exchanging BGP information with you”. The second is negotiation of session parameters. These are the terms by which the BGP session will be conducted. One important parameter negotiated using *Open* messages is the method that each device wants to use for authentication. The importance of BGP means that authentication is essential, to avoid bad information or a malicious person from disrupting routes.

Each BGP receiving an *Open* message processes it. If its contents are acceptable, including the parameters the other device wants to use, it responds with a *Keepalive* message as an acknowledgment. Each peer must send an *Open* and receive a *Keepalive* acknowledgment for the BGP link to be initialized. If either is not willing to accept the terms of the *Open*, the link is not established. In that case, a *Notification* message may be sent to convey the nature of the problem.

BGP Open Message Format

The specific format for BGP *Open* messages can be found in [Table 138](#) and [Figure 193](#).

Table 138: BGP *Open* Message Format (Page 1 of 2)

Field Name	Size (bytes)	Description
<i>Marker</i>	16	Marker: This large field at the start of each BGP message is used for synchronization and authentication. See the discussion of the BGP general message format for details.
<i>Length</i>	2	Length: The total length of the message in bytes, including the fields of the header. <i>Open</i> messages are variable in length.
<i>Type</i>	1	Type: BGP message type, value is 1 for <i>Open</i> messages.

Table 138: BGP Open Message Format (Page 2 of 2)

Field Name	Size (bytes)	Description												
Version	1	Version: Indicates the BGP version the sender of the <i>Open</i> message is using. This field allows devices to reject connections with devices using versions they may not be capable of understanding. The current value is 4, for BGP-4, and is used by most, if not all, current BGP implementations.												
My Autonomous System	2	My Autonomous System: Identifies the autonomous system number of the sender of the <i>Open</i> message. AS numbers are centrally managed across the Internet in a manner similar to how IP addresses are administered.												
Hold Time	2	Hold Time: The number of seconds that this device proposes to use for the BGP hold timer, which specifies how long a BGP peer will allow the connection to be left silent between receipt of BGP messages. A BGP device may refuse a connection if it doesn't like the value that its peer is suggesting; usually, however, the two devices agree to use the smaller of the values suggested by each device. The value must be at least 3 seconds, or 0. If 0, this specifies that the hold timer is not used. See the Keepalive message discussion for more on how the hold timer is used.												
BGP Identifier	4	BGP Identifier: Identifies the specific BGP speaker. Recall that IP addresses are associated with interfaces, not devices, so each router will have at least two IP addresses. Normally the BGP identifier is chosen as one of these addresses. Once chosen, this identifier is used for all BGP communications with BGP peers. This includes BGP peers on the interface from which the identifier was chosen, and also BGP peers on other interfaces as well. So, if a BGP speaker with two interfaces has addresses <i>IP1</i> and <i>IP2</i> , it will choose one as its identifier and use it on both of its interfaces.												
Opt Parm Len	1	Optional Parameters Length: The number of bytes used for <i>Optional Parameters</i> (see below). If 0, no optional parameters are in this message.												
Optional Parameters	Variable	<p>Optional Parameters: Allows the <i>Open</i> message to communicate any number of extra parameters during BGP session setup. Each parameter is encoded using a rather standard “type / length / value” triple, as follows:</p> <table border="1"> <thead> <tr> <th>Subfield Name</th> <th>Size (bytes)</th> <th>Description</th> </tr> </thead> <tbody> <tr> <td>Parm Type</td> <td>1</td> <td>Parameter Type: The type of optional parameter. At present, only one value is defined, 1, for authentication Information.</td> </tr> <tr> <td>Parm Length</td> <td>1</td> <td>Parameter Length: Specifies the length of the <i>Parameter Value</i> subfield (thus, this value is the length of the entire parameter less 2).</td> </tr> <tr> <td>Parm Value</td> <td>Variable</td> <td>Parameter Value: The value of the parameter being communicated.</td> </tr> </tbody> </table>	Subfield Name	Size (bytes)	Description	Parm Type	1	Parameter Type: The type of optional parameter. At present, only one value is defined, 1, for authentication Information.	Parm Length	1	Parameter Length: Specifies the length of the <i>Parameter Value</i> subfield (thus, this value is the length of the entire parameter less 2).	Parm Value	Variable	Parameter Value: The value of the parameter being communicated.
Subfield Name	Size (bytes)	Description												
Parm Type	1	Parameter Type: The type of optional parameter. At present, only one value is defined, 1, for authentication Information.												
Parm Length	1	Parameter Length: Specifies the length of the <i>Parameter Value</i> subfield (thus, this value is the length of the entire parameter less 2).												
Parm Value	Variable	Parameter Value: The value of the parameter being communicated.												

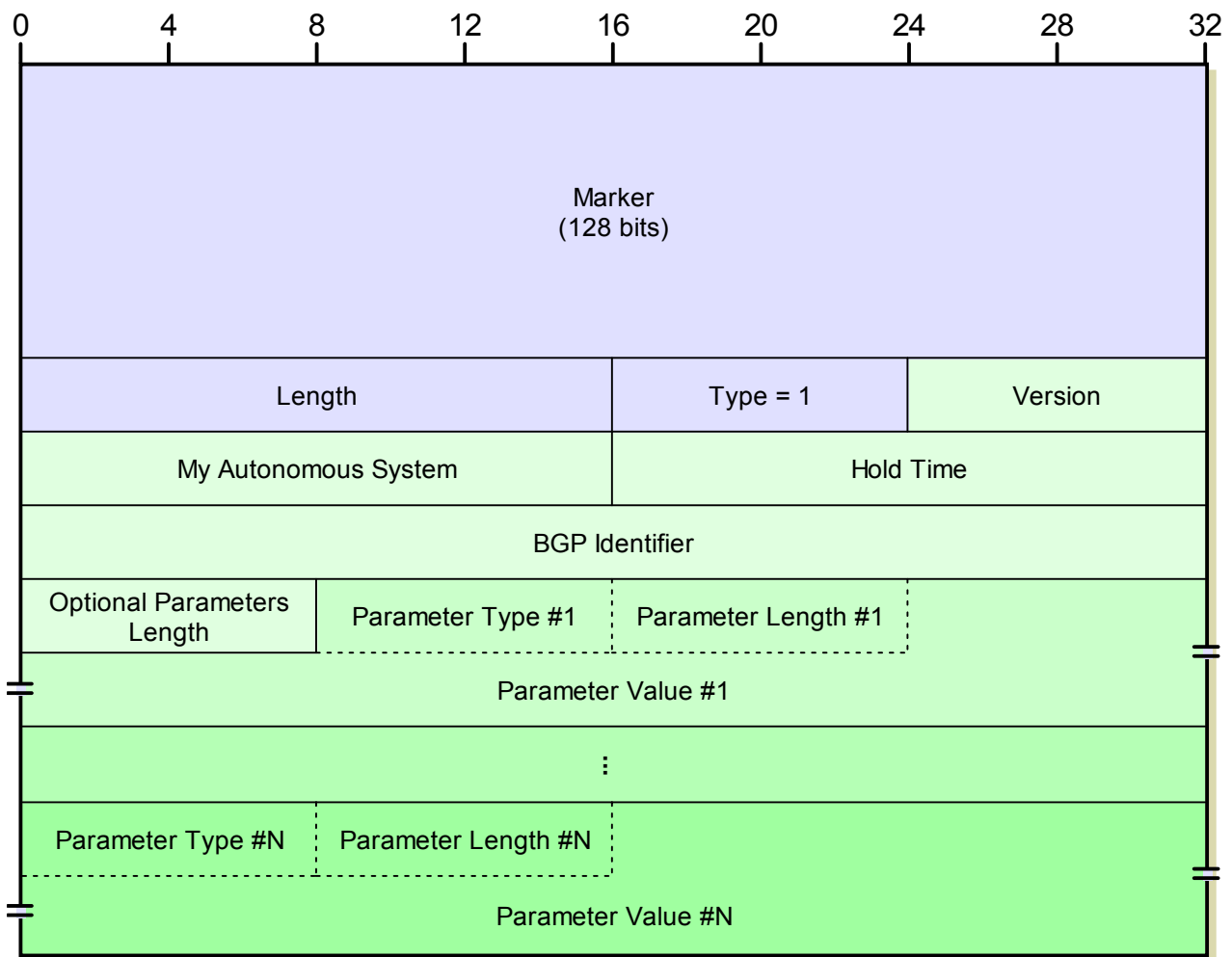

Figure 193: BGP Open Message Format

BGP *Open* messages currently use only one optional parameter: *Authentication Information*. Its *Parameter Value* subfield contains a one-byte *Authentication Code* sub-subfield, which specifies the type of authentication a device wishes to use. Following this is a variable-length *Authentication Data* sub-subfield. The *Authentication Code* specifies how authentication is to be performed, including the meaning of the *Authentication Data* field, and the manner in which *Marker* fields are to be calculated.



Key Concept: BGP sessions begin with each peer in a connection sending the other a BGP Open message. The purpose of this message is to establish contact between devices, identify the sender of the message and its autonomous system, and negotiate important parameters that dictate how the session will be conducted.

BGP Route Information Exchange: Update Messages

Once BGP speakers have made contact and a link has been established using *Open* messages, the devices begin the actual process of exchanging routing information. Each BGP router uses the [BGP Decision Process](#) to select certain routes to be advertised to its peer. This information is then placed into BGP *Update* messages, which are sent to every BGP device for which a session has been established. These messages are the way that network reachability knowledge is propagated around the internetwork.

Each *Update* message contains either one or both of the following:

- ☉ **Route Advertisement:** The characteristics of a single route.
- ☉ **Route Withdrawal:** A list of networks that are no longer reachable.

Only one route can be advertised in an *Update* message, but several can be withdrawn. This is because withdrawing a route is simple; it requires simply the address of the network for which the route is being removed. In contrast, a route advertisement requires a fairly complex set of [path attributes](#) to be described, which takes up a significant amount of space. (Note that it is possible for an *Update* to only specify withdrawn routes and not advertise a route at all.)

BGP Update Message Format

Because of the amount of information it contains, and the complexity of that information, BGP Update messages use one of the most complicated structures in all of TCP/IP. The basic structure of the message is described in [Table 139](#), and illustrated in [Figure 194](#). As you can see in that table, several of the fields have their own substructure. The Attribute Type subfield of the Path Attributes field has itself a complex substructure, which I have shown separately in [Table 140](#) to avoid overloading [Table 139](#).

When you examine this format, you may find it confusing that there can be more than one prefix in the *NLRI* field, given that I just said that an *Update* message advertises only one route. There is in fact no inconsistency here. A single route may be associated with more than one network; or, to put it another way, multiple networks may have the same path and path attributes. In that case, specifying multiple network prefixes in the same *Update* is more efficient than generating a new one for each network.

Table 139: BGP Update Message Format (Page 1 of 3)

Field Name	Size (bytes)	Description
Marker	16	Marker: This large field at the start of each BGP message is used for synchronization and authentication. See the discussion of the BGP general message format for details.
Length	2	Length: The total length of the message in bytes, including the fields of the header. <i>Update</i> messages are variable in length.
Type	1	Type: BGP message type, value is 2 for <i>Update</i> messages.

Table 139: BGP Update Message Format (Page 2 of 3)

Field Name	Size (bytes)	Description									
Unfeasible Routes Length	2	Unfeasible Routes Length: The length of the <i>Withdrawn Routes</i> field, in bytes. If 0, no routes are being withdrawn and the <i>Withdrawn Routes</i> field is omitted.									
Withdrawn Routes	Variable	<p>Withdrawn Routes: Specifies the addresses of networks for which routes are being withdrawn from use. Each address is specified using the following substructure:</p> <table border="1"> <thead> <tr> <th>Subfield Name</th> <th>Size (bytes)</th> <th>Description</th> </tr> </thead> <tbody> <tr> <td>Length</td> <td>1</td> <td>Length: The number of bits in the IP address <i>Prefix</i> subfield below that are significant.</td> </tr> <tr> <td>Prefix</td> <td>Variable</td> <td> <p>Prefix: The IP address prefix of the network whose route is being withdrawn. If the number of bits in the prefix is not a multiple of 8, this field is padded with zeroes so it falls on a byte boundary.</p> <p>The length of this field is 1 byte if the preceding <i>Length</i> field is 8 or less; 2 bytes if it is 9 to 16; 3 bytes if it is 17 to 24; and 4 bytes if 25 or greater.</p> </td> </tr> </tbody> </table>	Subfield Name	Size (bytes)	Description	Length	1	Length: The number of bits in the IP address <i>Prefix</i> subfield below that are significant.	Prefix	Variable	<p>Prefix: The IP address prefix of the network whose route is being withdrawn. If the number of bits in the prefix is not a multiple of 8, this field is padded with zeroes so it falls on a byte boundary.</p> <p>The length of this field is 1 byte if the preceding <i>Length</i> field is 8 or less; 2 bytes if it is 9 to 16; 3 bytes if it is 17 to 24; and 4 bytes if 25 or greater.</p>
Subfield Name	Size (bytes)	Description									
Length	1	Length: The number of bits in the IP address <i>Prefix</i> subfield below that are significant.									
Prefix	Variable	<p>Prefix: The IP address prefix of the network whose route is being withdrawn. If the number of bits in the prefix is not a multiple of 8, this field is padded with zeroes so it falls on a byte boundary.</p> <p>The length of this field is 1 byte if the preceding <i>Length</i> field is 8 or less; 2 bytes if it is 9 to 16; 3 bytes if it is 17 to 24; and 4 bytes if 25 or greater.</p>									
Total Path Attribute Length	2	Total Path Attribute Length: The length of the <i>Path Attributes</i> field, in bytes. If 0, indicates no route is being advertised in this message, so <i>Path Attributes</i> and <i>Network Layer Reachability Information</i> are omitted.									

Table 139: BGP Update Message Format (Page 3 of 3)

Field Name	Size (bytes)	Description												
Path Attributes	Variable	<p>Path Attributes: Describes the path attributes of the route advertised. Since some attributes require more information than others, attributes are described using a flexible structure that minimizes message size compared to using fixed fields that would often be empty. Unfortunately it also makes the field structure confusing. ☺ Each attribute has the following subfields:</p> <table border="1"> <thead> <tr> <th>Subfield Name</th> <th>Size (bytes)</th> <th>Description</th> </tr> </thead> <tbody> <tr> <td>Attribute Type</td> <td>2</td> <td>Attribute Type: A two-byte subfield that defines the type of attribute and describes it. This subfield itself has a two-level substructure, so it won't even fit it here! See Table 140.</td> </tr> <tr> <td>Attribute Length</td> <td>1 or 2</td> <td>Attribute Length: The length of the attribute in bytes. This field is normally one byte, allowing for fields with a length up to 255 bytes. For longer attributes, the <i>Extended Length</i> flag is set (see Table 140), indicating that this <i>Attribute Length</i> field is two bytes, for attributes up to 65,535 bytes.</td> </tr> <tr> <td>Attribute Value</td> <td>Variable</td> <td>Attribute Value: The value of the attribute. The size and meaning of this field depends on the type of path attribute. For example, for an <i>Origin</i> attribute it is a single integer value indicating the origin of the route; for an <i>AS_Path</i> attribute this field contains a variable-length list of the autonomous systems in the path to the network.</td> </tr> </tbody> </table>	Subfield Name	Size (bytes)	Description	Attribute Type	2	Attribute Type: A two-byte subfield that defines the type of attribute and describes it. This subfield itself has a two-level substructure, so it won't even fit it here! See Table 140 .	Attribute Length	1 or 2	Attribute Length: The length of the attribute in bytes. This field is normally one byte, allowing for fields with a length up to 255 bytes. For longer attributes, the <i>Extended Length</i> flag is set (see Table 140), indicating that this <i>Attribute Length</i> field is two bytes, for attributes up to 65,535 bytes.	Attribute Value	Variable	Attribute Value: The value of the attribute. The size and meaning of this field depends on the type of path attribute. For example, for an <i>Origin</i> attribute it is a single integer value indicating the origin of the route; for an <i>AS_Path</i> attribute this field contains a variable-length list of the autonomous systems in the path to the network.
		Subfield Name	Size (bytes)	Description										
		Attribute Type	2	Attribute Type: A two-byte subfield that defines the type of attribute and describes it. This subfield itself has a two-level substructure, so it won't even fit it here! See Table 140 .										
		Attribute Length	1 or 2	Attribute Length: The length of the attribute in bytes. This field is normally one byte, allowing for fields with a length up to 255 bytes. For longer attributes, the <i>Extended Length</i> flag is set (see Table 140), indicating that this <i>Attribute Length</i> field is two bytes, for attributes up to 65,535 bytes.										
Attribute Value	Variable	Attribute Value: The value of the attribute. The size and meaning of this field depends on the type of path attribute. For example, for an <i>Origin</i> attribute it is a single integer value indicating the origin of the route; for an <i>AS_Path</i> attribute this field contains a variable-length list of the autonomous systems in the path to the network.												
Network Layer Reachability Information	Variable	<p>Network Layer Reachability Information (NLRI): Contains a list of IP address prefixes for the route being advertised. Each address is specified using the same general structure as that used for <i>Withdrawn Routes</i>:</p> <table border="1"> <thead> <tr> <th>Subfield Name</th> <th>Size (bytes)</th> <th>Description</th> </tr> </thead> <tbody> <tr> <td>Length</td> <td>1</td> <td>Length: The number of bits in the <i>Prefix</i> field below that are significant.</td> </tr> <tr> <td>Prefix</td> <td>Variable</td> <td>Prefix: The IP address prefix of the network whose route is being advertised. If the number of bits in the prefix is not a multiple of 8, this field is padded with zeroes so it falls on a byte boundary. The length of this field is 1 byte if the preceding <i>Length</i> field is 8 or less; 2 bytes if it is 9 to 16; 3 bytes if it is 17 to 24; and 4 bytes if 25 or greater.</td> </tr> </tbody> </table> <p>Unlike most of the other fields in the <i>Update</i> message, the length of the <i>NLRI</i> field is not explicitly stated. It is computed from the overall message <i>Length</i> field, less the lengths of the other fields that are explicitly specified.</p>	Subfield Name	Size (bytes)	Description	Length	1	Length: The number of bits in the <i>Prefix</i> field below that are significant.	Prefix	Variable	Prefix: The IP address prefix of the network whose route is being advertised. If the number of bits in the prefix is not a multiple of 8, this field is padded with zeroes so it falls on a byte boundary. The length of this field is 1 byte if the preceding <i>Length</i> field is 8 or less; 2 bytes if it is 9 to 16; 3 bytes if it is 17 to 24; and 4 bytes if 25 or greater.			
		Subfield Name	Size (bytes)	Description										
		Length	1	Length: The number of bits in the <i>Prefix</i> field below that are significant.										
Prefix	Variable	Prefix: The IP address prefix of the network whose route is being advertised. If the number of bits in the prefix is not a multiple of 8, this field is padded with zeroes so it falls on a byte boundary. The length of this field is 1 byte if the preceding <i>Length</i> field is 8 or less; 2 bytes if it is 9 to 16; 3 bytes if it is 17 to 24; and 4 bytes if 25 or greater.												

Table 140: Details of BGP Update Message Attribute Type Subfield

Sub-subfield Name	Size (bytes)	Description																		
Attribute Flags	1	<p>Attribute Flags: A set of flags that describe the nature of the attribute and how to process it (you may need to refer to the path attributes description to make sense of these flags):</p> <table border="1"> <thead> <tr> <th>Sub-Sub-Subfield Name</th> <th>Size (bytes)</th> <th>Description</th> </tr> </thead> <tbody> <tr> <td>Optional</td> <td>1/8 (1 bit)</td> <td>Optional Bit: Set to 1 for optional attributes; 0 for well-known attributes.</td> </tr> <tr> <td>Transitive</td> <td>1/8 (1 bit)</td> <td>Transitive Bit: Set to 1 for optional transitive attributes; 0 for optional non-transitive attributes. Always set to 1 for well-known attributes.</td> </tr> <tr> <td>Partial</td> <td>1/8 (1 bit)</td> <td>Partial Bit: When 1, indicates that information about an optional transitive attribute is "partial". This means that since it was optional and transitive, one or more of the routers that passed the path along did not implement that attribute but was forced to pass it along, so information about it may be missing (not supplied by the routers that didn't recognize it but just passed it along). If 0, means information is complete. This bit has meaning only for optional transitive attributes; for well-known or non-transitive attributes it is 0.</td> </tr> <tr> <td>Extended Length</td> <td>1/8 (1 bit)</td> <td>Extended Length Bit: Set to 1 for long attributes, to indicate that the <i>Attribute Length</i> field is two bytes in size. Normally 0, meaning the <i>Attribute Length</i> field is a single byte.</td> </tr> <tr> <td>Reserved</td> <td>4/8 (4 bits)</td> <td>Reserved: Set to zero and ignored.</td> </tr> </tbody> </table>	Sub-Sub-Subfield Name	Size (bytes)	Description	Optional	1/8 (1 bit)	Optional Bit: Set to 1 for optional attributes; 0 for well-known attributes.	Transitive	1/8 (1 bit)	Transitive Bit: Set to 1 for optional transitive attributes; 0 for optional non-transitive attributes. Always set to 1 for well-known attributes.	Partial	1/8 (1 bit)	Partial Bit: When 1, indicates that information about an optional transitive attribute is "partial". This means that since it was optional and transitive, one or more of the routers that passed the path along did not implement that attribute but was forced to pass it along, so information about it may be missing (not supplied by the routers that didn't recognize it but just passed it along). If 0, means information is complete. This bit has meaning only for optional transitive attributes; for well-known or non-transitive attributes it is 0.	Extended Length	1/8 (1 bit)	Extended Length Bit: Set to 1 for long attributes, to indicate that the <i>Attribute Length</i> field is two bytes in size. Normally 0, meaning the <i>Attribute Length</i> field is a single byte.	Reserved	4/8 (4 bits)	Reserved: Set to zero and ignored.
		Sub-Sub-Subfield Name	Size (bytes)	Description																
		Optional	1/8 (1 bit)	Optional Bit: Set to 1 for optional attributes; 0 for well-known attributes.																
		Transitive	1/8 (1 bit)	Transitive Bit: Set to 1 for optional transitive attributes; 0 for optional non-transitive attributes. Always set to 1 for well-known attributes.																
		Partial	1/8 (1 bit)	Partial Bit: When 1, indicates that information about an optional transitive attribute is "partial". This means that since it was optional and transitive, one or more of the routers that passed the path along did not implement that attribute but was forced to pass it along, so information about it may be missing (not supplied by the routers that didn't recognize it but just passed it along). If 0, means information is complete. This bit has meaning only for optional transitive attributes; for well-known or non-transitive attributes it is 0.																
		Extended Length	1/8 (1 bit)	Extended Length Bit: Set to 1 for long attributes, to indicate that the <i>Attribute Length</i> field is two bytes in size. Normally 0, meaning the <i>Attribute Length</i> field is a single byte.																
Reserved	4/8 (4 bits)	Reserved: Set to zero and ignored.																		
Attribute Type Code	1	<p>Attribute Type Code: A number that identifies the attribute type. Current values are:</p> <table border="1"> <thead> <tr> <th>Value</th> <th>Attribute Type</th> </tr> </thead> <tbody> <tr> <td>1</td> <td><i>Origin</i></td> </tr> <tr> <td>2</td> <td><i>AS_Path</i></td> </tr> <tr> <td>3</td> <td><i>Next_Hop</i></td> </tr> <tr> <td>4</td> <td><i>Multi_Exit_Disc (MED)</i></td> </tr> <tr> <td>5</td> <td><i>Local_Pref</i></td> </tr> <tr> <td>6</td> <td><i>Atomic_Aggregate</i></td> </tr> <tr> <td>7</td> <td><i>Aggregator</i></td> </tr> </tbody> </table>	Value	Attribute Type	1	<i>Origin</i>	2	<i>AS_Path</i>	3	<i>Next_Hop</i>	4	<i>Multi_Exit_Disc (MED)</i>	5	<i>Local_Pref</i>	6	<i>Atomic_Aggregate</i>	7	<i>Aggregator</i>		
		Value	Attribute Type																	
		1	<i>Origin</i>																	
		2	<i>AS_Path</i>																	
		3	<i>Next_Hop</i>																	
		4	<i>Multi_Exit_Disc (MED)</i>																	
		5	<i>Local_Pref</i>																	
		6	<i>Atomic_Aggregate</i>																	
7	<i>Aggregator</i>																			

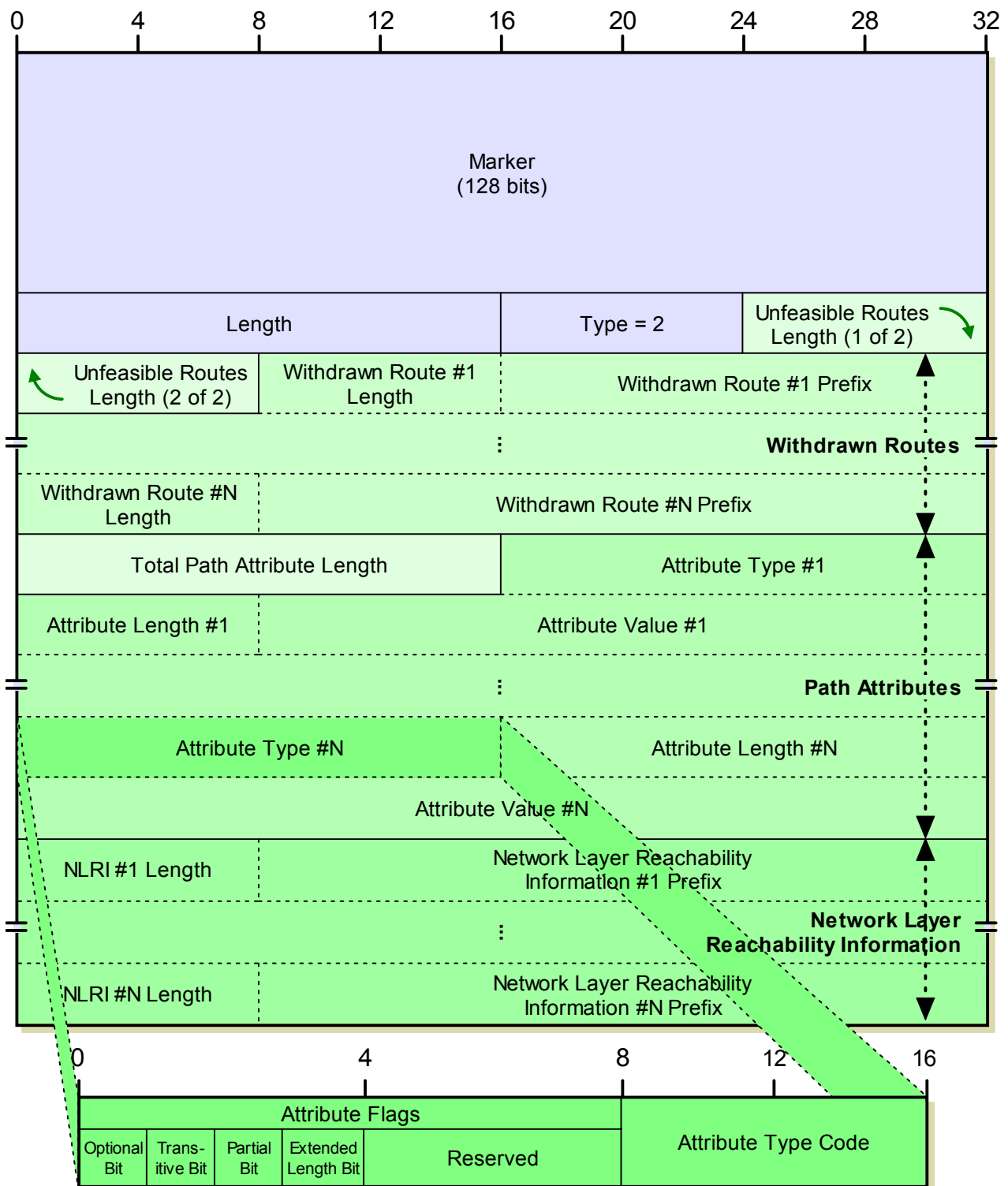

Figure 194: BGP Update Message Format

This diagram shows the complete BGP *Update* message format, including a set of withdrawn routes, path attributes and *NLRI* entries. The exploded view shows the substructure of the *Attribute Type* subfield of *Path Attributes*, as described in [Table 140](#).



Key Concept: The most important message type in BGP is the Update message, which is used to send detailed information about routes between BGP devices. It uses a complex structure that allows a BGP speaker to efficiently specify new routes, update existing ones, and withdraw routes that are no longer valid. Each message may include the full description of one existing route, and may also withdraw from use a list of multiple routes.

BGP Connectivity Maintenance: *Keepalive* Messages

Once a BGP connection is established using *Open* messages, BGP peers will initially use *Update* messages to send each other a large amount of routing information. They will then settle into a routine, where the BGP session is maintained, but *Update* messages are sent only when needed. Since these updates correspond to route changes, and route changes are normally infrequent, this means many seconds may elapse between receipt of consecutive *Update* messages.

The BGP Hold Timer and Keepalive Message Interval

While a BGP peer is waiting to hear the next *Update* message, it remains sort of like a person who has been put “on hold” on the telephone. Now, seconds may not seem like much to us, but to a computer they are a very long time. Like you, a BGP speaker that is put on hold for too long might become impatient, and start to wonder if maybe the other guy hung up on them. Computers don't get offended at being put on hold, but they might wonder if perhaps a problem arose that led to the connection being interrupted.

To keep track of how long it has been on hold, each BGP device maintains a special *hold timer*. This hold timer is set to an initial value each time its peer sends a BGP message. It then counts down until the next message is received, when it is reset. If the hold timer ever expires, the connection is assumed to have been interrupted and the BGP session is terminated.

The length of the hold timer is negotiated as part of session setup using *Open* messages. It must be at least three seconds long, or may be negotiated as a value of zero. If zero, the hold timer is not used; this means the devices are “infinitely patient” and don't care how much time elapses between messages.

To ensure that the timer doesn't expire even when no *Updates* need to be sent for a long while, each peer periodically sends a BGP *Keepalive* message. The name says it all: the message just keeps the BGP connection alive. The rate at which *Keepalive* messages is sent is implementation-dependent, but the standard recommends that they be sent with an interval of one-third the value of the hold timer. So if the hold timer has a value of three seconds, each peer sends a *Keepalive* every second (unless it needs to send some other message type in that second). To prevent excess bandwidth use, *Keepalives* must be sent no more often than once per second, so that is the minimum interval even if the hold timer is shorter than three seconds.

BGP Keepalive Message Format

The point of a *Keepalive* message is the message itself; there's no data to be communicated. In fact, we want to keep the message short and sweet. Thus, it is really a “dummy” message containing only a BGP header—a nice change after that incredibly long *Update* message format! The format of the *Keepalive* message can be found in [Table 141](#) and [Figure 195](#).

Table 141: BGP Keepalive Message Format

Field Name	Size (bytes)	Description
<i>Marker</i>	16	Marker: This large field at the start of each BGP message is used for synchronization and authentication. See the discussion of the BGP general message format for details.
<i>Length</i>	2	Length: The total length of the message in bytes, including the fields of the header. <i>Keepalive</i> messages are fixed in length at 19 bytes.
<i>Type</i>	1	Type: BGP message type, value is 4 for <i>Keepalive</i> messages.

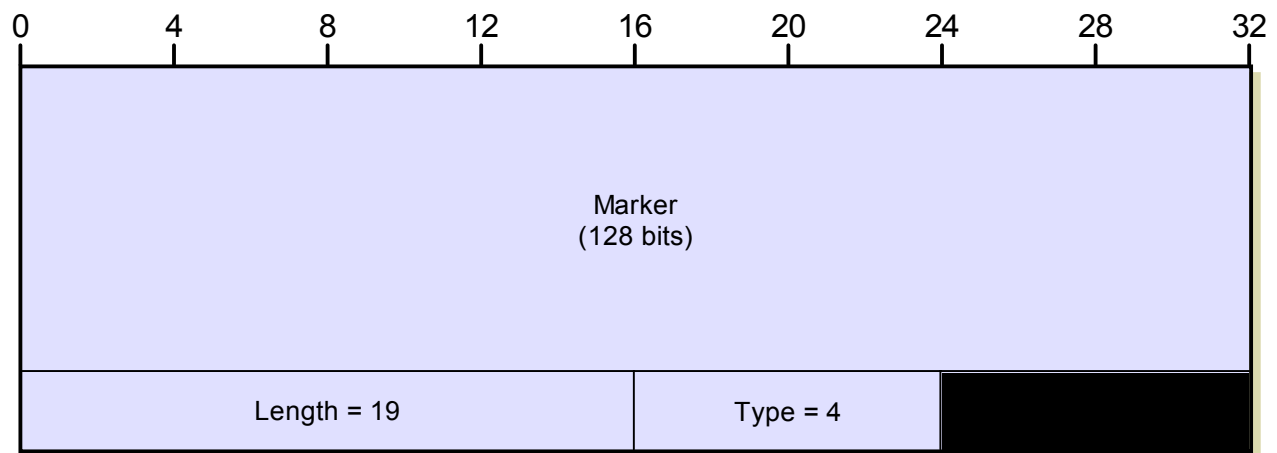

Figure 195: BGP Keepalive Message Format

There is also one other, special use of *Keepalive* messages: as acknowledgment of receipt of a valid *Open* message [during initial BGP session setup](#).



Key Concept: BGP *Keepalive* messages are sent periodically during idle periods when no real information needs to be sent between connected BGP speakers. They serve only to keep the session alive, and thus contain only a BGP header and no data.

BGP Error Reporting: Notification Messages

Once established, a BGP session will remain open for a considerable period of time, allowing routing information to be exchanged between devices on a regular basis. During the course of operation, certain error conditions may crop up that may interfere with normal communication between BGP peers. Some of these are serious enough that the BGP session must be terminated. When this occurs, the device detecting the error will inform its peer of the nature of the problem by sending it a BGP *Notification* message, and then close the connection.

Of course, having someone tell you “I found an error, so I quit” is not of much value. Therefore, the BGP *Notification* message contains a number of fields that provide information about the nature of the error that caused the message to be sent. This includes a set of primary error codes, as well as subcodes within some of these error codes. Depending on the nature of the error, an additional data field may also be included to aid in diagnosing the problem.

In addition to the use of *Notification* messages to convey the occurrence of an error, this message type is also used for other purposes. For example, one may be sent if two devices cannot agree on how to negotiate a session, which isn't, strictly speaking, an error. A *Notification* message is also used to allow a device to tear down a BGP session for reasons having nothing to do with an error.

BGP Notification Message Format

The format for the BGP *Notification* messages is detailed in [Table 142](#) and [Figure 196](#).

Table 142: BGP Notification Message Format

Field Name	Size (bytes)	Description
Marker	16	Marker: This large field at the start of each BGP message is used for synchronization and authentication. See the discussion of the BGP general message format for details.
Length	2	Length: The total length of the message in bytes, including the fields of the header. <i>Notification</i> messages are variable in length.
Type	1	Type: BGP message type, value is 3 for <i>Notification</i> messages.
Error Code	1	Error Code: Specifies the general class of the error. Table 143 shows the possible error types with a brief description of each.
Error Subcode	1	Error Subcode: This field provides more specific indication of the cause of the error for three of the <i>Error Code</i> values. The possible values of this field for each <i>Error Code</i> value are shown in Table 144 .
Data	Variable	Data: This field contains additional information to help diagnose the error; its meaning is dependent on the type of error specified in the <i>Error Code</i> and <i>Error Subcode</i> fields. In most cases, this field is filled in with whatever bad value caused the error to occur. For example, for “Message Header Error / Bad Message Type”, the value of the bad <i>Type</i> field is placed here.

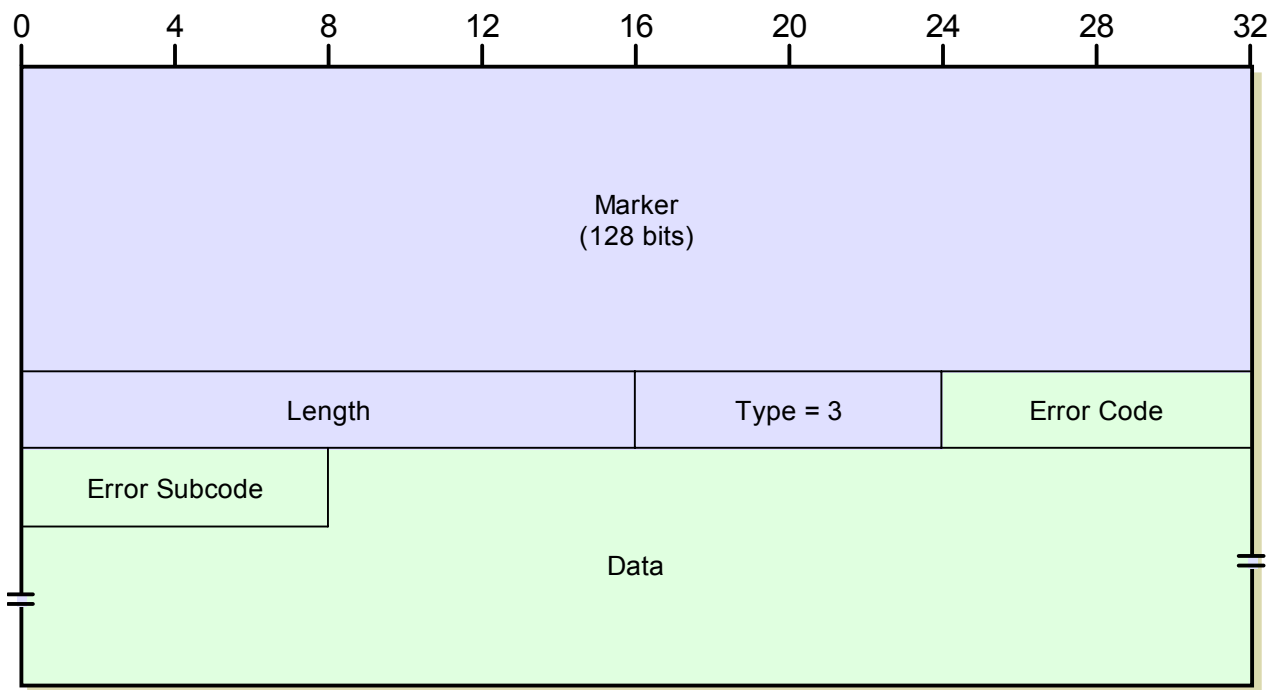

Figure 196: BGP Notification Message Format

BGP Notification Message Error Codes and Error Subcodes

Table 143 and Table 144 show the values permitted for the *Error Code* and *Error Subcode* fields, respectively, and thus provide a good summary of the types of errors that *Notification* messages can report (as well as demonstrating the other non-error uses of the message type).

Table 143: BGP Notification Message Error Codes (Page 1 of 2)

Error Code Value	Code Name	Description
1	Message Header Error	A problem was detected either with the contents or length of the BGP header. The <i>Error Subcode</i> provides more details on the nature of the problem.
2	Open Message Error	A problem was found in the body of an <i>Open</i> message. The <i>Error Subtype</i> field describes the problem in more detail. Note that authentication failures or inability to agree on a parameter such as hold time are included here.
3	Update Message Error	A problem was found in the body of an <i>Update</i> message. Again, the <i>Error Subtype</i> provides more information. Many of the problems that fall under this code are related to issues detected in the routing data or path attributes sent in the <i>Update</i> message, so these messages provide feedback about such problems to the device sending the erroneous data.
4	Hold Timer Expired	A message was not received before the hold time expired. See the description of the Keepalive message for details on this timer.

Table 143: BGP Notification Message Error Codes (Page 2 of 2)

Error Code Value	Code Name	Description
5	Finite State Machine Error	The BGP <i>finite state machine</i> refers to the mechanism by which the BGP software on a peer moves from one operating state to another based on events (see the TCP finite state machine description for some background on this concept). If an event occurs that is unexpected for the state the peer is currently in, it will generate this error.
6	Cease	Used when a BGP device wants to break the connection to a peer for a reason not related to any of the error conditions described by the other codes.

Table 144: BGP Notification Message Error Subcodes (Page 1 of 2)

Error Type	Error Subcode Value	Subcode Name	Description
Message Header Error (Error Code 1)	1	Connection Not Synchronized	The expected value in the <i>Marker</i> field was not found, indicating that the connection has become unsynchronized. See the description of the Marker field .
	2	Bad Message Length	The message was less than 19 bytes, greater than 4096 bytes, or not consistent with what was expected for the message type.
	3	Bad Message Type	The <i>Type</i> field of the message contains an invalid value.
Open Message Error (Error Code 2)	1	Unsupported Version Number	The device does not “speak” the version number its peer is trying to use.
	2	Bad Peer AS	The router doesn't recognize the peer's autonomous system number or is not willing to communicate with it.
	3	Bad BGP Identifier	The BGP <i>Identifier</i> field is invalid.
	4	Unsupported Optional Parameter	The <i>Open</i> message contains an optional parameter that the recipient of the message doesn't understand.
	5	Authentication Failure	The data in the <i>Authentication Information</i> optional parameter could not be authenticated.
	6	Unacceptable Hold Time	The router refuses to open a session because the proposed hold time its peer specified in its <i>Open</i> message is unacceptable.

Table 144: BGP Notification Message Error Subcodes (Page 2 of 2)

Error Type	Error Subcode Value	Subcode Name	Description
Update Message Error (Error Code 3)	1	Malformed Attribute List	The overall structure of the message's path attributes is incorrect, or an attribute has appeared twice.
	2	Unrecognized Well-Known Attribute	One of the mandatory well-known attributes was not recognized.
	3	Missing Well-Known Attribute	One of the mandatory well-known attributes was not specified.
	4	Attribute Flags Error	An attribute has a flag set to a value that conflicts with the attribute's type code.
	5	Attribute Length Error	The length of an attribute is incorrect.
	6	Invalid Origin Attribute	The <i>Origin</i> attribute has an undefined value.
	7	AS Routing Loop	A routing loop was detected.
	8	Invalid Next_Hop Attribute	The <i>Next_Hop</i> attribute is invalid.
	9	Optional Attribute Error	An error was detected in an optional attribute.
	10	Invalid Network Field	The <i>Network Layer Reachability Information</i> field is incorrect.
	11	Malformed AS_Path	The <i>AS_Path</i> attribute is incorrect.

Note that, perhaps ironically, no mechanism exists to report an error in a *Notification* message itself. This is likely because the connection is normally terminated after such a message is sent.



Key Concept: BGP *Notification* messages are used for error reporting between BGP peers. Each message contains an *Error Code* field that indicates what type of problem occurred. For certain *Error Codes*, an *Error Subcode* field provides additional details about the specific nature of the problem. Despite these field names, *Notification* messages are also used for other types of special non-error communication, such as terminating a BGP connection.



TCP/IP Exterior Gateway Protocol (EGP)

Routing in the early Internet was done using a small number of centralized *core* routers that maintained complete information about network reachability on the Internet. They exchanged information using the historical interior routing protocol, the [Gateway-to-Gateway Protocol \(GGP\)](#). Around the periphery of this core were located other *non-core* routers, sometimes standalone and sometimes collected into groups. These exchanged network reachability information with the core routers using the first TCP/IP exterior routing protocol: the *Exterior Gateway Protocol (EGP)*.

History and Development

Like its interior routing counterpart GGP, EGP was developed by Internet pioneers Bolt, Beranek and Newman (BBN) in the early 1980s. It was first formally described in an Internet standard in RFC 827, [Exterior Gateway Protocol \(EGP\)](#), published in October 1982. This draft document was superseded in April 1984 by RFC 904, [Exterior Gateway Protocol Formal Specification](#). Like GGP, EGP is now considered obsolete, having been replaced by the [Border Gateway Protocol \(BGP\)](#). However, also like GGP, it is an important part of the history of TCP/IP routing, so it is worth examining briefly.



Note: As I explained in [the introduction to this overall section on TCP/IP routing protocols](#), routers were in the past often called *gateways*. As such, exterior routing protocols were “exterior gateway protocols”. The EGP protocol discussed here is a specific instance of an exterior gateway protocol, for which the abbreviation is also *EGP*. Thus, you may occasionally see BGP also called an “exterior gateway protocol” or an “EGP”, which is the generic use of this term.

Overview of Operation

EGP is responsible for communication of network reachability information between neighboring routers, which may or may not be in different autonomous systems. The operation of EGP is somewhat similar to that of BGP. Each EGP router maintains a database of information regarding what networks it can reach and how to reach them. It sends this information out on a regular basis to each router to which it is directly connected. Routers receive these messages and update their routing tables, and then use this new information to update other routers. Information about how to reach each network propagates across the entire internetwork.

Routing Information Exchange Process

The actual process of exchanging routing information involves several steps to discover neighbors and then set up and maintain communications. Briefly, the steps are:

-
1. **Neighbor Acquisition:** Each router attempts to establish a connection to each of its neighboring routers by sending *Neighbor Acquisition Request* messages. A neighbor hearing a request can respond with a *Neighbor Acquisition Confirm* to say that it recognized the request and wishes to connect. It may reject the acquisition by replying with a *Neighbor Acquisition Refuse* message. For an EGP connection to be established between a pair of neighbors, each must first successfully acquire the other with a *Confirm* message.
 2. **Neighbor Reachability:** After acquiring a neighbor, a router checks to make sure the neighbor is reachable and functioning properly on a regular basis. This is done by sending an EGP *Hello* message to each neighbor for which a connection has been established. The neighbor replies with an *I Heard You (IHU)* message. These messages are somewhat analogous to the [BGP Keepalive message](#), but are used in matched pairs.
 3. **Network Reachability Update:** A router sends *Poll* messages on a regular basis to each of its neighbors. The neighbor responds with an *Update* message, which contains details about the networks that it is able to reach. This information is used to update the routing tables of the device that sent the *Poll*.

A neighbor can decide to terminate a connection (called *neighbor de-acquisition*) by sending a *Cease* message; the neighbor responds with a *Cease-ack* (acknowledge) message.

As I mentioned earlier, the primary function in the early Internet was to connect peripheral routers or groups of routers to the Internet core. It was therefore designed under the assumption that the internetwork was connected as a hierarchical tree, with the *core* as the root. EGP was not designed to handle an arbitrary topology of autonomous systems like BGP, and cannot guarantee the absence of routing loops if such loops exist in the interconnection of neighboring routers. This is part of why BGP needed to be developed as the Internet moved to a more arbitrary structure of autonomous system connections; it has now entirely replaced EGP.

Error Reporting

An *Error* message is also defined, which is similar to the [BGP Notification message](#) in role and structure. It may be sent by a neighbor in response to receipt of an EGP message either when the message itself has a problem (such as a bad message length or unrecognized data in a field) or to indicate a problem in how the message is being used (such as receipt of *Hello* or *Poll* messages at a rate deemed excessive). Unlike the *BGP Notification* message, an EGP router does not necessarily close the connection when sending an *Error* message.



Key Concept: The *Exterior Gateway Protocol (EGP)* was the first TCP/IP exterior routing protocol and was used with GGP on the early Internet. It functions in a manner similar to BGP: an EGP router makes contact with neighboring routers and exchanges routing information with them. A mechanism is also provided to maintain a session and report errors. EGP is more limited than BGP in capability and is now considered a historical protocol.



TCP/IP Transport Layer Protocols

The first three layers of the [OSI Reference Model](#)—the physical layer, data link layer and network layer—are very important layers for understanding how networks function. The physical layer moves bits over wires; the data link layer moves frames on a network; the network layer moves datagrams on an internetwork. Taken as a whole, they are the parts of a protocol stack that are responsible for the actual “nuts and bolts” of getting data from one place to another.

Immediately above these we have the fourth layer of the OSI Reference Model: the *transport layer*, called the host-to-host transport layer in the [TCP/IP model](#). This layer is interesting in that it resides in the very architectural center of the model. Accordingly, it represents an important transition point between the hardware-associated layers below it that do the “grunt work”, and the layers above that are more software-oriented and abstract.

Protocols running at the transport layer are charged with providing several important services to enable software applications in higher layers to work over an internetwork. They are typically responsible for allowing connections to be established and maintained between software services on possibly distant machines. Perhaps most importantly, they serve as the bridge between the needs of many higher-layer applications to send data in a reliable way without needing to worry about error correction, lost data or flow management, and network-layer protocols, which are often unreliable and unacknowledged. Transport layer protocols are often very tightly-tied to the network layer protocols directly below them, and designed specifically to take care of functions that they do not deal with.

In this section I describe transport layer protocols and related technologies used in the TCP/IP protocol. There are two main protocols at this layer; the Transmission Control Protocol (TCP) and the User Datagram Protocol (UDP). I also discuss how transport-layer addressing is done in TCP/IP in the form of ports and sockets.



Note: It may seem strange that I have only one subsection here, the one that covers TCP and UDP. This is a result of the fact that The TCP/IP Guide is [excerpted from a larger networking reference](#).

Transmission Control Protocol (TCP) and User Datagram Protocol (UDP)

TCP/IP is the most important internetworking protocol suite in the world; it is the basis for the Internet, and the “language” spoken by the vast majority of the world's networked computers. TCP/IP includes a large set of protocols that operate at the network layer and above. The suite as a whole is anchored at layer three by the [Internet Protocol \(IP\)](#), which many people consider the single most important protocol in the world of networking.

Of course, there's a bit of *architectural distance* between the network layer and the applications that run at the layers well above. While IP is the protocol that performs the bulk of the functions needed to make an internetwork, it does not include many capabilities that are needed by applications. In TCP/IP these tasks are performed by a pair of protocols that operate at the transport layer: the *Transmission Control Protocol (TCP)* and the *User Datagram Protocol (UDP)*.

Of these two, TCP gets by far the most attention. It is the transport layer protocol that is most often associated with TCP/IP, and, well, its name is right there, “up in lights”. It is also the transport protocol used for many of the Internet's most popular applications, while UDP gets second billing. However, TCP and UDP are really peers that play the same role in TCP/IP. They function very differently and provide different benefits and drawbacks to the applications that use them, which makes them both important to the protocol suite as a whole. The two protocols also have certain areas of similarity, which makes it most efficient that I describe them in the same overall section, highlighting where they share characteristics and methods of operation, as well as where they diverge.

In this section I provide a detailed examination of the two TCP/IP transport layer protocols: the Transmission Control Protocol (TCP) and the User Datagram Protocol (UDP). I begin with a quick overview of the role of these two protocols in the TCP/IP protocol suite, and a discussion of why they are both important. I describe the method that both protocols employ for addressing, using transport-layer ports and sockets. I then have two detailed sections for each of UDP and TCP. I conclude with a summary quick-glance comparison of the two.

Incidentally, I describe UDP before TCP for a simple reason: it is simpler. UDP operates more like a classical message-based protocol, and in fact is more similar to IP itself than is TCP. This is the same reason why the section on TCP is much larger than that covering UDP: TCP much more complex and does a great deal more than UDP.

TCP and UDP Overview and Role In TCP/IP

The transport layer in a protocol suite is responsible for a specific set of functions. For this reason, one might expect that the TCP/IP suite would have a single main transport protocol to perform those functions, just as it has IP as its core protocol at the network layer. It is a curiosity, then, that there are **two** different widely-used TCP/IP transport layer protocols. This arrangement is probably one of the best examples of [the power of protocol layering](#)—and hence, an illustration that it was worth all the time you spent learning to understand that pesky [OSI Reference Model](#). ☺

Differing Transport Layer Requirements in TCP/IP

Let's start with a look back at layer three. In my [overview of the key operating characteristics of the Internet Protocol](#), I described several important limitations of how IP works. The most important of these are that IP is *connectionless*, *unreliable* and *unacknowledged*. Data is sent over an IP internetwork without first establishing a connection, using a “best effort” paradigm. Messages **usually** get where they need to go, but there are no guarantees, and the sender usually doesn't even know if the data got to its destination.

These characteristics present serious problems to software. Many, if not most, applications need to be able to count on the fact that the data they send will get to its destination without loss or error. They also want the connection between two devices to be automatically managed, with problems such as congestion and flow control taken care of as needed. Unless some mechanism is provided for this at lower layers, every application would need to perform these jobs, which would be a massive duplication of effort.

In fact, one might argue that establishing connections, providing reliability, and handling retransmissions, buffering and data flow is sufficiently important that it would have been best to simply build these abilities directly into the Internet Protocol. Interestingly, that was exactly the case in the early days of TCP/IP. “In the beginning” [there was just a single protocol](#) called “TCP” that combined the tasks of the Internet Protocol with the reliability and session management features just mentioned.

There's a big problem with this, however. Establishing connections, providing a mechanism for reliability, managing flow control and acknowledgments and retransmissions: these all come at a cost: time and bandwidth. Building all of these capabilities into a single protocol that spans layers three and four would mean all applications got the benefits of reliability, but also the costs. While this would be fine for many applications, there are others that both don't need the reliability, and “can't afford” the overhead required to provide it.

The Solution: Two Very Different Transport Protocols

Fixing this problem was simple: let the network layer (IP) take care of basic data movement on the internetwork, and define two protocols at the transport layer. One would provide a rich set of services for those applications that need that functionality, with the understanding that some overhead was required to accomplish it. The other would be simple, providing little in the way of classic layer-four functions, but it would be fast and easy to use. Thus, the result of two TCP/IP transport-layer protocols:

-
- 🕒 **Transmission Control Protocol (TCP):** A full-featured, connection-oriented, reliable transport protocol for TCP/IP applications. TCP provides transport-layer addressing to allow multiple software applications to simultaneously use a single IP address. It allows a pair of devices to establish a virtual connection and then pass data bidirectionally. Transmissions are managed using a special *sliding window* system, with unacknowledged transmissions detected and automatically retransmitted. Additional functionality allows the flow of data between devices to be managed, and special circumstances to be addressed.
 - 🕒 **User Datagram Protocol (UDP):** A very simple transport protocol that provides transport-layer addressing like TCP, but little else. UDP is barely more than a “wrapper” protocol that provides a way for applications to access the Internet Protocol. No connection is established, transmissions are unreliable, and data can be lost.

By means of analogy, TCP is a fully-loaded luxury performance sedan with a chauffeur and a satellite tracking/navigation system. It provides lots of frills and comfort, and good performance. It virtually guarantees you will get where you need to go without any problems, and any concerns that do arise can be corrected. In contrast, UDP is a stripped-down race car. Its goal is simplicity and speed, speed, speed; everything else is secondary. You will probably get where you need to go, but hey, race cars can be finicky to keep operating.



Key Concept: To suit the differing transport requirements of the many TCP/IP applications, two TCP/IP transport layer protocols exist. The *Transmission Control Protocol (TCP)* is a full-featured, connection-oriented protocol that provides acknowledged delivery of data while managing traffic flow and handling issues such as congestion and transmission loss. The *User Datagram Protocol (UDP)*, in contrast, is a much simpler protocol that concentrates only on delivering data, to maximize the speed of communication when the features of TCP are not required.

Applications of TCP and UDP

Having two transport layer protocols with such complementary strengths and weaknesses provides considerable flexibility to the creators of networking software:

- 🕒 **TCP Applications:** Most “typical” applications need the reliability and other services provided by TCP, and don't care about loss of a small amount of performance to overhead. For example, most applications that transfer files or important data between machines use TCP, because loss of any portion of the file renders the entire thing useless. Examples include such well-known applications as the [Hypertext Transfer Protocol \(HTTP\)](#) used by the [World Wide Web \(WWW\)](#), the [File Transfer Protocol \(FTP\)](#) and the [Simple Mail Transfer Protocol \(SMTP\)](#). I describe TCP applications in more detail in the TCP section.
- 🕒 **UDP Applications:** I'm sure you're thinking: “what sort of application doesn't care if its data gets there, and why would I want to use it?” You might be surprised: UDP is used by lots of TCP/IP protocols. UDP is a good match for applications in two circumstances. The first is when the application doesn't really care if some of the data gets lost; streaming video or multimedia is a good example, since one lost byte of data won't even be noticed. The other is when the application itself chooses to provide

some other mechanism to make up for the lack of functionality in UDP. Applications that send very small amounts of data, for example, often use UDP under the assumption that if a request is sent and a reply is not received, the client will just send a new request later on. This provides enough reliability without the overhead of a TCP connection. [I discuss some common UDP applications in the UDP section.](#)



Key Concept: Most classical applications, especially ones that send files or messages, require that data be delivered reliably, and therefore use TCP for transport. Applications using UDP are usually those where loss of a small amount of data is not a concern, or that use their own application-specific procedures for dealing with potential delivery problems that TCP handles more generally.

In the next few sections we'll first examine the common transport layer addressing scheme used by TCP and UDP, and then look at each of the two protocols in detail. Following these sections is a [summary comparison](#) to help you see at a glance where the differences lie between TCP and UDP. Incidentally, if you want a good “real-world” illustration of why having both UDP and TCP is valuable, consider [message transport under the Domain Name System \(DNS\)](#), which actually uses UDP for certain types of communication and TCP for others.

Before leaving the subject of comparing UDP and TCP, I want to explicitly point out that even though TCP is often described as being *slower* than UDP, this is a **relative** measurement. TCP is a very well-written protocol that is capable of highly efficient data transfers. It is only slow compared to UDP because of the overhead of establishing and managing connections. The difference can be significant, but is not enormous, so keep that in mind.



TCP/IP Transport Layer Protocol (TCP and UDP) Addressing: Ports and Sockets

Internet Protocol (IP) addresses are the universally-used main form of addressing on a TCP/IP network. These [network-layer addresses](#) uniquely identify each network interface, and as such, serve as the mechanism by which data is routed to the correct network on the internetwork, and then the correct device on that network. What some people don't realize, however, is that there is an additional level of addressing that occurs at the transport layer in TCP/IP, above that of the IP address. Both of the TCP/IP transport protocols, TCP and UDP, use the concepts of *ports* and *sockets* for virtual software addressing, to enable the function of many applications simultaneously on an IP device.

In this section I describe the special mechanism used for addressing in both TCP and UDP. I begin with a discussion of TCP/IP application processes, including the client/server nature of communication, which provides a background for explaining how ports and sockets are used. I then give an overview of the concept of ports, and how they enable the multiplexing of data over an IP address. I describe the way that port numbers are categorized in ranges, and assigned to server processes for common applications. I explain the concept of ephemeral port numbers used for clients. I then discuss sockets and their use for connection identification, including the means by which multiple devices can talk to a single port on another device. I then provide a summary table of the most common well-known and registered port numbers.

TCP/IP Processes, Multiplexing and Client/Server Application Roles

I believe the most sensible place to start learning about how the TCP/IP protocol suite works is by examining the [Internet Protocol \(IP\)](#) itself, and the support protocols that function in tandem with it at the network layer. IP is the foundation upon which most of the rest of TCP/IP is built. It is the mechanism by which data is packaged and routed throughout a TCP/IP internetwork.

It makes sense, then, that when we examine the operation of TCP/IP from the perspective of the Internet Protocol, we talk very generically about sending and receiving datagrams. To the IP layer software that sends and received IP datagrams, the higher-level application they come from and go to is really unimportant: to IP, "a datagram is a datagram", pretty much. All datagrams are packaged and routed in the same way, and IP is mainly concerned with lower-level aspects of moving them between devices in an efficient manner.

It's important to remember, however, that this is really an ***abstraction***, for the convenience of describing layer three operation. It doesn't consider how datagrams are really generated and used above layer three. [Layer four represents a transition point](#) between the OSI model hardware-related layers (one, two and three) and the software-related layers (five to seven). This means the TCP/IP transport layer protocols, TCP and UDP, **do** need to pay attention to the way that software uses TCP/IP, even if IP really does not.

Ultimately, the entire point of having networks, internetworks and protocols suites like TCP/IP is to enable networking *applications*. Most Internet users employ these applications on a daily basis. In fact, most of us will be running many different applications simultaneously. For example, you might be using a [World Wide Web](#) browser to check the news, an [FTP](#) client to upload some pictures to share with family, and an [Internet Relay Chat](#) program to discuss something with a friend or colleague. In fact, it is common to have multiple *instances* of a single application. The most common example is having multiple Web browser windows open (I sometimes find myself with as many as 30 going at one time!)

Multiplexing and Demultiplexing

Most communication in TCP/IP takes the form of exchanges of information between a program running on one device, and a matching program on another device. Each instance of an application represents a copy of that application software that needs to send and receive information. These application instances are commonly called *processes*. A TCP/IP application process is any piece of networking software that sends and receives information using the TCP/IP protocol suite. This includes both “classic” end-user applications such as the ones described above, as well as support protocols that behave as applications when they send messages. Examples of the latter would include a network management protocol like [SNMP](#), or even the routing protocol [BGP](#) (which sends messages using TCP like an application does).

So, a typical TCP/IP host has multiple processes each needing to send and receive datagrams. All of them, however, must be sent using the same interface to the internetwork, using the IP layer. This means that the data from all applications (with some possible exceptions) is “funneled down”, initially to the transport layer, where it is handled by either TCP or UDP. From there, messages pass to the device's IP layer, where they are packaged in IP datagrams and sent out over the internetwork to different destinations. The technical term for this is *multiplexing*. This term simply means combining, and its use here is a software analog to the way it is done with signals.

A complementary mechanism is responsible for receipt of datagrams. At the same time that the IP layer multiplexes datagrams from many application processes to be sent out, it receives many datagrams that are intended for different processes. The IP layer must take this stream of unrelated datagrams, and eventually pass them to the correct process (through the transport layer protocol above it). This is the reverse of multiplexing: *demultiplexing*. You can see an illustration of the basic concept behind TCP/IP process multiplexing and demultiplexing in [Figure 197](#).



Key Concept: TCP/IP is designed to allow many different applications to send and receive data simultaneously using the same Internet Protocol software on a given device. To accomplish this it is necessary to *multiplex* transmitted data from many sources as it is passed down to the IP layer. As a stream of IP datagrams is received, it is *demultiplexed* and the appropriate data passed to each application software instance on the receiving host.

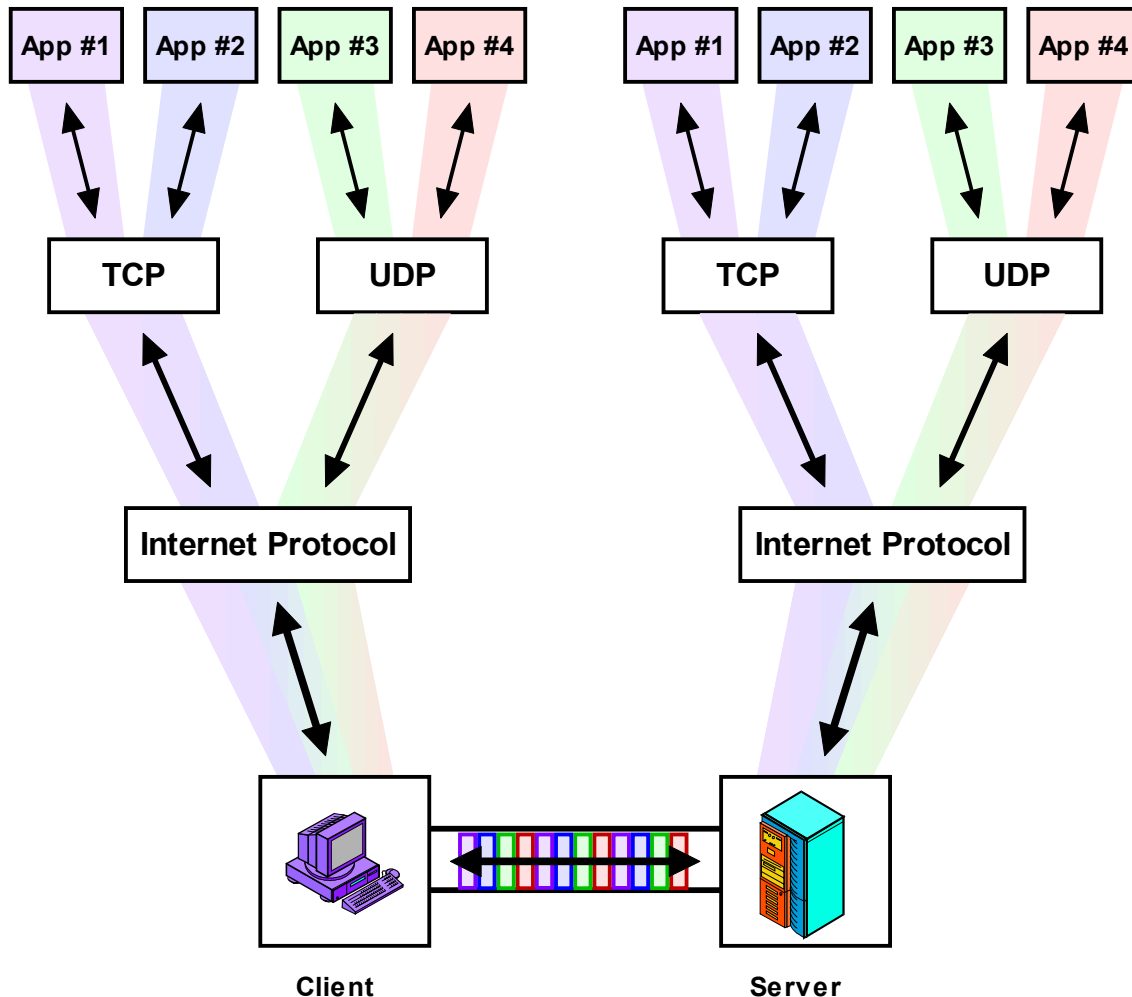

Figure 197: Process Multiplexing and Demultiplexing In TCP/IP

In a typical machine running TCP/IP there are many different protocols and applications running simultaneously. This example shows four different applications communicating between a client and server machine. All four are multiplexed for transmission using the same IP software and physical connection; received data is demultiplexed and passed to the appropriate application. IP, TCP and UDP provide the means of keeping distinct the data from each application.

TCP/IP Client Processes and Server Processes

There's another characteristic of TCP/IP software that is very important to understanding how the transport layer and higher layers of the suite operate: it is generally *asymmetric*. This means that when a TCP/IP application process on one computer tries to talk to an application process on another computer, the two processes are usually not exactly the same. They are instead *complements* of each other, designed to function together as a team.

As I explained in the [overview description of TCP/IP](#), most networking applications use a *client/server* model of operation. This term can be used to refer to the roles of computers, where a server is a relatively powerful machine that provides services to a large number of

user-operated clients. It also applies to software. In this context, a *client process* is usually one that runs on a client machine and initiates contact to perform some sort of function. A *server process* usually runs on a hardware server, and listens for requests from clients and responds to them.

The classic example of this is, of course, the World Wide Web. [The WWW uses the Hypertext Transfer Protocol \(HTTP\)](#), a good example of an application protocol. A Web browser is an HTTP client, normally running on an end-user client machine such as you are probably using at this moment. It initiates an exchange of HTTP (Web) data by sending a request to a Web (HTTP) server. A server process on that Web server hears the request and replies either with the requested item(s)—a Web page or other data—or an error message. The server is usually specifically designed to handle many incoming client requests, and in many cases for little else.

Okay, I can practically see the impatient look on your face as you wonder to yourself: “why is he telling me all of this in a section that is supposed to explain TCP and UDP ports”? The answers will become clear shortly, I promise. I started here because the fact that many application processes run simultaneously and have their data multiplexed for transmission is the impetus for why higher-level addressing is a necessity in TCP/IP. The client/server arrangement used by TCP/IP has an important impact on the way that ports are used and the mechanisms for how they are assigned. The next two topics explore these concepts more completely.

TCP/IP Ports: Transport Layer (TCP/UDP) Addressing

A typical host on a TCP/IP internetwork has many different software application processes running concurrently. Each generates data that it sends to either TCP or UDP, which in turn passes it to IP for transmission. This [multiplexed stream of datagrams](#) is sent out by the IP layer to various destinations. Simultaneously, each device's IP layer is receiving datagrams that originated in numerous application processes on other hosts. These need to be demultiplexed, so they end up at the correct process on the device that receives them.

Multiplexing and Demultiplexing Using Ports

The question is: how do we demultiplex a sequence of IP datagrams that need to go to many different application processes? Let's consider a particular host with a single network interface bearing the IP address 24.156.79.20. Normally, every datagram received by the IP layer will have this value in the IP *Destination Address* field. Consecutive datagrams received by IP may contain a piece of a file you are downloading with your Web browser, an e-mail sent to you by your brother, and a line of text a buddy wrote in an IRC chat channel. How does the IP layer know which datagrams go where, if they all have the same IP address?

The first part of the answer lies in the *Protocol* field included in the header of each IP datagram. This field carries a code that identifies the protocol that sent the data in the datagram to IP. Since most end-user applications use TCP or UDP at the transport layer, the *Protocol* field in a received datagram tells IP to pass data to either TCP or UDP as appropriate.

Of course, this just defers the problem to the transport layer: both TCP and UDP are used by many applications at once. This means TCP or UDP must figure out which process to send the data to. To make this possible, an additional addressing element is necessary. This address allows a more specific location—a software process—to be identified within a particular IP address. In TCP/IP, this transport layer address is called a *port*.



Key Concept: TCP/IP transport layer addressing is accomplished using TCP and UDP *ports*. Each port number within a particular IP device identifies a particular software process.

Source Port and Destination Port Numbers

In both UDP and TCP messages two addressing fields appear, for a *Source Port* and a *Destination Port*. These are analogous to [the fields for source address and destination address at the IP level](#), but at a higher level of detail. They identify the originating process on the source machine, and the destination process on the destination machine. They are filled in by the TCP or UDP software before transmission, and used to direct the data to the correct process on the destination device.

TCP and UDP port numbers are 16 bits in length, so valid port numbers can theoretically take on values from 0 to 65,535. [As we will see in the next topic](#), these values are divided into ranges for different purposes, with certain ports reserved for particular uses.

One fact that is sometimes a bit confusing is that both UDP and TCP use the same range of port numbers, and they are independent. So, in theory, it is possible for UDP port number 77 to refer to one application process and TCP port number 77 to refer to an entirely different one. There is no ambiguity, at least to the computers, because as mentioned above, each IP datagram contains a *Protocol* field that specifies whether it is carrying a TCP message or a UDP message. IP passes the datagram to either TCP or UDP, which then sends the message on to the right process using the port number in the TCP or UDP header. This mechanism is illustrated in [Figure 198](#).

In practice, having TCP and UDP use different port numbers is confusing, especially for the reserved port numbers used by common applications. For this reason, by convention, most reserved port numbers are reserved for both TCP and UDP. For example, port #80 is reserved for the Hypertext Transfer Protocol (HTTP) for both TCP and UDP, even though HTTP only uses TCP. [We'll examine this in greater detail in the next topic](#).

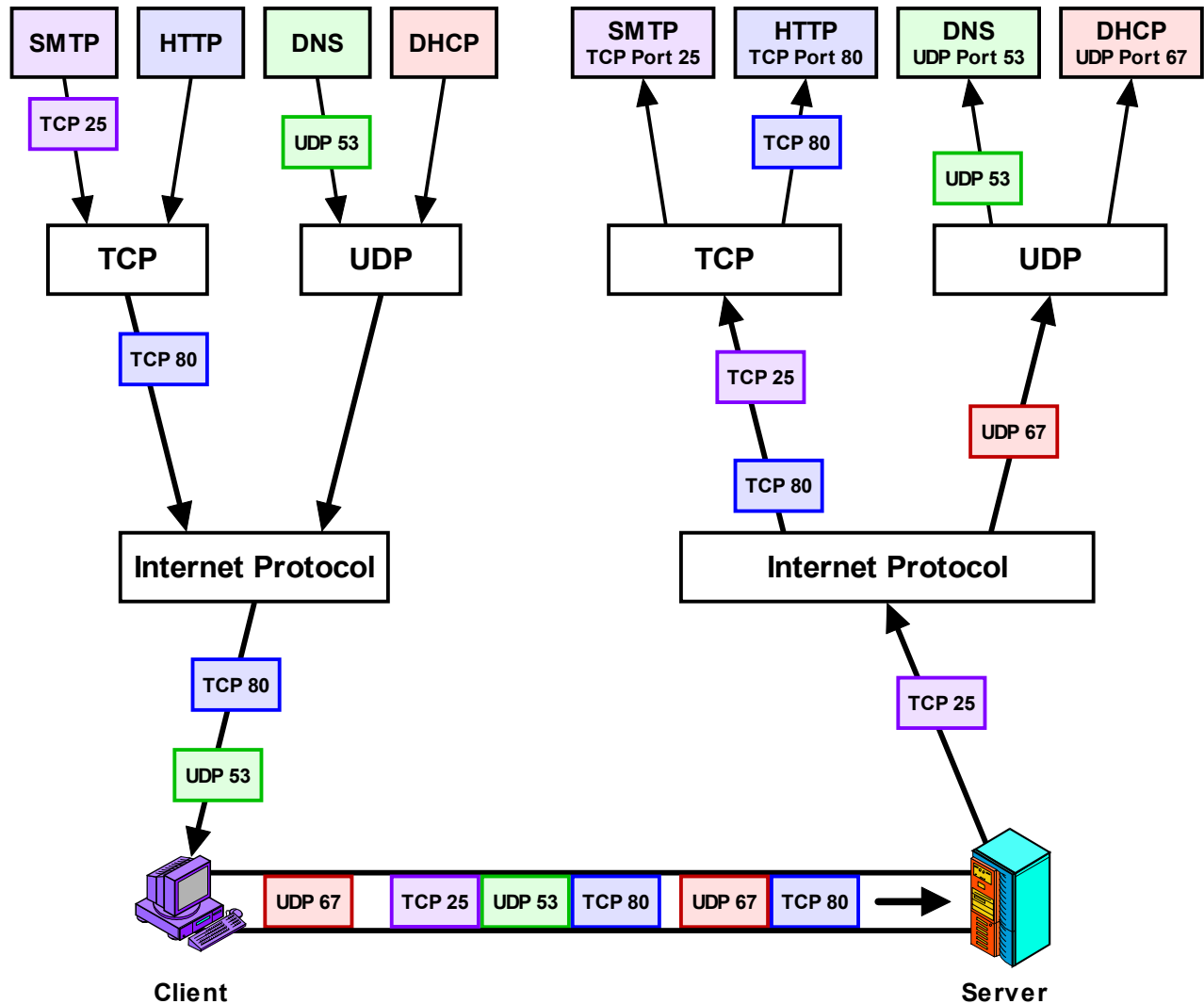

Figure 198: TCP/IP Process Multiplexing/Demultiplexing Using TCP/UDP Ports

This is a more “concrete” version of [Figure 197](#), showing how TCP and UDP ports are used to accomplish software multiplexing and demultiplexing. Again here there are four different TCP/IP applications communicating, but this time I am showing only the traffic going from the client to the server. Two of the applications are using TCP and two UDP. Each application on the client sends messages using a specific TCP or UDP port number. These port numbers are used by the server’s UDP and TCP software to pass the datagrams to the appropriate application process.

Summary of Port Use for Datagram Transmission and Reception

So, to summarize, here’s the basics of how transport-layer addressing (port addressing) works in TCP and UDP:

-
- ④ **Sending Datagrams:** An application specifies the source and destination port it wishes to use for the communication. These are encoded into the TCP or UDP header, depending on which transport layer protocol the application is using. When TCP or UDP passes data to IP, IP indicates the protocol type appropriate for TCP or UDP in the *Protocol* field of the IP datagram. The source and destination port numbers are encapsulated as part of the TCP or UDP message, within the IP datagram's data area.
 - ④ **Receiving Datagrams:** The IP software receives the datagram, inspects the *Protocol* field and decides to which protocol the datagram belongs (in this case, TCP or UDP, but of course there are other protocols that use IP directly, such as ICMP). TCP or UDP receives the datagram and passes its contents to the appropriate process based on the destination port number.



Key Concept: Application process multiplexing and demultiplexing in TCP/IP is implemented using the IP *Protocol* field and the UDP/TCP *Source Port* and *Destination Port* fields. Upon transmission, the *Protocol* field is given a number to indicate whether TCP or UDP was used, and the port numbers are filled in to indicate the sending and receiving software process. The device receiving the datagram uses the *Protocol* field to determine whether TCP or UDP was used, and then passes the data to the software process indicated by the *Destination Port* number.



Note: As an aside, I should point out that the term *port* has many meanings aside from this one in TCP/IP. For example, a physical outlet in a network device is often called a *port*. Usually one can discern whether the “port” in question refers to a hardware port or a software port from context, but you may wish to watch out for this.

TCP/IP Application Assignments and Server Port Number Ranges: Well-Known, Registered and Dynamic/Private Ports

The [port numbers we discussed in the previous topic](#) provide a method of transport-layer addressing that allows many applications to use TCP and UDP simultaneously. By specifying the appropriate destination port number, an application sending data can be sure that the right process on the destination device will receive the message. Unfortunately, there's still a problem we have to work on before this addressing system will work.

The Problem: Identifying Particular Processes on A Server

To explain it, I need to go back to a familiar example: using the World Wide Web. We fire up our Web browser, which is client software that sends requests using the [Hypertext Transfer Protocol \(HTTP\)](#). We need to either know the IP address of the Web site we want to access, or we may have the IP address supplied to us automatically using [DNS](#). Once we have the address, the Web browser can generate an HTTP message and send it to the Web site's IP address.

This HTTP message is being sent not “just anywhere” on that IP address: it is intended for the Web server process on the site we are trying to reach. The problem is: how does the Web browser (client process) know which port number has been assigned to the server process on the Web site? Port numbers can range from 0 to 65,535, which means a lot of choices. And in theory, every Web site could assign a different port number to its Web server process.

The Solution: Reserved Port Numbers

There are a couple of different ways to resolve this problem. TCP/IP takes what is probably the simplest possible approach: it *reserves* certain port numbers for particular applications. Each common application has a specific port number that is assigned to it for use by server processes that listen for requests for that application and then respond to them. To avoid chaos, the software that implements a particular server process normally uses the same reserved port number on every IP device, so clients can find it easily.

In our example, the reserved port number for HTTP is 80. Every Web browser just “knows” that Web sites are designed to listen for requests sent to port 80. They will thus use this value in requests, to ensure the IP and TCP software on the Web browser direct these HTTP messages to the Web server software. [It is possible for a particular Web server to use a different port number](#), but in this case, the user of the Web browser must be informed of this number somehow, and must explicitly tell the Web browser to use it instead of the default port number (80).



Key Concept: To allow client devices to more easily establish connections to TCP/IP servers, server processes for common applications use universal server port numbers that clients are pre-programmed to know to use by default.

TCP/UDP Port Number Ranges

For this system to work well, universal agreement on port assignments is essential. Thus, this becomes another situation where a central authority is needed to manage a list of port assignments that everyone uses. For TCP/IP, it is the same authority responsible for the assignment and coordination of other centrally-managed numbers, including IP addresses, IP *Protocol* numbers and so forth: the [Internet Assigned Numbers Authority \(IANA\)](#).

As we have seen, there are 65,536 port numbers that can be used for processes. But there are also a fairly large number of TCP/IP applications, and the list grows every year. IANA needs to carefully manage the port number “address space” to ensure that port numbers are not wasted on protocols that won’t be widely used, while also providing flexibility for organizations that need to make use of obscure applications. To this end, the full spectrum of TCP and UDP port numbers is divided into three ranges, as shown in [Table 145](#).

The existence of these ranges ensures that there will be universal agreement on how to access a server process for the most common TCP/IP protocols, while also allowing flexibility for special applications. Most of the TCP/IP applications and application protocols use

numbers in the well-known port number range for their servers. These port numbers are not generally used for client processes, but there are some exceptions. For example, port 68 is reserved for a client using the [Bootstrap Protocol \(BOOTP\)](#) or [Dynamic Host Configuration Protocol \(DHCP\)](#).

Table 145: TCP and UDP Port Number Ranges

Port Range Name	Port Number Range	Description
Well-Known (Privileged) Port Numbers	0 to 1,023	<p>These port numbers are managed by IANA and reserved for only the most universal TCP/IP applications. The IANA assigns these port numbers only to protocols that have been standardized using the TCP/IP RFC process, that are in the process of being standardized, or that are likely to be standardized in the future.</p> <p>On most computers, these port numbers are used only by server processes run by system administrators or privileged users. These generally correspond to processes that implement key IP applications, such as Web servers, FTP servers and the like. For this reason, these are sometimes called <i>system port numbers</i>.</p>
Registered (User) Port Numbers	1,024 to 49,151	<p>There are many applications that need to use TCP/IP but are not specified in RFCs, or are not so universally used that they warrant a worldwide well-known port number. To ensure that these various applications do not conflict with each other, IANA uses the bulk of the overall port number range for registered port numbers. Anyone who creates a viable TCP/IP server application can request to reserve one of these port numbers, and if approved, the IANA will register that port number and assign it to the application.</p> <p>These port numbers are generally accessible by any user on a system and are therefore sometimes called <i>user port numbers</i>.</p>
Private/Dynamic Port Numbers	49,152 to 65,535	<p>These ports are neither reserved nor maintained by IANA. They can be used for any purpose without registration, so they are appropriate for a private protocol used only by a particular organization</p>



Key Concept: Port numbers assignments are managed by IANA to ensure universal compatibility around the global Internet. The numbers are divided into three ranges: *well-known* port numbers used for the most common applications, *registered* port numbers for other applications, and *private/dynamic* port numbers that can be used without IANA registration.

TCP/IP Client (Ephemeral) Ports and Client/Server Application Port Use

The significance of the asymmetry between clients and servers in TCP/IP becomes evident when we examine in detail how port numbers are used. Since clients initiate application data transfers using TCP and UDP, it is they that need to know the port number of the

server process. Consequently, it is servers that are required to use universally-known port numbers. Thus, [well-known and registered port numbers](#) identify server processes. They are used as the destination port number in requests sent by clients.

In contrast, servers respond to clients; they do not initiate contact with them. Thus, the client doesn't need to use a reserved port number. In fact, this is really an understatement: a server **shouldn't** use a well-known or registered port number to send responses back to clients. The reason is that it is possible for a particular device to have both client and server software of the same protocol running on the same machine. If a server received an HTTP request on port 80 of its machine and sent the reply back to port 80 on the client machine, it would be sending the reply to the client machine's HTTP **server** process (if present) and not the client process that sent the initial request.

To know where to send the reply, the server must know the port number the client is using. This is supplied by the client as the *Source Port* in the request, and then used by the server as the destination port to send the reply. Client processes don't use well-known or registered ports. Instead, each client process is assigned a temporary port number for its use. This is commonly called an *ephemeral port number*.



Note: Your \$10 word for the day: *ephemeral*: “short-lived; existing or continuing for a short time only.” — Webster's Revised Unabridged Dictionary.

Ephemeral Port Number Assignment

Ephemeral port numbers are assigned as needed to processes by the TCP/IP software. Obviously, each client process running concurrently needs to use a unique ephemeral port number, so the TCP and UDP layers must keep track of which are in use. These port numbers are generally assigned in a *pseudo-random* manner from a reserved pool of numbers. I say “pseudo-random” because there is no specific meaning to an ephemeral port number assigned to a process, so a random one could be selected for each client process. However, since it is necessary to reuse the port numbers in this pool over time, many implementations use a set of rules to minimize the chance of confusion due to reuse.

Consider a client process that just used ephemeral port number 4,121 to send a request, received a reply, and then terminated. Suppose we immediately reallocate 4,121 to some other process. However, the server accessed by the prior user of port 4,121 for some reason sent an extra reply. It would go to the new process, creating confusion. To avoid this, it is wise to wait as long as possible before reusing port number 4,121 for another client process. Some implementations will therefore cycle through the port numbers in to ensure the maximum amount of time elapses between consecutive uses of the same ephemeral port number.



Key Concept: Well-known and registered port numbers are needed for server processes since a client must know the server's port number to initiate contact. In contrast, client processes can use any port number. Each time a client process initiates a UDP or TCP communication it is assigned a temporary, or *ephemeral*, port number to use for that conversation. These port numbers are assigned in a pseudo-random way, since the exact number used is not important, as long as each process has a different number.

Ephemeral Port Number Ranges

The range of port numbers that is used for ephemeral ports on a device also depends on the implementation. The "classic" ephemeral port range was established by the TCP/IP implementation in BSD (Berkeley Standard Distribution) UNIX, where it was defined as 1,024 to 4,999, providing 3,976 ephemeral ports. This seems like a very large number, and it is indeed usually more than enough for a typical client. However, the size of this number can be deceiving. Many applications use more than one process, and it is theoretically possible to run out of ephemeral port numbers on a very busy IP device. For this reason, most of the time the ephemeral port number range can be changed. The default range may be different for other operating systems.

Just as well-known and registered port numbers are used for server processes, ephemeral port numbers are for client processes only. This means that the use of a range of addresses from 1,024 to 4,999 does not conflict with the use of that same range for registered port numbers as seen in the previous topic.

Port Number Use During a Client/Server Exchange

So, let's return to the matter of client/server application message exchange. Once assigned an ephemeral port number, it is used as the source port in the client's request TCP/UDP message. The server receives the request, and then generates a reply. In forming this response message, it *swaps* the source and destination port numbers, just as it does the source and destination IP addresses. So, the server's reply is sent **from** the well-known or registered port number on the server process, back **to** the ephemeral port number on the client machine.

Phew, confusing... quick, back to our example! ☺ Our Web browser, with IP address 177.41.72.6 wants to send an HTTP request to a particular Web site at IP address 41.199.222.3. The HTTP request is sent using TCP, with a *Destination Port* number of 80 (the one reserved for HTTP servers). The *Source Port* number is allocated from a pool of ephemeral ports; let's say it's port 3,022. When the HTTP request arrives at the Web server it is conveyed to port 80 where the HTTP server receives it. That process generates a reply, and sends it back to 177.41.72.6, using *Destination Port* 3,022 and *Source Port* 80. The two processes can exchange information back and forth; each time the source port number and destination port number are swapped along with the source and destination IP addresses. This example is illustrated in [Figure 199](#).

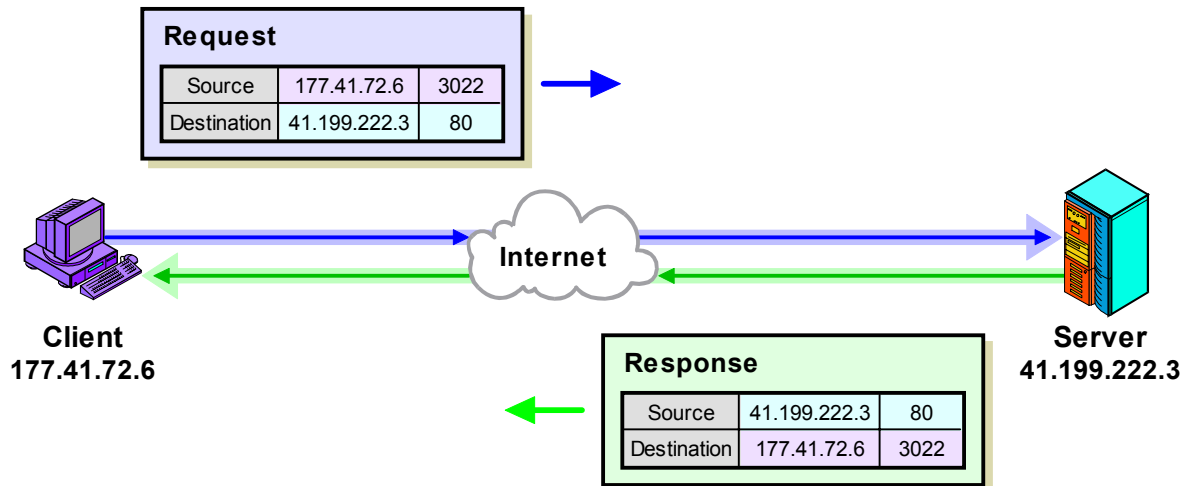

Figure 199: TCP/IP Client/Server Application Port Mechanics

This highly simplified example shows how clients and servers use port numbers for a request-reply exchange. The client is making an HTTP request and sends it to the server at HTTP's well-known port number, 80. Its port number for this exchange is the pseudo-randomly-selected 3,022. The server sends its reply back to that port number, which it reads from the request.



Key Concept: In most TCP/IP client/server communications, the client uses a random ephemeral port number and sends a request to the appropriate reserved port number at the server's IP address. The server sends its reply back to whatever port number it finds in the *Source Port* field of the request.

TCP/IP Sockets and Socket Pairs: Process and Connection Identification

The preceding topics have illustrated the key difference between addressing at the level of the Internet Protocol, and addressing as it is seen by application processes. To summarize, at layer three, an IP address is all that is really important for properly transmitting data between IP devices. In contrast, application protocols must be concerned with [the port assigned to each instance of the application](#), so they can properly use TCP or UDP.

Sockets: Process Identification

What this all means is that the overall identification of an application process actually uses the **combination** of the IP address of the host it runs on—or the network interface over which it is talking, to be more precise—and the port number which has been assigned to it. This combined address is called a *socket*. Sockets are specified using the following notation:

<IP Address>:<Port Number>

So, for example, if we have a Web site running on IP address 41.199.222.3, the socket corresponding to the HTTP server for that site would be *41.199.222.3:80*.



Key Concept: The overall identifier of a TCP/IP application process on a device is the combination of its IP address and port number, which is called a *socket*.

You will also sometimes see a socket specified using a host name instead of an IP address, like this:

<Host Name>:<Port Number>

To use this descriptor, the name must first be resolved to an IP address using DNS. For example, you might find a Web site URL like this: “http://www.thisisagreatsite.com:8080”. This tells the Web browser to first *resolve* the name “www.thisisagreatsite.com” to an IP address using [DNS](#), and then send a request to that address using the non-standard server port 8080, which is occasionally used instead of port 80 since it resembles it. ([See the discussion of application layer addressing using URLs for much more.](#))

The *socket* is a very fundamental concept to the operation of TCP/IP application software. In fact, it is the basis for an important TCP/IP application program interface (API) with the same name: *sockets*. A version of this API for Windows is called *Windows Sockets* or *WinSock*, which you may have heard of before. These APIs allow application programs to easily use TCP/IP to communicate.

Socket Pairs: Connection Identification

So, the exchange of data between a pair of devices consists of a series of messages sent from a socket on one device to a socket on the other. Each device will normally have multiple such simultaneous conversations going on. In the case of [TCP](#), a connection is established for each pair of devices for the duration of the communication session. These connections must be managed, and this requires that they be uniquely identified. This is done using the pair of socket identifiers for each of the two devices that are connected.



Key Concept: Each device may have multiple TCP connections active at any given time. Each connection is uniquely identified using the combination of the client socket and server socket, which in turn contains four elements: the client IP address and port, and the server IP address and port.

Let's return to the example we used in the previous topic ([Figure 199](#)). We are sending an HTTP request from our client at 177.41.72.6 to the Web site at 41.199.222.3. The server for that Web site will use well-known port number 80, so its socket is 41.199.222.3:80, as we saw before. We have been ephemeral port number 3,022 for our Web browser, so the client socket is 177.41.72.6:3022. The overall connection between these devices can be described using this socket pair:

(41.199.222.3:80, 177.41.72.6:3022)

For much more on how TCP identifies connections, see [the topic on TCP ports and connection identification](#) in the section on TCP fundamentals.

Unlike TCP, UDP is a connectionless protocol, so it obviously doesn't use connections. The pair of sockets on the sending and receiving devices can still be used to identify the two processes exchanging data, but since there are no connections the socket pair doesn't have the significance that it does in TCP.

Common TCP/IP Applications and Assigned Well-Known and Registered Port Numbers

The great popularity of the TCP/IP protocol suite has led to the development of literally thousands of different applications and protocols. Most of these use the client/server model of operation that we discussed earlier in this section. Server processes for a particular application are designed to use a particular [reserved port number](#), with clients using an [ephemeral \(temporary\) port number](#) to initiate a connection to the server.

Management of Reserved Port Numbers

To ensure that everyone agrees on which port numbers server applications for each application should use, they are centrally managed by the [Internet Assigned Numbers Authority \(IANA\)](#). Originally, IANA kept the list of well-known and registered port numbers in a lengthy text document, along with all the many other parameters for which IANA was centrally responsible (such as IP *Protocol* field numbers, [Type and Code field values for ICMP](#), and so on). These were published on a periodic basis in Internet (RFC) standards documents titled [Assigned Numbers](#).

This system worked fine in the early days of the Internet, but by the mid-1990s, these values were changing so rapidly that using the RFC process was not feasible. It was too much work to keep publishing them, and the RFC was practically out of date the day after it was put out.

The last [Assigned Numbers](#) standard was RFC 1700, published in October 1994. After that time, IANA moved to a set of World Wide Web documents containing the parameters they manage. This allowed IANA to keep the lists constantly up to date, and for TCP/IP users to be able to get more current information. RFC 1700 was officially obsoleted in 2002.



On The Web: Complete information on all the parameters maintained by IANA can be found at <http://www.iana.org/numbers.html>. The URL of the file containing TCP/UDP port assignments is <http://www.iana.org/assignments/port-numbers>.

The document mentioned above is the definitive list of all well-known and registered TCP and UDP port assignments. Each port number is assigned a short *keyword*, with a brief description of the protocol that uses it. There are two problems with this document. The first is that it is incredibly **long**: over 10,000 lines of text. Most of the protocols mentioned in

those thousands of lines are for obscure applications that you have probably never heard of before (I certainly have never heard of most of them!) This makes it hard to easily see the port assignments for the protocols that are most commonly used.

The other problem with this document is that it shows the same port number as reserved for both TCP and UDP for an application. [As I mentioned earlier](#), TCP and UDP port numbers are actually independent, so one could in theory assign TCP port 80 to one server application type and UDP port 80 to another. It was believed that this would lead to confusion, so with very few exceptions, the same port number is shown in the list for the same application for both TCP and UDP. This makes sense, but showing this in the list has a drawback: you can't tell which protocol the application actually uses, and which has just been reserved for consistency.

Given all that, I've decided to include a couple of summary tables here that show the well-known and registered port numbers for the most common TCP/IP applications, and indicated whether the protocol uses TCP, UDP or both.

Common Well-Known Port Numbers and Applications

[Table 146](#) lists the well-known port numbers for the most common TCP/IP application protocols.

Table 146: Common TCP/IP Well-Known Port Numbers and Applications (Page 1 of 2)

Port #	TCP / UDP	Keyword	Protocol Abbreviation	Application or Protocol Name / Comments
7	TCP + UDP	echo	—	Echo Protocol
9	TCP + UDP	discard	—	Discard Protocol
11	TCP + UDP	systat	—	Active Users Protocol
13	TCP + UDP	daytime	—	Daytime Protocol
17	TCP + UDP	qotd	QOTD	Quote Of The Day Protocol
19	TCP + UDP	chargen	—	Character Generator Protocol
20	TCP	ftp-data	FTP (data)	File Transfer Protocol (default data port)
21	TCP	ftp	FTP (control)	File Transfer Protocol (control / commands)
23	TCP	telnet	—	Telnet Protocol
25	TCP	smtp	SMTP	Simple Mail Transfer Protocol
37	TCP + UDP	time	—	Time Protocol
43	TCP	nickname	—	Whois Protocol (also called "Nickname")
53	TCP + UDP	domain	DNS	Domain Name Server (Domain Name System)
67	UDP	bootps	BOOTP / DHCP	Bootstrap Protocol / Dynamic Host Configuration Protocol (Server)

Table 146: Common TCP/IP Well-Known Port Numbers and Applications (Page 2 of 2)

Port #	TCP / UDP	Keyword	Protocol Abbreviation	Application or Protocol Name / Comments
68	UDP	bootpc	BOOTP / DHCP	Bootstrap Protocol / Dynamic Host Configuration Protocol (Client)
69	UDP	tftp	TFTP	Trivial File Transfer Protocol
70	TCP	gopher	—	Gopher Protocol
79	TCP	finger	—	Finger User Information Protocol
80	TCP	http	HTTP	Hypertext Transfer Protocol (World Wide Web)
110	TCP	pop3	POP	Post Office Protocol (version 3)
119	TCP	nntp	NNTP	Network News Transfer Protocol
123	UDP	ntp	NTP	Network Time Protocol
137	TCP + UDP	netbios-ns	—	NetBIOS (Name Service)
138	UDP	netbios-dgm	—	NetBIOS (Datagram Service)
139	TCP	netbios-ssn	—	NetBIOS (Session Service)
143	TCP	imap	IMAP	Internet Message Access Protocol
161	UDP	snmp	SNMP	Simple Network Management Protocol
162	UDP	snmptrap	SNMP	Simple Network Management Protocol (Trap)
179	TCP	bgp	BGP	Border Gateway Protocol
194	TCP	irc	IRC	Internet Relay Chat
443	TCP	https	HTTP over SSL	Hypertext Transfer Protocol over Secure Sockets Layer
500	UDP	isakmp	IKE	IPSec Internet Key Exchange
520	UDP	router	RIP	Routing Information Protocol (RIP-1 and RIP-2)
521	UDP	ripng	RIPng	Routing Information Protocol - "Next Generation"

Common Registered Port Numbers and Applications

The registered port numbers are by definition for protocols that are not standardized using the RFC process, so they are mostly esoteric applications that I don't feel there is much point in listing at length. [Table 147](#) shows a few that I feel are of particular interest:

Table 147: Common TCP/IP Registered Port Numbers and Applications

Port #	TCP / UDP	Keyword	Protocol Abbreviation	Application or Protocol Name / Comments
1512	TCP + UDP	wins	WINS	Microsoft Windows Internet Naming Service
1701	UDP	l2tp	L2TP	Layer Two Tunneling Protocol

Table 147: Common TCP/IP Registered Port Numbers and Applications

Port #	TCP / UDP	Keyword	Protocol Abbreviation	Application or Protocol Name / Comments
1723	TCP	pptp	PPTP	Point-To-Point Tunneling Protocol
2049	TCP + UDP	nfs	NFS	Network File System
6000 - 6063	TCP	x11	X11	X Window System



TCP/IP User Datagram Protocol (UDP)

The very fact that the TCP/IP protocol suite bears the name of the [Internet Protocol](#) and the [Transmission Control Protocol](#) suggests that these are the two key protocols in the suite: IP at the network layer and TCP at the transport layer. It's no wonder, therefore, that many people don't even realize that there *is* a second transport layer protocol in TCP/IP. Like a shy younger brother, the *User Datagram Protocol (UDP)* sits in the shadows while TCP gets the glory. Its fancier sibling deserves much of this limelight, since TCP is arguably the more important of the two transport layer protocol. However, UDP itself fills a critical niche in the TCP/IP protocol suite, allowing many applications to work at their best when using TCP would be less than ideal.

In this section I describe the simpler and lesser-known TCP/IP transport protocol: the User Datagram Protocol (UDP). I begin with an overview of the protocol and a discussion of its history and standards. I outline how UDP operates, and describe the format used for UDP messages. I conclude with a discussion of what sorts of applications use UDP, and the well-known or registered ports that are assigned to them.



Note: There is also a protocol that is part of the NetBIOS/NetBEUI protocol suite called the User Datagram Protocol, also abbreviated UDP. The two are of course not the same.

UDP Overview, History and Standards

I suppose the “sibling rivalry” analogy I drew in the introduction to this section may be a little bit silly. I highly doubt that protocols lie awake at night worrying about how much we use them. ☺ However, it's interesting to discover just how important the User Datagram Protocol (UDP) really is, given how little attention it gets compared to the Transmission Control Protocol (TCP). In fact, in true older-sibling, spotlight-stealing fashion, we can't even really understand the history of UDP without first discussing TCP.

In [the topic that describes the history of TCP/IP](#), I explained that very early on in the development of the protocol suite, there was only one protocol that handled the functions now performed by both IP and TCP. This protocol, itself called TCP, provided network-layer connectivity like IP, and also established connections, provided reliability and took care of the typical transport-layer “quality” requirements as flow control and retransmission handling that we associate with modern TCP.

It didn't take long before the developers of the fledgling combined protocol quickly realized that mixing these functions together was a mistake. While *most* conventional applications needed the classic transport-layer reliability functions, some did not. These features introduced overhead, which would have to be endured even by the applications where reliability features were not needed at all. Worse, there were some applications where the features were not only of no value, but actually a detriment, since even the small amount of lost performance due to the overhead would be a problem.

The solution was to separate the original protocol into IP and TCP. Basic internetworking was to be done by IP, and the reliability features by TCP. This paved the way for the creation of an alternative transport-layer protocol for applications that didn't want or need the features provided by TCP. This, of course, is the *User Datagram Protocol (UDP)*.

There are two main attributes that come up again and again when describing UDP: *simple* and *fast*. It is a **simple** protocol that uses a very straight-forward messaging structure that is similar to the message format used by many other TCP/IP protocols (in contrast to the more complex data structures—[streams and segments](#)—used by TCP). In fact, when you boil it down, the only real goal of the protocol is to serve as an interface between networking application processes running at the higher layers, and the internetworking capabilities of IP. Like TCP, UDP layers on top of IP a method of [transport-layer addressing \(and hence, process identification\) through the use of UDP port numbers](#). It does include an optional checksum capability for error-detection, but adds virtually no other functionality.

In fact, the best way to see for yourself the simplicity of UDP is to look at the standards that define it. Or rather, I should say **standard** in the singular, because there is only one. UDP was defined in RFC 768, [User Datagram Protocol](#), in 1980. This document is all of three pages in length, and has never needed to be revised.

UDP is a **fast** protocol specifically because it doesn't have all the bells and whistles of TCP. This makes it unsuitable for use by many, if not most, typical networking applications. But for some applications, this is exactly what they want from a transport layer protocol: something that takes their data and quickly shuffles it down to the IP layer with a minimum of fuss. In choosing to use UDP, the application writer takes it upon himself or herself to take care of issues such as reliability and retransmissions, if they are needed. This can be a recipe for success or failure, depending on the application and how carefully UDP is used.



Key Concept: The User Datagram Protocol (UDP) was developed for use by application protocols that do not require reliability, acknowledgment or flow control features at the transport layer. It is designed to be simple and fact, providing only transport layer addressing in the form of UDP ports and an optional checksum capability, and little else.

UDP Operation

Uh... Uh... After all these pages, I almost find myself at a loss for words. (Hey, don't skip to the next topic, I said *almost!*) The simplicity of the User Datagram Protocol means that there is not a great deal to say in describing its operation. It is designed to do as little as possible, and little is exactly what it does.

What UDP Does

UDP's only real task is to take data from higher-layer protocols and place it in UDP messages, which are then passed down to the Internet Protocol for transmission. The basic steps for transmission using UDP are:

1. **Higher-Layer Data Transfer:** An application sends a message to the UDP software.
2. **UDP Message Encapsulation:** The higher-layer message is encapsulated into the *Data* field of a UDP message. The headers of the UDP message are filled in, including the *Source Port* of the application that sent the data to UDP, and the *Destination Port* of the intended recipient. The checksum value may also be calculated.
3. **Transfer Message To IP:** The UDP message is passed to IP for transmission.

And that's about it. Of course, on reception at the destination device this short procedure is reversed.

What UDP Does Not

In fact, UDP is **so** simple, that its operation is very often described in terms of what it does **not** do, instead of what it does. As a transport protocol, some of the most important things UDP does not do include the following:

- ☉ UDP does not establish connections before sending data. It just packages it and... off it goes.
- ☉ UDP does not provide acknowledgments to show that data was received.
- ☉ UDP does not provide any guarantees that its messages will arrive.
- ☉ UDP does not detect lost messages and retransmit them.
- ☉ UDP does not ensure that data is received in the same order that they were sent.
- ☉ UDP does not provide any mechanism to manage the flow of data between devices, or handle congestion.



Key Concept: The User Datagram Protocol (UDP) is probably the simplest in all of TCP/IP. All it does is take application layer data passed to it, package it in a simplified message format, and send it to IP for transmission.

If these characteristics sound similar to how I described [the limitations of IP](#), you're paying attention. UDP is basically just IP with transport-layer port addressing. (It is for this reason that UDP is sometimes called a “wrapper” protocol, since all it does is wrap application data in its simple message format and send it to IP.)

I should point out that despite the list above, there are a couple of limited feedback and error checking mechanisms that do exist within UDP. One is the optional checksum capability, which can allow detection of an error in transmission or the situation where a UDP message is delivered to the wrong place; [see the next topic for details](#). The other is [ICMP error reporting](#). For example, if a UDP message is sent that contains a destination

port number not recognized by the destination device, this will lead to the destination host sending an ICMP *Destination Unreachable* message back to the original source. Of course, ICMP exists for all IP errors of this sort, so I'm stretching a bit here; this isn't really part of UDP.

UDP Message Format

What's the magic word when it comes to UDP? Right, *simple*. This is true of the operation of the protocol, and it is also true of the format used for UDP messages. Interestingly, however, it is here that we will actually encounter probably the only aspect of UDP that is *not* simple. I bet that got you interested, huh? Okay, well, it was a worth a try. 😊

In keeping with the goal of efficiency, the UDP header is only eight bytes in length; this contrasts with the [TCP header size of 20 bytes or more](#). [Table 148](#) and [Figure 200](#) show the format of UDP messages.

Table 148: UDP Message Format

Field Name	Size (bytes)	Description
Source Port	2	Source Port: The 16-bit port number of the process that originated the UDP message on the source device. This will normally be an ephemeral (client) port number for a request sent by a client to a server, or a well-known/registered (server) port number for a reply sent by a server to a client. See the section describing port numbers for details .
Destination Port	2	Destination Port: The 16-bit port number of the process that is the ultimate intended recipient of the message on the destination device. This will usually be a well-known/registered (server) port number for a client request, or an ephemeral (client) port number for a server reply. Again, see the section describing port numbers for details .
Length	2	Length: The length of the entire UDP datagram, including both header and <i>Data</i> fields.
Checksum	2	Checksum: An optional 16-bit checksum computed over the entire UDP datagram plus a special "pseudo header" of fields. See below for more information.
Data	Variable	Data: The encapsulated higher-layer message to be sent.

The Checksum Field and the UDP Pseudo Header

The UDP *Checksum* field is the one area where the protocol actually is a bit confusing. The concept of a checksum itself is nothing new; they are used widely in networking protocols to provide protection against errors. What's a bit odd is this notion of computing the checksum over the regular datagram and also a *pseudo header*. What this means is that instead of calculating the checksum over just the fields in the UDP datagram itself, the UDP software first constructs a "fake" additional header that contains the following fields ([Figure 201](#)):

- ☉ The IP *Source Address* field.
- ☉ The IP *Destination Address* field.

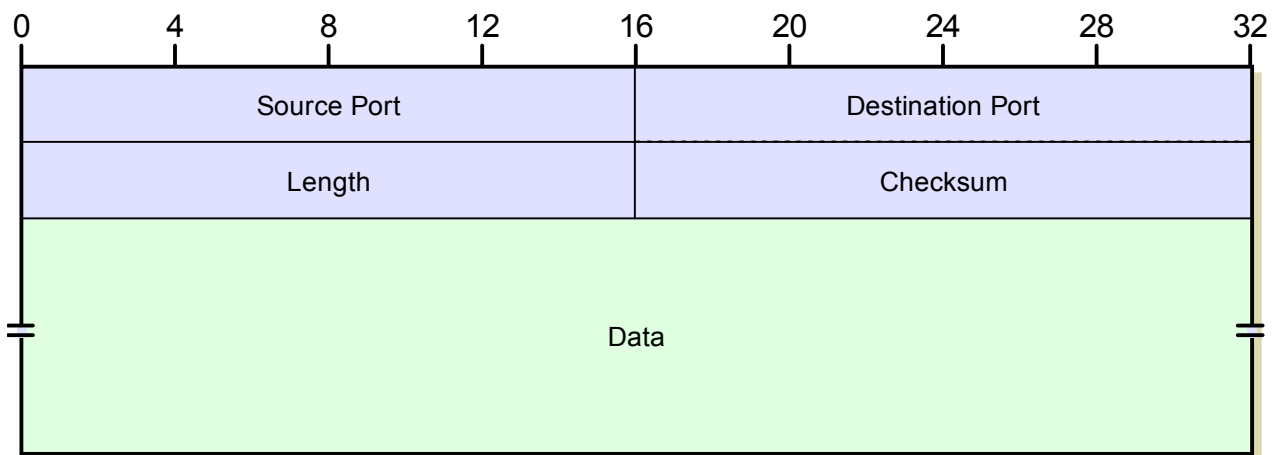

Figure 200: UDP Message Format

- ☉ The IP *Protocol* field.
- ☉ The UDP *Length* field.

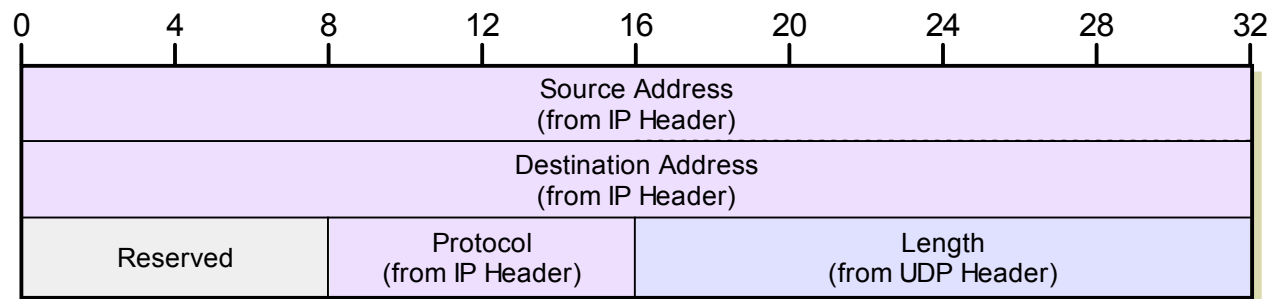

Figure 201: UDP Pseudo Header Format

The total length of this “pseudo header” is 11 bytes. It is padded to 12 bytes with a byte of zeroes and then prepended to the real UDP message. The checksum is then computed over the combination of the pseudo header and the real UDP message, and the value is placed into the *Checksum* field. The pseudo header is used only for this calculation and is then discarded; it is not actually transmitted. The UDP software in the destination device creates the same pseudo header when calculating its checksum to compare to the one transmitted in the UDP header.

Computing the checksum over the regular UDP fields protects against bit errors in the UDP message itself. Adding the pseudo header allows the checksum to also protect against other types of problems as well, most notably the accidental delivery of a message to the wrong destination. The checksum calculation in UDP, including the use of the pseudo header is exactly the same as the method used in TCP (except the *Length* field is different

in TCP). [See the topic describing TCP checksum calculation](#) for a full description of why the pseudo header is important, and some of the interesting implications of using IP fields in transport layer datagram calculations.



Key Concept: UDP packages application layer data into a very simple message format that includes only four header fields. One of these is an optional checksum field; when used, the checksum is computed over both the real header and a “pseudo header” of fields from the UDP and IP headers, in a manner very similar to how the TCP checksum is calculated.

Note that the use of the *Checksum* field is optional in UDP. If it is not used, it is set to a value of all zeroes. This could potentially create confusion, however, since when the checksum *is* used, the calculation can sometimes result in a value of zero. To avoid having the destination think the checksum was not used in this case, this zero value is instead represented as a value of all ones (65,535 decimal).

UDP Common Applications and Server Port Assignments

As we have seen in our exploration of the User Datagram Protocol, UDP contains very little functionality. With the exception of the important addressing capability that UDP ports represent, using UDP is very much like using IP directly. This means [UDP has most of the same disadvantages that IP has](#). It doesn't establish a lasting connection between devices; it doesn't acknowledge received data or retransmit lost messages, and it certainly doesn't concern itself with esoterics such as [flow control and congestion management](#).

The lack of these features makes UDP simply unsuitable for the majority of “classical” networking applications. These usually need to be able to establish a connection, so the two devices can exchange data back and forth. Many also need the ability to occasionally or even regularly send very large amounts of data that must be received intact for it to be of value. For example, consider a message transfer protocol like HTTP. If only part of a Web page gets from a server back to a Web browser, it's useless. HTTP and other [file and message transfer protocols](#) like it need the capabilities we mentioned just above.

I have read about problems that have occurred in the past in applications using UDP. Sometimes programmers don't realize how little UDP does, and that it leaves the application responsible for handling all the potential vagaries of an internetworking environment. Someone writing a UDP-based application must *always* keep in mind that no assumptions can be made about how or even whether any message will be received by its destination, and must plan accordingly. Insufficient testing can lead to disaster in worst-case scenarios on a larger internet and especially, the Internet.

Why Some TCP/IP Applications Use UDP

What applications use UDP then? Well, the classic “disclaimer” with UDP is that since it doesn't provide the features we saw earlier, an application that uses UDP is responsible for those functions. In reality, if an application needs the features that TCP provides but UDP does not, having the application implement them is inefficient, except in special cases. If the application needs what TCP provides, it should just use TCP! However, applications that only need **some** of what TCP implements are sometimes better off to use UDP and implement that limited set of functionality at the application level.

So, the applications that run over UDP are normally those that do **not** require all or even most of the features that TCP has, and that can benefit from the increased efficiency of avoiding the setup and overhead associated with TCP. Applications usually (but not always) meet this description because the data they send falls into one of two categories.

Data Where Performance Is More Important Than Completeness

The classic example of this category is a multimedia application. If you are streaming a video clip over the Internet, the most important thing is that the stream starts flowing quickly and keeps flowing. Humans only really notice significant disruptions in the flow of this type of information, so a few bytes of data missing due to a lost datagram is not only not a big problem, it's unlikely to even be noticed.

Furthermore, even if TCP were used for something like this and a lost datagram was noticed and retransmitted, it would be useless because it would belong to a part of the clip that is long past—and the time spent in that retransmission might make the actual *current* part of the clip arrive late. Clearly, UDP is best for this situation.

Data Exchanges That Are “Short And Sweet”

There are many TCP/IP applications where the underlying protocol consists of only a very simple request/reply exchange. A short request message is sent from a client to a server, and a short reply message goes back from the server to the client. In this situation, there is no real need to set up a connection like TCP does. Also, if only one short message is sent, it can be carried in a single IP datagram. This means there is no need to worry about data arriving out of order, flow control between the devices and so forth.

How about loss of the request or the reply? These can be handled simply at the application level using timers. If a client sends a request and the server doesn't get it, it won't reply, and the client will eventually send a replacement request. The same logic applies if the server sends a response that never arrives.

Other Cases Where UDP Is Required

As I said before, these are the most common cases where UDP is used, but there are other reasons. For example, if an application needs to multicast or broadcast data, it must use UDP, because TCP is only supported for unicast communication between two devices.



Key Concept: UDP is most often used by a protocol instead of TCP in two situations. The first is when an application values timely delivery over reliable delivery, and where TCP's retransmission of lost data would be of limited or even no value.

The second is when a simple protocol is able to handle the potential loss of an IP datagram itself at the application layer using a timer/retransmit strategy, and where the other features of TCP are not required. UDP is also used for applications that require multicast or broadcast transmissions, since these are not supported by TCP.

Common UDP Applications and Server Port Use

Table 149 shows some of the more interesting protocols that use UDP and the well-known and registered port numbers used for each one's server processes. It also provides a very brief description of why these protocols use UDP instead of TCP. See the sections or topics devoted to each application for more details:

Table 149: Common UDP Applications and Server Port Assignments (Page 1 of 2)

Port #	Keyword	Protocol	Comments
53	domain	Domain Name Server (DNS)	Uses a simple request/reply messaging system for most exchanges (but also uses TCP for longer ones).
67 and 68	bootps / bootpc	Bootstrap Protocol (BOOTP) and Dynamic Host Configuration Protocol (DHCP)	Host configuration protocols that consist of short request and reply exchanges.
69	tftp	Trivial File Transfer Protocol (TFTP)	TFTP is a great example of a protocol that was specifically designed for UDP, especially when it is compared to regular FTP. The latter protocol uses TCP to establish a session between two devices, and then makes use of its own large command set and TCP's features to ensure reliable transfer of possibly very large files. In contrast, TFTP is designed for the quick and easy transfer of small files. It includes simple versions of some of TCP's features, such as acknowledgments, to avoid file corruption.
161 and 162	snmp	Simple Network Management Protocol	An administrative protocol that uses relatively short messages.

Table 149: Common UDP Applications and Server Port Assignments (Page 2 of 2)

Port #	Keyword	Protocol	Comments
520 and 521	router / ripng	Routing Information Protocol (RIP-1, RIP-2, RIPng)	Unlike more complex routing protocols like BGP, RIP uses a simple request/reply messaging system, doesn't require connections, and does require multi-casts/broadcasts. This makes it a natural choice for UDP. If a routing update is sent due to a request and is lost, it can be replaced by sending a new request. Routine (unsolicited) updates that are lost are replaced in the next cycle.
2049	nfs	Network File System	NFS is an interesting case. Since it is a file sharing protocol, one would think that it would use TCP instead of UDP, but it was originally designed to use UDP for performance reasons. There were many people who felt this was not the best design decision, and later versions moved to the use of TCP. The latest version of NFS uses only TCP.

Applications That Use Both UDP and TCP

There are some protocols that actually use both UDP **and** TCP. This is often the case either for utility protocols that are designed to accept connection using both transport layer protocols, or for applications that need the benefits of TCP in some cases, but not others.

The classic example of the latter is [DNS](#), which normally uses UDP port 53 for simple requests and replies, which are usually short. Larger messages requiring reliable delivery, such as [zone transfers](#), use TCP port 53 instead. Note that in the table above I have omitted some of the less-significant protocols, such as the ones used for diagnostic purposes (Echo, Discard, CharGen, etc.) For a full list of all common applications, [see the topic on common TCP/IP applications and port numbers](#).



TCP/IP Transmission Control Protocol (TCP)

In my [description of the Internet Protocol](#), I call it the “workhorse” of the TCP/IP protocol suite. IP is, in fact, the foundation upon which the other protocols of the suite are built. Well, if IP is the “workhorse”, then the “worker” that rides on that horse would have to be the TCP/ *IP Transmission Control Protocol (TCP)*. Like horse and rider, TCP and IP form a team that work together to make it possible for applications to easily run over an internetwork.

TCP and IP share the marquee in the name of the suite, and are very important complements to each other. IP concerns itself with classic network-layer tasks such as addressing, datagram packaging and routing, which provide basic internetworking capabilities. TCP provides to applications a method of easily making use of IP, while filling in the capabilities that IP lacks. It allows TCP/IP devices to establish and manage connections and send data reliably, and takes care of handling all the potential “gotchas” that can occur during transmission so each application doesn't need to worry about such matters. To applications, TCP could thus be considered almost like a nice *user interface* to the fairly rudimentary capabilities of IP.

This section provides a comprehensive description of the concepts, characteristics and functions of the Transmission Control Protocol (TCP). TCP is a rather complex protocol that includes a number of sophisticated functions to ensure that applications function in the potentially difficult environment of a large internetwork. It's also, as I said above, a very important part of the TCP/IP protocol suite. For this reason, the section is rather large, and has been divided into five subsections.

The first subsection provides an overview of TCP, describing its history, what it does and how it works. The second paints some important background information that is necessary to understanding how TCP operates. This is done by explaining key concepts such as streams and segments, sliding windows and TCP ports and connections. The third subsection describes the process used by TCP to establish, maintain and terminate sessions. The fourth describes TCP messages, and how they are formatted and transferred. Finally, the last subsection shows how TCP provides reliability and other important transport layer functions to applications, such as flow control, retransmission of lost data and congestion avoidance.



Background Information: Since TCP is built on top of IP, in describing TCP, I make the assumption that the reader has at least a basic familiarity with IP. If you have come to this section without first gaining an understanding of IP, I'd suggest [reading that section first](#). Since it's large, reviewing [the portion describing IP concepts](#) will likely suffice for background.

TCP Overview, Functions and Characteristics

As I mentioned in the previous [section overview](#), the Transmission Control Protocol (TCP) is a critically important part of the TCP/IP suite. It's also a fairly complicated protocol, with a lot of important concepts and mechanisms to understand. The old joke says the best way to eat an elephant is “one bite at a time”. Similarly here, we can best comprehend the operation of this complicated protocol by going slowly, starting with a high-level look at it, where it came from, and what it does in general terms.

In this section I begin our look at TCP with an introduction to the protocol. I first provide an overview and history of TCP, and describe the standards that define it. I then give a “bird's eye” view of TCP by describing it in two important ways. I illustrate what TCP actually does by listing its functions, and then explain how TCP works by describing its most important characteristics. This will give you a feel for what TCP is all about, and hopefully set the stage for the more complex technical discussions in subsequent sections.

TCP Overview, History and Standards

Between them, layers three and four of the [OSI Reference Model](#) represent the interface between networking software (the applications that need to move data across networks) and networking hardware (the devices that carry the data over networks). Any protocol suite must have a protocol or set of protocols that handles these layer three and layer four functions.

The TCP/IP protocol suite is named for the two main protocols that provides these capabilities, allowing software to run on an internetwork: the Transmission Control Protocol (TCP) and the Internet Protocol (IP). IP deals with internetwork datagram delivery and routing, while TCP handles connections and provides reliability. What's interesting, however, is that in the early days of the protocol suite, there was, in fact, no “TCP/IP” at all.

TCP History

Due to its prominent role, the history of TCP is impossible to describe without going back to the early days of the protocol suite as a whole. In the early 1970s, what we know of today as the global Internet was a small research internetwork called the *ARPANet*, named for the United States *Defense Advanced Research Projects Agency* (*DARPA* or *ARPA*). This network used a technology called the *Network Control Protocol* (*NCP*) to allow hosts to connect to each other. NCP did approximately the jobs that TCP and IP do together today.

Due to limitations in the NCP, development began on a new protocol that would be better suited to a growing internetwork. This new protocol, first formalized in RFC 675, was called the *Internet Transmission Control Program* (*TCP*). Like its predecessor NCP, TCP was responsible for basically everything that was needed to allow applications to run on an internetwork. Thus, TCP was at first both TCP and IP.

As I explain in detail in [the topic describing the history of TCP/IP as a whole](#), several years were spent adjusting and revising TCP, with version 2 of the protocol documented in 1977. While the functionality of TCP was steadily improved, there was a problem with the basic

concept behind the protocol. Having TCP by itself handle both datagram transmissions and routing (layer three functions) as well as connections, reliability and data flow management (layer four functions) meant that TCP violated key concepts of protocol layering and modularity. TCP forced all applications to use the layer four functions in order to use the layer three functions. This made TCP inflexible, and poorly-suited to the needs of applications that only need the lower-level functions and not the higher-level ones.

As a result, the decision was made to split TCP into two: the layer four functions were retained, with TCP renamed the Transmission Control **Protocol** (as opposed to *Program*). The layer three functions became the Internet Protocol. This split was finalized in version 4 of TCP, and so the first IP was given “version 4” as well, for consistency. Version 4 of TCP was defined in RFC 793, *Transmission Control Protocol*, published September 1981, and is still the current version of the standard.

Even though it is more than 20 years old and is the first version most people have ever used, version 4 was the result of several years work and many earlier TCP versions tested on the early Internet. It is therefore a very mature protocol for its age. A *precocious* protocol, you could say. (To be fair, many additional features and modifications to how TCP works have been described in other standards, rather than upgrading the main document.)

Overview of TCP Characteristics and Operation

TCP is a full-featured transport layer protocol that provides all the functions needed by a typical application for the reliable transportation of data across an arbitrary internetwork. It provides transport-layer addressing for application processes in the form of [TCP ports](#), and allows these ports to be used in establishing connections between machines. Once connections have been created, data can be passed bidirectionally between two devices. Applications can send data to TCP as a simple [stream of bytes](#), and TCP takes care of packaging and sending the data as *segments* that are packaged into IP datagrams. The receiving device's TCP implementation reverses the process, passing up to the application the stream of data originally sent.

TCP includes an extensive set of mechanisms to ensure that data gets from source to destination reliably, consistently and in a timely fashion. The key to its operation in this regard is the [sliding window acknowledgement system](#), which allows each device to keep track of which bytes of data have been sent and to confirm receipt of data received from the other device in the connection. Unacknowledged data is eventually [retransmitted automatically](#), and the parameters of the system can be adjusted to the needs of the devices and the connection. This same system also provides buffering and [flow control capabilities](#) between devices, to handle uneven data delivery rates and other problems.

The inclusion of so many capabilities in TCP maximizes the likelihood that just about any application requiring connection-oriented reliable data delivery will be satisfied by the protocol. This is a primary goal of TCP, as it means that higher-layer applications don't individually have to provide these common functions. TCP is the most widely used TCP/IP transport protocol, employed by the majority of conventional message-passing applications.



Key Concept: The primary transport layer protocol in the TCP/IP suite is the *Transmission Control Protocol (TCP)*. TCP is a connection-oriented, acknowledged, reliable, fully-featured protocol designed to provide applications with a reliable way to send data using the unreliable Internet Protocol. It allows applications to send bytes of data as a *stream* of bytes, and automatically packages them into appropriately-sized *segments* for transmission. It uses a special *sliding window acknowledgment system* to ensure that all data is received by its recipient, to handle necessary retransmissions, and to provide flow control so each device in a connection can manage the rate at which it is sent data.

TCP Standards

RFC 793 is the defining standard for TCP, but it doesn't include all the details of how modern TCP operates. Several other standards include additional information about how the protocol works, and describe enhancements to the basic TCP mechanisms that were developed over the years. Some of these are fairly “esoteric” and not widely known, but they are useful in gaining a more complete understanding of TCP. I have listed some of them in [Table 150](#)

Table 150: Supplementary TCP Standards (Page 1 of 2)

RFC Number	Name	Description
813	<u><i>Window and Acknowledgment Strategy in TCP</i></u>	Discusses the TCP sliding window acknowledgment system , describing certain problems that can occur with it and methods to correct them.
879	<u><i>The TCP Maximum Segment Size and Related Topics</i></u>	Discusses the important Maximum Segment Size (MSS) parameter that controls the size of TCP messages, and relates this parameter to IP datagram size.
896	<u><i>Congestion Control in IP/TCP Internetworks</i></u>	Talks about congestion problems and how TCP can be used to handle them. Note the interesting inversion of the normal protocol suite name: “IP/TCP”.
1122	<u><i>Requirements for Internet Hosts — Communication Layers</i></u>	Describes important details of how TCP should be implemented on hosts.
1146	<u><i>TCP Alternate Checksum Options</i></u>	Specifies a mechanism for having TCP devices use an alternative method of checksum generation.
1323	<u><i>TCP Extensions for High Performance</i></u>	Defines extensions to TCP for high-speed links, and new TCP options.
2018	<u><i>TCP Selective Acknowledgment Options</i></u>	An enhancement to basic TCP functionality that allows TCP devices to selectively specify specific segments for retransmission .

Table 150: Supplementary TCP Standards (Page 2 of 2)

RFC Number	Name	Description
2581	<i>TCP Congestion Control</i>	Describes four algorithms used for congestion control in TCP networks : slow start, congestion avoidance, fast retransmit and fast recovery.
2988	<i>Computing TCP's Retransmission Timer</i>	Discusses issues related to setting the TCP retransmission timer , which controls how long a device waits for acknowledgment of sent data before retransmitting it.

Of course, there are hundreds of higher-layer application protocols that use TCP, and whose defining standards therefore make at least glancing reference to it.

TCP is of course designed to use the Internet Protocol, since they were developed together and as we have seen, were even once part of the same specification. At the same time, they were split up for the specific reason of respect the principles of architectural layering. For this reason, TCP tries to make as few assumptions as possible regarding the underlying protocol over which it runs. It is not as strictly tied to the use of IP as one might imagine, and can even be adapted for use over other network-layer protocols. For our purposes, however, this should be considered mainly an "interesting aside". We will be assuming TCP works over IP in our discussions, since that is almost always how it is used.

TCP Functions: What TCP Does

We have now seen [where TCP comes from and the standards that describe it](#). As I said in the introduction to this section, TCP is a complicated protocol, so it will take some time to explain how it works. The most logical first "bite" in consuming this particular "elephant" is to look at exactly what TCP does. From there, we can describe its characteristics and then get into the details of its operation.

Functions Performed By TCP

Despite the complexity of TCP, its basic operation can be reasonably simplified by describing its primary functions. The following are what I believe to be the five main tasks that TCP performs:

- ☉ **Addressing/Multiplexing:** TCP is used by many different applications for their transport protocol. Therefore, like its simpler sibling UDP, an important job for TCP is *multiplexing* the data received from these different processes so they can be sent out using the underlying network-layer protocol. At the same time, these higher-layer application processes are identified using TCP ports. [The section on TCP/IP transport layer addressing](#) contains a great deal of detail on how this addressing works.
- ☉ **Connection Establishment, Management and Termination:** TCP provides a set of procedures that devices follow to [negotiate and establish a TCP connection](#) over which data can travel. Once opened, TCP includes logic for managing connections and handling problems that may result with them. When a device is done with a TCP connection, a special process is followed to terminate it.

-
- ☉ **Data Handling and Packaging:** TCP defines a mechanism by which applications are able to send data to it from higher layers. This data is then **packaged into messages** to be sent to the destination TCP software. The destination software unpackages the data and gives it to the application on the destination machine.
 - ☉ **Data Transfer:** Conceptually, the TCP implementation on a transmitting device is responsible for the transfer of packaged data to the TCP process on the other device. Following the principle of layering, this is done by having the TCP software on the sending machine pass the data packets to the underlying network-layer protocol, which again normally means IP.
 - ☉ **Providing Reliability and Transmission Quality Services:** TCP includes **a set of services and features** that allow an application to consider the sending of data using the protocol to be “reliable”. This means that normally, a TCP application doesn't have to worry about data being sent and never showing up, or arriving in the wrong order. It also means other common problems that might arise if IP were used directly are avoided.
 - ☉ **Providing Flow Control and Congestion Avoidance Features:** TCP allows the flow of data between two devices to be controlled and managed. It also includes features to deal with congestion that may be experienced during communication between devices.

Clearly, TCP is responsible for a fairly significant number of key functions. This list may not seem that impressive. The reason is that this is just a high-level look at the protocol, and these functions are summarized in the list above; when we look at them in detail we will see that each one actually involves a rather significant amount of work for TCP to do.

Functions Not Performed By TCP

TCP does so much that sometimes it is described as doing “everything” an application needs to use an internetwork. I may even have been guilty of this myself. However, the protocol **doesn't** do everything. It has limitations and certain areas that its designers specifically did not address. Among the notable functions TCP does not perform include:

- ☉ **Specifying Application Use:** TCP defines the transport protocol. It does not describe specifically how applications are to use TCP.
- ☉ **Providing Security:** TCP does not provide any mechanism for ensuring the authenticity or privacy of data it transmits. If these are needed they must be accomplished using some other means, such as **IPSec**, for example.
- ☉ **Maintaining Message Boundaries:** TCP sends data as a continuous stream, not as discrete messages. It is up to the application to specify where one message ends and the next begins.
- ☉ **Guaranteeing Communication:** Wait a minute... isn't the whole point of TCP supposed to be that it guarantees data will get to its destination? Well, yes and no. ☺ TCP will detect unacknowledged transmissions and re-send them if needed. However, in the event of some sort of problem that prevents reliable communication, all TCP can do is “keep trying”. It can't make any guarantees because there are too many things out of its control. Similarly, it can attempt to manage the flow of data, but cannot resolve every problem.

This last point might seem a bit pedantic, but is important to keep in mind, especially since the tendency is to think of TCP as somewhat “bulletproof”. The overall success of communication depends entirely on the underlying internetwork and the networks that constitute it. A chain is as strong as its weakest link, and if there is a problem at the lower layers, nothing TCP can do will guarantee successful data transfer.



Key Concept: TCP provides reliable communication only by detecting failed transmissions and re-sending them. It cannot guarantee any particular transmission, because it relies on IP, which is unreliable. All it can do is keep trying if an initial delivery attempt fails.

TCP Characteristics: How TCP Does What It Does

In [the preceding topic](#) we began our high-level look at TCP by examining the most important functions the protocol performs—as well as a few that it does not. In many ways, it is more interesting to look at **how** TCP does its job than the functions of the job itself. By examining the most important attributes of TCP and its operation, we can get a better handle on the way TCP works. We can also see the many ways that it contrasts to its simpler transport layer sibling, UDP.

TCP Characteristics

The following are the ways that I would best describe the Transmission Control Protocol and how it performs the functions described in the preceding topic:

- ☉ **Connection-Oriented:** TCP requires that devices first establish a connection with each other before they send data. The connection creates the equivalent of a circuit between the units, and is analogous to a telephone call. A process of negotiation occurs to establish the connection, ensuring that both devices agree on how data is to be exchanged.
- ☉ **Bidirectional:** Once a connection is established, TCP devices send data bidirectionally. Both devices on the connection can send and receive, regardless of which of them initiated the connection.
- ☉ **Multiply-Connected and Endpoint-Identified:** TCP connections are identified by the pair of sockets used by the two devices in the connection. This allows each device to have multiple connections opened, either to the same IP device or different IP devices, and to handle each connection independently without conflicts.
- ☉ **Reliable:** Communication using TCP is said to be *reliable* because TCP keeps track of data that has been sent and received to ensure it all gets to its destination. As we saw in the previous topic, TCP can't really “guarantee” that data will always be received. However, it **can** guarantee that all data sent will be checked for reception, and checked for data integrity, and then retransmitted when needed. So, while IP uses “best effort” transmissions, you could say TCP *tries harder*, as the old rent-a-car commercial goes.

-
- ☉ **Acknowledged:** A key to providing reliability is that all transmissions in TCP are acknowledged (at the TCP layer—TCP cannot guarantee that all such transmissions are received by the remote application). The recipient must tell the sender “yes, I got that” for each piece of data transferred. This is in stark contrast to typical messaging protocols where the sender never knows what happened to its transmission. As we will see, this is fundamental to the operation of TCP as a whole.
 - ☉ **Stream-Oriented:** Most lower-layer protocols are designed so that to use them, higher-layer protocols must send them data in blocks. IP is the best example of this; you send it a message to be formatted and it puts that message into a datagram. **UDP is the same.** In contrast, TCP allows applications to send it a continuous stream of data for transmission. Applications don't need to worry about making this into chunks for transmission; TCP does it.
 - ☉ **Data-Unstructured:** An important consequence of TCP's stream orientation is that there are no natural divisions between data elements in the application's data stream. When multiple messages are sent over TCP, applications must provide a way of differentiating one message (data element, record, etc.) from the next.
 - ☉ **Data-Flow-Managed:** TCP does more than just package data and send it as fast as possible. A TCP connection is *managed* to ensure that data flows evenly and smoothly, with means included to deal with problems that arise along the way.



Key Concept: To summarize TCP's key characteristics, we can say that it is connection-oriented, bidirectional, multiply-connected, reliable, acknowledged, stream-oriented and flow-managed.

The Robustness Principle

There's one more thing about TCP that is more an indication of the general maxim behind its creation than a particular characteristic of its operation. The TCP standard says that TCP follows the *robustness principle*, which is described thusly: “be conservative in what you do; be liberal in what you accept from others”. It means that every TCP implementation tries to avoid doing anything that would cause a problem for another device's TCP layer, while at the same time **also** trying to anticipate problems another TCP may cause and deal with them gracefully.

This principle represents a “belt and suspenders” approach that helps provide extra protection against unusual conditions in TCP operation. In fact, this general principle is applied to many other protocols in the TCP/IP suite, which is part of the reason why it has proven so capable over the years. It allows TCP and other protocols to often deal with even unanticipated problems that might show up in the difficult environment of a large inter-network such as the Internet.

Putting TCP's Performance In Perspective

Also, while we are on the subject of TCP's characteristics, I want to reinforce one other thing I said in [the overview of TCP and UDP](#): TCP has many attributes but one of them is ***not*** "slow". It is true that UDP is usually used by applications for performance reasons when they don't want to deal with the overhead TCP incorporates for connections and reliability. That, however, should not lead one to conclude that TCP is glacial, by any means. It is in fact quite efficient—were it not, it's unlikely it would have ever achieved such widespread use.



TCP Fundamentals and General Operation

Many people have a difficult time really understanding how the Transmission Control Protocol works. (After spending dozens of hours writing almost 100 pages on the protocol, I am quite sympathetic.) I think a main reason for the difficulty in absorbing TCP is that too many descriptions of the protocol quickly jump from a brief introduction straight into the mind-boggling details of TCP's operation. The problem is that TCP has a very particular **way** of doing certain things. Its operation is built around a few very important fundamentals that it is essential to understand before the details of TCP operation will make much sense.

In this section I describe some of the key operating fundamentals of TCP. I begin with a discussion of how TCP handles data, and introduce the concepts of streams, segments and sequences. I then describe the very important TCP *sliding window* system, used for acknowledgment, reliability and data flow control. I discuss how TCP uses ports, and how connections are identified. I also describe the most important applications that use TCP and what ports they use for server applications.

TCP Data Handling and Processing: Streams, Segments and Sequence Numbers

One of the “givens” in the operation of most of the protocols we find at upper layers in the OSI Reference Model is that they are oriented around the use of **messages**. These messages are analogous to a written letter in an envelope, containing a specific piece of information. They are passed from higher layers down to lower ones, where they are **encapsulated in the lower layer's headers** (like putting them in another envelope) and then passed down further until they are actually sent out at the physical layer.

A good example of this can be seen in looking at the **User Datagram Protocol**, TCP's transport layer peer. To use UDP, an application passes it a distinct block of data that is usually fairly short. The block is packaged into a UDP message, then sent to IP. IP packs the message into an IP datagram and eventually passes it to a layer two protocol such as Ethernet. There it is placed into a *frame* and sent to layer one for transmission.

Increasing the Flexibility of Application Data Handling: TCP's Stream Orientation

The use of discrete messaging is pretty simple, and it obviously works well enough since most protocols make use of it. However, it is inherently limiting, because it forces applications to create discrete blocks of data in order to communicate. There are many applications that need to send information continuously in a manner that doesn't lend itself well to creating “chunks” of data. Others need to send data in chunks that are so large that they could never be sent as a single message at the lower layers anyway.

To use a protocol like UDP, many applications would be forced to artificially divide their data into messages of a size that has no inherent meaning to them. This would immediately introduce new problems requiring more work for the application. It would have to keep track

of what data is in what message, and replace any that were lost. It would need to ensure that the messages could be reassembled in the correct order, since IP might deliver them out of order.

Of course, one *could* program applications to do this, but these functions are already ones that TCP is charged with taking care of, so it would make little sense. Instead, the designers of TCP took the very smart approach of generalizing TCP so it could accept application data of any size and structure, without requiring that it be in discrete pieces. More specifically, TCP is said to treat data coming from an application as a *stream*; thus, the description of TCP as *stream-oriented*. Each application sends the data it wishes to transmit as a steady stream of octets (bytes). It doesn't need to carve them into blocks, or worry about how lengthy streams will get across the internetwork. It just "pumps bytes" to TCP.

TCP Data Packaging: Segments

Of course, TCP must take these bytes and send them using a network-layer protocol, meaning the Internet Protocol. IP is a message-oriented protocol, not stream-oriented. Thus, we have simply "passed the buck" to TCP, which must take the stream from the application and divide it into discrete messages for IP. These messages are called TCP *segments*.



Note: As an aside, this is one of the most confusing data structure names in the world of networking. From a dictionary definition standpoint, referring to a piece of a stream as a *segment* is sensible, but most people working with networks don't think of a message as being a "segment". In the industry, the term also refers to a length of cable or a part of a local area network, among other things, so watch out for that.

TCP segments are treated by IP like all other discrete messages for transmission. They are placed into IP datagrams and transmitted to the destination device. The recipient unpackages the segments and passes them to TCP, which converts them back to a byte stream to send to the application. This process is illustrated in [Figure 202](#).

The TCP layer on a device accumulates data it receives from the application process stream. On regular intervals, it forms segments to be transmitted using IP. The size of the segment is controlled by two primary factors. The first issue is that there is an overall limit to the size of a segment, chosen to prevent unnecessary fragmentation at the IP layer. This is governed by a parameter called the [maximum segment size \(MSS\)](#), which is determined during connection establishment. The second is that TCP is designed so that once a connection is set up, each of the devices tells the other how much data it is ready to accept at any given time. If this is lower than the MSS value, a smaller segment must be sent. This is part of the [sliding window system described in the next topic](#).

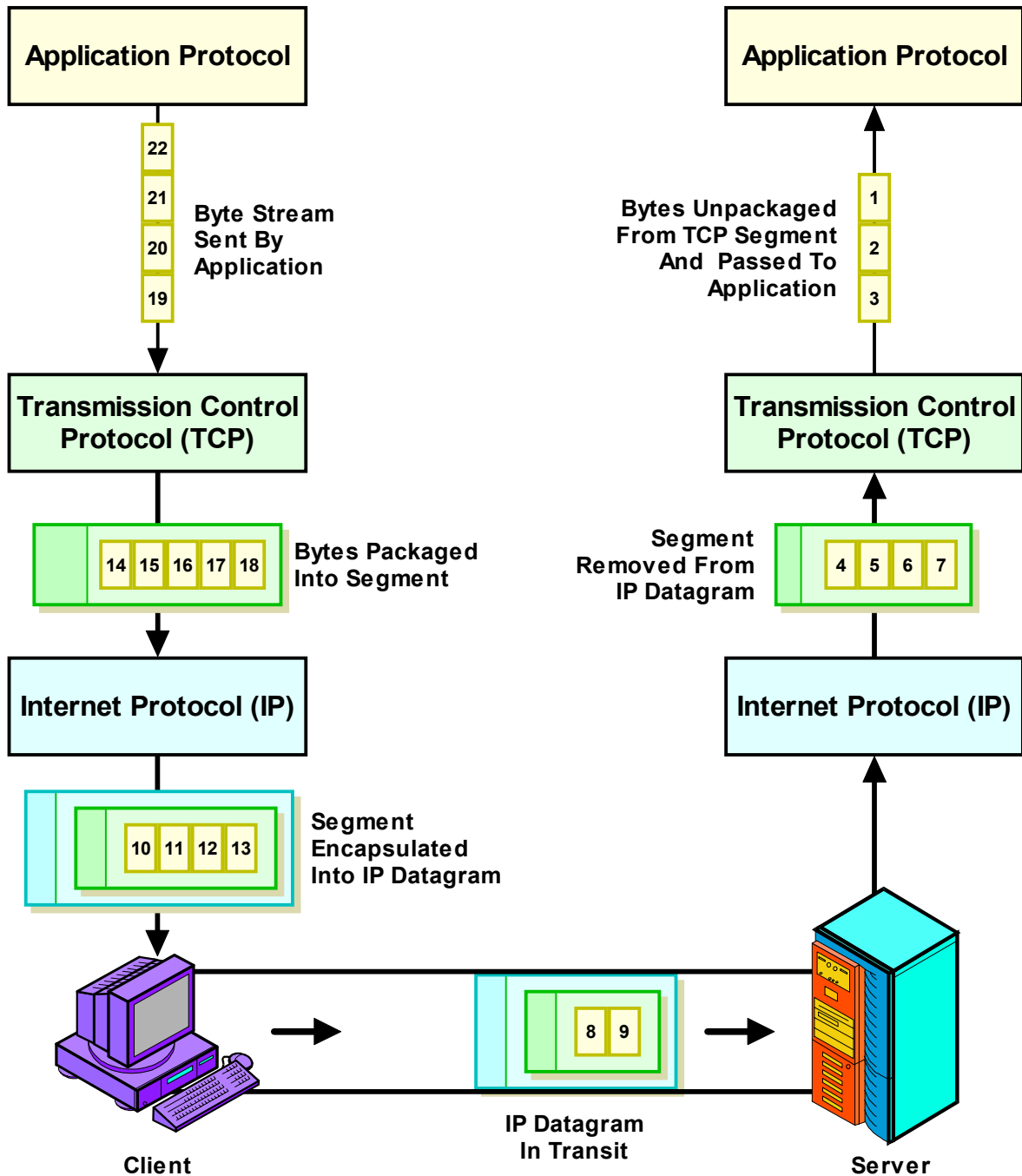

Figure 202: TCP Data Stream Processing and Segment Packaging

TCP is different from most protocols because it does not require applications that use it to send data to it in messages. Once a TCP connection is set up, an application protocol can send TCP a steady stream of bytes that does not need to conform to any particular structure. TCP packages these bytes into *segments* that are sized based on a number of different parameters. These segments are passed to IP, where they are encapsulated into IP datagrams and transmitted. The process is reversed by the receiving device: segments are removed from IP datagrams, then the bytes are taken from the segments and passed up to the appropriate recipient application protocol as a byte stream.



Key Concept: TCP is designed to have applications send data to it as a *stream* of bytes, rather than requiring fixed-size messages to be used. This provide maximum flexibility for a wide variety of uses, because applications don't need to worry about data packaging, and can send files or messages of any size. TCP takes care of packaging these bytes into messages called *segments*.

TCP Data Identification: Sequence Numbers

The fact that TCP treats data coming from an application as a stream of octets has a couple of very significant implications on the operation of the protocol. The first is related to *data identification*. Since TCP is reliable, it needs to keep track of all the data it receives from an application so it can make sure it is all received by the destination. Furthermore, it must make sure the data is received in the order it was sent, and must retransmit any lost data.

If data were conveyed to TCP in block-like messages, it would be fairly simple to keep track of the data by adding an identifier to each message. Since TCP is stream-oriented, however, that identification must be done for each byte of data! This may seem surprising, but it is actually what TCP does, through the use of *sequence numbers*. Each byte of data is assigned a sequence number which is used to keep track of it through the process of transmission, reception and acknowledgment (though in practice, blocks of many bytes are managed using the sequence numbers of bytes at the start and end of the block). These sequence numbers are used to ensure that data sent in segments is reassembled into the original stream of data transmitted by the sending application. They are required to implement the sliding window system that enables TCP to provide reliability and data flow control.



Key Concept: Since TCP works with individual bytes of data rather than discrete messages, it must use an identification scheme that works at the byte level to implement its data transmission and tracking system. This is accomplished by assigning each byte TCP processes a *sequence number*.

The Need For Application Data Delimiting

The other impact of TCP treating incoming data as a stream is that data received by an application using TCP is *unstructured*. For transmission, a stream of data goes into TCP on one device, and on reception, a stream of data goes back to the application on the receiving device. Even though the stream is broken into segments for transmission by TCP, these segments are TCP-level details that are hidden from the application. So, when a device wants to send multiple pieces of data, TCP provides no mechanism for indicating where the "dividing line" is between the pieces, since TCP doesn't examine the meaning of the data at all. The application must provide a means for doing this.

Consider for example an application that is sending database records. It needs to transmit record #579 from the *Employees* database table, followed by record #581 and record #611. It sends these records to TCP, which treats them all collectively as a stream of bytes. TCP will package these bytes into segments, but in a manner the application cannot predict. It is possible that each will end up in a different segment, but more likely they will all be in one segment, or part of each will end up in different segments, depending on their length. The records themselves must have some sort of explicit markers so the receiving device can tell where one record ends and the next starts.



Key Concept: Since applications send data to TCP as a stream of bytes and not prepackaged messages, each application must use its own scheme to determine where one application data element ends and the next begins.

TCP Sliding Window Acknowledgment System For Data Transport, Reliability and Flow Control

What differentiates the Transmission Control Protocol from simpler transport protocols like UDP is the **quality** of the manner in which it sends data between devices. Rather than just sticking data in a message and saying “off you go”, TCP carefully keeps track of the data it sends and what happens to it. This management of data is required to facilitate two key requirements of the protocol:

- ☉ **Reliability:** Ensuring that data that is sent actually arrives at its destination, and if not, detecting this and re-sending the data.
- ☉ **Data Flow Control:** Managing the rate at which data is sent so that it does not overwhelm the device that is receiving it.

To accomplish these tasks, the entire operation of the protocol is oriented around something called the *sliding window acknowledgment system*. It is no exaggeration to say that comprehending how sliding windows works is critical to understanding just about everything else in TCP. It is also, unfortunately, a bit hard to follow if you try to grasp it all at once, which means many people's eyes glaze over trying to make sense of it.

Since you can't really **get** TCP without understanding sliding windows, I wanted to make sure that I explained the mechanism thoroughly—and without assuming you already understand a great deal, as most references do. For this reason I am going to start with the concepts behind sliding windows and eventually explain how the technique works in general terms and why it is so powerful. Doing this properly required a considerable amount of explanation (which took a long time to get right, I might add!) so buckle your seat belt. ☺

The Problem With Unreliable Protocols: Lack of Feedback

A simple “send and forget” protocol like IP is unreliable and includes no flow control for one main reason: it is an *open loop* system where the transmitter receives no feedback from the recipient. (I'm ignoring error reports using ICMP and the like for the purpose of this

discussion.) A datagram is sent and it may or may not get there, but the transmitter will never have any way of knowing because no mechanism for feedback exists. This is shown conceptually in [Figure 203](#).

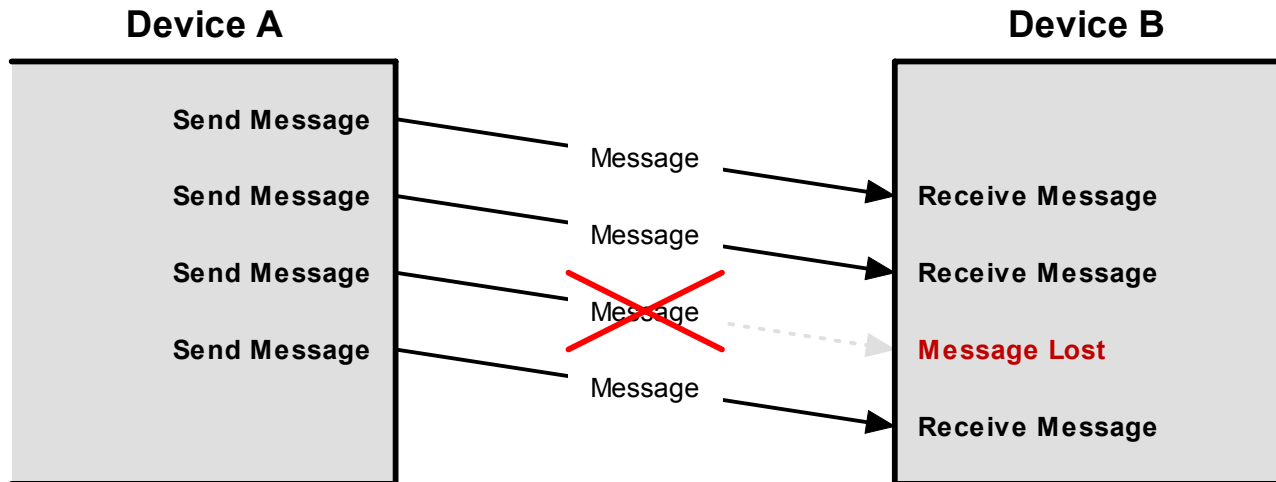

Figure 203: Operation Of An Unreliable Protocol

In a system such as that used by IP, if it gets there, great; otherwise, nobody will have a clue. ☹ Some external mechanism is needed to take care of the lost message, unless the protocol doesn't really care whether a few bits and pieces are missing from its message stream.

Providing Basic Reliability Using Positive Acknowledgment with Retransmission (PAR)

Basic reliability in a protocol running over an unreliable protocol like IP can be implemented by *closing the loop* so the recipient provides feedback to the sender. This is most easily done with a simple acknowledgment system. Device *A* sends a piece of data to Device *B*. Device *B*, receiving the data, sends back an *acknowledgment* saying, "Device *A*, I received your message". Device *A* then knows its transmission was successful.

Of course, since IP is unreliable, that message may in fact never get to where it is going. Device *A* will sit waiting for the acknowledgment and never receive it. Conversely, it is also possible that Device *B* gets the message from Device *A*, but the ***acknowledgment itself*** vanishes somehow. In either case, we don't want Device *A* to sit forever waiting for an acknowledgment that is never going to ever arrive.

To prevent this from happening, Device *A* starts a *timer* when it first sends the message to Device *B*, which allows sufficient time for the message to get to *B* and the acknowledgment to travel back, plus some reasonable time to allow for possible delays. If the timer expires before the acknowledgment is received, *A* assumes there was a problem and *retransmits* its original message. Since this method involves positive acknowledgments ("yes, I got your message") and a facility for retransmission when needed, it is commonly called (ta-da!) *positive acknowledgment with retransmission (PAR)*, as shown in [Figure 204](#).

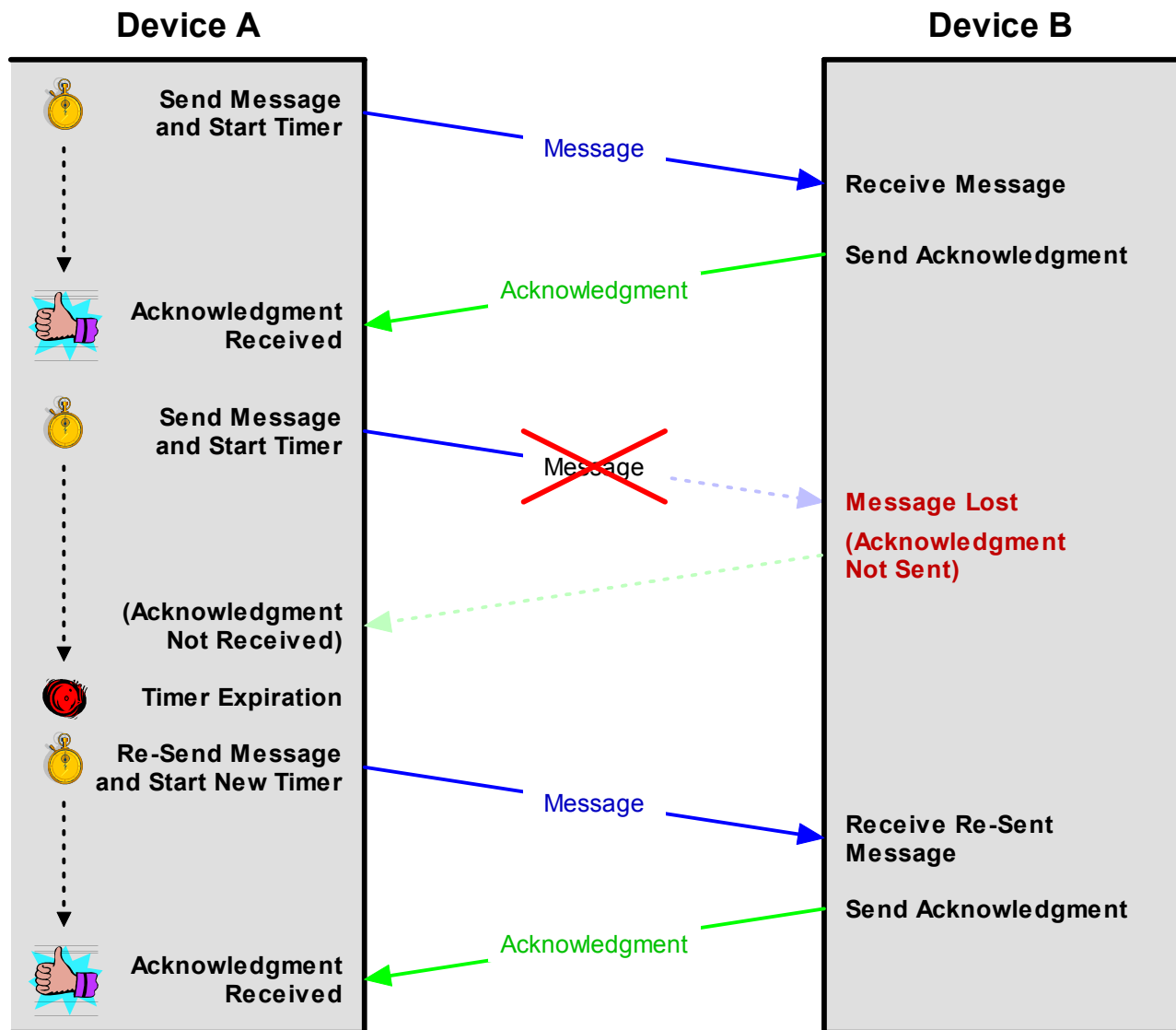

Figure 204: Basic Reliability: Positive Acknowledgment With Retransmission (PAR)

This diagram shows one of the most common simple techniques for ensuring reliability. Each time a message is sent by Device A, it starts a timer. Device B sends an acknowledgment back to A when it receives a message so A know it was successfully transmitted. If a message is lost, the timer goes off and A retransmits the data. Note that only one message can be outstanding at any time, making this system rather slow.



Key Concept: A basic technique for ensuring reliability in communications uses a rule that requires a device to send back an acknowledgment each time it successfully receives a transmission. If a transmission is not acknowledged after a period of time, it is retransmitted by its sender. This system is called *positive acknowledgment with retransmission (PAR)*. One drawback with this basic scheme is that the transmitter cannot send a second message until the first has been acknowledged.

Improving the Utility of PAR Through Message Identification and Send Limits

PAR is a technique that is used widely in networking and communications for protocols that exchange relatively small amounts of data, or exchange data infrequently. The basic method is functional, but it is not well-suited to a protocol like TCP for two reasons. The first is that it is **inefficient**. Device *A* sends a message and then waits for the acknowledgment. Device *A* cannot send another message to Device *B* until it hears that its original message was received, which is very wasteful and would make the protocol extremely slow.

The first improvement we can make to this system is to provide some means of identification to the messages sent and to the acknowledgments. For example, we could put a *message ID* field in the message header. The device sending the message would uniquely identify it, and the recipient would use this identifier in the acknowledgment. For example, Device *A* might send a piece of data in a message with the message ID #1. Device *B* would receive the message and then send its own message back to Device *A* saying “Device *A*, I received your message #1”. The advantage of this system is that Device *A* can send multiple messages at once. It must keep track of each one sent, and whether or not it was acknowledged. Each also requires a separate timer, but that's not a big problem.

Of course, we also need to consider this exchange from the standpoint of Device *B*. Before, it only had to deal with one message at a time from Device *A*. Now it may have several show up all at once. What if it is already busy with transmissions from another device (or ten)? We need some mechanism that lets Device *B* say “I am only willing to handle the following number of messages from you at a time”. We could do that by having the acknowledgment message contain a field, such as *send limit*, which specifies the maximum number of unacknowledged messages *A* was allowed to have in transit to *B* at one time.

Device *A* would use this *send limit* field to restrict the rate at which it sent messages to Device *B*. Device *B* could adjust this field depending on its current load and other factors to maximize performance in its discussions with Device *A*. This enhanced system would thus provide reliability, efficiency and basic data flow control, as illustrated in [Figure 205](#).



Key Concept: The basic PAR reliability scheme can be enhanced by identifying each message to be sent, so multiple messages can be in transit at once. The use of a *send limit* allows the mechanism to also provide flow control capabilities, by allowing each device to control the rate at which it is sent data.

TCP's Stream-Oriented Sliding Window Acknowledgment System

So, does TCP use this variation on PAR? Of course not! That would be too simple. Well, actually, the TCP sliding window system **is** very similar to this method, conceptually, which is why it is important for us to understand. However, it requires some adjustment. The main reason has to do with the way TCP handles data: the matter of *stream orientation* compared to *message orientation* [discussed in the previous topic](#). The technique we have

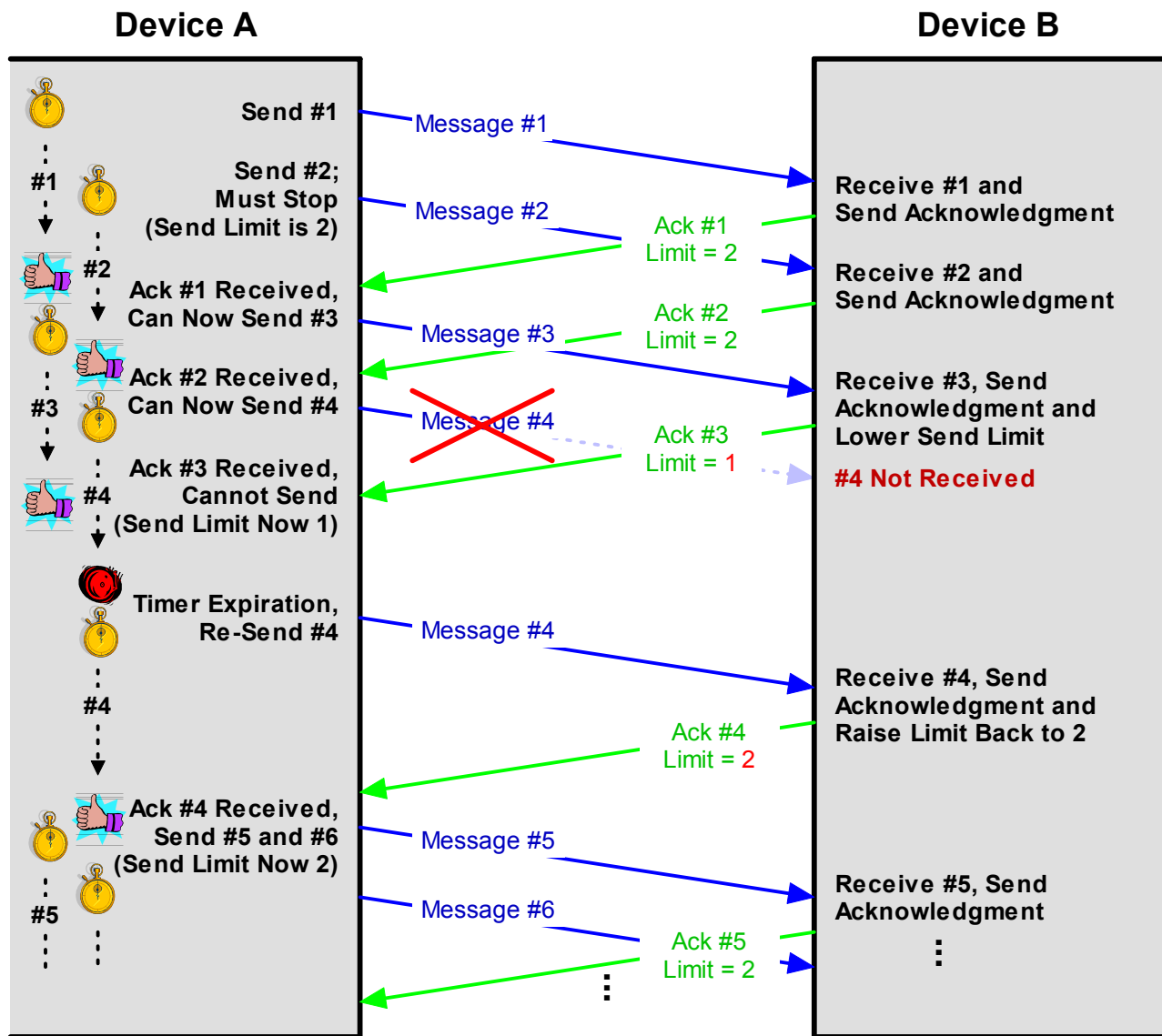

Figure 205: Enhanced Positive Acknowledgment With Retransmission (PAR)

This diagram shows two enhancements to the basic PAR scheme of Figure 204. First, each message now has an identification number; each can be acknowledged individually, so more than one can be in transit at a given time. Second, device B regularly communicates to A a *send limit* parameter, which restricts the number of messages A can have outstanding at once. B can adjust this parameter to control the flow of data from A.

outlined involves *explicit* acknowledgments and (if necessary) retransmissions for messages. Thus, it would work well for a protocol that exchanged reasonably large messages on a fairly infrequent basis.

TCP, on the other hand, deals with individual bytes of data as a stream. Transmitting each byte one at a time and acknowledging each one at a time would quite obviously be absurd. It would require too much work, and even with overlapped transmissions (not waiting for an acknowledgment before sending the next piece of data) the result would be horribly slow.

Of course, this is why TCP doesn't send bytes individually, it divides them into *segments*. All of the bytes in a segment are sent together and received together, and thus acknowledged together. TCP uses a variation on the method we described above, where the identification of data sent and acknowledged is done using [the sequence numbers we discussed in the previous topic](#). Instead of acknowledging using something like a *message ID* field, we acknowledge data using the sequence number of the last byte of data in the segment. Thus, we are dealing with a **range** of bytes in each case, the range representing the sequence numbers of all the bytes in the segment.

Conceptual Division of the TCP Transmission Stream Into Categories

Imagine a newly-established TCP connection between Device *A* and Device *B*. Device *A* has a long stream of bytes to be transmitted, but Device *B* can't accept them all at once. So it limits Device *A* to sending a particular number of bytes at once in segments, until the bytes in the segments already sent have been acknowledged. Then Device *A* is allowed to send more bytes. Each device keeps track of which bytes have been sent and which not, and which have been acknowledged.

At any point in time we can take a “snapshot” of the process. If we do, we can conceptually divide the bytes that the sending TCP has in its buffer into four categories, viewed as a timeline ([Figure 206](#)):

1. **Bytes Sent And Acknowledged:** The earliest bytes in the stream will have been sent and acknowledged. These are basically “accomplished” from the standpoint of the device sending data. For example, let's suppose that 31 bytes of data have already been sent and acknowledged. These would fall into Category #1.
2. **Bytes Sent But Not Yet Acknowledged:** These are the bytes that the device has sent but for which it has not yet received an acknowledgment. The sender cannot consider these “accomplished” until they are acknowledged. Let's say there are 14 bytes here, in Category #2.
3. **Bytes Not Yet Sent For Which Recipient Is Ready:** These are bytes that have not yet been sent, but which the recipient has room for based on its most recent communication to the sender of how many bytes it is willing to handle at once. The sender will try to send these immediately (subject to certain algorithmic restrictions we'll explore later). Suppose there are 6 bytes in Category #3.
4. **Bytes Not Yet Sent For Which Recipient Is Not Ready:** These are the bytes further “down the stream” which the sender is not yet allowed to send because the receiver is not ready. There are 44 bytes in Category #4.



Note: I am using very small numbers here to keep the example simple (and to make the diagrams a bit easier to construct!) TCP doesn't normally send tiny numbers of bytes around for efficiency reasons.

The receiving device uses a similar system to differentiate between data received and acknowledged, not yet received but ready to receive, and not yet received and not yet ready to receive. In fact, both devices maintain a separate set of variables to keep track of the

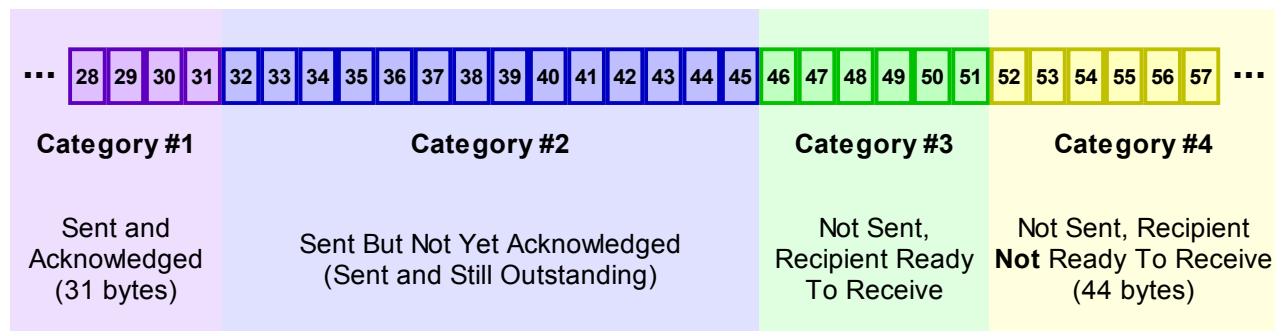

Figure 206: Conceptual Division of TCP Transmission Stream Into Categories

categories into which bytes fall in the stream they are sending as well as the one they are receiving. This is explored in [the topic describing the detailed sliding window data transfer procedure](#) (yes, there's even more on this subject!)



Key Concept: The TCP sliding window system is a variation on the enhanced PAR system, with changes made to support TCP's *stream orientation*. Each device keeps track of the status of the byte stream it needs to transmit by dividing them into four conceptual categories: bytes sent and acknowledged, bytes sent but not yet acknowledged, bytes not yet sent but that can be sent immediately, and bytes not yet sent that cannot be sent until the recipient signals that it is ready for them.

Sequence Number Assignment and Synchronization

The sender and receiver must agree on the sequence numbers to assign to the bytes in the stream. This is called *synchronization* and [is done when the TCP connection is established](#). For simplicity, let's assume the first byte was sent with sequence number 1 (this is not normally the case). Thus, in our example the byte ranges for the four categories are:

1. **Bytes Sent And Acknowledged:** Bytes 1 to 31.
2. **Bytes Sent But Not Yet Acknowledged:** Bytes 32 to 45.
3. **Bytes Not Yet Sent For Which Recipient Is Ready:** Bytes 46 to 51.
4. **Bytes Not Yet Sent For Which Recipient Is Not Ready:** Bytes 52 to 95.

The Send Window and Usable Window

The key to the operation of the entire process is the number of bytes that the recipient is allowing the transmitter to have unacknowledged at one time. This is called the *send window*, or often, just the *window*. The window is what determines how many bytes the sender is allowed to transmit, and is equal to the sum of the number of bytes in Category #2 and Category #3. Thus, the dividing line between the last two categories (bytes not sent

that recipient is ready for and ones it is *not* ready for) is determined by adding the window to the byte number of the first unacknowledged byte in the stream. In our example above, the first unacknowledged byte is #32. The total window size is 20.

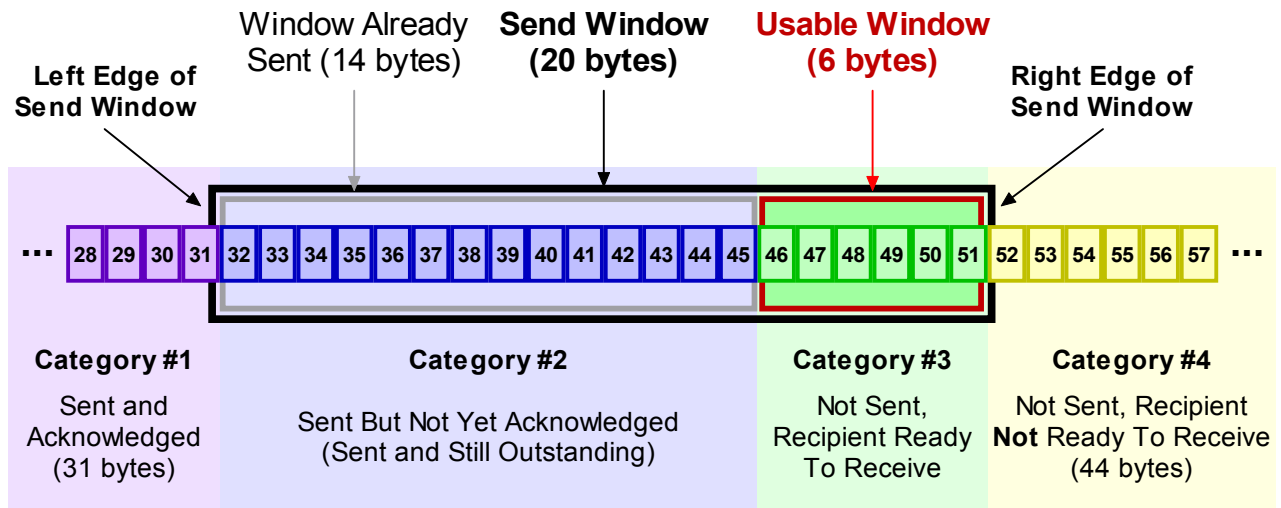

Figure 207: TCP Transmission Stream Categories and Send Window Terminology

This diagram shows the same categories as [Figure 206](#), with the *send window* indicated as well. The black box is the overall send window (categories #2 and #3 combined); the gray represents the bytes already sent (category #2) and the red box is the *usable window* (category #3).

The term *usable window* is defined as the amount of data the transmitter is still allowed to send given the amount of data that is outstanding. It is thus exactly equal to the size of Category #3. You may also commonly hear mention of the *edges* of the window. The *left edge* marks the first byte in the window (byte 32 above). The *right edge* marks the last byte in the window (byte 51). Please see [Figure 207](#) for a graphical view of these concepts.



Key Concept: The *send window* is the key to the entire TCP sliding window system: it represents the maximum number of unacknowledged bytes a device is allowed to have outstanding at once. The *usable window* is the amount of the send window that the sender is still allowed to send at any point in time; it is equal to the size of the send window less the number of unacknowledged bytes already transmitted.

Changes to TCP Categories and Window Sizes After Sending Bytes In the Usable Window

Now, let's suppose that in our example above, there is nothing stopping the sender from immediately transmitting the 6 bytes in the Category #3 (the usable window). When it does so, the 6 bytes will shift from Category #3 to Category #2. The byte ranges will now be as follows ([Figure 208](#)):

1. **Bytes Sent And Acknowledged:** Bytes 1 to 31.
2. **Bytes Sent But Not Yet Acknowledged:** Bytes 32 to 51.

3. **Bytes Not Yet Sent For Which Recipient Is Ready:** None.
4. **Bytes Not Yet Sent For Which Recipient Is Not Ready:** Bytes 52 to 95.

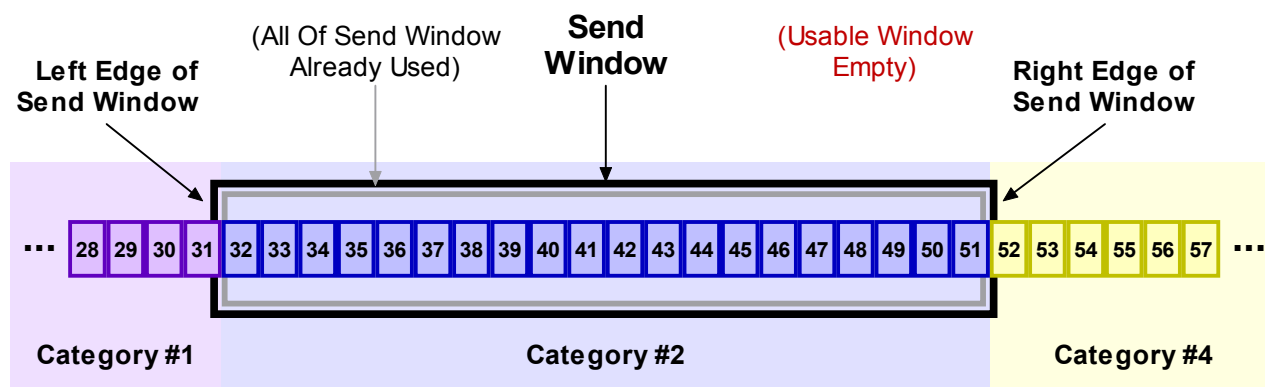

Figure 208: TCP Stream Categories and Window After Sending Usable Window Bytes

This diagram shows the result of the device sending all the bytes it is allowed to transmit in its usable window. It is the same as [Figure 207](#), except that all the bytes in category #3 have moved to category #2. The usable window is now zero, and will remain so until an acknowledgment is received for bytes in category #2.

Processing Acknowledgments and Sliding the Send Window

Some time later, the destination device sends back a message to the sender providing an acknowledgment. It will not specifically list out the bytes that have been acknowledged, because as we said before, doing this would be inefficient. Instead, it will acknowledge a **range** of bytes that represents the longest contiguous sequence of bytes received since the ones it had previously acknowledged.

For example, let's suppose that the bytes already sent but not yet acknowledged at the start of the example (32 to 45) were transmitted in four different segments. These segments carried bytes 32 to 34, 35 to 36, 37 to 41 and 42 to 45 respectively. The first, second and fourth segments arrived, but the third did not. The receiver will send back an acknowledgment **only** for bytes 32 to 36 (32-34 and 35-36). It will hold bytes 42 to 45 but not acknowledge them, because this would imply receipt of bytes 37 to 41, which have not shown up yet. This is necessary because TCP is a *cumulative acknowledgment* system, which can only use a single number to acknowledge data, the number of the last contiguous byte in the stream successfully received. Let's also say the destination keeps the window size the same, at 20 bytes.



Note: An optional feature called *selective acknowledgments* does allow non-contiguous blocks of data to be acknowledged. This is explained in [a separate topic in a later section](#); we'll ignore this complication for now.

When the sending device receives this acknowledgment, it will be able to transfer some of the bytes from Category #2 to Category #1, since they have now been acknowledged. When it does so, something interesting will happen. Since five bytes have been acknowledged, and the window size didn't change, the sender is allowed to send five more bytes. In effect, the window shifts, or **slides**, over to the right in the timeline. At the same time five bytes move from Category #2 to Category #1, five bytes move from Category #4 to Category #3, creating a new usable window for subsequent transmission. So, after receipt of the acknowledgment, the groups will look like this (Figure 209):

1. **Bytes Sent And Acknowledged:** Bytes 1 to 36.
2. **Bytes Sent But Not Yet Acknowledged:** Bytes 37 to 51.
3. **Bytes Not Yet Sent For Which Recipient Is Ready:** Bytes 52 to 56.
4. **Bytes Not Yet Sent For Which Recipient Is Not Ready:** Bytes 57 to 95.

This process will occur each time an acknowledgment is received, causing the window to slide across the entire stream to be transmitted. And thus, ladies and gentlemen, we have the TCP *sliding window* acknowledgment system. It is a very powerful technique, which allows TCP to easily acknowledge an arbitrary number of bytes using a single acknowledgment number, thus providing reliability to the byte-oriented protocol without spending time on an excessive number of acknowledgments. For simplicity, the example above leaves the window size constant, but in reality it can be adjusted to allow a recipient to control the rate at which data is sent, enabling [flow control and congestion handling](#).

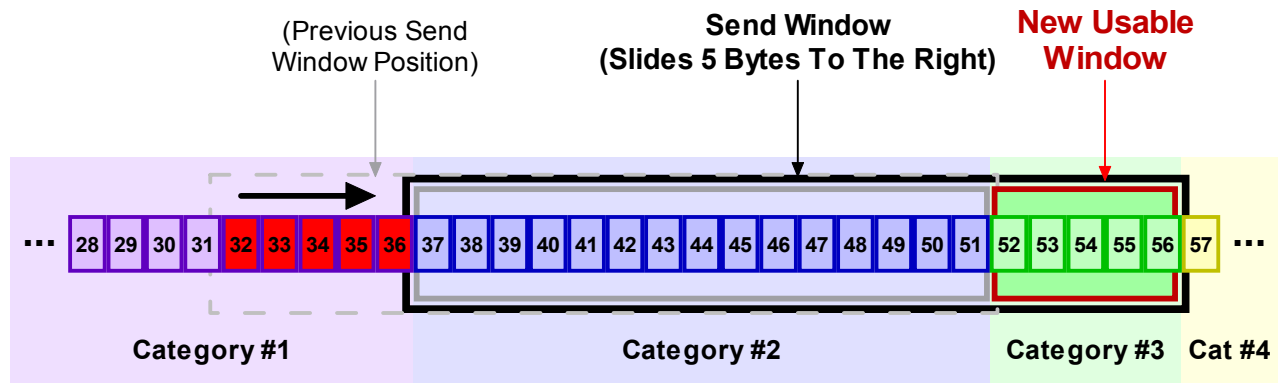

Figure 209: Sliding The TCP Send Window

After receiving acknowledgment for bytes 32 to 36, they move from category #2 to #1. The send window of Figure 208 slides right by five bytes; shifting five bytes from category #4 to #3, opening a new usable window.



Key Concept: When a device gets an acknowledgment for a range of bytes, it knows they have been successfully received by their destination. It moves them from the “sent but unacknowledged” to the “sent and acknowledged” category. This causes the send window to *slide* to the right, allowing the device to send more data.

Dealing With Missing Acknowledgments

But wait... what about bytes 42 through 45 in our example? Well, until segment #3 (containing bytes 37 to 41) shows up, the receiving device will not send an acknowledgment for those bytes, nor any others that show up after it. The sender will be able to send the new bytes added to Category #3: bytes 52 to 56. It will then stop, with the window “stuck” on bytes 37 to 41.

Of course, like any PAR system, TCP includes a system for timing transmissions and retransmitting. Eventually, the TCP device will re-send the lost segment, and hopefully this time it will arrive again. Unfortunately, one drawback of TCP is that since it does *not* separately acknowledge segments, this may mean retransmitting other segments that actually were received by the recipient (such as the segment with bytes 42 to 45). This starts to get very complex, [as discussed in the topic on TCP retransmissions](#).



Key Concept: TCP acknowledgments are *cumulative*, and tell a transmitter that all the bytes up to the sequence number indicated in the acknowledgment were received successfully. Thus, if bytes are received out of order, they cannot be acknowledged until all the preceding bytes are received. TCP includes a method for timing transmissions and retransmitting lost segments if necessary.

More Information on TCP Sliding Windows

I should explicitly point out that despite the length of this topic, the preceding is just a **summary** description of the overall operation of sliding windows, and one that does not include all of the modifications used in modern TCP! As you can see, the sliding window mechanism is at the heart of the operation of TCP as a whole.

In [the section that describes segments and discusses data transfer](#) we will see in more detail how TCP transmitters decide how and when to create segments for transmission. [The section describing TCP's reliability and data flow control features](#) will provide much more information on how sliding windows enable a device to manage the flow of data to it on a TCP connection. It also discusses [special problems that can arise if windows size is not carefully managed](#), and how [problems such as congestion are avoided](#) in TCP implementations through key changes to the basic sliding window mechanism described in this topic.

TCP Ports, Connections and Connection Identification

The two TCP/IP transport layer protocols, TCP and UDP, play the same architectural role in the protocol suite, but do it in *very* different ways. In fact, one of the few functions that the two have in common is providing a method of transport-layer addressing and multiplexing. Through the use of *ports*, both protocols allow the data from many different application processes to be aggregated and sent through the IP layer, and then returned up the stack to the proper application process on the destination device. This is all explained in detail in [the section describing ports and sockets](#).

Despite this commonality, TCP and UDP diverge somewhat even in how they deal with processes. UDP is a connectionless protocol, which of course means devices do not set up a formal connection before sending data. UDP doesn't have to use sliding windows, or keep track of how long it has been since a transmission was sent and so forth. When the UDP layer on a device receives data it just sends it to the process indicated by the destination port, and that's that. It can seamlessly handle any number of processes sending it messages because they are all handled identically.

Connection-Handling Responsibilities

Since TCP is connection-oriented, it has many more responsibilities. Each TCP software layer needs to be able to support connections to several other TCPs simultaneously. The operation of each connection is separate from of each other connection, and the TCP software must manage each independently. It must be sure not only that data is routed to the right process, but that data transmitted on each connection is managed without any overlap or confusion.

Connection Identification

The first consequence of this is that each connection must be uniquely identified. This is done by using the pair of socket identifiers corresponding to the two *endpoints* of the connection, where a socket is simply the combination of the IP address and the port number of each process. This means a socket pair contains four pieces of information: source address, source port, destination address. Thus, TCP connections are sometimes said to be described by this addressing *quadruple*.

I introduced this in [the general topic on TCP/IP sockets](#), where I gave the example of an HTTP request sent from a client at 177.41.72.6 to a Web site at 41.199.222.3. The server for that Web site will use well-known port number 80, so its socket is 41.199.222.3:80. If the client has been assigned ephemeral port number 3,022 for the Web browser, the client socket is 177.41.72.6:3022. The overall connection between these devices can be described using this socket pair:

(41.199.222.3:80, 177.41.72.6:3022)

Multiple Connection Management

This identification of connections using both client and server sockets is what provides the flexibility in allowing multiple connections between devices that we take for granted on the Internet. For example, busy application server processes (such as Web servers) must be able to handle connections from more than one client, or the World Wide Web would be pretty much unusable. Since the connection is identified using the client's socket as well as the server's, this is no problem. At the same time that the Web server maintains the connection mentioned just above, it can easily have another connection to say, port 2,199 at IP address 219.31.0.44. This is represented by the connection identifier:

(41.199.222.3:80, 219.31.0.44:2199).

In fact, we can have multiple connections from the same client to the same server. Each client process will be assigned a different ephemeral port number, so even if they all try to access the same server process (such as the Web server process at 41.199.222.3:80), they will all have a different client socket and represent unique connections. This is what lets you make several simultaneous requests to the same Web site from your computer.

Again, TCP keeps track of each of these connections independently, so each connection is unaware of the others. TCP can handle hundreds or even thousands of simultaneous connections. The only limit is the capacity of the computer running TCP, and the bandwidth of the physical connections to it—the more connections running at once, the more each one has to *share* limited resources.



Key Concept: Each device can handle simultaneous TCP connections to many different processes on one or more devices. Each connection is identified by the socket numbers of the devices in the connection, called the connection's *endpoints*. Each endpoint consists of the device's IP address and port number, so each connection is identified by the *quadruple* of client IP address and port number, and server IP address and port number.

TCP Common Applications and Server Port Assignments

We saw in [the overview of TCP](#) that the protocol originally included the functions of both modern TCP and the Internet Protocol. TCP was split into TCP and IP to allow applications that didn't need TCP's complexity to bypass it, using the much simpler [UDP](#) instead as a transport layer protocol instead. This was an important step in the development of the TCP/IP protocol suite, since there are several important protocols for which UDP is ideally suited, and even some where TCP is more of a nuisance than a benefit.

Most commonly, however, UDP is only used in special cases. The UDP applications topic describes the two types of protocols that may be better suited to UDP than TCP: ones where speed is more important than reliability, and ones that send only short messages infrequently. The majority of TCP/IP applications do not fall into these categories. Thus, even though the layering of TCP and IP means most protocols aren't **required** to use TCP, most of them do anyway. The majority of the protocols that use it employ all or at least most of the features it provides. The establishment of a persistent connection is necessary for many interactive protocols, such as [Telnet](#), as well as for ones that send commands and status replies, like [HTTP](#). Reliability and flow control are essential for protocols that send large files, like [FTP](#) or [the e-mail protocols](#).

Table 151 shows some of the more significant application protocols that run on TCP. I have shown for each the well-known or registered port number reserved for that protocol's server process (clients use [ephemeral ports](#), not the port numbers in the table). I have also shown the special "keyword" shortcut for each port assignment, and provided brief comments on why the protocol is well-matched to TCP.

Table 151: Common TCP Applications and Server Port Assignments (Page 1 of 2)

Port #	Keyword	Protocol	Comments
20 and 21	ftp-data / ftp	File Transfer Protocol (FTP, data and control)	Used to send large files, so ideally suited for TCP.
23	telnet	Telnet Protocol	Interactive session-based protocol. Requires the connection-based nature of TCP.
25	smtp	Simple Mail Transfer Protocol (SMTP)	Uses an exchange of commands, and sends possibly large files between devices.
53	domain	Domain Name Server (DNS)	An example of a protocol that uses both UDP and TCP. For simple requests and replies, DNS uses UDP. For larger messages, especially zone transfers, TCP is used.
70	gopher	Gopher Protocol	A messaging protocol that has been largely replaced by the WWW.
80	http	Hypertext Transfer Protocol (HTTP / World Wide Web)	The classic example of a TCP-based messaging protocol.
110	pop3	Post Office Protocol (POP version 3)	E-mail message retrieval protocols; use TCP to exchange commands and data.
119	nntp	Network News Transfer Protocol (NNTP)	Used for transferring NetNews (USEnet) messages, which can be lengthy.
139	netbios-ssn	NetBIOS Session Service	A session protocol, clearly better suited to TCP than UDP.
143	imap	Internet Message Access Protocol (IMAP)	Another e-mail message retrieval protocol.
179	bgp	Border Gateway Protocol (BGP)	While interior routing protocols like RIP and OSPF use either UDP or IP directly, BGP runs over TCP. This allows BGP to assume reliable communication even as it sends data over potentially long distances.
194	irc	Internet Relay Chat (IRC)	IRC is like Telnet in that it is an interactive protocol that is strongly based on the notion of a persistent connection between a client and server.

Table 151: Common TCP Applications and Server Port Assignments (Page 2 of 2)

Port #	Keyword	Protocol	Comments
2049	nfs	Network File System (NFS)	NFS was original implemented using UDP for performance reasons. Given that it is responsible for large transfers of files and UDP is unreliable, this was probably not the best idea, and TCP versions were created. The latest version of NFS uses TCP exclusively.
6000 - 6063	TCP	x11	Used for the X Window graphical system. Multiple ports are dedicated to allow many sessions.

A couple of the protocols in the table above use both TCP and UDP, to get the “best of both worlds”. Short, simple messages can be sent with UDP, while larger files are moved with TCP. Many of the protocols that use both TCP and UDP are actually [utility/diagnostic protocols](#) (such as Echo, Discard and the Time Protocol). These are a special case, because they were designed to use both UDP and TCP specifically to allow their use for diagnostics on both protocols.

I haven't included an exhaustive list of TCP applications above; see [the topic on common TCP/IP applications and port numbers](#), which also contains a pointer to the full (massive) list of TCP well-known and registered server ports.



TCP Basic Operation: Connection Establishment, Management and Termination

While I have described the Transmission Control Protocol as *connection-oriented*, this term isn't "just any old characteristic" of TCP. The overall operation of the entire protocol can be described in terms of how TCP software prepares, negotiates, establishes, manages and terminates connections. TCP implementations certainly do more than handle connections, but the other major tasks they perform, such as data handling and providing reliability and flow control, can only occur over a stable connection. This makes connections the logical place to begin in exploring the details of how TCP does its thing.

In this section I describe TCP connections from start to finish. I begin with an overview of TCP's operation by providing a summary of the *finite state machine* that formally defines the stages of a connection. State machines can be a bit mind-boggling when you read about them in standards, but a simplified version provides an excellent high-level view of the "life" of a connection, so it is a good place to start.

From there, I move on to provide details about TCP's handling of connections. I described how connections are prepared and transmission control blocks (TCBs) set up, and the difference between a passive and an active socket open. I explain the three-way handshake used to create a connection, and the method by which parameters are exchanged and sequence numbers synchronized. I talk about how an established connection is managed, including the method by which TCP handles problem conditions and resets the connection when necessary. Finally, I describe how a connection can be terminated when it is no longer needed.



Background Information: The detailed topics in this section assume your familiarity with [the concepts in the previous fundamentals section](#), especially the notion of [sequence numbers](#).

TCP Operational Overview and the TCP Finite State Machine (FSM)

It is essential that all devices that implement any networking protocol do so in a consistent manner. Otherwise, one device might behave in a manner the other wouldn't expect. Naturally, this is why there are standards that describe the operation of each protocol. The problem with a protocol like TCP is that it performs so many tasks that it is difficult to specify the exact operation of all aspects of the protocol succinctly.

Using A Finite State Machine to Explain Complex Protocols

One way that computer scientists explain how a complex protocol works is through a theoretical tool called a *finite state machine (FSM)*. An FSM attempts to describe a protocol or algorithm by considering it like a virtual "machine" that progresses through a series of stages of operation in response to various happenings. You need to understand four essential concepts to comprehend the workings of a finite state machine:

-
- ☉ **State:** The particular “circumstance” or “status” that describes the protocol software on a machine at a given time.
 - ☉ **Transition:** The act of moving from one state to another.
 - ☉ **Event:** Something that causes a transition to occur between states.
 - ☉ **Action:** Something a device does in response to an event before it transitions to another state.

A FSM describes the protocol by explaining all the different states the protocol can be in, the events that can occur in each state, what actions are taken in response to the events and what transitions happen as a result. The protocol usually starts in a particular *beginning state* when it is first run. It then follows a sequence of steps to get it into a regular operating state, and moves to other states in response to particular types of input or other circumstances. The state machine is called *finite* because there are only a limited number of states.



Key Concept: A tool used by many computer scientists to describe the operation of a protocol or algorithm is the *finite state machine*. It describes the different actions taken by a piece of software over time by defining a finite number of operating *states*, *events* that can cause *transitions* between states, and *actions* taken in response to events.

The Simplified TCP Finite State Machine

In the case of TCP, the finite state machine can be considered to describe the “life stages” of a connection. Each connection between one TCP device and another begins in a null state where there is no connection, and then proceeds through a series of states until a connection is established. It remains in that state until something occurs to cause the connection to be closed again, at which point it proceeds through another sequence of transitional states and returns to the closed state.

The full description of the states, events and transitions in a TCP connection is lengthy and complicated—not surprising, since that would cover much of the entire TCP standard. For our purposes, that level of detail would be a good cure for insomnia but not much else. However, a **simplified** look at the TCP FSM will help give us a nice overall feel for how TCP establishes connections and then functions when a connection has been created.

[Table 152](#) briefly describes each of the TCP states in a TCP connection, and also describes the main events that occur in each state, and what actions and transitions occur as a result. For brevity, three abbreviations are used for three types of message that control transitions between states, which correspond to the [TCP header flags](#) that are set to indicate a message is serving that function. These are:

- ☉ **SYN:** A *synchronize* message, used to initiate and establish a connection. It is so named since one of its functions is to synchronize sequence numbers between devices.

- ☉ **FIN:** A *finish* message, which is a TCP segment with the *FIN* bit set, indicating that a device wants to terminate the connection.
- ☉ **ACK:** An *acknowledgment*, indicating receipt of a message such as a *SYN* or a *FIN*.

Again, I have not shown every possible transition, just the ones normally followed in the life of a connection. Error conditions also cause transitions but including these would move us well beyond a “simplified” state machine. The FSM is also illustrated in [Figure 210](#), which you may find easier for seeing how state transitions occur.

Table 152: TCP Finite State Machine (FSM) States, Events and Transitions
(Page 1 of 2)

State	State Description	Event and Transition
CLOSED	This is the default state that each connection starts in before the process of establishing it begins. The state is called “fictional” in the standard. The reason is that this state represents the situation where there is no connection between devices—it either hasn't been created yet, or has just been destroyed. If that makes sense. ☺	Passive Open: A server begins the process of connection setup by doing a passive open on a TCP port. At the same time, it sets up the data structure (transmission control block or TCB) needed to manage the connection. It then transitions to the <i>LISTEN</i> state.
		Active Open, Send SYN: A client begins connection setup by sending a <i>SYN</i> message, and also sets up a TCB for this connection. It then transitions to the <i>SYN-SENT</i> state.
LISTEN	A device (normally a server) is waiting to receive a <i>synchronize (SYN)</i> message from a client. It has not yet sent its own <i>SYN</i> message.	Receive Client SYN, Send SYN+ACK: The server device receives a <i>SYN</i> from a client. It sends back a message that contains its own <i>SYN</i> and also acknowledges the one it received. The server moves to the <i>SYN-RECEIVED</i> state.
SYN-SENT	The device (normally a client) has sent a <i>synchronize (SYN)</i> message and is waiting for a matching <i>SYN</i> from the other device (usually a server).	Receive SYN, Send ACK: If the device that has sent its <i>SYN</i> message receives a <i>SYN</i> from the other device but not an <i>ACK</i> for its own <i>SYN</i> , it acknowledges the <i>SYN</i> it receives and then transitions to <i>SYN-RECEIVED</i> to wait for the acknowledgment to its <i>SYN</i> .
		Receive SYN+ACK, Send ACK: If the device that sent the <i>SYN</i> receives both an acknowledgment to its <i>SYN</i> and also a <i>SYN</i> from the other device, it acknowledges the <i>SYN</i> received and then moves straight to the <i>ESTABLISHED</i> state.
SYN-RECEIVED	The device has both received a <i>SYN</i> (connection request) from its partner and sent its own <i>SYN</i> . It is now waiting for an <i>ACK</i> to its <i>SYN</i> to finish connection setup.	Receive ACK: When the device receives the <i>ACK</i> to the <i>SYN</i> it sent, it transitions to the <i>ESTABLISHED</i> state.

Table 152: TCP Finite State Machine (FSM) States, Events and Transitions
(Page 2 of 2)

State	State Description	Event and Transition
ESTABLISHED	The “steady state” of an open TCP connection. Data can be exchanged freely once both devices in the connection enter this state. This will continue until the connection is closed for one reason or another.	Close, Send FIN: A device can close the connection by sending a message with the <i>FIN</i> (<i>finish</i>) bit sent and transition to the <i>FIN-WAIT-1</i> state.
		Receive FIN: A device may receive a <i>FIN</i> message from its connection partner asking that the connection be closed. It will acknowledge this message and transition to the <i>CLOSE-WAIT</i> state.
CLOSE-WAIT	The device has received a close request (<i>FIN</i>) from the other device. It must now wait for the application on the local device to acknowledge this request and generate a matching request.	Close, Send FIN: The application using TCP, having been informed the other process wants to shut down, sends a close request to the TCP layer on the machine upon which it is running. TCP then sends a <i>FIN</i> to the remote device that already asked to terminate the connection. This device now transitions to <i>LAST-ACK</i> .
LAST-ACK	A device that has already received a close request and acknowledged it, has sent its own <i>FIN</i> and is waiting for an <i>ACK</i> to this request.	Receive ACK for FIN: The device receives an acknowledgment for its close request. We have now sent our <i>FIN</i> and had it acknowledged, and received the other device's <i>FIN</i> and acknowledged it, so we go straight to the <i>CLOSED</i> state.
FIN-WAIT-1	A device in this state is waiting for an <i>ACK</i> for a <i>FIN</i> it has sent, or is waiting for a connection termination request from the other device.	Receive ACK for FIN: The device receives an acknowledgment for its close request. It transitions to the <i>FIN-WAIT-2</i> state.
		Receive FIN, Send ACK: The device does not receive an <i>ACK</i> for its own <i>FIN</i> , but receives a <i>FIN</i> from the other device. It acknowledges it, and moves to the <i>CLOSING</i> state.
FIN-WAIT-2	A device in this state has received an <i>ACK</i> for its request to terminate the connection and is now waiting for a matching <i>FIN</i> from the other device.	Receive FIN, Send ACK: The device receives a <i>FIN</i> from the other device. It acknowledges it and moves to the <i>TIME-WAIT</i> state.
CLOSING	The device has received a <i>FIN</i> from the other device and sent an <i>ACK</i> for it, but not yet received an <i>ACK</i> for its own <i>FIN</i> message.	Receive ACK for FIN: The device receives an acknowledgment for its close request. It transitions to the <i>TIME-WAIT</i> state.
TIME-WAIT	The device has now received a <i>FIN</i> from the other device and acknowledged it, and sent its own <i>FIN</i> and received an <i>ACK</i> for it. We are done, except for waiting to ensure the <i>ACK</i> is received and prevent potential overlap with new connections. (See the topic describing connection termination for more details on this state.)	Timer Expiration: After a designated wait period, device transitions to the <i>CLOSED</i> state.

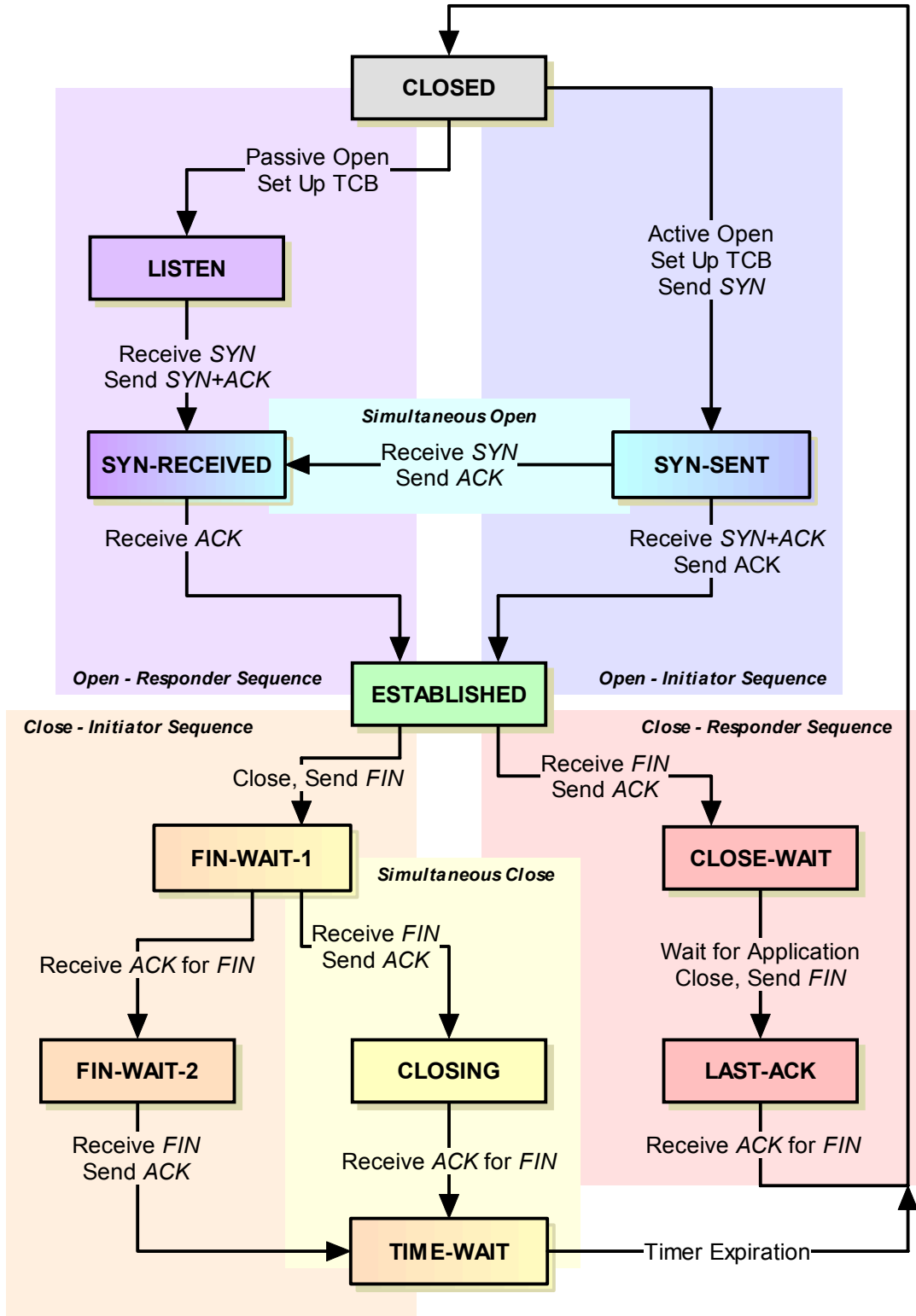

Figure 210: The TCP Finite State Machine (FSM)

This diagram illustrates the simplified TCP FSM. The color codings are not an official part of the definition of the FSM; I have added them to show more clearly the sequences taken by the two devices to open and close a link. For both establishment and termination there is a regular sequence, where the initiating and responding devices go through different states, and a *simultaneous* sequence where each uses the same sequence.

Tap tap... still awake? Okay, I guess even with serious simplification, that FSM isn't all that simple. It may seem a bit intimidating at first, but if you take a few minutes with it, you can get a good handle on how TCP works. The FSM will be of great use in making sense of the connection establishment and termination processes later in this section—and conversely, reading those sections will help you make sense of the FSM. So if your eyes have glazed over completely, just carry on and try coming back to this topic later.

Finite State Machine Steps Represent the Stages of a Connection

It's important to remember that this state machine is followed for **each connection**. This means at any given time TCP may be in one state for one connection to socket X, while in another for its connection to socket Y. Also, the typical movement between states for the two processes in a particular connection is not symmetric, because the roles of the devices are not symmetric: one device initiates a connection, the other responds; one device starts termination, the other replies. There is also an alternate path taken for connection establishment and termination if both devices initiate simultaneously (which is unusual, but can happen). This is shown by the color codings in [Figure 210](#).

Thus, for example, at the start of connection establishment, the two devices will take different routes to get to *ESTABLISHED*: one device (the server usually) will pass through the *LISTEN* state while the other (the client) will go through *SYN-SENT*. Similarly, one device will initiate connection termination and take the path through *FIN-WAIT-1* to get back to *CLOSED*; the other will go through *CLOSE-WAIT* and *LAST-ACK*. However, if both try to open at once, they each proceed through *SYN-SENT* and *SYN-RECEIVED*, and if both try to close at once, they go through *FIN-WAIT-1*, *CLOSING* and *TIME-WAIT* roughly simultaneously.



Key Concept: The TCP finite state machine describes the sequence of steps taken by both devices in a TCP session as they establish, manage and close the connection. Each device may take a different path through the states since under normal circumstances the operation of the protocol is not symmetric—one device initiates either connection establishment or termination, and the other responds.

TCP Connection Preparation: Transmission Control Blocks (TCBs) and Passive and Active Socket *OPENS*

In [the TCP fundamentals topic describing ports and connections](#), I raised an important point about TCP operation: it must be capable of handling many connections simultaneously. It is for this reason that we uniquely identify each connection using the *quadruple* of the socket identifiers (IP address and port number) for each of the two devices on the connection. The process of setting up, managing and terminating a connection is performed independently for each connection.

Storing Connection Data: the Transmission Control Block

Since each connection is distinct, we must maintain data about each connection separately. TCP uses a special data structure for this purpose, called a *transmission control block (TCB)*. The TCB contains all the important information about the connection, such as the two socket numbers that identify it and pointers to buffers where incoming and outgoing data are held. The TCB is also used to implement the sliding window mechanism. It holds variables that keep track of the number of bytes received and acknowledged, bytes received and not yet acknowledged, current window size and so forth. Of course, each device maintains its own TCB for the connection.

Before the process of setting up a TCP connection can begin, the devices on each end must perform some “prep work”. One of the tasks required to prepare for the connection is to set up the TCB that will be used to hold information about it. This is done right at the very start of the connection establishment process, when each device just transitions out of the *CLOSED* state.

Active and Passive OPENs

TCP/IP is based on the client/server model of operation, and TCP connection setup is based on the existence of these roles as well. The client and server each prepare for the connection by performing an *OPEN* operation. However, there are two different kinds of *OPEN*:

- **Active OPEN:** A client process using TCP takes the “active role” and initiates the connection by actually sending a TCP message to start the connection (a *SYN* message).
- **Passive OPEN:** A server process designed to use TCP, however, takes a more “laid-back” approach. It performs a *passive OPEN* by contacting TCP and saying “I am here, and I am waiting for clients that may wish to talk to me to send me a message on the following port number”. The *OPEN* is called *passive* because aside from indicating that the process is listening, the server process does nothing.

A passive *OPEN* can in fact specify that the server is waiting for an active *OPEN* from a specific client, though not all TCP/IP APIs support this capability. More commonly, a server process is willing to accept connections from all comers. Such a passive *OPEN* is said to be *unspecified*.



Key Concept: A client process initiates a TCP connection by performing an active *OPEN*, sending a *SYN* message to a server. A server process using TCP prepares for an incoming connection request by performing a passive *OPEN*. Both devices create for each TCP session a data structure used to hold important data related to the connection, called a *transmission control block (TCB)*.

Preparation For Connection

Both the client and the server create the TCB for the connection at the time that they perform the *OPEN*. The client already knows the IP addresses and port numbers for both the client process and the server process it is trying to reach, so it can use these to uniquely identify the connection and the TCB that goes with it.

For the server, the concept of a TCB at this stage of the game is a bit more complex. If the server is in fact waiting for a particular client, it can identify the connection using its own socket and the socket of the client for which it is waiting. Normally, however, the server doesn't know what client is trying to reach it. In fact, it could be contacted by more than one client nearly at the same time.

In this case, the server creates a TCB with an unspecified (zero) client socket number, and waits for an active *OPEN* to be received. It then *binds* the socket number of the client to the TCB for the passive *OPEN* as part of the connection process. To allow it to handle multiple incoming connections, the server process may in fact perform several unspecified passive *OPENs* simultaneously.

The transmission control block for a connection is maintained throughout the connection and destroyed when the connection is completely terminated and the device returns to the *CLOSED* state. TCP does include a procedure to handle the situation where both devices perform an active *OPEN* simultaneously. This is discussed in more detail in [the next topic on the connection establishment process](#).

TCP Connection Establishment Process: The "Three-Way Handshake"

We have discussed in earlier topics in this section the connection orientation of TCP and its operation. Before TCP can be employed for any actually useful purpose—that is, sending data—a connection must be set up between the two devices that wish to communicate. This process, usually called *connection establishment*, involves an exchange of messages that transitions both devices from their initial connection state (*CLOSED*) to the normal operating state (*ESTABLISHED*).

Connection Establishment Functions

The connection establishment process actually accomplishes several things as it creates a connection suitable for data exchange:

- ④ **Contact and Communication:** The client and server make contact with each other and establish communication by sending each other messages. The server usually doesn't even know what client it will be talking to before this point, so it discovers this during connection establishment.
- ④ **Sequence Number Synchronization:** Each device lets the other know what [initial sequence number](#) it wants to use for its first transmission.
- ④ **Parameter Exchange:** Certain [parameters that control the operation of the TCP connection are exchanged](#) by the two devices.

Control Messages Used for Connection Establishment: SYN and ACK

TCP uses control messages to manage the process of contact and communication. There aren't, however, any special TCP control message types; all TCP messages use [the same segment format](#). A set of control flags in the TCP header indicates whether a segment is being used for control purposes or just to carry data. As I introduced in [the discussion of the TCP finite state machine](#), two control message types are used in connection setup, which are specified by setting the following two flags:

- ☉ **SYN:** This bit indicates that the segment is being used to initialize a connection. *SYN* stands for *synchronize*, in reference to the sequence number synchronization I mentioned above.
- ☉ **ACK:** This bit indicates that the device sending the segment is conveying an *acknowledgment* for a message it has received (such as a *SYN*).

There are also other control bits (*FIN*, *RST*, *PSH* and *URG*), which aren't important to connection establishment, so we will set them aside for now. We'll discuss them in other topics. In common TCP parlance, a message with a control bit set is often named for that bit. For example, if the *SYN* control bit is set the segment is often called "a *SYN* message". Similarly, one with the *ACK* bit set is "an *ACK* message" or even just "an *ACK*".

Normal Connection Establishment: The "Three Way Handshake"

To establish a connection, each device must send a *SYN* and receive an *ACK* for it from the other device. Thus, conceptually, we need to have four control messages pass between the devices. However, it's inefficient to send a *SYN* and an *ACK* in separate messages when one could communicate both simultaneously. Thus, in the normal sequence of events in connection establishment, one of the *SYNs* and one of the *ACKs* is sent together by setting both of the relevant bits (a message sometimes called a *SYN+ACK*). This makes a total of three messages, and for this reason the connection procedure is called a *three-way handshake*.



Key Concept: The normal process of establishing a connection between a TCP client and server involves three steps: the client sends a *SYN* message; the server sends a message that combines an *ACK* for the client's *SYN* and contains the server's *SYN*; and then the client sends an *ACK* for the server's *SYN*. This is called the *TCP three-way handshake*.

[Table 153](#) describes in detail how the three-way handshake works (including a summary of [the preparation discussed in the previous topic](#)). It is adapted from [the table describing the TCP finite state machine](#), but shows what happens for both the server and the client over time. Each row shows the state the device begins in, what action it takes in that state and the state to which it transitions. The transmit and receive parts of each of the three steps of the handshake process are shown in the table, as well as in [Figure 211](#).

Table 153: TCP “Three-Way Handshake” Connection Establishment Procedure

Client			Server		
Start State	Action	Move To State	Start State	Action	Move To State
CLOSED	The client cannot do anything until the server has performed a passive <i>OPEN</i> and is ready to accept a connection. (Well, it can try, but nothing will be accomplished until the server is ready.)	—	CLOSED	The server performs a passive <i>OPEN</i> , creating a transmission control block (TCB) for the connection and readying itself for the receipt of a connection request (<i>SYN</i>) from a client.	LISTEN
CLOSED	Step #1 Transmit: The client performs an active <i>OPEN</i> , creating a transmission control block (TCB) for the connection and sending a <i>SYN</i> message to the server.	SYN-SENT	LISTEN	The server waits for contact from a client.	—
SYN-SENT	The client waits to receive an <i>ACK</i> to the <i>SYN</i> it has sent, as well as the server's <i>SYN</i> .	—	LISTEN	Step #1 Receive, Step #2 Transmit: The server receives the <i>SYN</i> from the client. It sends a single <i>SYN+ACK</i> message back to the client that contains an <i>ACK</i> for the client's <i>SYN</i> , and the server's own <i>SYN</i> .	SYN-RECEIVED
SYN-SENT	Step #2 Receive, Step #3 Transmit: The client receives from the server the <i>SYN+ACK</i> containing the <i>ACK</i> to the client's <i>SYN</i> , and the <i>SYN</i> from the server. It sends the server an <i>ACK</i> for the server's <i>SYN</i> . The client is now done with the connection establishment.	ESTABLISHED	SYN-RECEIVED	The server waits for an <i>ACK</i> to the <i>SYN</i> it sent previously.	—
ESTABLISHED	The client is waiting for the server to finish connection establishment so they can operate normally.		SYN-RECEIVED	Step #3 Receive: The server receives the <i>ACK</i> to its <i>SYN</i> and is now done with connection establishment.	ESTABLISHED
ESTABLISHED	The client is ready for normal data transfer operations.		ESTABLISHED	The server is ready for normal data transfer operations.	

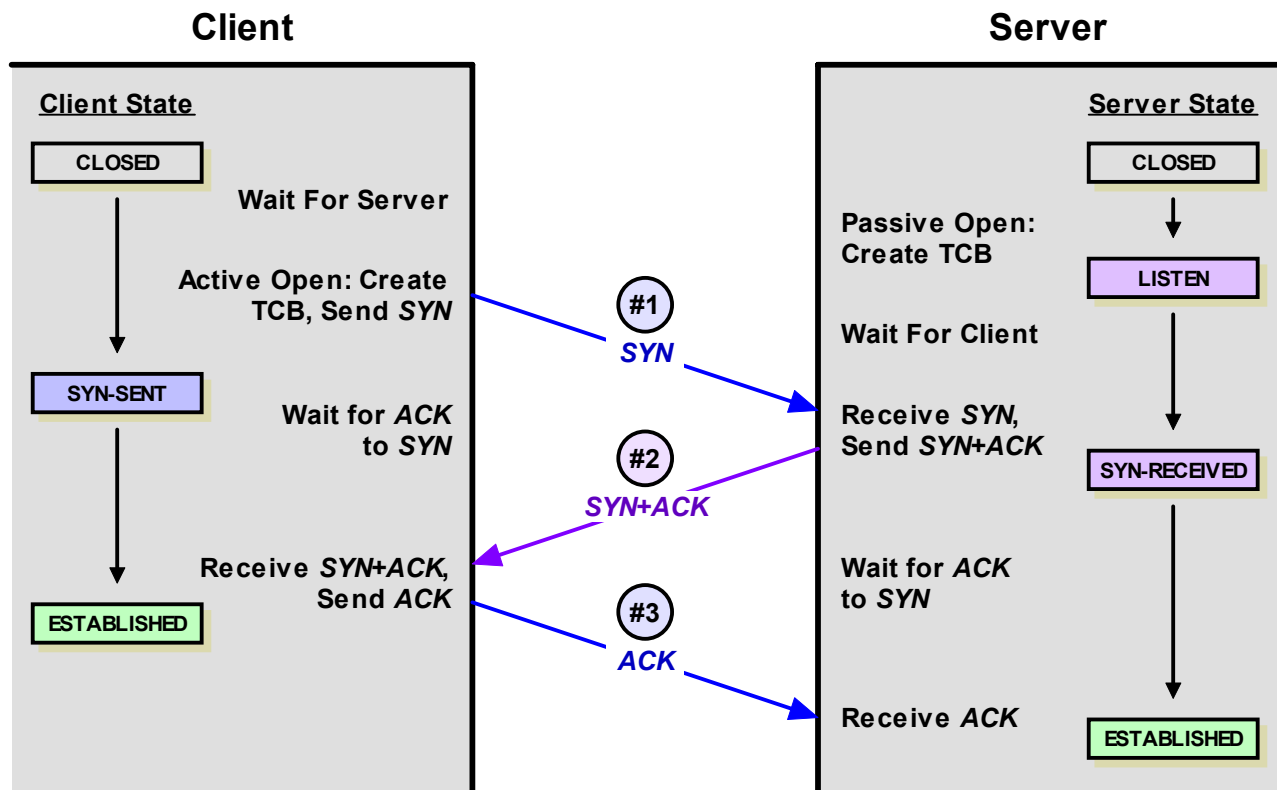

Figure 211: TCP “Three-Way Handshake” Connection Establishment Procedure

This diagram illustrates how a conventional connection is established between a client and server, showing the three messages sent during the process and how each device transitions from the *CLOSED* state through intermediate states until the session is *ESTABLISHED*.

Simultaneous Open Connection Establishment

TCP is also set up to handle the situation where both devices perform an active *OPEN* instead of one doing a passive *OPEN*. This may occur if two clients are trying to reach each other instead of a client and a server. It is uncommon, however, and only happens under certain circumstances. Simultaneous connection establishment can also only happen if a well-known port is used as the source port for one of the devices.

In this case, the steps are different for both devices. Each client will perform an active *OPEN* and then proceed through both the *SYN-SENT* and *SYN-RECEIVED* states until their *SYNs* are acknowledged. This means there isn't a “three-way handshake” any more as shown in [Table 153](#). Instead, it is like two simultaneous “two-way handshakes”. Each client sends a *SYN*, receives the other's *SYN* and *ACKs* it, and then waits for its own *ACK*. The transaction, simplified, is described in [Table 154](#) and [Figure 212](#).

Table 154: TCP Simultaneous Open Connection Establishment Procedure

Client A			Client B		
Start State	Action	Move To State	Start State	Action	Move To State
CLOSED	Client A Step #1 Transmit: Client A performs an active <i>OPEN</i> , creating a TCB and sending a <i>SYN</i> message to the server.	SYN-SENT	CLOSED	Client B Step #1 Transmit: Client B performs an active <i>OPEN</i> , creating a TCB and sending a <i>SYN</i> to the server.	SYN-SENT
SYN-SENT	Client B Step #1 Receive and Step #2 Transmit: Client A receives Client B's <i>SYN</i> and sends it an <i>ACK</i> . It is still waiting for an <i>ACK</i> to its own <i>SYN</i> .	SYN-RECEIVED	SYN-SENT	Client A Step #1 Receive and Step #2 Transmit: Client B receives Client A's <i>SYN</i> and sends it an <i>ACK</i> . It is still waiting for an <i>ACK</i> to its own <i>SYN</i> .	SYN-RECEIVED
SYN-RECEIVED	Client A Step #2 Receive: Client A receives the <i>ACK</i> from Client B for its <i>SYN</i> and is done with connection establishment.	ESTABLISHED	SYN-RECEIVED	Client B Step #2 Receive: Client B receives the <i>ACK</i> from Client A for its <i>SYN</i> and is done with connection establishment.	ESTABLISHED

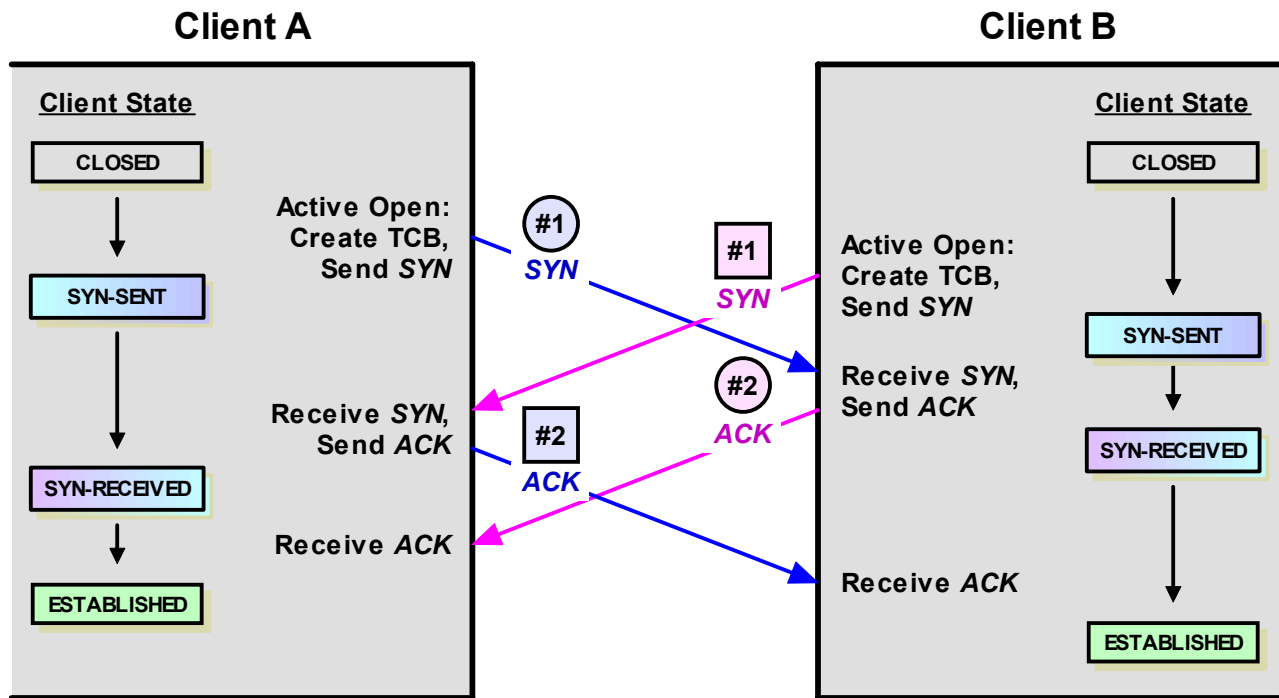

Figure 212: TCP Simultaneous Open Connection Establishment Procedure

This diagram shows what happens when two devices try to open a connection to each other at the same time. In this case instead of a three-way handshake, each sends a *SYN* and receives an *ACK*. They each follow the same sequence of states, which differs from both sequences in the normal three-way handshake.

To keep the table size down, I have shown the activities performed by the two devices occurring simultaneously (in the same row). In “real life” the actions don’t need to occur at exactly the same time, and probably won’t. All that has to happen for the simultaneous procedure to be followed is that each device receives a SYN before getting an ACK for their own SYN, as [Figure 212](#) shows.



Key Concept: If one device setting up a TCP connection sends a *SYN* and then receives a *SYN* from the other one before its *SYN* is acknowledged, the two devices perform a *simultaneous open*, which consists of the exchange of two independent *SYN* and *ACK* message sets. The end result is the same as the conventional three-way handshake, but the process of getting to the *ESTABLISHED* state is different.

TCP Connection Establishment Sequence Number Synchronization and Parameter Exchange

The [TCP three-way handshake](#) describes the mechanism of message exchange that allows a pair of TCP devices to move from a closed state to a ready-to-use, established connection. Connection establishment is about more than just passing messages between devices to establish communication. The TCP layers on the devices must also exchange information about the sequence numbers each device wants to use for its first data transmission, as well as parameters that will control how the connection operates. The former of these two data exchange functions is usually called *sequence number synchronization*, and is such an important part of connection establishment that the messages that each device sends to start the connection are called *SYN (synchronization)* messages.

You may recall from the TCP fundamentals section that [TCP refers to each byte of data individually](#), and [uses sequence numbers to keep track of which bytes have been sent and received](#). Since each byte has a sequence number, we can acknowledge each byte, or more efficiently, use a single number to acknowledge a range of bytes received.

The Problem With Starting Every Connection Using the Same Sequence Number

In the example I gave in [the topic describing the sliding windows system](#), I assumed for “simplicity” (ha ha, was that simple?) that each device would start a connection by giving the first byte of data sent sequence number 1. A valid question is, why wouldn’t we ***always*** just start off each TCP connection by sending the first byte of data with a sequence number of 1? The sequence numbers are arbitrary, after all, and this is the simplest method.

In an ideal world, this would probably work, but we don’t live in an ideal world. ☺ The problem with starting off each connection with a sequence number of 1 is that it introduces the possibility of segments from different connections getting mixed up. Suppose we established a TCP connection and sent a segment containing bytes 1 through 30. However, there was a problem with the internetwork that caused this segment to be delayed, and eventually, the TCP connection itself to be terminated. We then started up a new

connection and again used a starting sequence number of 1. As soon as this new connection was started, however, the old segment with bytes labeled 1 to 30 showed up. The other device would erroneously think those bytes were part of the **new** connection.

This is but one of several similar problems that can occur. To avoid them, each TCP device, at the time a connection is initiated, chooses a 32-bit *initial sequence number (ISN)* for the connection. Each device has its own ISN, and they will normally not be the same.

Selecting the Initial Sequence Number

Traditionally, each device chose the ISN by making use of a timed counter, like a clock of sorts, that was incremented every 4 microseconds. This counter was initialized when TCP started up and then its value increased by 1 every 4 microseconds until it reached the largest 32-bit value possible (4,294,967,295) at which point it “wrapped around” to 0 and resumed incrementing. Any time a new connection is set up, the ISN was taken from the current value of this timer. Since it takes over 4 hours to count from 0 to 4,294,967,295 at 4 microseconds per increment, this virtually assured that each connection will not conflict with any previous ones.

One issue with this method is that it makes ISNs predictable. A malicious person could write code to analyze ISNs and then predict the ISN of a subsequent TCP connection based on the ISNs used in earlier ones. This represents a security risk, which has been exploited in the past (such as in the case of the famous Mitnick attack). To defeat this, implementations now use a random number in their ISN selection process.

TCP Sequence Number Synchronization

Once each device has chosen its ISN, it sends this value to the other device in the *Sequence Number* field in its initial *SYN* message. The device receiving the *SYN* responds with an *ACK* message acknowledging the *SYN* (which may also contain its own *SYN*, as in step #2 of the three-way handshake). In the *ACK* message, the *Acknowledgment Number* field is set to the value of the ISN received from the other device **plus one**. This represents the next sequence number the device expects to receive from its peer; the ISN actually thus represents the sequence number of the last byte received (fictitious in this case, since the connection is new and nothing yet has been received). We'll see later on that [this is consistent with how these two fields are used for normal data exchange](#).



Key Concept: As part of the process of connection establishment, each of the two devices in a TCP connection informs the other of the sequence number it plans to use for its first data transmission by putting the preceding sequence number in the *Sequence Number* field of its *SYN* message. The other device confirms this by incrementing that value and putting it into the *Acknowledgment Number* field of its *ACK*, telling the other device that is the sequence number it is expecting for the first data transmission. This process is called *sequence number synchronization*.

Here's a simplified example of the three-way handshake steps showing how this is done (see [Figure 213](#) as well). I chose small ISNs for readability but remember that they can be any 32-bit number:

1. **Connection Request By Client:** The client chooses an ISN for its transmissions of 4,567. It sends a *SYN* with the *Sequence Number* field set to 4,567.
2. **Acknowledgment and Connection Request By Server:** The server chooses an ISN for its transmissions of 12,998. It receives the client's *SYN*. It sends a *SYN+ACK* with an *Acknowledgment Number* field value of 4,568 (one more than the client's ISN). This message has a *Sequence Number* field value of 12,998.
3. **Acknowledgment By Client:** The client sends an *ACK* with the *Acknowledgment Number* field set to 12,999.

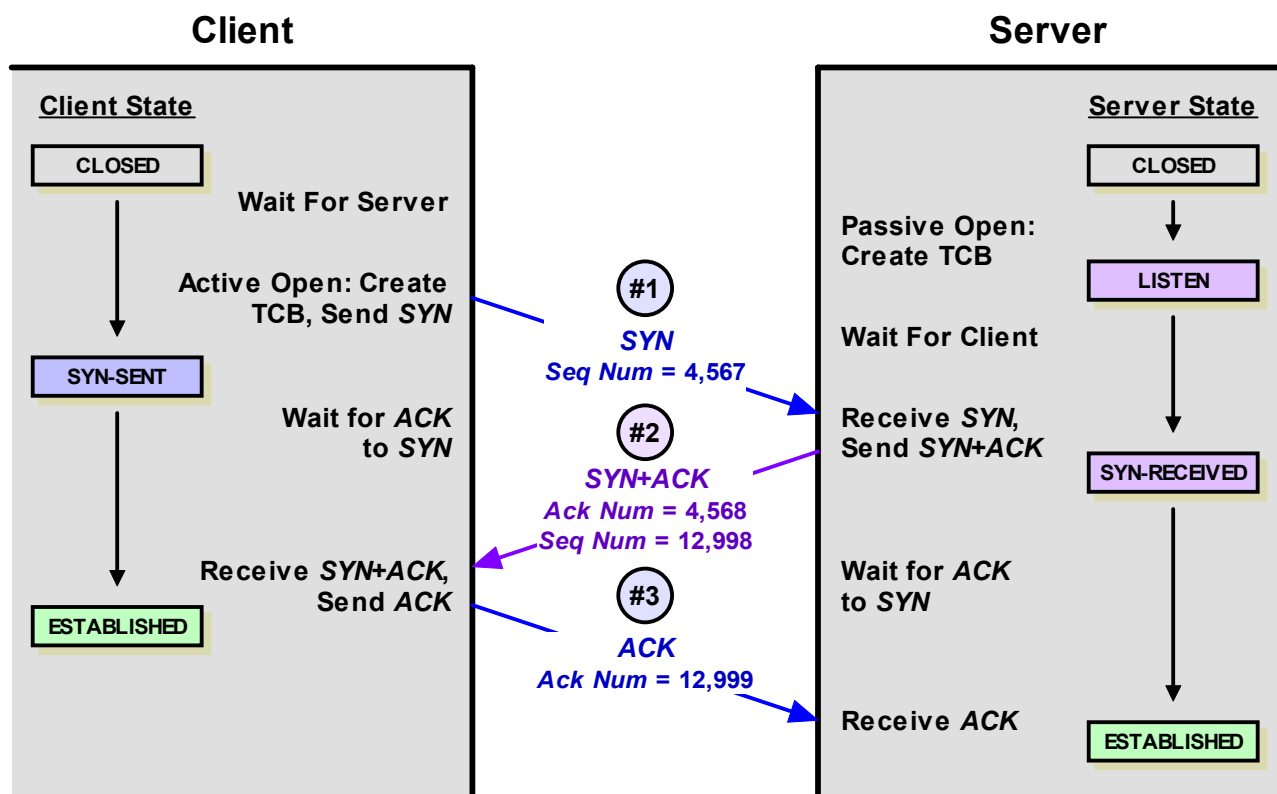

Figure 213: TCP Sequence Number Synchronization

This diagram illustrates the same three-way handshake connection establishment procedure introduced in [Figure 211](#), except this time I have shown the *Sequence Number* and *Acknowledgment Number* fields in each message so you can see how they are used by each of the two devices to establish initial sequence numbers for data exchange.

With the connection now established, the client will send data whose first byte will be given sequence number 4,568. The server's first byte of data will be numbered 12,999.

TCP Parameter Exchange

In addition to initial sequence numbers, *SYN* messages also are designed to convey important parameters about how the connection should operate. TCP includes a flexible scheme for carrying these parameters, in the form of a variable-length *Options* field in the TCP segment format that can be expanded to carry multiple parameters. Only a single parameter is defined in TCP 793 to be exchanged during connection setup: *Maximum Segment Size (MSS)*. [The significance of this parameter is explained in the TCP data transfer section.](#)

Each device sends the other the MSS that it wants to use for the connection, if it wishes to use a non-default value. When receiving the *SYN*, the server records the MSS value that the client sent, and will never send a segment larger than that value to the client. The client does the same for the server. The client and server MSS values are independent, so a connection can be established where the client can receive larger segments than the server or vice-versa.

Later RFCs have defined additional parameters that may be exchanged during connection setup. Some of these include:

- ☉ **Window Scale Factor:** Allows a pair of devices to specify larger window sizes than would normally be possible given the 16-bit size of the TCP *Window* field.
- ☉ **Selective Acknowledgment Permitted:** Allows a pair of devices to use [the optional selective acknowledgment feature](#) to allow only certain lost segments to be retransmitted.
- ☉ **Alternate Checksum Method:** Lets devices specify an alternative method of performing checksums than [the standard TCP mechanism](#).

TCP Connection Management and Problem Handling, the Connection Reset Function, and TCP "Keepalives"

Once both of the devices in a TCP connection have completed connection setup and have entered the *ESTABLISHED* state, the TCP software is in its normal operating mode. Bytes of data will be packaged into segments for transmission using the mechanisms described in [the section on message formatting and data transfer](#). The [sliding windows scheme](#) will be used to control segment size and to provide flow control, congestion handling and retransmissions as needed.

Once in this mode, both devices can remain there indefinitely. Some TCP connections can be very long-lived indeed—in fact, some users maintain certain connections like [Telnet sessions](#) for hours or even days at a time. There are two circumstances that can cause a connection to move out of the *ESTABLISHED* state:

- ☉ **Connection Termination:** Either of the devices decides to terminate the connection. This involves [a specific procedure that is covered in the next topic in this section](#).
- ☉ **Connection Disruption:** A problem of some sort occurs that causes the connection to be interrupted.

The TCP Reset Function

To allow TCP to live up to its job of being a reliable and robust protocol, it includes intelligence that allows it to detect and respond to various problems that can occur during an established connection. One of the most common is the *half-open connection*. This situation occurs when due to some sort of problem, one device closes or aborts the connection without the other one knowing about it. This means one device is in the *ESTABLISHED* state while the other may be in the *CLOSED* state (no connection) or some other transient state. This could happen if, for example, one device had a software crash and was restarted in the middle of a connection, or if some sort of glitch caused the states of the two devices to become unsynchronized.

To handle half-open connections and other problem situations, TCP includes a special *reset function*. A reset is a TCP segment that is sent with the *RST* flag set to one in its header. Generally speaking, a reset is generated whenever something happens that is “unexpected” by the TCP software. Some of the most common specific cases in which a reset is generated include:

- ☉ Receipt of any TCP segment from any device with which the device receiving the segment does not currently have a connection (other than a *SYN* requesting a new connection.)
- ☉ Receipt of a message with an invalid or incorrect *Sequence Number* or *Acknowledgment Number* field, indicating the message may belong to a prior connection or is spurious in some other way.
- ☉ Receipt of a *SYN* message on a port where there is no process listening for connections.

Handling Reset Segments

When a device receives a segment with the *RST* bit sent, it tells the device to reset the connection so it can be re-established. Like all segments, the reset itself must be checked to ensure that it is valid (by looking at the value of its *Sequence Number* field). This prevents a spurious reset from shutting down a connection. Assuming the reset is valid, the handling of the message depends on the state of the device that receives it:

- ☉ If the device is in the *LISTEN* state, the reset is ignored and it remains in that state.
- ☉ If the device is in the *SYN-RECEIVED* state but was previously in the *LISTEN* state (which is the normal course of events for a server setting up a new connection), it returns to the *LISTEN* state.
- ☉ In any other situation, the reset causes the connection to be aborted and the device returns to the *CLOSED* state for that connection. The device will advise the higher-layer process using TCP that the connection has been closed.



Key Concept: TCP includes a special *connection reset feature* to allow devices to deal with problem situations, such as half-open connections or the receipt of unexpected message types. To use the feature, the device detecting the problem sends a TCP segment with the *RST* (reset) flag set to 1. The receiving device either returns to the *LISTEN* state, if it was in the process of connection establishment, or closes the connection and returns to the *CLOSED* state pending a new session negotiation.

Idle Connection Management and "Keepalive" Messages

One final connection management issue in TCP is how to handle an idle connection; that is, a TCP session that is active but that has no data being transmitted by either device for a prolonged period of time. The TCP standard specifies that the appropriate action to take in this situation is... nothing. The reason is that, strictly speaking, there is no need to do anything to maintain an idle connection in TCP. The protocol is perfectly happy to allow both devices to stop transmitting for a very long period of time, and then simply resume transmissions of data and acknowledgment segments when either has data to send.

However, just as many people become “antsy” when they are on a telephone call and they don’t hear anything for a long while, there was concern on the part of some TCP implementors that a TCP connection that was idle for a very long while might mean that the connection had been broken.

Thus, TCP software often includes an “unofficial” feature that allows a device with a TCP link to periodically send a null segment containing no data to its peer on the connection. If the connection is still valid, the other device responds with a segment containing an acknowledgment; if it is not, the other device will reply with a connection reset segment as described above. These segments sometimes called TCP “*keepalive*” messages, or just “*keepalives*”. They are analogous to [BGP Keepalive messages](#).

The use of these messages is quite controversial, and therefore, not universal. Those who are opposed to them argue that they are not really necessary, and that sending them represents a waste of internetwork bandwidth and a possible additional cost on metered links (those that charge for each datagram sent.) Their key point is that if the connection is not presently being used, it doesn’t matter if it is still valid or not; as soon as the connection is used again, if it has broken in the mean time, TCP can handle that using the reset function mentioned above.

Worse, sending a “keepalive” can in theory cause a good TCP session to be unnecessarily broken. This may happen if the “keepalive” is sent during a time when there is an intermittent failure between the client and server, a failure that might otherwise have corrected itself by the time the next piece of “real” data must be sent. In addition, some TCP implementations may not properly deal with the receipt of these segments.

Those in favor of using “keepalives” point out that each TCP connection consumes a certain amount of resources, and this can be an issue especially for busy servers. If many clients connect to such a server and don’t terminate the TCP connection properly, the server may sit for a long time with an idle connection, using system memory and other resources that could be applied elsewhere.

Since there is no wide acceptance on the use of this feature, devices implementing it include a way to disable it if necessary. Devices are also programmed so they will not terminate a connection simply as a result of not receiving a response to a single “keepalive”. They may do so if they do not receive a reply after several such messages have been sent over a period of time.

TCP Connection Termination

As the saying goes, “all good things must come to an end”... and so it is with TCP connections. The link between a pair of devices can remain open for a considerable period of time, assuming that a problem doesn't [force the connection to be aborted](#). Eventually, however, one or both of the processes in the connection will run out of data to send and will shut down the TCP session, or will be instructed by the user to do so.

Requirements and Issues In Connection Termination

Just as TCP follows [an ordered sequence of operations to establish a connection](#), it includes a specific procedure for terminating a connection. As with connection establishment, each of the devices moves from one state to the next to terminate the connection. This process is more complicated than one might imagine it needs to be. In fact, an examination of the [TCP finite state machine](#) shows that there are more distinct states involved in shutting down a connection than in setting one up.

The reason that connection termination is complex is that during normal operation, both of the devices are sending and receiving data simultaneously. Usually, connection termination begins with the process on just one device indicating to TCP that it wants to close the connection. The matching process on the other device may not be aware that its peer wants to end the connection at all. Several steps are required to ensure that the connection is shut down gracefully by both devices, and that no data is lost in the process.

Ultimately, shut down of a TCP connection requires that the application processes on both ends of the connection recognize that “the end is nigh” for the connection and stop sending data. For this reason, connection termination is implemented so that each device terminates its end of the connection separately. The act of closing the connection by one device means that device will no longer send data, but can continue to receive it until the other device has decided to stop sending. This allows all data that is pending to be sent by both sides of the communication to be flushed before the connection is ended.

Normal Connection Termination

In the normal case, each side terminates its end of the connection by sending a special message with the *FIN* (*finish*) bit set. This message, sometimes called a *FIN*, serves as a connection termination request to the other device, while also possibly carrying data like a regular segment. The device receiving the *FIN* responds with an acknowledgment to the *FIN* to indicate that it was received. The connection as a whole is not considered terminated until both sides have finished the shut down procedure by sending a *FIN* and receiving an *ACK*.

Thus, termination isn't a three-way handshake like establishment: it is a pair of two-way handshakes. The states that the two devices in the connection move through during a normal connection shutdown are different because the device initiating the shutdown must behave differently than the one that receives the termination request. In particular, the TCP on the device receiving the initial termination request must inform its application process and wait for a signal that the process is ready to proceed. The initiating device doesn't need to do this, since the application is what started the ball rolling in the first place.



Key Concept: A TCP connection is normally terminating using a special procedure where each side independently closes its end of the link. It normally begins with one of the application processes signalling to its TCP layer that the session is no longer needed. That device sends a *FIN* message to tell the other device that it wants to end the connection, which is acknowledged. When the responding device is ready, it too sends a *FIN* that is acknowledged; after waiting a period of time for the *ACK* to be received, the session is closed.

[Table 155](#) describes in detail how the connection termination process works; the progression of states and messages exchanged can also be seen in [Figure 214](#). The table is adapted from [Table 152](#), describing the TCP finite state machine, but shows what happens for both the server and the client over time during connection shutdown. Either device can initiate connection termination; in this example I am assuming the client does it. Each row shows the state each device begins in, what action it takes in that state and what state to which it transitions. I have also shown the send and receive stages of both of the steps for each of the client and server's close operations.

Table 155: TCP Connection Termination Procedure

Client			Server		
Start State	Action	Transitions To State	Start State	Action	Transitions To State
ESTABLISHED	Client Close Step #1 Transmit: The application using TCP signals that the connection is no longer needed. The client TCP sends a segment with the <i>FIN</i> bit set to request that the connection be closed.	FIN-WAIT-1	ESTABLISHED	At this stage the server is still in normal operating mode.	—
FIN-WAIT-1	The client, having sent a <i>FIN</i> , is waiting for it to both be acknowledged and for the server to send its own <i>FIN</i> . In this state the client can still receive data from the server but will no longer accept data from its local application to be sent to the server.	—	ESTABLISHED	Client Close Step #1 Receive and Step #2 Transmit: The server receives the client's <i>FIN</i> . It sends an <i>ACK</i> to acknowledge the <i>FIN</i> . The server must wait for the application using it to be told the other end is closing, so the application here can finish what it is doing.	CLOSE-WAIT
FIN-WAIT-1	Client Close Step #2 Receive: The client receives the <i>ACK</i> for its <i>FIN</i> . It must now wait for the server to close.	FIN-WAIT-2	CLOSE-WAIT	The server waits for the application process on its end to signal that it is ready to close.	—
FIN-WAIT-2	The client is waiting for the server's <i>FIN</i> .	—	CLOSE-WAIT	Server Close Step #1 Transmit: The server's TCP receives notice from the local application that it is done. The server sends its <i>FIN</i> to the client.	LAST-ACK
FIN-WAIT-2	Server Close Step #1 Receive and Step #2 Transmit: The client receives the server's <i>FIN</i> and sends back an <i>ACK</i> .	TIME-WAIT	LAST-ACK	The server is waiting for an <i>ACK</i> for the <i>FIN</i> it sent.	—
TIME-WAIT	The client waits for a period of time equal to double the maximum segment life (MSL) time, to ensure the <i>ACK</i> it sent was received.	—	LAST-ACK	Server Close Step #2 Receive: The server receives the <i>ACK</i> to its <i>FIN</i> and closes the connection.	CLOSED
TIME-WAIT	The timer expires after double the MSL time.	CLOSED	CLOSED	The connection is closed on the server's end.	
CLOSED	The connection is closed.		CLOSED	The connection is closed.	

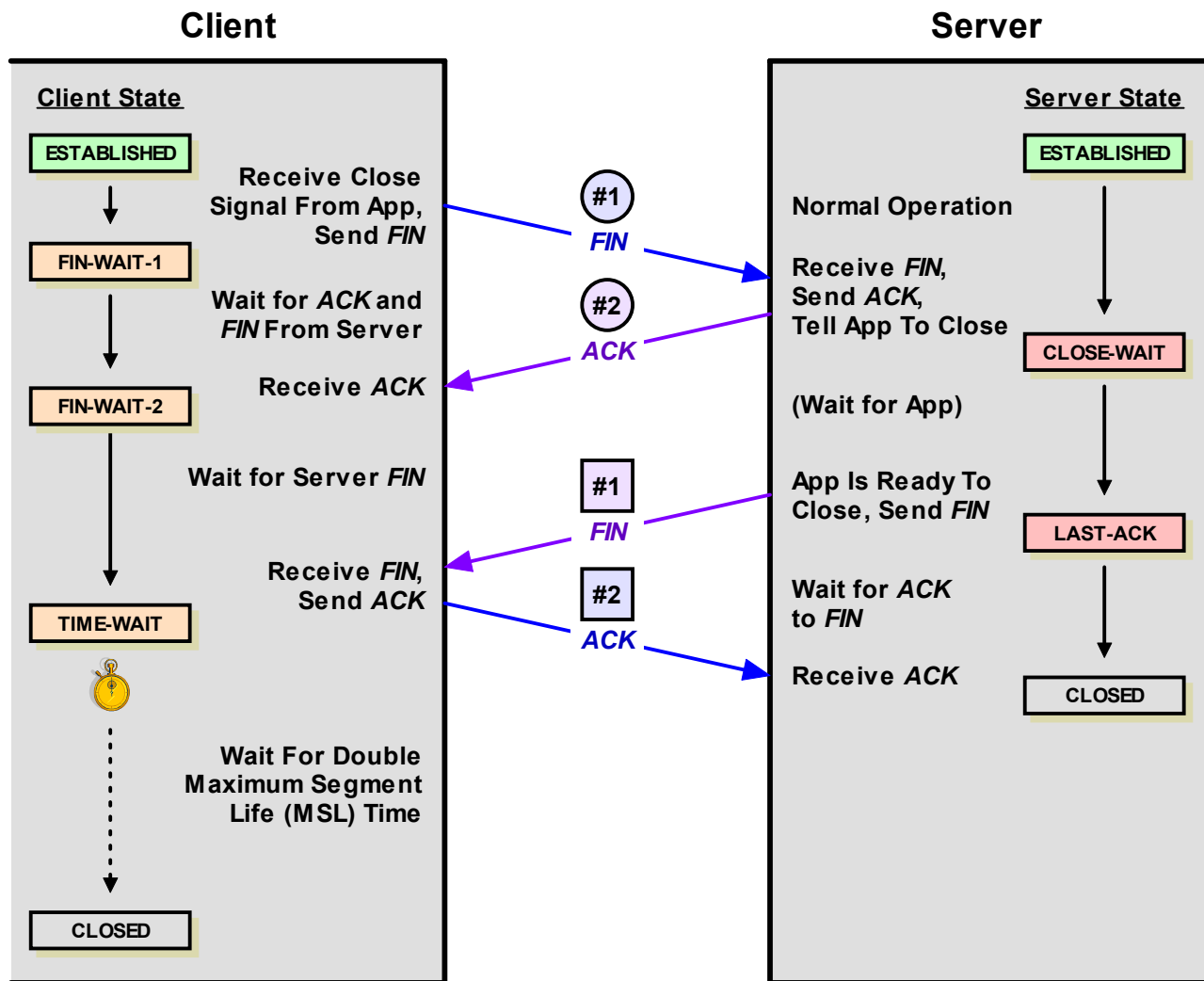

Figure 214: TCP Connection Termination Procedure

This diagram shows the conventional termination procedure for a TCP session, with one device initiating termination and the other responding. In this case the client initiates; it sends a *FIN* which is acknowledged by the server. The server waits for the server process to be ready to close and then sends its *FIN*, which is acknowledged by the client. The client waits for a period of time to ensure that its *ACK* is received, before proceeding to the *CLOSED* state.

The *TIME-WAIT* State

The device receiving the initial *FIN* may have to wait a fairly long time (in networking terms) in the *CLOSE-WAIT* state for the application it is serving to indicate that it is ready to shut down. TCP cannot make any assumptions about how long this will take. During this period of time, the server in our example above may continue sending data, and the client will receive it. However, the client will not send data to the server.

Eventually, the second device (the server in our example) will send a *FIN* to close its end of the connection. The device that originally initiated the close (the client above) will send an *ACK* for this *FIN*. However, the client cannot immediately go to the *CLOSED* state right after sending that *ACK*. The reason is that it must allow time for the *ACK* to travel to the server. Normally this will be quick, but delays might result in it being slowed down somewhat.

The *TIME-WAIT* state is required for two main reasons. The first is to provide enough time to ensure that the *ACK* is received by the other device, and to retransmit it if it is lost. The second is to provide a “buffering period” between the end of this connection and any subsequent ones. If not for this period, it is possible that packets from different connections could be mixed, creating confusion.

The standard specifies that the client should wait double a particular length of time called the *maximum segment lifetime (MSL)* before finishing the close of the connection. The TCP standard defines *MSL* as being a value of 120 seconds (2 minutes). In modern networks this is an eternity, so TCP allows implementations to choose a lower value if it is believed that will lead to better operation.

Simultaneous Connection Termination

Just as it is possible for the normal connection establishment process to be changed if two devices decide to actively *OPEN* a connection to each other, it is also possible for two devices to try to terminate a connection simultaneously. This term “simultaneously” doesn't mean that they both decide to shut down at exactly the same time—variances in network delays mean nothing can be simultaneous on an internetwork anyway. It simply means that, in the example above, the client decides to shut down and sends a *FIN*, but the server sends its own *FIN* before the client's *FIN* shows up at the server. In that case, a different procedure is followed, as described in [Table 156](#) and [Figure 215](#).

As you can see, the process is much more symmetric in this case, with both devices transitioning through the same states. In either case the end result is the same, with the connection in the *CLOSED* state—meaning no connection. Each TCP will make sure all outstanding data is sent to the application, sometimes referred to as an implied “push” ([see the description of the “push” function for an explanation of this term](#)). The transmission control blocks (TCBs) established for the connection in both devices are destroyed when the connection is closed down.

Table 156: TCP Simultaneous Connection Termination Procedure

Client			Server		
Start State	Action	Transitions To State	Start State	Action	Transitions To State
ESTABLISHED	Client Close Step #1 Transmit: The application using TCP signals that the connection is no longer needed. The TCP on the client sends the next segment with the <i>FIN</i> bit set, indicating a request to close the connection.	FIN-WAIT-1	ESTABLISHED	Server Close Step #1 Transmit: Before the server can receive the <i>FIN</i> sent by the client, the application on the server also signals a close. The server also sends a <i>FIN</i> .	FIN-WAIT-1
FIN-WAIT-1	Server Close Step #1 Receive and Step #2 Transmit: The client has sent a <i>FIN</i> and is waiting for it to be acknowledged. Instead, it receives the <i>FIN</i> sent by the server. It acknowledges the server's close request with an <i>ACK</i> and continues to wait for its own <i>ACK</i> .	CLOSING	FIN-WAIT-1	Client Close Step #1 Receive and Step #2 Transmit: The server has sent a <i>FIN</i> and is waiting for it to be acknowledged. Instead, it receives the <i>FIN</i> sent by the client. It acknowledges the client's close request with an <i>ACK</i> and continues to wait for its own <i>ACK</i> .	CLOSING
CLOSING	Client Close Step #2 Receive: The client receives the <i>ACK</i> for its <i>FIN</i> .	TIME-WAIT	CLOSING	Server Close Step #2 Receive: The server receives the <i>ACK</i> for its <i>FIN</i> .	TIME-WAIT
TIME-WAIT	The client waits for a period of time equal to double the maximum segment life (MSL) time. This gives enough time to ensure the <i>ACK</i> it sent to the server was received.	—	TIME-WAIT	The server waits for a period of time equal to double the maximum segment life (MSL) time. This gives enough time to ensure the <i>ACK</i> it sent to the client was received.	—
TIME-WAIT	The timer expires after double the MSL time.	CLOSED	TIME-WAIT	The timer expires after double the MSL time.	CLOSED
CLOSED	The connection is closed.	—	CLOSED	The connection is closed.	—

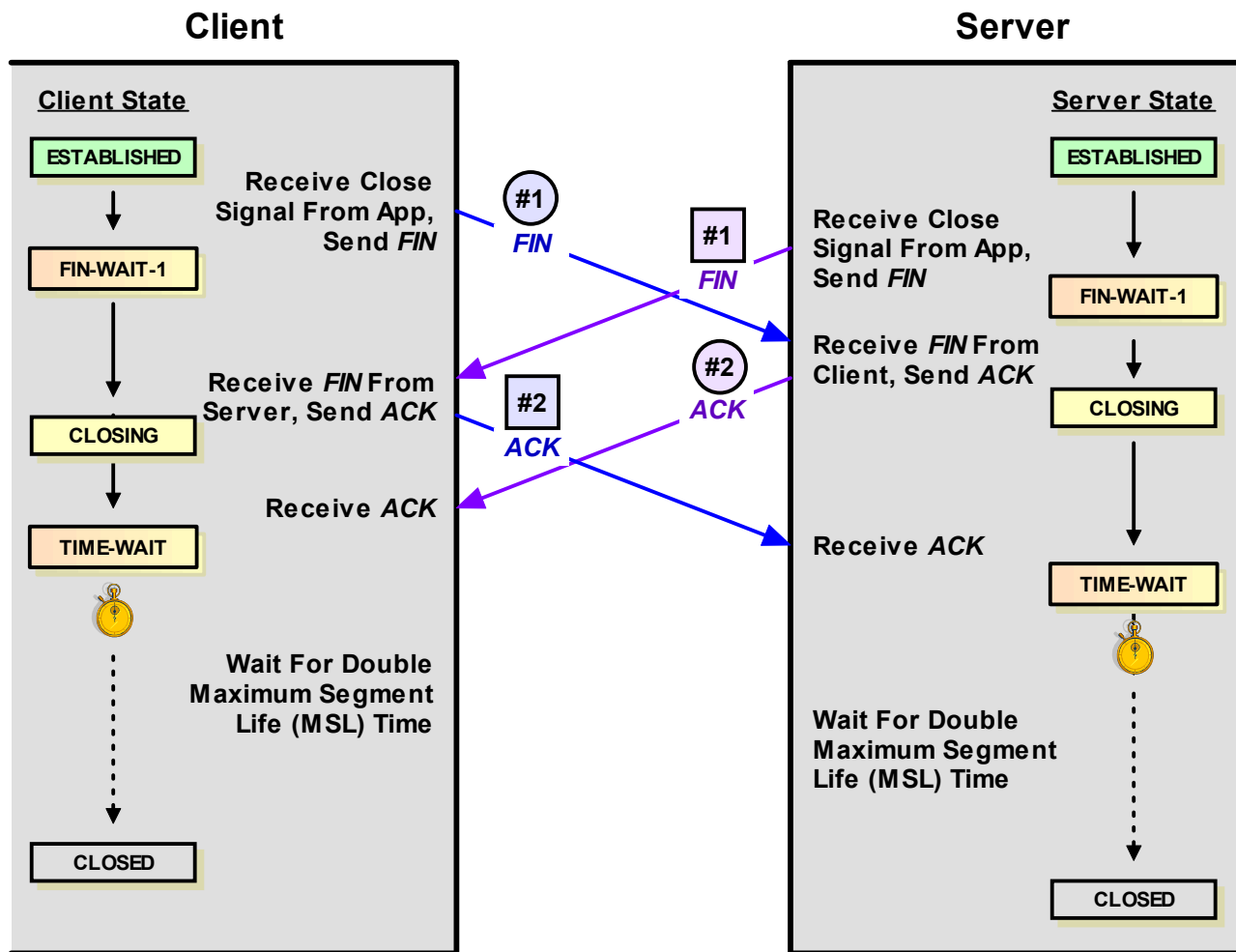

Figure 215: TCP Simultaneous Connection Termination Procedure

Under certain circumstances both devices may decide to terminate a connection simultaneously, or nearly simultaneously. In this case each sends a *FIN* and before getting an *ACK* for it, receives the other device's *FIN*. Each acknowledges the other's *FIN* with an *ACK*, and waits for a period of time before closing the connection. Note the transition through the **CLOSING** state, which is only used as part of simultaneous termination.



Key Concept: Just as two devices can simultaneously open a TCP session, they can terminate it simultaneously as well. In this case a different state sequence is followed, with each device responding to the other's *FIN* with an *ACK*, waiting for receipt of its own *ACK*, and pausing for a period of time to ensure that its *ACK* is received by the other device before ending the connection.



TCP Message Formatting and Data Transfer

The [previous section](#) described how two devices using the Transmission Control Protocol establish a TCP connection, as well as how that connection is managed and eventually terminated. While connections are a key part of how TCP works, they are really a means to the ultimate end of the protocol: sending data. Employing the TCP sliding window mechanism, a special segment format and several features, TCP devices are able to package and send data over the connection, enabling applications to communicate.

In this section, I describe the actual mechanism by which TCP messages are formatted and data is transferred between devices. I begin with a look at the important TCP segment format, which describes the fields in each TCP message and how they are used. I provide a description of the method used to calculate the checksum in TCP (as well as UDP) messages, and the reason why a special “pseudo header” is used. I discuss the Maximum Segment Size (MSS) parameter and its significance. I then talk about exactly how the sliding window mechanism is used to transfer and acknowledge data. I conclude with a description of two special data transfer features: the “push” feature for immediate data transfer, and the “urgent” feature for priority data transfer.



Background Information: This section assumes that you are already familiar with TCP concepts such as sequence numbers, segments, and the basics of the TCP sliding window mechanism. If you are not, I'd strongly recommend reading [the TCP fundamentals section](#) before proceeding here.

TCP Message (Segment) Format

In [the TCP fundamentals section](#), I described one of the most interesting jobs that TCP performs: it allows an application to send data as an unstructured sequence of bytes, transparently packaging that data in distinct messages as required by the underlying protocol that TCP uses (normally the Internet Protocol, of course). TCP messages are called *segments*, the name referring to the fact that each segment is a portion of the overall data stream passing between the devices.

Roles Performed by TCP Segments

TCP segments are very much “jack of all trade” messages—they are flexible and serve a variety of purposes. A single field format is used for all segments, with a number of header fields that implement the many functions and features for which TCP is responsible. One of the most notable characteristics of TCP segments is that they are designed to carry both control information and data simultaneously. This reduces the number of segments sent, since they can perform more than one function.

For example, there is no need to send separate acknowledgments in TCP because each TCP message includes a field for an acknowledgment byte number. Similarly, one can request that a connection be closed while sending data in the same message. The nature of

each TCP segment is indicated through the use of several special control bits. More than one bit can be sent to allow a segment to perform multiple functions, such as when a bit is used to specify an initial sequence number and acknowledge receipt of another such segment at the same time.

TCP Header Field Functions

The price we pay for this flexibility is that the TCP header is large: 20 bytes for regular segments and more for those carrying options. This is one of the reasons why some protocols prefer to use UDP if they don't need TCP's features. The TCP header fields are used for the following general purposes:

- ☉ **Process Addressing:** The processes on the source and destination devices are identified using port numbers.
- ☉ **Sliding Window System Implementation:** Sequence numbers, acknowledgment numbers and window size fields implement the [TCP sliding window system](#).
- ☉ **Control Bits and Fields:** Special bits that implement various control functions, and fields that carry pointers and other data needed for them.
- ☉ **Carrying Data:** The *Data* field carries the actual bytes of data being sent between devices.
- ☉ **Miscellaneous Functions:** A checksum for data protection and options for connection setup.

TCP Segment Format

The format for TCP messages (segments) is described fully in [Table 157](#) and [Figure 216](#).

Table 157: TCP Segment Format (Page 1 of 3)

Field Name	Size (bytes)	Description
Source Port	2	Source Port: The 16-bit port number of the process that originated the TCP segment on the source device. This will normally be an ephemeral (client) port number for a request sent by a client to a server, or a well-known/registered (server) port number for a reply from a server to a client.
Destination Port	2	Destination Port: The 16-bit port number of the process that is the ultimate intended recipient of the message on the destination device. This will usually be a well-known/registered (server) port number for a client request, or an ephemeral (client) port number for a server reply.
Sequence Number	4	Sequence Number: For normal transmissions, the sequence number of the first byte of data in this segment. In a connection request (<i>SYN</i>) message, this carries the initial sequence number (ISN) of the source TCP. The first byte of data will be given the next sequence number after the contents of this field, as described in the topic on sequence number synchronization .

Table 157: TCP Segment Format (Page 2 of 3)

Field Name	Size (bytes)	Description																					
Acknowledgment Number	4	Acknowledgment Number: When the <i>ACK</i> bit is set, this segment is serving as an acknowledgment (in addition to other possible duties) and this field contains the sequence number the source is next expecting the destination to send. See the topic describing TCP data transfer for details.																					
Data Offset	1/2 (4 bits)	Data Offset: Specifies the number of 32-bit words of data in the TCP header. In other words, this value times four equals the number of bytes in the header, which must always be a multiple of four. It is called a “data offset” since it indicates by how many 32-bit words the start of the data is offset from the beginning of the TCP segment.																					
Reserved	3/4 (6 bits)	Reserved: 6 bits reserved for future use; sent as zero.																					
Control Bits	3/4 (6 bits)	<p>Control Bits: As mentioned, TCP does not use a separate format for control messages. Instead, certain bits are set to indicate the communication of control information. The six bits are:</p> <table border="1"> <thead> <tr> <th>Subfield Name</th> <th>Size (bytes)</th> <th>Description</th> </tr> </thead> <tbody> <tr> <td>URG</td> <td>1/8 (1 bit)</td> <td>Urgent Bit: When set to 1, indicates that the priority data transfer feature has been invoked for this segment, and that the <i>Urgent Pointer</i> field is valid.</td> </tr> <tr> <td>ACK</td> <td>1/8 (1 bit)</td> <td>Acknowledgment Bit: When set to 1, indicates that this segment is carrying an acknowledgment, and the value of the <i>Acknowledgment Number</i> field is valid and carrying the next sequence expected from the destination of this segment.</td> </tr> <tr> <td>PSH</td> <td>1/8 (1 bit)</td> <td>Push Bit: The sender of this segment is using the TCP push feature, requesting that the data in this segment be immediately pushed to the application on the receiving device.</td> </tr> <tr> <td>RST</td> <td>1/8 (1 bit)</td> <td>Reset Bit: The sender has encountered a problem and wants to reset the connection.</td> </tr> <tr> <td>SYN</td> <td>1/8 (1 bit)</td> <td>Synchronize Bit: This segment is a request to synchronize sequence numbers and establish a connection; the <i>Sequence Number</i> field contains the initial sequence number (ISN) of the sender of the segment.</td> </tr> <tr> <td>FIN</td> <td>1/8 (1 bit)</td> <td>Finish Bit: The sender of the segment is requesting that the connection be closed.</td> </tr> </tbody> </table>	Subfield Name	Size (bytes)	Description	URG	1/8 (1 bit)	Urgent Bit: When set to 1, indicates that the priority data transfer feature has been invoked for this segment, and that the <i>Urgent Pointer</i> field is valid.	ACK	1/8 (1 bit)	Acknowledgment Bit: When set to 1, indicates that this segment is carrying an acknowledgment, and the value of the <i>Acknowledgment Number</i> field is valid and carrying the next sequence expected from the destination of this segment.	PSH	1/8 (1 bit)	Push Bit: The sender of this segment is using the TCP push feature , requesting that the data in this segment be immediately pushed to the application on the receiving device.	RST	1/8 (1 bit)	Reset Bit: The sender has encountered a problem and wants to reset the connection .	SYN	1/8 (1 bit)	Synchronize Bit: This segment is a request to synchronize sequence numbers and establish a connection ; the <i>Sequence Number</i> field contains the initial sequence number (ISN) of the sender of the segment.	FIN	1/8 (1 bit)	Finish Bit: The sender of the segment is requesting that the connection be closed .
Subfield Name	Size (bytes)	Description																					
URG	1/8 (1 bit)	Urgent Bit: When set to 1, indicates that the priority data transfer feature has been invoked for this segment, and that the <i>Urgent Pointer</i> field is valid.																					
ACK	1/8 (1 bit)	Acknowledgment Bit: When set to 1, indicates that this segment is carrying an acknowledgment, and the value of the <i>Acknowledgment Number</i> field is valid and carrying the next sequence expected from the destination of this segment.																					
PSH	1/8 (1 bit)	Push Bit: The sender of this segment is using the TCP push feature , requesting that the data in this segment be immediately pushed to the application on the receiving device.																					
RST	1/8 (1 bit)	Reset Bit: The sender has encountered a problem and wants to reset the connection .																					
SYN	1/8 (1 bit)	Synchronize Bit: This segment is a request to synchronize sequence numbers and establish a connection ; the <i>Sequence Number</i> field contains the initial sequence number (ISN) of the sender of the segment.																					
FIN	1/8 (1 bit)	Finish Bit: The sender of the segment is requesting that the connection be closed .																					
Window	2	Window: Indicates the number of octets of data the sender of this segment is willing to accept from the receiver at one time. This normally corresponds to the current size of the buffer allocated to accept data for this connection. This field is, in other words, the current receive window size for the device sending this segment, which is also the send window for the recipient of the segment. See the data transfer mechanics topic for details.																					

Table 157: TCP Segment Format (Page 3 of 3)

Field Name	Size (bytes)	Description												
Checksum	2	Checksum: A 16-bit checksum for data integrity protection, computed over the entire TCP datagram plus a special “pseudo header” of fields. It is used to protect the entire TCP segment against not just errors in transmission, but also errors in delivery. Optional alternate checksum methods are also supported.												
Urgent Pointer	2	Urgent Pointer: Used in conjunction with the <i>URG</i> control bit for priority data transfer. This field contains the sequence number of the last byte of urgent data. See the priority data transfer topic for details.												
Options	Variable	<p>Options: TCP includes a generic mechanism for including one or more sets of optional data in a TCP segment. Each of the options can be either one byte in length or variable in length. The first byte is the <i>Option-Kind</i> subfield, and its value specifies the type of option, which in turn indicates whether the option is just a single byte or multiple bytes. Options that are many bytes consist of three fields:</p> <table border="1"> <thead> <tr> <th>Subfield Name</th> <th>Size (bytes)</th> <th>Description</th> </tr> </thead> <tbody> <tr> <td><i>Option-Kind</i></td> <td>1</td> <td>Option-Kind: Specifies the option type.</td> </tr> <tr> <td><i>Option-Length</i></td> <td>1</td> <td>Option-Length: The length of the entire option in bytes, including the <i>Option-Kind</i> and <i>Option-Length</i> fields.</td> </tr> <tr> <td><i>Option-Data</i></td> <td>Variable</td> <td>Option-Data: The option data itself. In at least one oddball case, this field is omitted (making <i>Option-Length</i> equal to 2).</td> </tr> </tbody> </table>	Subfield Name	Size (bytes)	Description	<i>Option-Kind</i>	1	Option-Kind: Specifies the option type.	<i>Option-Length</i>	1	Option-Length: The length of the entire option in bytes, including the <i>Option-Kind</i> and <i>Option-Length</i> fields.	<i>Option-Data</i>	Variable	Option-Data: The option data itself. In at least one oddball case, this field is omitted (making <i>Option-Length</i> equal to 2).
Subfield Name	Size (bytes)	Description												
<i>Option-Kind</i>	1	Option-Kind: Specifies the option type.												
<i>Option-Length</i>	1	Option-Length: The length of the entire option in bytes, including the <i>Option-Kind</i> and <i>Option-Length</i> fields.												
<i>Option-Data</i>	Variable	Option-Data: The option data itself. In at least one oddball case, this field is omitted (making <i>Option-Length</i> equal to 2).												
Padding	Variable	Padding: If the <i>Options</i> field is not a multiple of 32 bits in length, enough zeroes are added to pad the header so it is a multiple of 32 bits.												
Data	Variable	Data: The bytes of data being sent in the segment.												

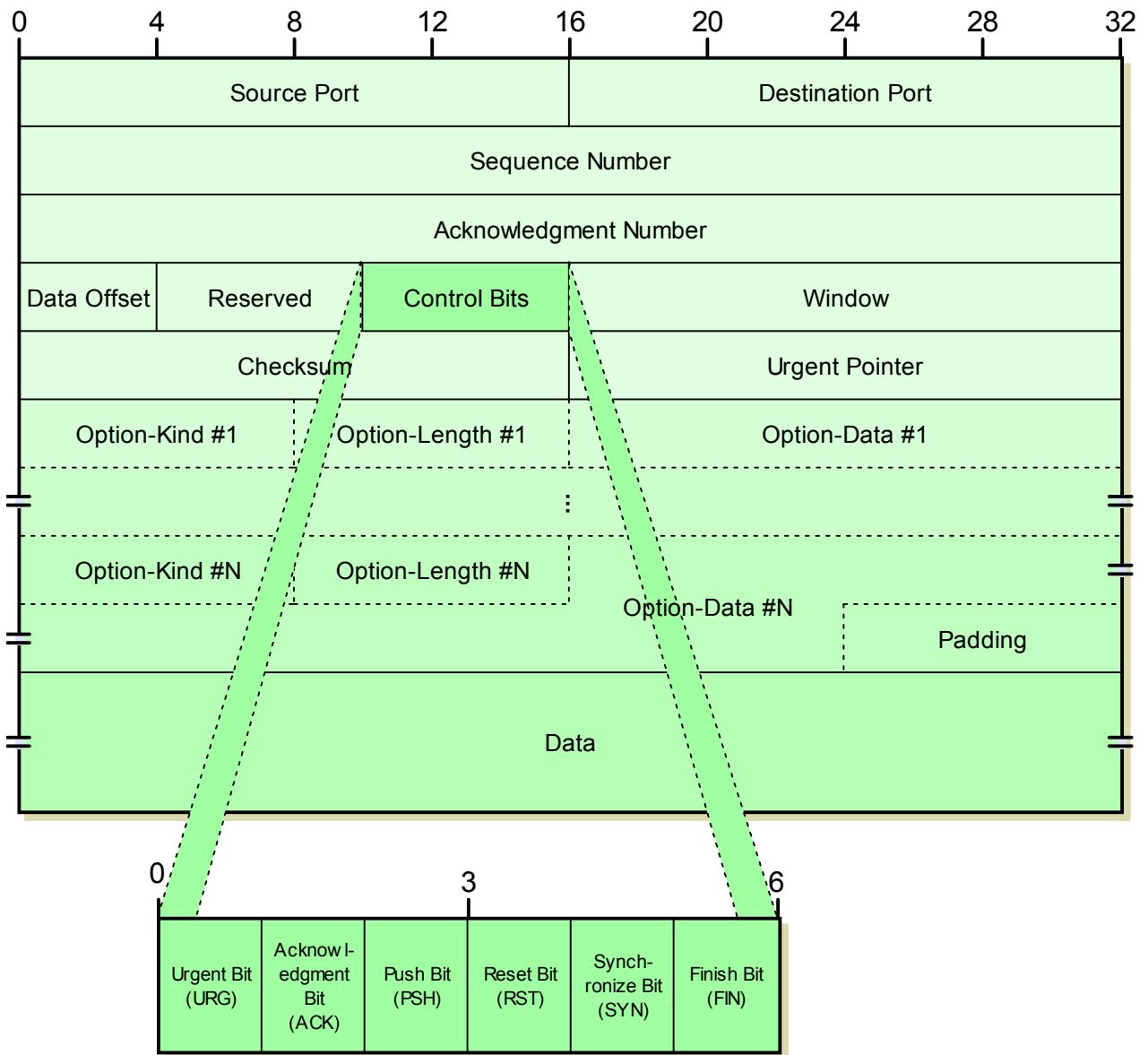

Figure 216: TCP Segment Format

TCP Options and Option Field Values

Table 158 shows the main options currently defined for TCP.

Table 158: TCP Options

Option-Kind	Option-Length	Option-Data	Description
0	—	—	End Of Option List: A single byte option that marks the end of all options included in this segment. This only needs to be included when the end of the options doesn't coincide with the end of the TCP header.
1	—	—	No-Operation: A “spacer” that can be included between options to align a subsequent option on a 32-bit boundary if needed.
2	4	Maximum Segment Size Value	Maximum Segment Size: Conveys the size of the largest segment the sender of the segment wishes to receive. Used only in connection request (SYN) messages.
3	3	Window Size Shift Bits	Window Scale: Implements the optional window scale feature, which allows devices to specify much larger window sizes than would be possible with the normal <i>Window</i> field. The value in <i>Option-Data</i> specifies the power of two that the <i>Window</i> field should be multiplied by to get the true window size the sender of the option is using. For example, if the value of <i>Option-Data</i> is 3, this means values in the <i>Window</i> field should be multiplied by 8, assuming both devices agree to use this feature. This allows very large windows to be advertised when needed on high-performance links. See the topic on data transfer for more.
4	2	—	Selective Acknowledgment Permitted: Specifies that this device supports the selective acknowledgment (SACK) feature . This was implemented as a two-byte option with no <i>Option-Data</i> field, instead of a single-byte option like <i>End Of Option List</i> or <i>No-Operation</i> . This was necessary because it was defined after the original TCP specification, so an explicit option length had to be indicated for backwards compatibility.
5	Variable	Blocks Of Data Selectively Acknowledged	Selective Acknowledgment: Allows devices supporting the optional selective acknowledgment feature to specify non-contiguous blocks of data that have been received so they are not retransmitted if intervening segments do not show up and need to be retransmitted.
14	3	Alternate Checksum Algorithm	Alternate Checksum Request: Lets a device request that a checksum generation algorithm other than the standard TCP algorithm be used for this connection. Both devices must agree to the algorithm for it to be used.
15	Variable	Alternate Checksum	Alternate Checksum: If the checksum value needed to implement an alternate checksum is too large to fit in the standard 16-bit Checksum field, it is placed in this option.

I have not shown every TCP option in Table 158, just the basic ones defined in RFC 793 and a few others that are interesting and correspond to features described elsewhere in the Guide. Note that most options are sent only in connection request (SYN) segments. This

includes the *Maximum Segment Size*, *Window Scale*, *Selective Acknowledgement Permitted* and *Alternate Checksum Request* options above. In contrast, *Selective Acknowledgement* and *Alternate Checksum* options appear in regular data segments, when used.

TCP Checksum Calculation and the TCP "Pseudo Header"

The Transmission Control Protocol is designed to provide reliable data transfer between a pair of devices on an IP internetwork. Much of the effort required to ensure reliable delivery of data segments is of necessity focused on the problem of ensuring that data is not lost in transit. But there's another important critical impediment to the safe transmission of data: the risk of *errors* being introduced into a TCP segment during its travel across the internetwork.

Detecting Transmission Errors Using Checksums

If the data gets where it needs to go but is corrupted and we do not detect the corruption, this is in some ways worse than it never showing up at all. To provide basic protection against errors in transmission, TCP includes a 16-bit *Checksum* field in its header. The idea behind a checksum is very straight-forward: take a string of data bytes and add them all together. Then send this sum with the data stream and have the receiver check the sum. In TCP, a special algorithm is used to calculate this checksum by the device sending the segment; the same algorithm is then employed by the recipient to check the data it received and ensure that there were no errors.

The checksum calculation used by TCP is a bit different than a regular checksum algorithm. A conventional checksum is performed over all the bytes that the checksum is intended to protect, and can detect most bit errors in any of those fields. The designers of TCP wanted this bit error protection, but also desired to protect against other type of problems.

Increasing The Scope of Detected Errors: the TCP Pseudo Header

To this end, a change was made in how the TCP checksum is computed. This special TCP checksum algorithm was eventually also [adopted for use by the User Datagram Protocol \(UDP\)](#).

Instead of computing the checksum over only the actual data fields of the TCP segment, a 12-byte TCP *pseudo header* is created prior to checksum calculation. This header contains important information taken from fields in both the TCP header and the IP datagram into which the TCP segment will be encapsulated. The TCP pseudo header has the format shown in Table 159 and Figure 217.

Table 159: TCP “Pseudo Header” For Checksum Calculation

Field Name	Size (bytes)	Description
Source Address	4	Source Address: The 32-bit IP address of the originator of the datagram, taken from the IP header.
Destination Address	4	Destination Address: The 32-bit IP address of the intended recipient of the datagram, also from the IP header.
Reserved	1	Reserved: 8 bits of zeroes.
Protocol	1	Protocol: The <i>Protocol</i> field from the IP header. This indicates what higher-layer protocol is carried in the IP datagram. Of course, we already know what this protocol is, it's TCP! So, this field will normally have the value 6.
TCP Length	2	TCP Length: The length of the TCP segment, including both header and data. Note that this is not a specific field in the TCP header; it is computed.

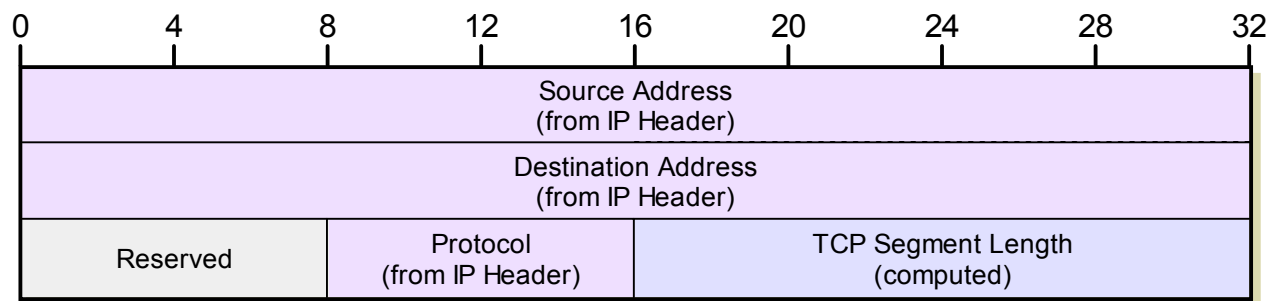
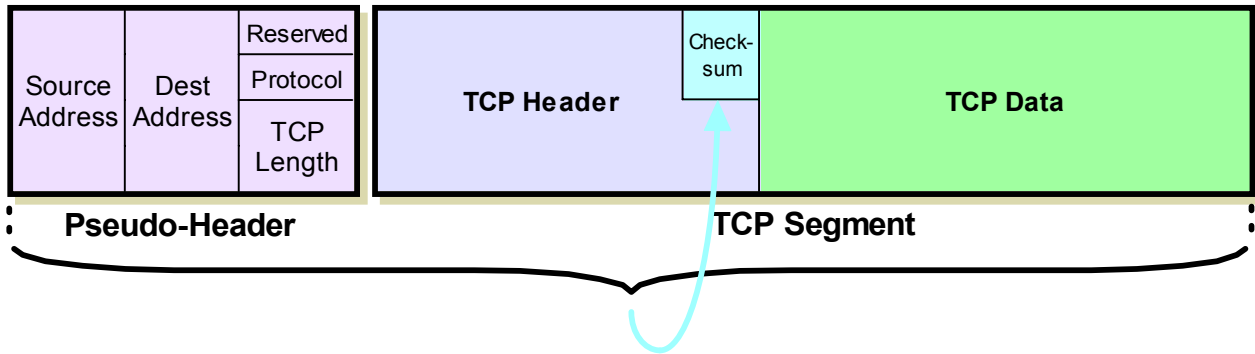

Figure 217: TCP “Pseudo Header” For Checksum Calculation

Once this 96-bit header has been formed, it is placed in a buffer, following which the TCP segment itself is placed. Then, the checksum is computed over the entire set of data (pseudo header plus TCP segment). The value of the checksum is placed into the *Checksum* field of the TCP header, and the pseudo header is discarded—it is **not** an actual part of the TCP segment and is not transmitted. This process is illustrated in Figure 218.



Note: The *Checksum* field is itself part of the TCP header and thus one of the fields over which the checksum is calculated, creating a “chicken and egg” situation of sorts. This field is assumed to be all zeroes during calculation of the checksum.



Checksum Calculated Over Pseudo Header and TCP Segment

Figure 218: TCP Header Checksum Calculation

To calculate the TCP segment header's *Checksum* field, the TCP pseudo header is first constructed and placed, logically, before the TCP segment. The checksum is then calculated over both the pseudo header and the TCP segment. The pseudo header is then discarded.

When the TCP segment arrives at its destination, the receiving TCP software performs the same calculation. It forms the pseudo header, prepends it to the actual TCP segment, and then performs the checksum (setting the *Checksum* field to zero for the calculation as before). If there is a mismatch between its calculation and the value the source device put in the *Checksum* field, this indicates that an error of some sort occurred and the segment is normally discarded.

Advantages of the Pseudo Header Method

So, why bother with this “pseudo header”? The source and destination devices both compute the checksum using the fields in this pseudo header. This means that if, for any reason, the two devices don't use the same values for the pseudo header, the checksum will fail. Now, when we consider what's in the header, we find that this means the checksum now protects against not just errors in the TCP segment fields but also against:

- ❶ **Incorrect Segment Delivery:** If there is a mismatch in the *Destination Address* between what the source specified and what the destination that got the segment used, the checksum will fail. The same will happen if the *Source Address* does not match.
- ❷ **Incorrect Protocol:** If a datagram is routed to TCP that actually belongs to a different protocol for whatever reason, this can be immediately detected.
- ❸ **Incorrect Segment Length:** If part of the TCP segment has been omitted by accident, the lengths the source and destination used won't match and the checksum will fail.

What's clever about the pseudo header is that by using it for the checksum calculation, we can provide this protection without actually needing to send the fields in the pseudo header itself. This eliminates duplicating the IP fields used in the pseudo header within the TCP header, which would be redundant and wasteful of bandwidth. The drawback of the pseudo header method is that it makes checksum calculation take more time and effort (though this is not much of an issue today.)

In the context of today's modern, high-speed, highly-reliable networks, the use of the pseudo header sometimes seems “archaic”. How likely is it that a datagram will be delivered to the wrong address? Not very. At the time TCP was created, however, there was significant concern that there might not be proper “end-to-end” checking of the delivery of datagrams at the IP level. Including IP information in the TCP checksum was seen as a useful additional level of protection.

Of course, there is one interesting implication of the TCP pseudo header: it violates the architectural layering principles that the designers of TCP sought to respect in splitting TCP and IP up. For the checksum, TCP must know IP information that technically it “shouldn't”. TCP checksum calculation requires, for example, that the protocol number from the IP header be given to the TCP layer on the receiving device from the IP datagram that carried the segment. The TCP pseudo header is a good example of a case where strict layering was eschewed in favor of practicality.

Finally, TCP also supports an optional method of having two devices agree on an alternative checksum algorithm. This must be negotiated during connection establishment.



Key Concept: TCP checksums are computed over not just the TCP segment but also over a TCP *pseudo header* that contains the length of the TCP segment as well as the IP *Source Address*, *Destination Address* and *Protocol* fields. Since these fields are part of the checksum, if the segment is received by the wrong device, or has the incorrect *Protocol* field or segment length, it will be rejected. The technique is clever because the checksum can provide this protection even though the pseudo header itself is not actually transmitted.

TCP Maximum Segment Size (MSS) and Relationship to IP Datagram Size

TCP *segments* are the messages that carry data between TCP devices. The *Data* field is where the actual data being transmitted is carried, and since the length of the *Data* field in TCP is variable, this raises an interesting question: how much data should we put into each segment? With protocols that accept data in blocks from the higher layers there isn't as much of a question, but TCP accepts data as a constant stream from the applications that use it. This means it must decide how many bytes to put into each message that it sends.

A primary determinant of how much data to send in a segment is the current status of the [sliding window mechanism](#) on the part of the receiver. When Device *A* receives a TCP segment from Device *B*, it examines value of the *Window* field to know the limit on how much data Device *B* is allowing Device *A* to send in its next segment. There are also important issues in the selection and adjustment of window size that impact the operation of the TCP system as a whole, which are discussed in [the reliability section](#).

In addition to the dictates of the current window size, each TCP device also has associated with it a *ceiling* on TCP size—a segment size that will never be exceeded regardless of how large the current window is. This is called the *maximum segment size (MSS)*. When

deciding how much data to put into a segment, each device in the TCP connection will choose the amount based on the current window size, in conjunction with the various algorithms described in the reliability section, but it will never be so large that the amount of data exceeds the MSS of the device to which it is sending.



Note: I need to point out that the name “maximum segment size” is in fact misleading. The value actually refers to the maximum amount of **data** that a segment can hold—it does not include the TCP headers. So if the MSS is 100, the actual maximum segment size could be 120 (for a regular TCP header) or larger (if the segment includes TCP options).

Maximum Segment Size Selection

The selection of the MSS is based on the need to balance various competing performance and implementation issues in the transmission of data on TCP/IP networks. The main TCP standard, RFC 793, doesn't discuss MSS very much, which opened the potential for confusion on how the parameter should be used. RFC 879 was published a couple of years after the TCP standard to clarify this parameter and the issues surrounding it. Some issues with MSS are fairly mundane; for example, certain devices are limited in the amount of space they have for buffers to hold TCP segments, and therefore may wish to limit segment size to a relatively small value. In general, though, the MSS must be chosen by balancing two competing performance issues:

- ☉ **Overhead Management:** The TCP header takes up 20 bytes of data (or more if options are used); the IP header also uses 20 or more bytes. This means that between them a minimum of 40 bytes are needed for headers, all of which is non-data “overhead”. If we set the MSS too low, this results in very inefficient use of bandwidth. For example, suppose we set it to 40; if we did, a **maximum** of 50% of each segment could actually be data; the rest would just be headers. Many segment datagrams would be even worse in terms of efficiency.
- ☉ **IP Fragmentation:** TCP segments will be packaged into IP datagrams. As we saw in the section on IP, datagrams have their own size limit issues: the matter of [the maximum transmission unit \(MTU\) of an underlying network](#). If a TCP segment is too large, it will lead to an IP datagram is too large to be sent without fragmentation. Fragmentation reduces efficiency and increases the chances of part of a TCP segment being lost, resulting in the entire segment needing to be retransmitted.

TCP Default Maximum Segment Size

The solution to these two competing issues was to establish a default MSS for TCP that was as large as possible while avoiding fragmentation for most transmitted segments. This was computed by starting with the minimum MTU for IP networks of 576. All networks are required to be able to handle an IP datagram of this size without fragmenting. From this number, we subtract 20 bytes for the TCP header and 20 for the IP header, leaving 536 bytes. This is the standard MSS for TCP.

The selection of this value was a compromise of sorts. When this number is used, it means that **most** TCP segments will be sent unfragmented across an IP internetwork. However, if any TCP or IP options are used, this will cause the minimum MTU of 576 to be exceeded and fragmentation to happen. Still, it makes more sense to allow some segments to be fragmented rather than use a much smaller MSS to ensure that none are ever fragmented. If we chose, say, an MSS of 400, we would probably never have fragmentation, but we'd lower the data/header ratio from 536:40 (93% data) to 400:40 (91% data) for **all** segments.



Key Concept: TCP is designed to restrict the size of the segments it sends to a certain maximum limit, to cut down on the likelihood that segments will need to be fragmented for transmission at the IP level. The TCP *maximum segment size (MSS)* specifies the maximum number of bytes in the TCP segment's *Data* field, regardless of any other factors that influence segment size. The default MSS for TCP is 536, which results from taking the minimum IP MTU of 576 and subtracting 20 bytes each for the IP and TCP headers.

Specifying a Non-Default MSS Value

Naturally, there are likely to be cases where the default MSS is non-ideal, so TCP provides a means for a device to specify that the MSS it wants to use is either smaller or larger than the default value of 536. [A device can inform the other of the MSS it wants to use](#) during the connection establishment process. A device that chooses to do so includes in its SYN message the TCP option called, appropriately, *Maximum Segment Size*. The other device receives this option and records the MSS for the connection. Each device can specify the MSS it wants for the segments it receives independently.



Note: The exchange of MSS values during setup is sometimes called *MSS negotiation*. This is actually a misleading term, because it implies that the two devices must agree on a common MSS value, which is not the case. The MSS value used by each may be different, and there is in fact no negotiation at all.

Devices may wish to use a larger MSS if they know for a fact that the MTUs of the networks the segments will pass over are larger than the IP minimum of 576. This is most commonly the case when large amounts of data are sent on a local network; the process of [path MTU discovery](#) is used to determine the appropriate MSS. A smaller MSS might be advisable if it were known that a particular optional feature was in place that would consistently increase the size of the IP header. Employing [IPSec](#) for security would be a good example.



Key Concept: Devices can indicate that they wish to use a different MSS value from the default by including a `©Maximum Segment Size` option in the SYN message they use to establish a connection. Each device in the connection may use a different MSS value.

TCP Sliding Window Data Transfer and Acknowledgement Mechanics

The [TCP connection establishment process](#) is employed by a pair of devices to create a TCP connection between them. Once all the setup is done, [transmission control blocks \(TCBs\) set up, parameters have been exchanged](#) and so forth, the devices are ready to get down to business: transferring data.

The sending of data between TCP devices on a connection is accomplished using [the sliding window system we explored in the fundamentals section](#). It's now time to take a more detailed look at exactly how sliding windows are implemented to allow data to be sent and received. For ease of explanation, we'll assume that our connection is between a client and a server—this is easier than the whole “Device A / Device B” thing.

Sliding Window Transmit Categories

Each of the two devices on a connection must keep track of the data it is sending, as well as the data it is receiving from the other device. This is done by conceptually dividing the bytes into the *categories* we saw in the sliding windows overview. For data being transmitted, there are four transmit categories:

1. **Transmit Category #1:** Bytes Sent And Acknowledged
2. **Transmit Category #2:** Bytes Sent But Not Yet Acknowledged
3. **Transmit Category #3:** Bytes Not Yet Sent For Which Recipient Is Ready
4. **Transmit Category #4:** Bytes Not Yet Sent For Which Recipient Is Not Ready

Sliding Window Receive Categories

For data being received, there is no need to separate into “received and acknowledged” and “received and unacknowledged” the way the transmitter separates its first two categories into “sent and acknowledged” and “sent but not yet acknowledged. The reason, of course, is that the transmitter must wait for acknowledgment of each transmission, while the receiver doesn't need “acknowledgment” that it received something.

Thus, one receive category corresponds to Transmit Categories #1 and #2, while the other two correspond to Transmit Category #3 and Transmit Category #4 respectively, making three receive categories overall. To help make more clear how the categories relate, I am numbering them as follows:

- ☉ **Receive Category #1+2:** Bytes Received And Acknowledged. This is the receiver's complement to Transmit Categories #1 and #2.

-
- ⦿ **Receive Category #3:** Bytes Not Yet Received For Which Recipient Is Ready. This is the receiver's complement to Transmit Category #3.
 - ⦿ **Receive Category #4:** Bytes Not Yet Received For Which Recipient Is Not Ready. This is the receiver's complement to Transmit Category #4.

Send (SND) Pointers

Both the client and server in the connection must keep track of the stream it is transmitting and the one it is receiving from the other device. This is done using a set of special variables called *pointers*, that carve the byte stream into the categories above. The four transmit categories are divided using three pointers. Two of the pointers are absolute (refer to a specific sequence number) while one is an offset that is added to one of the absolute pointers, as follows (refer to [Figure 219](#)):

- ⦿ **Send Unacknowledged (SND.UNA):** The sequence number of the first byte of data that has been sent but not yet acknowledged. This marks the first byte of Transmit Category #2; all previous sequence numbers refer to bytes in Transmit Category #1.
- ⦿ **Send Next (SND.NXT):** The sequence number of the next byte of data to be sent to the other device (the server in this case). This marks the first byte of Transmit Category #3.
- ⦿ **Send Window (SND.WND):** The size of the send window. Recall that the window specifies the total number of bytes that any device may have "outstanding" (*unacknowledged*) at any one time. Thus, adding the sequence number of the first unacknowledged byte (*SND.UNA*) and the send window (*SND.WND*) marks the first byte of Transmit Category #4.

Another way of looking at these pointers is how they indicate the number of bytes a transmitting device can send at any point in time; that is, the number of bytes in Transmit Category #3. The start of Transmit Category #3 is marked by *SND.NXT*. The end is marked by the first byte of Transmit Category #4, given by *SND.UNA+SND.WND*. Thus, the number of bytes in Transmit Category #3 is given by the following formula:

$$SND.UNA + SND.WND - SND.NXT$$

This is called the *usable window*, since it indicates how many bytes the transmitter can use at any point in time. When data is acknowledged, this causes bytes to move from Transmit Category #2 to Category #1, by increasing the value of *SND.UNA*. Assuming that the send window size doesn't change, this causes the window to *slide* to the right, permitting more data to be sent.

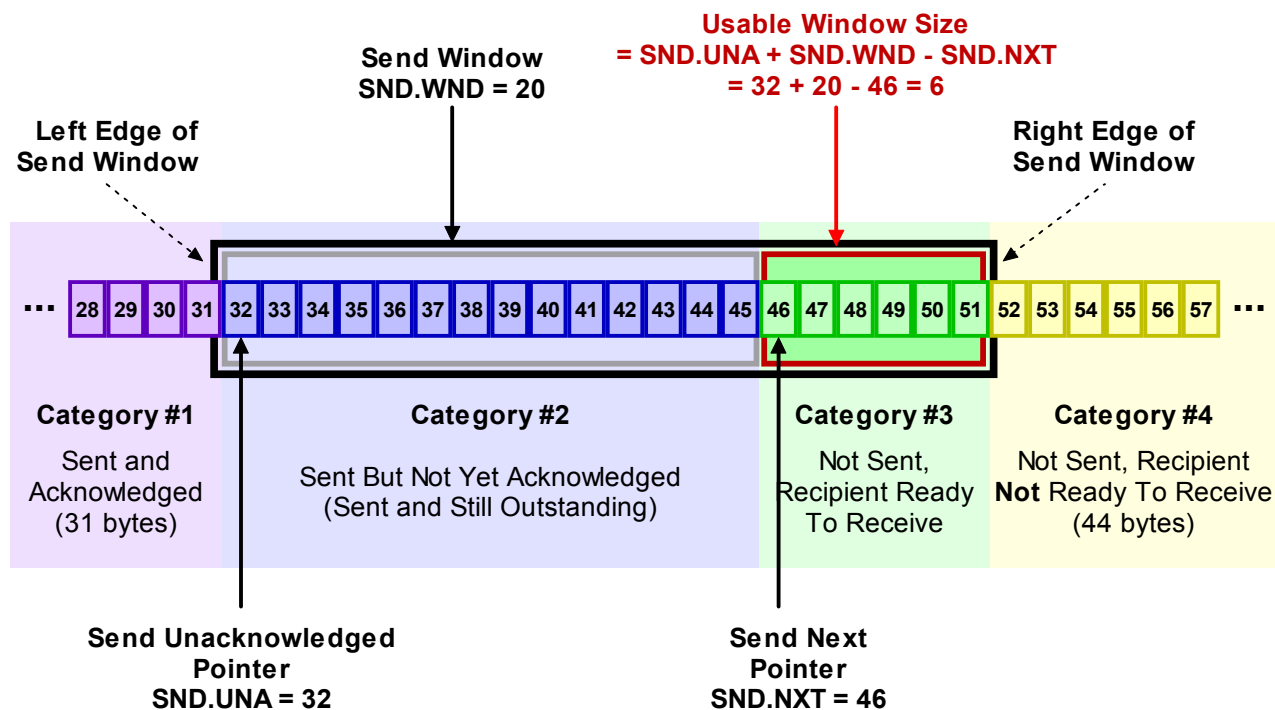

Figure 219: TCP Transmission Categories, Send Window and Pointers

This diagram is the same as Figure 207, but shows the TCP send pointers. *SND.UNA* points to the start of Transmit Category #2, *SND.NXT* points to the start of Transmit Category #3, and *SND.WND* is the size of the send window. The size of the usable window can be calculated as shown from those three pointers.



Key Concept: The TCP sliding windows scheme uses three pointers that keep track of which bytes are in each of the four transmit categories. *SND.UNA* points to the first unacknowledged byte and indicates the start of Transmit Category #2; *SND.NXT* points to the next byte of data to be sent and marks the start of Transmit Category #3. *SND.WND* contains the size of the send window; it is added to *SND.NXT* to mark the start of Transmit Category #4. Adding *SND.WND* to *SND.UNA* and then subtracting *SND.NXT* yields the current size of the usable transmit window.

Receive (RCV) Pointers

The three receive categories are divided using two pointers:

- ☉ **Receive Next (RCV.NXT):** The sequence number of the next byte of data that is expected from the other device. This marks the first byte in Receive Category #3. All previous sequence numbers refer to bytes already received and acknowledged, in Receive Category #1+2.

- Receive Window (*RCV.WND*):** The size of the receive window “advertised” to the other device. This refers to the number of bytes the device is willing to accept at one time from its peer, which is usually the size of the buffer allocated for receiving data for this connection. When added to the *RCV.NXT* pointer, marks the first byte of Receive Category #4.

The receive categories and pointers are illustrated in [Figure 220](#).

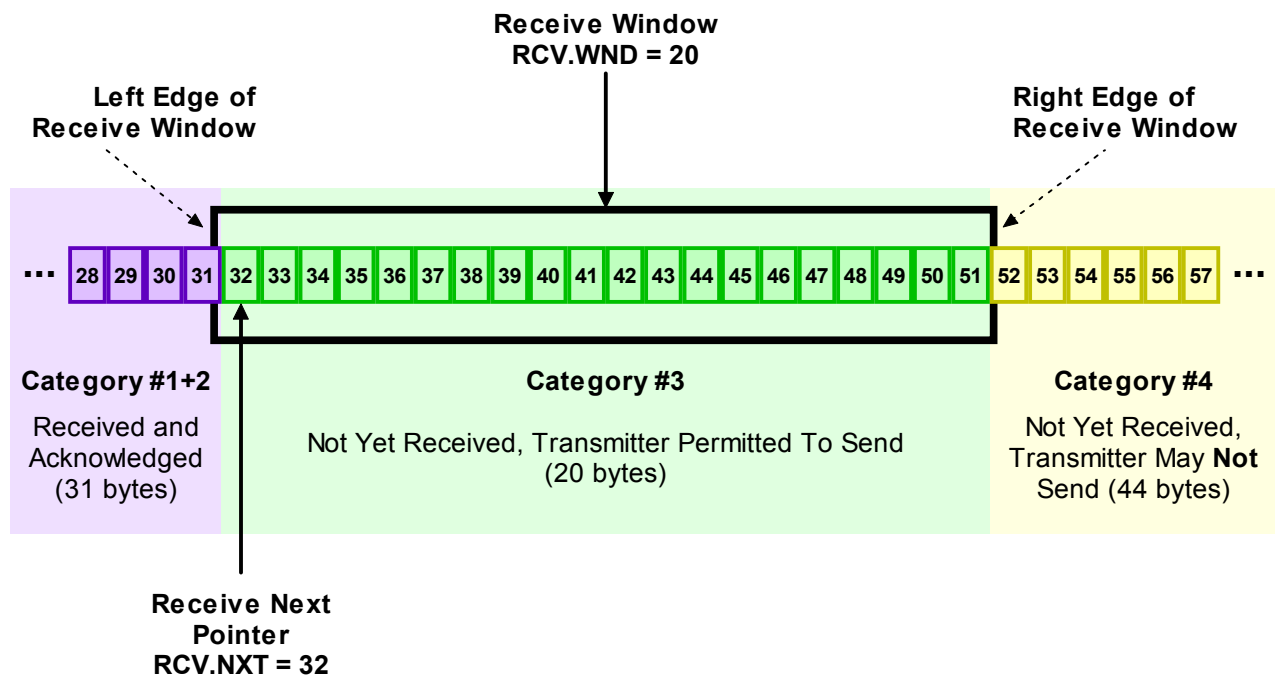

Figure 220: TCP Receive Categories and Pointers

This diagram is the complement of [Figure 219](#), showing how the categories are set up for the receiving device. Categories #1 and #2 have been combined since there is no differentiation between “received and unacknowledged” and “received and acknowledged”. This example shows the state of the receiving device prior to receipt of the 14 bytes that in [Figure 219](#) have already been sent.



Key Concept: A set of receive pointers are maintained by each device, which are the complement of the send pointers. A device’s send pointers keep track of its outgoing data and its receive pointers the incoming data. The two receive pointers are *RCV.NXT*, which indicates the number of the next byte of data expected from the other device, and *RCV.WND*, which is the size of the receive window for that device. The *RCV.WND* of one device equals the *SND.WND* of the other device on the connection.

The Relationship Between Send and Receive Pointers

The *SND* and *RCV* pointers are complementary, of course, just as the categories are, with each device managing both the sending of its data and receiving of data from its peer. Assuming we have a client and a server, then:

- ☉ **Client:** The *SND* pointers keep track of the client's outgoing data stream; the *RCV* pointers refer to the data coming in from the server. The client's *SND* categories correspond to the server's *RCV* categories.
- ☉ **Server:** The *SND* pointers keep track of the server's outgoing data stream; the *RCV* pointers refer to the data being received from the client. The server's *SND* categories correspond to the client's *RCV* categories.

TCP Segment Fields Used to Exchange Pointer Information

Since the *SND* and *RCV* values are complementary, the send window of one device is the receive window of the other, and vice-versa. Note, however, that the values of the pointers do not always line up exactly between the two devices, because at any given time, some bytes may be in transit between the two. [Figure 220](#), for example, shows the receive pointers of the recipient *prior* to receiving bytes 32 to 45, which are shown in transit in [Figure 219](#).

Both *SND* and *RCV* pointers are all maintained in the transmission control block (TCB) for the connection held by each device. As data is exchanged the pointers are updated, and communication about the state of the send and receive streams is exchanged using control fields in the TCP segment format. The three most important ones are:

- ☉ **Sequence Number:** Identifies the sequence number of the first byte of data in the segment being transmitted. This will normally be equal to the value of the *SND.UNA* pointer at the time that data is sent.
- ☉ **Acknowledgment Number:** Acknowledges the receipt of data by specifying the sequence number that the sender of the segment expects in the segment recipient's next transmission. This field will normally be equal to the *RCV.NXT* pointer of the device that sends it.
- ☉ **Window:** The size of the receive window of the device sending the segment (and thus, the send window of the device receiving the segment.)

The *Acknowledgment Number* field is critical because this is what a device uses to tell its peer what segments it has received. The system is **cumulative**: the *Acknowledgment Number* field says "I have received all data bytes with sequence numbers less than this value". This means if a client receives many segments of data from a server in rapid succession, it can acknowledge all of them using a single number, as long as they are contiguous. If they are not contiguous, then [things get more complicated](#).



Key Concept: Three essential fields in the TCP segment format are used to implement the sliding windows system. The *Sequence Number* field indicates the number of the first byte of data being transmitted. The *Acknowledgment Number* is used to acknowledge data received by the device sending this segment. The *Window* field tells the recipient of the segment the size to which it should set its send window.

Example Illustration of TCP Sliding Window Mechanics

To see how all of this works, let's consider the example of a client and server using a mythical file retrieval protocol. This protocol specifies that the client sends a request and receives an immediate response from the server. The server then sends the file requested when it is ready.

The two devices will of course first establish a connection and [synchronize sequence numbers](#). For simplicity, let's say the client uses an initial sequence number (ISN) of 0, and the server an ISN of 240. The server will send the client an *ACK* with an *Acknowledgment Number* of 1, indicating it is the sequence number it expects to receive next. Let's say the server's receive window size is set to 350, so this is the client's send window size. The client will send its *ACK* with an *Acknowledgment Number* of 241. Let's say its receive window size is 200 (and the server's client window size is thus 200). Let's assume that both devices maintain the same window size throughout the transaction. This won't normally happen, especially if the devices are busy, but the example is complicated enough. Let's also say the [maximum segment size](#) is 536 bytes in both directions. This means that the MSS won't affect the size of actual segments in this example (since the MSS is larger than the send window sizes for both devices.)

With the background for our example established, we can now follow a sample transaction to show in detail how the send and receive pointers are created and changed as messages are exchanged between client and server. [Table 160](#) describes the process in detail, showing for each step what the send and receive pointers are for both devices. It is rather large, so beware. ☺ The transaction is also graphically illustrated in two figures: [Figure 221](#) and [Figure 222](#). Both illustrate the same exchange of messages, using the step numbers of [Table 160](#), but each from the perspective of one of the devices. [Figure 221](#) shows the

server's send pointers and client's receive pointers; [Figure 222](#) shows the client's send pointers and server's receive pointers. (I would have put them all in one diagram but it wouldn't fit!)

Table 160: TCP Transaction Example With Send and Receive Pointers (Page 1 of 3)

Client						Server					
Process Step	SND. UNA	SND. NXT	SND. WND	RCV. NXT	RCV. WND	Process Step	SND. UNA	SND. NXT	SND. WND	RCV. NXT	RCV. WND
Description						Description					
(setup)	1	1	360	241	200	(setup)	241	241	200	1	360
During connection establishment, the client sets up its pointers based on the parameters exchanged during setup. Notice that the <i>SND.UNA</i> and <i>SND.NXT</i> values are the same — no data has been sent yet so nothing is unacknowledged. <i>RCV.NXT</i> is the value of the first byte of data expected from the server.						The server sets up its pointers just as the client does. Notice how its values are the complement of the client's.					
1. Send Request	1	141	360	241	200	(wait)	241	241	200	1	360
The client transmits a request to the server. Let's say the request is 140 bytes in length. It will form a segment with a data field of this length and transmit it with the <i>Sequence Number</i> set to 1, the sequence number of the first byte. Once this data has been sent, the client's <i>SND.NXT</i> pointer will be incremented to the value 141 to indicate this is the next data to be sent to the server.						The server does nothing, waiting for a request.					
(wait)	1	141	360	241	200	2. Receive Request, Send Ack & Reply	241	321	200	141	360
At this point the client hasn't received an acknowledgment for its request. At present, <i>SND.UNA+SND.WND</i> is 361, while <i>SND.NXT</i> is 141. This means the current usable window is 220 bytes. The the client could send up to 220 more bytes of data before getting back an acknowledgment. For now, let's say it has nothing more to transmit.						The server receives the 140-byte request from the client. The server sends back an 80-byte response that also acknowledges the client's TCP segment. The <i>Sequence Number</i> field will be 241, the first sequence number of the server's 80 bytes of data. The <i>Acknowledgment Number</i> will be 141, telling the client that is the next sequence number the server expects to hear, and thereby implicitly acknowledging receipt of bytes 1 through 140. The server increases its <i>RCV.NXT</i> pointer to 141 to reflect the 140 bytes of data received. It increases its <i>SND.NXT</i> pointer by 80.					

Table 160: TCP Transaction Example With Send and Receive Pointers (Page 2 of 3)

Client						Server					
Process Step	SND. UNA	SND. NXT	SND. WND	RCV. NXT	RCV. WND	Process Step	SND. UNA	SND. NXT	SND. WND	RCV. NXT	RCV. WND
Description						Description					
3. Receive Ack & Reply, Send Ack	141	141	360	321	200	4. Send Part 1 of File	241	441	200	141	360
<p>The client receives the server's response. It sees the Acknowledgment Number of 141 and knows bytes 1 to 140 were successfully received. It increases its <i>SND.UNA</i> to 141, effectively "sliding the send window" by 140.</p> <p>The client also accepts the 80 bytes of data the server sent, increasing its <i>RCV.NXT</i> pointer by 80. Assuming it has no more data to send, it sends back a TCP segment that is a pure acknowledgment of the server's response. This segment has no data, and an <i>Acknowledgment Number</i> value of 321.</p>						<p>While the client was receiving its response, the server's TCP was supplied with a 280 byte file to be sent to the client. It cannot send this all in one segment however. The current value of <i>SND.UNA+SND.WND</i> is 441, while <i>SND.NXT</i> is 321. Thus, the server's usable window contains 120 bytes of data. It creates a TCP segment with this much data and a <i>Sequence Number</i> of 321. It increases the <i>SND.NXT</i> pointer to 441. The server has now filled the send window.</p> <p>Note that the server does not have to wait for an acknowledgement to the reply it sent in step #2. This is a key factor in TCP's ability to ensure high throughput.</p>					
5. Receive Part 1 of File, Send Ack	141	141	360	441	200	6. Receive Ack for Reply	321	441	200	141	360
<p>The client receives the first 120-byte part of the file the server was sending. It increases the <i>RCV.NXT</i> pointer to 441 and sends an acknowledgment back with an <i>Acknowledgment Number</i> of 441. Again, if it had another request to make of the server it could include it here, but we'll assume it does not.</p>						<p>The server receives the client's acknowledgment of its earlier 80-byte response (sent in step #2). It increases its <i>SND.UNA</i> to 321. Since it just received acknowledgment of 80 bytes (and the client's window didn't change), the server's usable window is now 80 bytes. However, as we will see in the section on TCP performance, sending small segments like this can lead to performance issues. Let's say the server has been programmed to not send segments under 100 bytes when it has a lot of data to transmit. It decides to wait.</p>					
(wait)	141	141	360	441	200	7. Receive Ack for Part 1 of File	441	441	200	141	360
<p>The client waits for the rest of the file.</p>						<p>The server receives the acknowledgment for the first part of the file. It increases <i>SND.UNA</i> to 441. This now restores the full 200 byte window.</p>					

Table 160: TCP Transaction Example With Send and Receive Pointers (Page 3 of 3)

Client						Server					
Process Step	SND. UNA	SND. NXT	SND. WND	RCV. NXT	RCV. WND	Process Step	SND. UNA	SND. NXT	SND. WND	RCV. NXT	RCV. WND
Description						Description					
(still waiting ☺)	141	141	360	441	200	8. Send Part 2 of File	441	601	200	141	360
The client continues to wait for the rest of the file.						The server sends the remaining 160 bytes of data in the file in one segment. It increases <i>SND.NXT</i> by 160, and sends the data with a <i>Sequence Number</i> value of 441.					
9. Receive Part 2 of File, Send Ack	141	141	360	601	200	(wait)	441	601	200	141	360
The client receives the rest of the file and acknowledges it. It increases <i>RCV.NXT</i> to 601 and sends back a segment with an <i>Acknowledgment Number</i> of 601.						The server is done for now; it waits for the acknowledgment of the second part of the file.					
(done)	141	141	360	601	200	10. Receive Ack for Part 2 of File	601	601	200	141	360
The client is done with this exchange.						The server receives the second acknowledgment and slides its send window forward by 160 bytes. The transaction is now completed.					

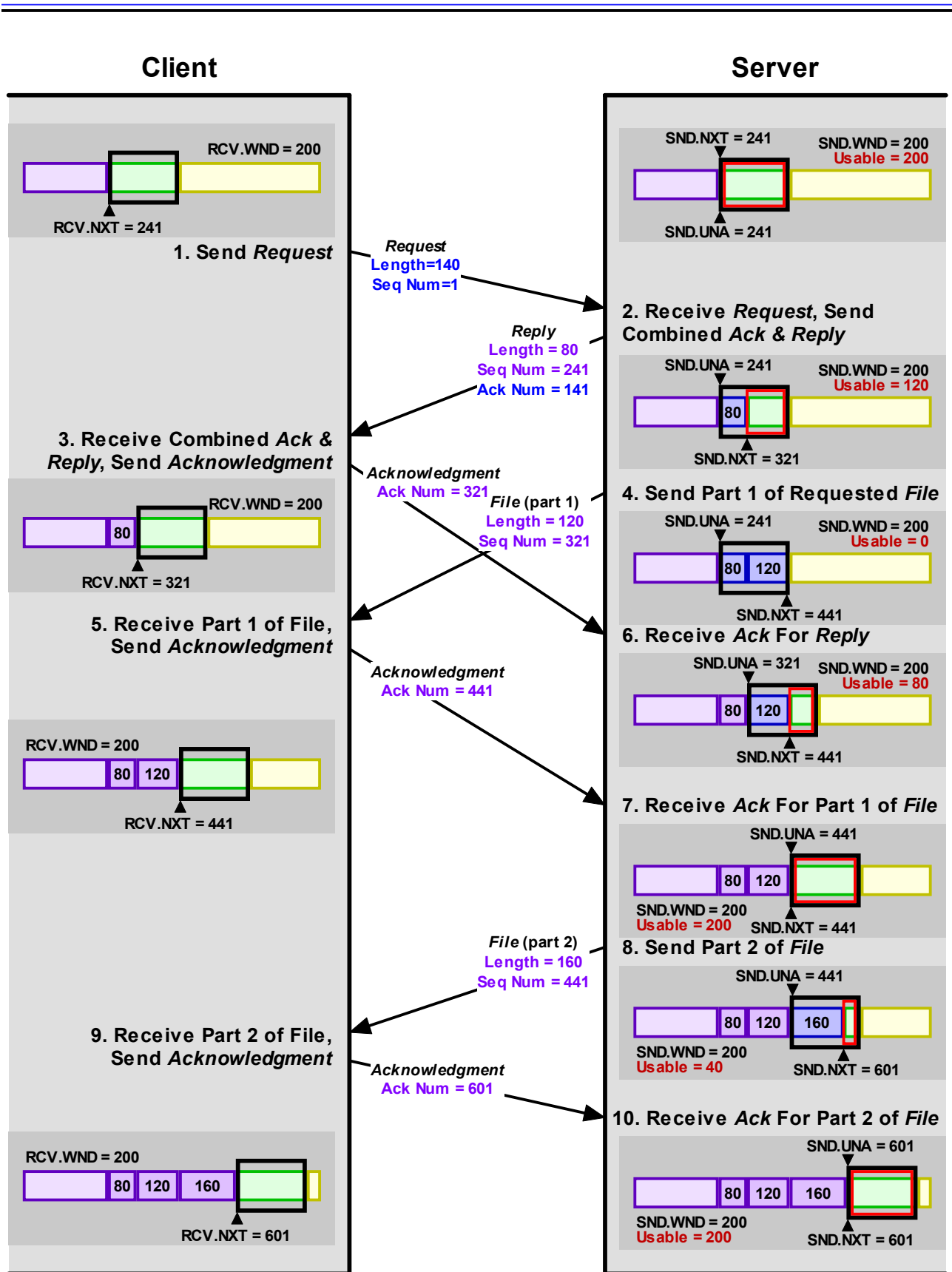

Figure 221: TCP Transaction Example Showing Server's Send Pointers
 The transaction of Table 160 from the perspective of the server. See Figure 222 for the client's pointers.

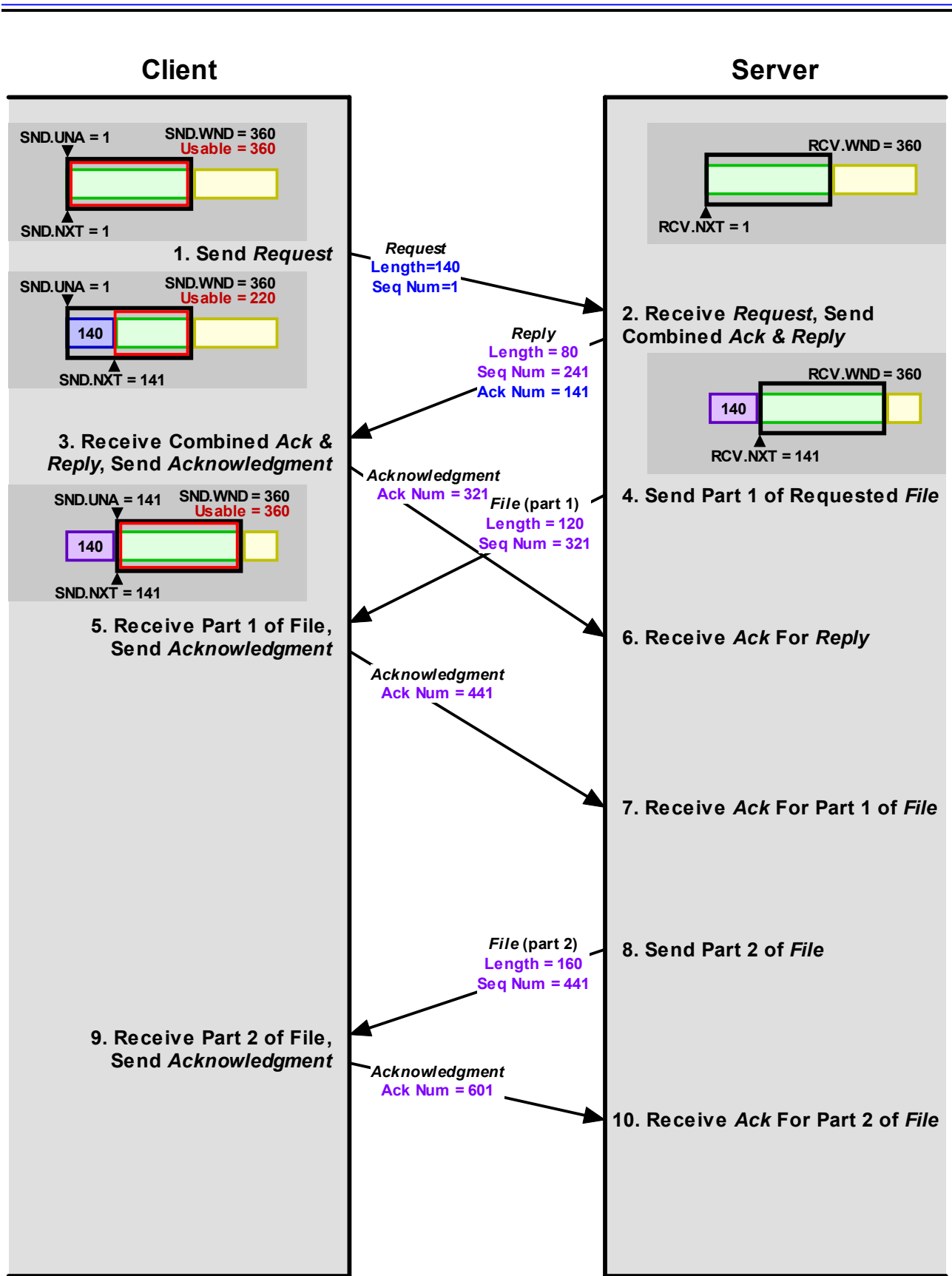

Figure 222: TCP Transaction Example Showing Client's Send Pointers

The transaction of [Table 160](#) from the perspective of the client. See [Figure 221](#) for the server's pointers.

Real-World Complications of the Sliding Window Mechanism

I'm sure this seems rather complicated, but in fact, the example is highly *simplified*, to show you how the basic data transfer mechanism works without too much going on. Scary, isn't it? ☺ A real world connection would include several complications:

- ☉ **Overlapping Transmissions:** I intentionally showed only one request from the client and the response from the server. In reality, the client and server could be pumping many requests and responses at each other in rapid-fire succession; the client would be acknowledging segments received from the server with segments that themselves contained new requests, and so on.
- ☉ **Acknowledgment of Multiple Segments:** I also didn't show a case where two segments are received by a device and acknowledged with a single acknowledgment, though this can certainly happen. Suppose that in the example above, the two parts of the 280-byte file were sent at once and received by the client at the same time. The client would acknowledge both by sending a single segment with an *Acknowledgment Number* of 601. Remember, this field is a *cumulative* acknowledgment of all segments containing data through the number preceding it, so this would acknowledge all data up to byte 600.
- ☉ **Fluctuating Window Sizes For Flow Control:** The window sizes in the example above remained constant, but in a real connection this will not always be the case. A very busy server may not be able to process and remove data from its buffer as fast as it acknowledges it. It may need to reduce its receive window to reduce the amount of data the client sends it, and then increase the window when more space becomes available. [This is how TCP implements flow control.](#)
- ☉ **Lost Transmissions:** In a real connection, some transmitted segments will be lost and need to be retransmitted. This is handled by [TCP's retransmission scheme](#).
- ☉ **Avoiding Small Window Problems:** I hinted in the table above that we don't necessarily always want to send data as fast as we can, when it means we have to send a very small segment. The reason is that this can lead to performance degradation, including a phenomenon called [silly window syndrome](#). This too will be explored in the section that follows, where we will see how handling it requires that we [change the simple sliding windows scheme](#) we have seen until the point.
- ☉ **Congestion Handling and Avoidance:** The basic sliding window mechanism has been changed over the years to avoid having TCP connections cause internetwork congestion and to have them handle congestion when it is detected. Congestion issues are discussed, you guessed it, [in the next section](#).

TCP Immediate Data Transfer: "Push" Function

The fact that TCP [takes incoming data from a process as an unstructured stream of bytes](#) gives it great flexibility in meeting the needs of most applications. There is no need for an application to create blocks or messages; it just sends the data to TCP when it is ready for transmission. For its part, TCP has no knowledge or interest in the meaning of the bytes of data in this stream. They are "just bytes" and TCP just sends them without any real concern for their structure or purpose.

This has a couple of interesting impacts on how applications work. One is that TCP does not provide any natural indication of the dividing point between pieces of data, such as database records or files. The application must take care of this. Another result of TCP's byte orientation is that TCP cannot decide when to form a segment and send bytes between devices based on the contents of the data. TCP will generally accumulate data sent to it by an application process in a buffer. It chooses when and how to send data based solely on [the sliding window system discussed in the previous topic](#), in combination with logic that helps to ensure efficient operation of the protocol.

This means that while an application can control the rate and timing with which it sends data to TCP, it cannot inherently control the timing with which TCP itself sends the data over the internetwork. Now, if we are sending a large file, for example, this isn't a big problem. As long as we keep sending data, TCP will keep forwarding it over the internetwork. It's generally fine in such a case to let TCP fill its internal transmit buffer with data and form a segment to be sent when TCP feels it is appropriate.

Problems with Accumulating Data for Transmission

However, there are situations where letting TCP accumulate data before transmitting it can cause serious application problems. The classic example of this is an interactive application such as the [Telnet Protocol](#). When you are using such a program, you want each keystroke to be sent immediately to the other application; you don't want TCP to accumulate hundreds of keystrokes and then send them all at once. The latter may be more “efficient” but it makes the application unusable, which is really putting the cart before the horse.

Even with a more mundane protocol that transfers files, there are many situations in which we need to say “send the data **now**”. For example, many protocols begin with a client sending a request to a server—like the hypothetical one in the example in the preceding topic, or a request for a Web page sent by a Web browser. In that circumstance, we want the client's request sent immediately; we don't want to wait until enough requests have been accumulated by TCP to fill an “optimal-sized” segment.

Forcing Immediate Data Transfer

Naturally, the designers of TCP realized that a way was needed to handle these situations. When an application has data that it needs to have sent across the internetwork immediately, it sends the data to TCP, and then uses the TCP *push* function. This tells the sending TCP to immediately “push” all the data it has to the recipient's TCP as soon as it is able to do so, without waiting for more data.

When this function is invoked, TCP will create a segment (or segments) that contains all the data it has outstanding, and will transmit it with the *PSH* control bit set to 1. The destination device's TCP software, seeing this bit set, will know that it should not just take the data in the segment it received and buffer it, but rather push it through directly to the application.

It's important to realize that the push function **only** forces immediate delivery of data. It does not change the fact that TCP provides no boundaries between data elements. It may **seem** that an application could send one record of data and then “push” it to the recipient;

then send the second record and “push” that, and so on. However, the application cannot assume that because it sets the *PSH* bit for each piece of data it gives to TCP, that each piece of data will be in a single segment. It possible that the first “push” may contain data given to TCP earlier that wasn't yet transmitted, and it's also possible that two records “pushed” in this manner may end up in the same segment anyway.



Key Concept: TCP includes a special “push” function to handle cases where data given to TCP needs to be sent immediately. An application can send data to its TCP software and indicate that it should be pushed. The segment will be sent right away rather than being buffered. The pushed segment's *PSH* control bit will be set to one to tell the receiving TCP that it should immediately pass the data up to the receiving application.

TCP Priority Data Transfer: "Urgent" Function

TCP treats data to be transmitted as just an unstructured stream of bytes, and this has some important implications on how it used. One aspect of this characteristic is that since TCP doesn't understand the content of the data it sends, it normally treats all the data bytes in a stream as *equals*. The data is sent to TCP in a particular sequence, and is transmitted in that same order. This makes TCP, in this regard, like those annoying voice mail systems that tell you not to hang up because they will answer calls in the order received.



Note: Pet peeve: I hate being told “your call will be answered in the order in which it was received”. I only made one call, so my call wasn't received in any “order”! The phrase should be in the plural: “calls will be answered in the order in which they were received”. ☺

TCP's Normal Data Processing: First In, First Out

Of course, while waiting on hold is irritating, this *first in, first out* behavior is usually how we **want** TCP to operate. If we are transmitting a message or a file we want to be able to give TCP the bytes that comprise the file to be sent and have TCP transmit that data in the order we gave it. However, just as special circumstances can require the “push” function we saw in the previous topic, there are cases where we may **not** want to always send all data over in the exact sequence it was given to TCP.

The most common example of this is when it is necessary to *interrupt* an application's data transfer. Suppose we have an application that sends large files in both directions between two devices. The user of the application realizes that the wrong file is being transferred. When he or she tells the application to stop the file being sent, we want this to be communicated to the other end of the TCP connection immediately. We don't want the “abort” command to just be placed at the end of the line after the file we are trying to send!

Prioritizing Data For Transfer

TCP provides a means for a process to prioritize the sending of data in the form of its “urgent” feature. To use it, the process that needs to send urgent data enables the function and sends the urgent data to its TCP layer. TCP then creates a special TCP segment that has the *URG* control bit set to 1. It also sets the *Urgent Pointer* field to an offset value that points to the last byte of urgent data in the segment. So, for example, if the segment contained 400 bytes of urgent data followed by 200 bytes of regular data, the *URG* bit would be set and the *Urgent Pointer* field would have a value of 400.

Upon receipt of a segment with the *URG* flag set to 1, the receiving device looks at the *Urgent Pointer* and from its value determines which data in the segment is urgent. It then forwards the urgent data to the process with an indication that the data is marked as urgent by the sender. The rest of the data in the segment is processed normally.

Since we typically want to send urgent data, well, **urgently**, it makes sense that when such data is given to TCP, the “push” function is usually also invoked. This ensures that the urgent data is sent as soon as possible by the transmitting TCP and also forwarded up the protocol stack right away by the receiving TCP. Again, we need to remember that this does not guarantee the contents of the urgent segment. Using the “push” function **may** mean the segment contains only urgent data with no non-urgent data following, but again, an application cannot assume that this will always be the case.



Key Concept: To deal with situations where a certain part of a data stream needs to be sent with a higher priority than the rest, TCP incorporates an “urgent” function. When critical data needs to be sent, the application signals this to its TCP layer, which transmits it with the *URG* bit set in the TCP segment, bypassing any lower-priority data that may have already been queued for transmission.



TCP Reliability and Flow Control Features and Protocol Modifications

The main task of the Transmission Control Protocol is simple: packaging and sending data. Of course, almost every protocol packages and sends data. What distinguishes TCP from these protocols is [the sliding window mechanism](#) that controls the flow of data between devices. This system not only manages the basic data transfer process, it is also used to ensure that data is sent reliably, and also to manage the flow of data between devices to ensure that data is transferred efficiently without either device sending data faster than the other can receive it.

To enable TCP to provide the features and quality of data transfer that applications require, the protocol had to be enhanced beyond the simplified data transfer mechanism we saw in preceding sections. Extra “smarts” needed to be given to the protocol to handle potential problems, and changes to the basic way that devices send data were implemented to avoid inefficiencies that might otherwise have resulted.

In this section I describe how TCP ensures that devices on a TCP connection communicate in a reliable and efficient manner. I begin with an explanation of the basic method by which TCP detects lost segments and retransmits them. I discuss some of the issues associated with TCP's acknowledgment scheme and an optional feature for improving its efficiency. I then describe the system by which TCP adjusts how long it will wait before deciding that a segment is lost. I discuss how the window size can be adjusted to implement flow control, and some of the issues involved in window size management. This includes a look at the infamous “Silly Window Syndrome” problem, and special heuristics for addressing issues related to small window size that modify the basic sliding windows scheme. I conclude with a discussion of TCP's mechanisms for handling and avoiding congestion.



Background Information: This section assumes that you are already familiar with TCP [sequence numbers and segments](#), and [the basics of the TCP sliding window mechanism](#). It also assumes you have already read [the section on TCP message formatting and data transfer](#). If not, you may want to review at least [the topic describing TCP data transfer mechanics](#); several of the topics in this section extend that simplified discussion of TCP data transfer to show what happens in non-ideal conditions.

TCP Segment Retransmission Timers and the Retransmission Queue

TCP's basic data transfer and acknowledgment mechanism uses a set of variables maintained by each device to implement the [sliding window acknowledgement system](#). These pointers keep track of the bytes of data sent and received by each device, as well as differentiating between acknowledged and unacknowledged transmissions. In the preceding section [I described this mechanism, and gave a simplified example showing how a client and server uses them for basic data transfer.](#)

One of the reasons why that example is simplified is that every segment that was transmitted by the server was received by the client, and vice-versa. It would be nice if we could always count on this happening, but as we know, in an Internet environment this is not realistic. Due to any number of conditions, such as hardware failure, corruption of an IP datagram or router congestion, a TCP segment may be sent but never received. To qualify as a reliable transport protocol, TCP must be able detect lost segments and *retransmit* them.

Managing Retransmissions Using the Retransmission Queue

The method for detecting lost segments and retransmitting them is conceptually simple. Each time we send a segment, we start a *retransmission timer*. This timer starts at a predetermined value and counts down over time. If the timer expires before an acknowledgment is received for the segment, we retransmit the segment.

TCP uses this basic technique but implements it in a slightly different way. The reason for this is the need to efficiently deal with many segments that may be unacknowledged at once, to ensure that they are each retransmitted at the appropriate time if needed. The TCP system works according to the following specific sequence:

- ① **Placement On Retransmission Queue, Timer Start:** As soon as a segment containing data is transmitted, a copy of the segment is placed in a data structure called the *retransmission queue*. A retransmission timer is started for the segment when it is placed on the queue. Thus, **every** segment is at some point placed in this queue. The queue is kept sorted by the time remaining in the retransmission timer, so the TCP software can keep track of which timers have the least time remaining before they expire.
- ② **Acknowledgment Processing:** If an acknowledgment is received for a segment before its timer expires, the segment is removed from the retransmission queue.
- ③ **Retransmission Timeout:** If an acknowledgment is **not** received before the timer for a segment expires, a *retransmission timeout* occurs, and the segment is automatically retransmitted.

Of course, we have no more guarantee that a retransmitted segment will be received than we had for the original segment. For this reason, after retransmitting a segment, it remains on the retransmission queue. The retransmission timer is reset, and the countdown begins again. Hopefully an acknowledgment will be received for the retransmission, but if not, the segment will be retransmitted again and the process repeated.

Certain conditions may cause even repeated retransmissions of a segment to fail. We don't want TCP to just keep retransmitting forever, so TCP will only retransmit a lost segment a certain number of times before concluding that there is a problem and terminating the connection.



Key Concept: To provide basic reliability for sent data, each device's TCP implementation uses a *retransmission queue*. Each sent segment is placed on the queue and a *retransmission timer* started for it. When an acknowledgment is received for the data in the segment, it is removed from the retransmission queue. If the timer goes off before an acknowledgment is received the segment is retransmitted and the timer restarted.

Recognizing When a Segment is Fully Acknowledged

One issue we have yet to discuss is how we know when a segment has been fully acknowledged. Retransmissions are handled on a segment basis, but TCP acknowledgments, as we have seen, are done on a cumulative basis using sequence numbers. Each time a segment is sent by Device *A* to Device *B*, *B* looks at the value of the *Acknowledgment Number* field in the segment. All bytes with sequence numbers lower than the value of this field have been received by *A*.

Thus, a segment sent by *B* to *A* is considered acknowledged when all of the bytes that were sent in the segment have a lower sequence number than the latest *Acknowledgment Number* sent by *B* to *A*. This is determined by calculating the last sequence number of the segment using its first byte number (in the *Sequence Number* field) and length of the segment's *Data* field.



Key Concept: TCP uses a *cumulative acknowledgment system*. The *Acknowledgment Number* field in a segment received by a device indicates that all bytes of data with sequence numbers less than that value have been successfully received by the other device. A segment is considered acknowledged when all of its bytes have been acknowledged; in other words, when an *Acknowledgment Number* containing a value larger than the sequence number of its last byte is received.

TCP Transaction Example with Retransmission

Let's use an example to clarify how acknowledgments and retransmissions work in TCP (illustrated in [Figure 223](#), to which you may wish to refer as you read on). Suppose the server in a connection sends out four contiguous segments (numbered starting with 1 for clarity):

1. **Segment #1:** *Sequence Number* field is 1 and segment length is 80. So the last sequence number in Segment #1 is 80.
2. **Segment #2:** *Sequence Number* field is 81 and segment length is 120. The last sequence number in Segment #2 is 200.
3. **Segment #3:** *Sequence Number* field is 201 and segment length is 160. The last sequence number in Segment #3 is 360.

-
4. **Segment #4:** *Sequence Number* field is 361 and segment length is 140. The last sequence number in Segment #4 is 500.

Again, these can be sent one after the other without having to wait for each preceding transmission to be acknowledged; this is a major benefit of TCP's sliding window mechanism.

Now let's say the client receives the first two transmissions. It will send back an acknowledgment with an *Acknowledgment Number* field value of 201. This tells the server that the first two segments have been successfully received by the client; they will be removed from the retransmission queue (and the server's send window will slide 200 bytes to the right). Segment #3 will remain on the retransmission queue until a segment with an *Acknowledgment Number* field value of 361 or higher is received; Segment #4 requires an acknowledgment value of 501 or greater.

Now, let's further suppose in this example that Segment #3 gets lost in transit, but Segment #4 is received. The client will store Segment #4 in its receive buffer, but will not be able to acknowledge it, because of TCP's cumulative acknowledgment system—acknowledging #4 would imply receipt of #3 as well, which never showed up. So the client will have to simply wait for #3. Eventually, the retransmission timer that the server started for Segment #3 will expire. The server will then retransmit Segment #3. It will be received by the client, which will then be able to acknowledge both #3 and #4 to the server.

There's another important issue here, however: how exactly the server should handle Segment #4. While the client is waiting for the missing Segment #3, the server is receiving no feedback; it doesn't know that #3 is lost, and it also doesn't know what happened to #4 (or any subsequent transmissions.) It is possible that the client has already received Segment #4 but just couldn't acknowledge it. Then again, maybe Segment #4 got lost as well. Some implementations may choose to only re-send Segment #3, while some may choose to re-send both Segment #3 and Segment #4. [This is an important issue that is discussed in more detail in the next topic.](#)

A final issue is what value we should use for the retransmission timer when we put a segment on the retransmission queue. If it is set too low, excessive retransmissions occur; if set too high, performance is reduced due to extraneous delays in re-sending lost segments. In fact, TCP cannot use a single number for this value; it must determine it dynamically using a process called [adaptive retransmission](#).

TCP Non-Contiguous Acknowledgment Handling and Selective Acknowledgment (SACK)

Computer science people sometimes use the term “elegant” to describe a simple but effective solution to a problem or need. I think the term applies fairly well to the cumulative acknowledgment method that is part of the TCP sliding window system. With a single number, returned in the *Acknowledgment Number* field of a TCP segment, the device sending the segment can acknowledge not just a single segment it has received from its connection peer, but possibly several of them. We saw how this works in [the topic on the fundamentals of sliding windows](#), and again in [the previous topic on retransmissions](#).

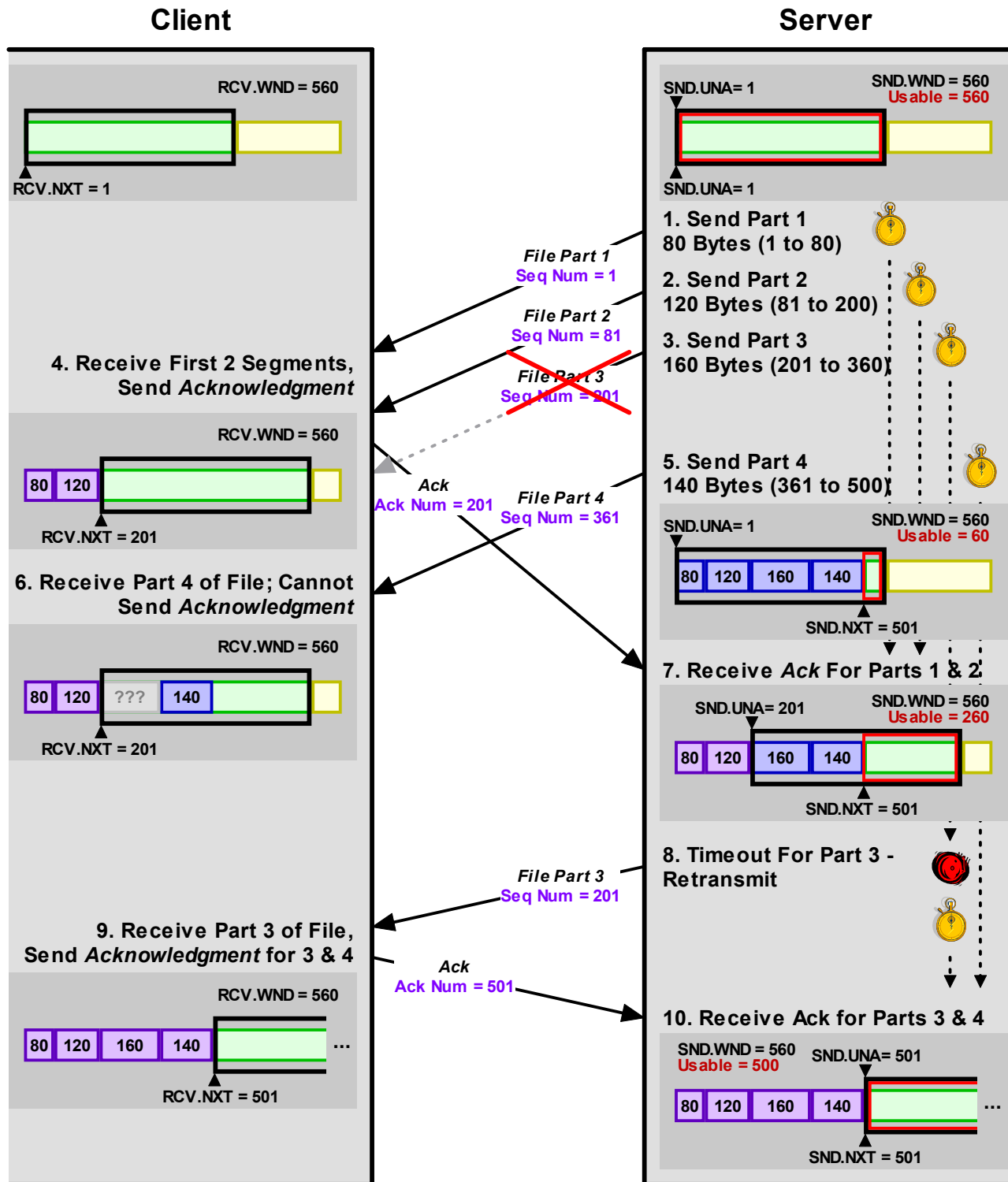

Figure 223: TCP Transaction Example With Retransmission

This diagram illustrates a simple transaction and shows the server's send pointers and client's receive pointers. The server sends three segments to the client in rapid succession, setting a retransmission timer for each. Parts 1 and 2 are received and the client sends an *Acknowledgment* for them; upon receipt of this *ACK*, 1 and 2 are taken off the retransmission queue. However, Part 3 is lost in transit. When Part 4 is received, the client cannot acknowledge it; this would imply receipt of the missing Part 3. Eventually the retransmission timer for Part 3 expires and it is retransmitted, at which time both Part 3 and Part 4 are acknowledged.

The Main Weakness of the TCP Sliding Window System: Handling Non-Contiguous Acknowledgments

Even the most elegant technique has certain weaknesses, however. In the case of the TCP acknowledgment system, it is the inability to effectively deal with the receipt of *non-contiguous* TCP segments. The *Acknowledgment Number* specifies that **all** sequence numbers lower than its value have been received by the device sending that number. If we receive bytes with sequence numbers in two non-contiguous ranges, there is no way to specify this with a single number.

This can lead to potentially serious performance problems, especially on internetworks that operate at high speed or over inherently unreliable physical networks. To see what the problem is, let's go back to the example in the previous topic. There, the server sent four segments, and received back an acknowledgment with an *Acknowledgment Number* value of 201. Segment #1 and Segment #2 were thus considered acknowledged. They would be removed from the retransmission queue, and this would also allow the server's send window to slide 80+120 bytes to the right, allowing 200 more bytes of data to be sent.

However, let's again imagine that Segment #3, starting with sequence number 201, "disappears". Since the client never receives this segment, it can never send back a acknowledgment with an *Acknowledgment Number* higher than 201. This causes the sliding window system to get "stuck". The server can continue to send additional segments until it fills up the client's receive window, but until the client sends another acknowledgment, the server's send window will not slide.

The other problem we saw is that if Segment #3 gets lost, the client has no way to tell the server that it has in fact received any **subsequent** segments. It's entirely possible that the client does receive the server's Segment #4, and in addition, later segments sent until the window filled up. But the client can't send an acknowledgment with a value of 501 to indicate receipt of Segment #4, *because this implies receipt of Segment #3 as well*.



Note: In some cases the client may still send an acknowledgment upon receipt of Segment #4, but only containing a repeated acknowledgment of the bytes up to the end of Segment #2. [See the topic on congestion avoidance for an explanation.](#)

And here we see the drawback of the single-number, cumulative acknowledgment system of TCP. We could imagine a "worst-case scenario" in which the server is told it has a window of 10,000 bytes, and sends 20 segments of 500 bytes each. The first segment is lost and the other 19 received. But since it is the first segment that never showed up, none of the other 19 segments can be acknowledged!



Key Concept: TCP's acknowledgment system is *cumulative*. This means that if a segment is lost in transit, no subsequent segments can be acknowledged until the missing one is retransmitted and successfully received.

Policies For Dealing with Retransmission When Unacknowledged Segments Exist

This then leads to an important question: how do we handle retransmissions when there are subsequent segments outstanding beyond the lost segment? In our example above, when the server experiences a retransmission timeout on Segment #3, it must decide what to do about Segment #4, when it simply doesn't know whether or not the client received it. In our "worst-case scenario", we have 19 segments that may or may not have shown up at the client after the first one that was lost.

We have two different possible ways to handle this situation.

Retransmit Only Timed-Out Segments

This is the more "conservative", or if you prefer, "optimistic" approach. We retransmit only the segment that timed out, hoping that the other segments beyond it were successfully received.

This method is best if the segments after the timed-out segment actually showed up. It doesn't work so well if they did not. In the latter case, each segment would have to time out individually and be retransmitted. Imagine that in our "worst-case scenario" that all 20 500-byte segments were lost. We would have to wait for Segment #1 to time out and be retransmitted. This retransmission would be acknowledged (hopefully) but then we would get stuck waiting for Segment #2 to time out and be resent. We would have to do this many times.

Retransmit All Outstanding Segments

This is the more "aggressive" or "pessimistic" method. Whenever a segment times out we re-send not only it but all other segments that are still unacknowledged.

This method ensures that any time there is a hold up with acknowledgments, we "refresh" all outstanding segments to give the other device an extra chance at receiving them in case they too were lost. In the case where all 20 segments were lost, this saves substantial amounts of time over the "optimistic" approach. The problem here is that these retransmissions may not be necessary. If the first of 20 segments was lost and the other 19 were actually received, we'd be re-sending 9,500 bytes of data (plus headers) for no reason.

There Is No Ideal Answer

Since TCP doesn't know whether these other segments showed up, it cannot know which method is better. It must simply make an “executive decision” to use one approach or the other, and hope for the best. In the example of the previous topic, as shown in [Figure 223](#), I demonstrated the “conservative” approach—only the lost segment of the file was retransmitted. In contrast, [Figure 224](#) shows the “aggressive” approach to retransmission.



Key Concept: There are two approaches to handling retransmission in TCP. In the more “conservative” approach, only the segments whose timers expire are retransmitted; this saves bandwidth but may cause performance degradation if many segments in a row are lost. The alternative is that when a segment’s retransmission timer expires, both it and all subsequent unacknowledged segments are retransmitted. This provides better performance if many segments are lost but may waste bandwidth on unnecessary retransmissions.

A Better Solution: Selective Acknowledgment (SACK)

It is in fact this lack of knowledge about non-contiguous segments that is the core of the problem with non-contiguous segments. The solution is to extend the basic TCP sliding window algorithm with an optional feature that allows a device to acknowledge non-contiguous segments individually. This feature, introduced in RFC 1072 and refined in RFC 2018, is called TCP *selective acknowledgment*, abbreviated *SACK*.

To use SACK, the two devices on the connection must both support the feature, and must enable it by [negotiating](#) the *Selective Acknowledge Permitted (SACK-Permitted)* option in the *SYN* segment they use to establish the connection. Assuming this is done, either device is then permitted to include in a regular TCP segment a *Selective Acknowledgment (SACK)* option. This option contains a list of sequence number ranges of segments of data that have been received but have not been acknowledged since they are non-contiguous.

Each device modifies its retransmission queue so that each segment includes a flag that is set to 1 if the segment has been selectively acknowledged—the *SACK* bit. The device then uses a modified version of the “aggressive” method above, where upon retransmission of a segment all later segments are also retransmitted **unless** their *SACK* bits are set to 1.

For example, in our four-segment case, if the client receives Segment #4 but not Segment #3, when it sends back a segment with an *Acknowledgment Number* field value of 201 (for #1 and #2), it can include a *SACK* option that specifies “I have received bytes 361 through 500, but they are not yet acknowledged”. This can also be done in a second acknowledgment segment if Segment #4 arrives well after #1 and #2. The server recognizes this as the range of bytes for Segment #4, and turns on the *SACK* bit for Segment #4. When Segment #3 is retransmitted, the server sees the *SACK* bit for Segment #4 on and does not retransmit it. This is illustrated in [Figure 225](#).

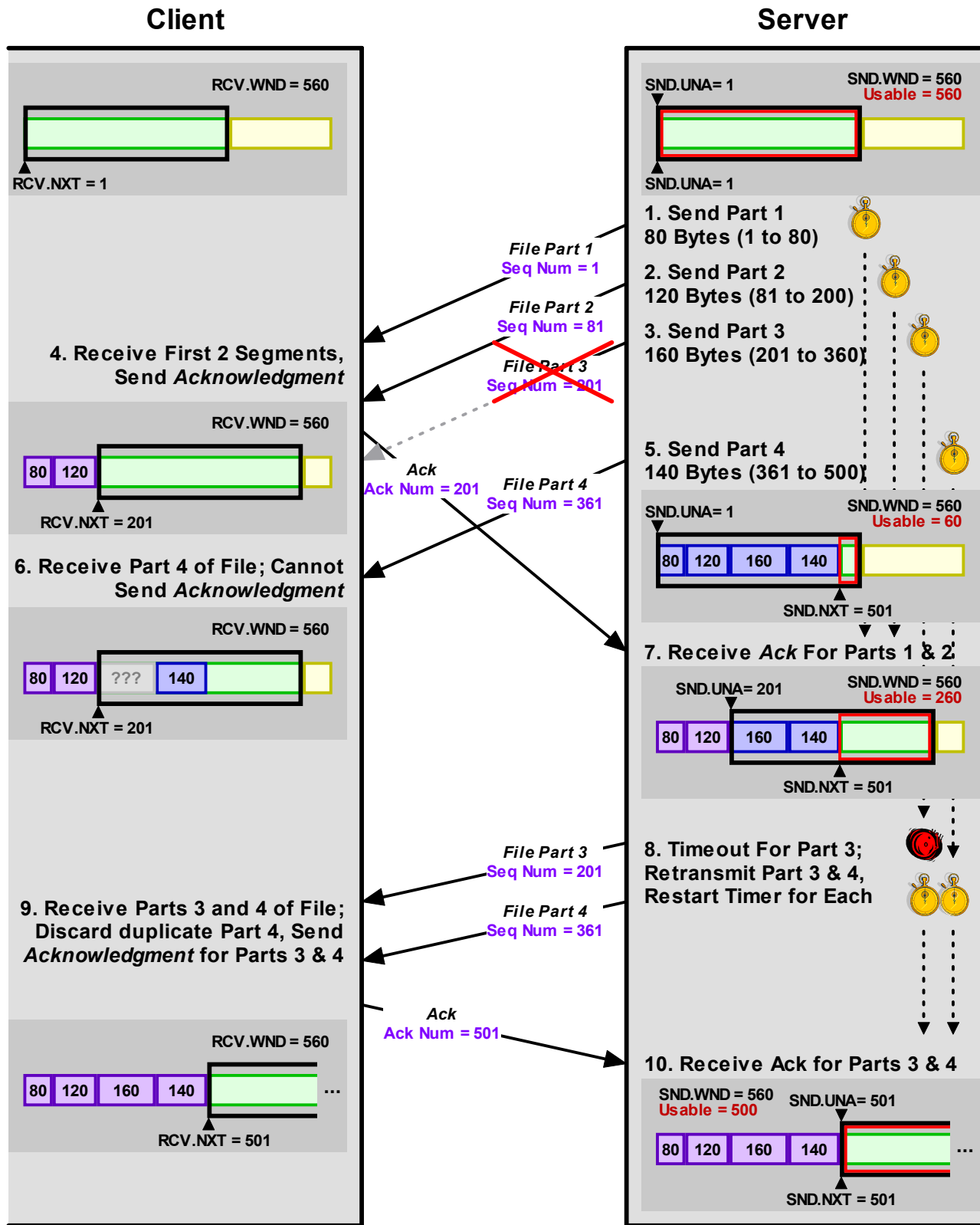

Figure 224: TCP "Aggressive" Retransmission Example

This example is the same as that of [Figure 223](#) except that here the server is taking an "aggressive" approach to retransmitting lost segments. When segment #3 times out, both #3 and #4 are retransmitted and their retransmission timers restarted. (In this case #4 already arrived so this extra transmission was not useful.)

After Segment #3 is retransmitted, the SACK bit for Segment #4 is cleared. This is done for robustness, to handle cases where for whatever reason the client “changes its mind” about having received Segment #4. The client **should** send an acknowledgment with an *Acknowledgment Number* of 501 or higher, indicating “official” receipt of Segments #3 and #4. If this does not happen, the server must receive another selective acknowledge for Segment #4 to turn its SACK bit back on. Otherwise it will be automatically re-sent when its timer expires, or when Segment #3 is retransmitted.



Key Concept: The optional TCP *selective acknowledgment* feature provides a more elegant way of handling subsequent segments when a retransmission timer expires. When a device receives a non-contiguous segment it includes a special *Selective Acknowledgment (SACK)* option in its regular acknowledgment that identifies non-contiguous segments that have already been received, even if they are not yet acknowledged. This saves the original sender from having to retransmit them.

TCP Adaptive Retransmission and Retransmission Timer Calculations

Whenever a TCP segment is transmitted, a copy of it is also placed on the [retransmission queue](#). When the segment is placed on the queue, a retransmission timer is started for the segment, which starts from a particular value and counts down to zero. It is this timer that controls how long a segment can remain unacknowledged before the sender gives up, concludes that it is lost and sends it again.

The length of time we use for retransmission timer is thus very important. If it is set too low, we might start retransmitting a segment that was actually received, because we didn't wait long enough for the acknowledgment of that segment to arrive. Conversely, if we set the timer too long, we waste time waiting for an acknowledgment that will never arrive, reducing overall performance.

Difficulties in Choosing the Duration of the Retransmission Timer

Ideally, we would like to set the retransmission timer to a value just slightly larger than the *round-trip time (RTT)* between the two TCP devices, that is, the typical time it takes to send a segment from a client to a server and the server to send an acknowledgment back to the client (or the other way around, of course). The problem is that there **is** no such “typical” round-trip time. There are two main reasons for this:

- ☉ **Differences In Connection Distance:** Suppose you are at work in the United States, and during your lunch hour you are transferring a large file between your workstation and a local server connection using 100 Mbps Fast Ethernet, at the same time you are downloading a picture of your nephew from your sister's personal Web site—which is connected to the Internet using an analog modem to an ISP in a small town near Lima, Peru. Would you want both of these TCP connections to use the same retransmission timer value? I certainly hope not!

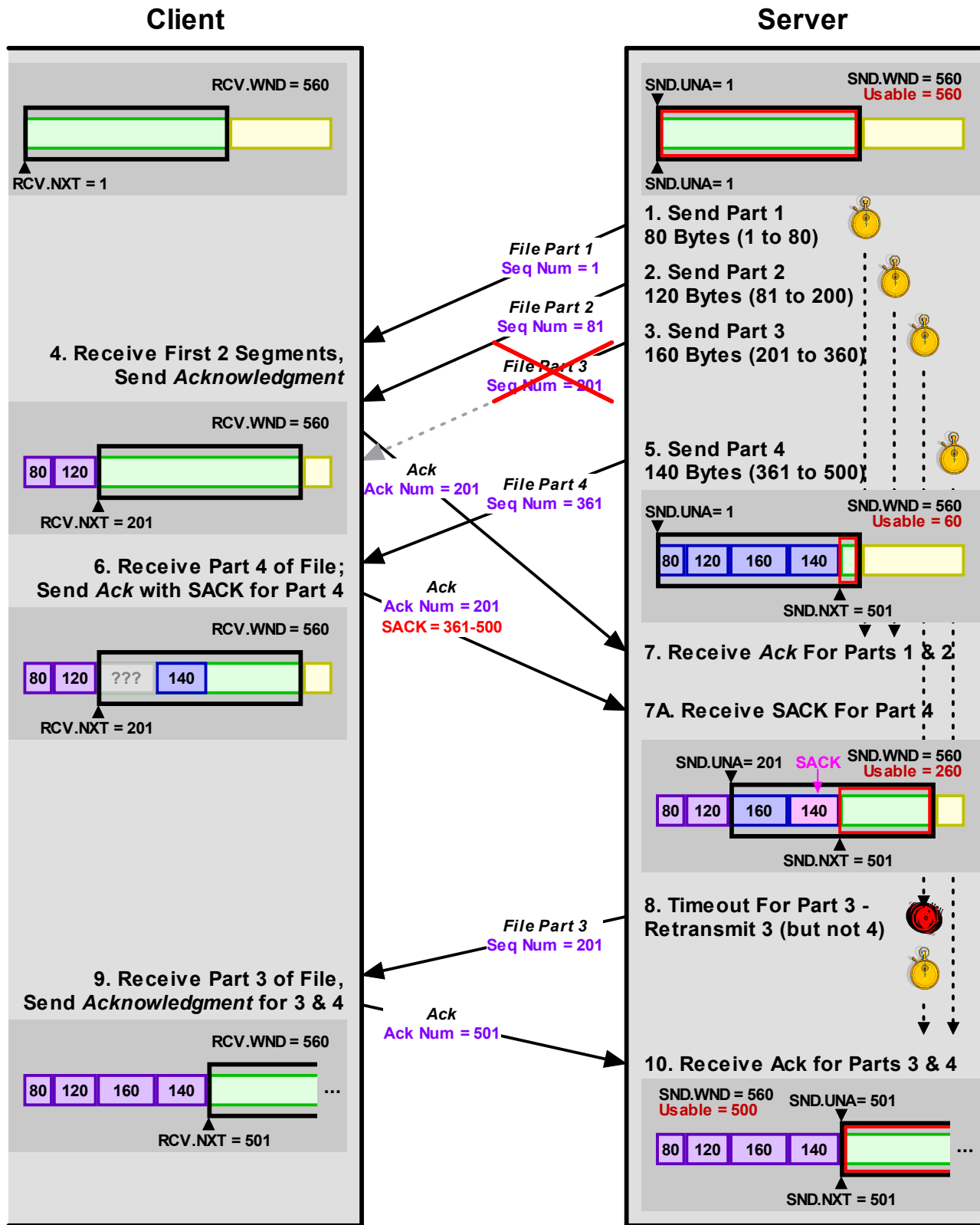

Figure 225: TCP Retransmission With Selective Acknowledgment (SACK)

This is the example from [Figure 223](#) and [Figure 224](#), changed to use the optional *selective acknowledge* feature. After receiving Parts 1, 2 and 4 of the file, the client sends an Acknowledgment for 1 and 2 that includes a SACK for Part 4. This tells the server not to re-send Part 4 when Part 3's timer expires.

-
- ☉ **Transient Delays and Variability:** The amount of time it takes to send data between any two devices will vary over time due to various happenings on the internet: fluctuations in traffic, router loads and so on. To see an example of this for yourself, try typing “ping www.tcpipguide.com” from the command line of an Internet-connected PC and you'll see how the reported times can vary.

Adaptive Retransmission Based on Round-Trip Time Calculations

It is for these reasons that TCP does not attempt to use a static, single number for its retransmission timers. Instead, TCP uses a dynamic, or *adaptive* retransmission scheme. TCP attempts to determine the approximate round-trip time between the devices, and adjusts it over time to compensate for increases or decreases in the average delay. The practical issues of how this is done are important, but are not covered in much detail in the main TCP standard. RFC 2988, *Computing TCP's Retransmission Timer*, discusses the issue extensively.

Round-trip times can “bounce” up and down, as we have seen, so we want to aim for an *average* RTT value for the connection. This average should respond to consistent movement up or down in the RTT without overreacting to a few very slow or fast acknowledgments. To allow this to happen, the RTT calculation uses a *smoothing* formula:

$$\text{New RTT} = (\alpha * \text{Old RTT}) + ((1-\alpha) * \text{Newest RTT Measurement})$$

Where “ α ” (alpha) is a *smoothing factor* between 0 and 1. Higher values of “ α ” (closer to 1) provide better smoothing and avoiding sudden changes as a result of one very fast or very slow RTT measurement. Conversely, this also slows down how quickly TCP reacts to more sustained changes in round-trip time. Lower values of alpha (closer to 0) make the RTT change more quickly in reaction to changes in measured RTT, but can cause “over-reaction” when RTTs fluctuate wildly.

Acknowledgment Ambiguity

Measuring the round-trip time between two devices is simple in concept: note the time that a segment is sent, note the time that an acknowledgment is received, and subtract the two. The measurement is more tricky in actual implementation, however. One of the main potential “gotchas” occurs when a segment is assumed lost and is retransmitted. The retransmitted segment carries nothing that distinguishes it from the original. When an acknowledgment is received for this segment, it's unclear as to whether this corresponds to the retransmission or the original segment. (Even though we decided the segment was lost and retransmitted it, it's possible the segment eventually got there, after taking a long time; or that the segment got there quickly but the ***acknowledgment*** took a long time!)

This is called *acknowledgment ambiguity*, and is not trivial to solve. We can't just decide to assume that an acknowledgment always goes with the oldest copy of the segment sent, because this makes the round-trip time appear too high. We also don't want to just assume an acknowledgment always goes with the latest sending of the segment, as that may artificially lower the average round-trip time.

Refinements to RTT Calculation and Karn's Algorithm

TCP's solution to round-trip time calculation is based on the use of a technique called *Karn's algorithm*, after its inventor, Phil Karn. The main change this algorithm makes is the separation of the calculation of average round-trip time from the calculation of the value to use for timers on retransmitted segments.

The first change made under Karn's algorithm is to not use measured round-trip times for any segments that are retransmitted in the calculation of the overall average round-trip time for the connection. This completely eliminates the problem of acknowledgment ambiguity.

However, this by itself would not allow increased delays due to retransmissions to affect the average round-trip time. For this, we need the second change: incorporation of a *timer backoff* scheme for retransmitted segments. We start by setting the retransmission timer for each newly-transmitted segment based on the current average round-trip time. When a segment is retransmitted, the timer is not reset to the same value it was set for the initial transmission. It is "backed off" (increased) using a multiplier (typically 2) to give the retransmission more time to be received. The timer continues to be increased until a retransmission is successful, up to a certain maximum value. This prevents retransmissions from being sent too quickly and further adding to network congestion.

Once the retransmission succeeds, the round-trip timer is kept at the longer (backed-off) value until a valid round-trip time can be measured on a segment that is sent and acknowledged without retransmission. This permits a device to respond with longer timers to occasional circumstances that cause delays to persist for a period of time on a connection, while eventually having the round-trip time settle back to a long-term average when normal conditions resume.



Key Concept: TCP uses an adaptive retransmission scheme that automatically adjusts the amount of time to which retransmission timers are set, based on the average amount of time it takes to send segments between devices. This helps avoid retransmitting potentially lost segments too quickly or too slowly.

TCP Window Size Adjustment and Flow Control

We have seen the importance of the concept of *window size* to TCP's sliding window mechanism. In a connection between a client and a server, the client tells the server the number of bytes it is willing to receive at one time from the server; this is the client's *receive window*, which becomes the server's *send window*. Likewise, the server tells the client how many bytes of data it is willing to take from the client at one time; this is the server's *receive window* and the client's *send window*.

The use of these windows is demonstrated in [the topic discussing TCP's basic data transfer and acknowledgment mechanism](#). However, just as the example in that topic was simplified because I didn't show what happens with lost segments, there's another way that it doesn't reflect the real world conditions of an actual Internet: the send and receive window sizes never changed during the course of communication.

Impact of Buffer Management on TCP Window Size

To understand why the window size may fluctuate, we need to understand what it represents. The simplest way of considering the window size is that it indicates the size of the device's receive buffer for the particular connection. That is, window size represents how much data a device can handle from its peer at one time before it is passed to the application process. Let's consider the aforementioned example. I said that the server's window size was 360. This means the server is willing to take no more than 360 bytes at a time from the client.

When the server receives data from the client, it places it into this buffer. The server must then do two distinct things with this data:

- ☉ **Acknowledgment:** The server must send an acknowledgment back to the client to indicate that the data was received.
- ☉ **Transfer:** The server must process the data, transferring it to the destination application process.

It is critically important that we differentiate between these two activities. Unfortunately, the TCP standards don't do a great job in this regard, which makes them very difficult to understand. The key point is that in the basic sliding windows system, data is acknowledged when received, but ***not necessarily*** immediately transferred out of the buffer. This means that it is possible for the buffer to fill up with received data faster than the receiving TCP can empty it. When this occurs, the receiving device may need to adjust window size to prevent the buffer from being overloaded.

Since the window size can be used in this manner to manage the rate at which data flows between the devices at the ends of the connection, it is the method by which TCP implements *flow control*, one of the “classical” jobs of the transport layer. Flow control is vitally important to TCP, as it is the method by which devices communicate their status to each other. By reducing or increasing window size, the server and client each ensure that the other device sends data just as fast as the recipient can deal with it.

Reducing Send Window Size To Reduce The Rate Data Is Sent

Let's go back to our earlier example so I can hopefully explain better what I mean, but let's make a few changes. First, to keep things simple, let's just look at the transmissions made from the client to the server, not the server's replies (other than acknowledgments)—this is illustrated in [Figure 222](#). As before, the client sends 140 bytes to the server. After sending the 140 bytes, the client has 220 bytes remaining in its usable window—360 in the send window less the 140 bytes it just sent.

Sometime later, the server receives the 140 bytes and puts them in the buffer. Now, in an “ideal world”, the 140 bytes go into the buffer, are acknowledged and immediately removed from the buffer. Another way of thinking of this is that the buffer is of “infinite size” and can hold as much as the client can send. The buffer's free space remains 360 bytes in size, so the same window size can be advertised back to the client. This was the “simplification” in the previous example.

As long as the server can process the data as fast as it comes in, it will keep the window size at 360 bytes. The client, upon receipt of the acknowledgment of 140 bytes and the same window size it had before, “slides” the full 360-byte window 140 bytes to the right. Since there are now 0 unacknowledged bytes, the client can now once again send 360 bytes of data. These correspond to the 220 bytes that were formerly in the usable window, plus 140 new bytes for the ones that were just acknowledged.

In the “real world”, however, that server might be dealing with dozens, hundreds or even thousands of TCP connections. The TCP might not be able to process the data immediately. Alternately, it is possible the application itself might not be ready for the 140 bytes for whatever reason. In either case, the server's TCP may not be able to immediately remove all 140 bytes from the buffer. If so, upon sending an acknowledgment back to the client, will want to change the window size that it advertises to the client, to reflect the fact that the buffer is partially filled.

Suppose that we receive 140 bytes as above, but are able to send only 40 bytes to the application, leaving 100 bytes in the buffer. When we send back the acknowledgment for the 140 bytes, the server can reduce its send window by 100, to 260. When the client receives this segment from the server it will see the acknowledgment of the 140 bytes sent and slide its window 140 bytes to the right. However, as it slides this window, it reduces its size to only 260 bytes. We can consider this like sliding the *left edge* of the window 140 bytes, but the *right edge* only 40 bytes. The new, smaller window ensures that the server receives a maximum of 260 bytes from the client, which will fit in the 260 bytes remaining in its receive buffer. This is illustrated in the first exchange of messages (Steps #1 through #3) at the top of [Figure 226](#).

Reducing Send Window Size To Stop The Sending of New Data

What if the server is so bogged down that it can't process **any** of the bytes received? Let's suppose that the next transmission from the client is 180 bytes in size, but the server is so busy it can't remove any of them. It could buffer the 180 bytes and in the acknowledgment it sends for those bytes, reduce the window size by the same amount: from 260 to 80. When the client received the acknowledgment for 180 bytes it would see the window size had reduced by 180 bytes as well. It would “slide” its window by the same amount as the window size was reduced! This is effectively like the server saying “I acknowledge receipt of 180 bytes, but I am not allowing you to send any new bytes to replace them”.

Another way of looking at this is that the left edge of the window slides 180 bytes while the right edge remained fixed. And as long as the right edge of the window doesn't move, the client can't send any more data than it could before receipt of the acknowledgment. This is the middle exchange (Steps #4 to #6) in [Figure 226](#).

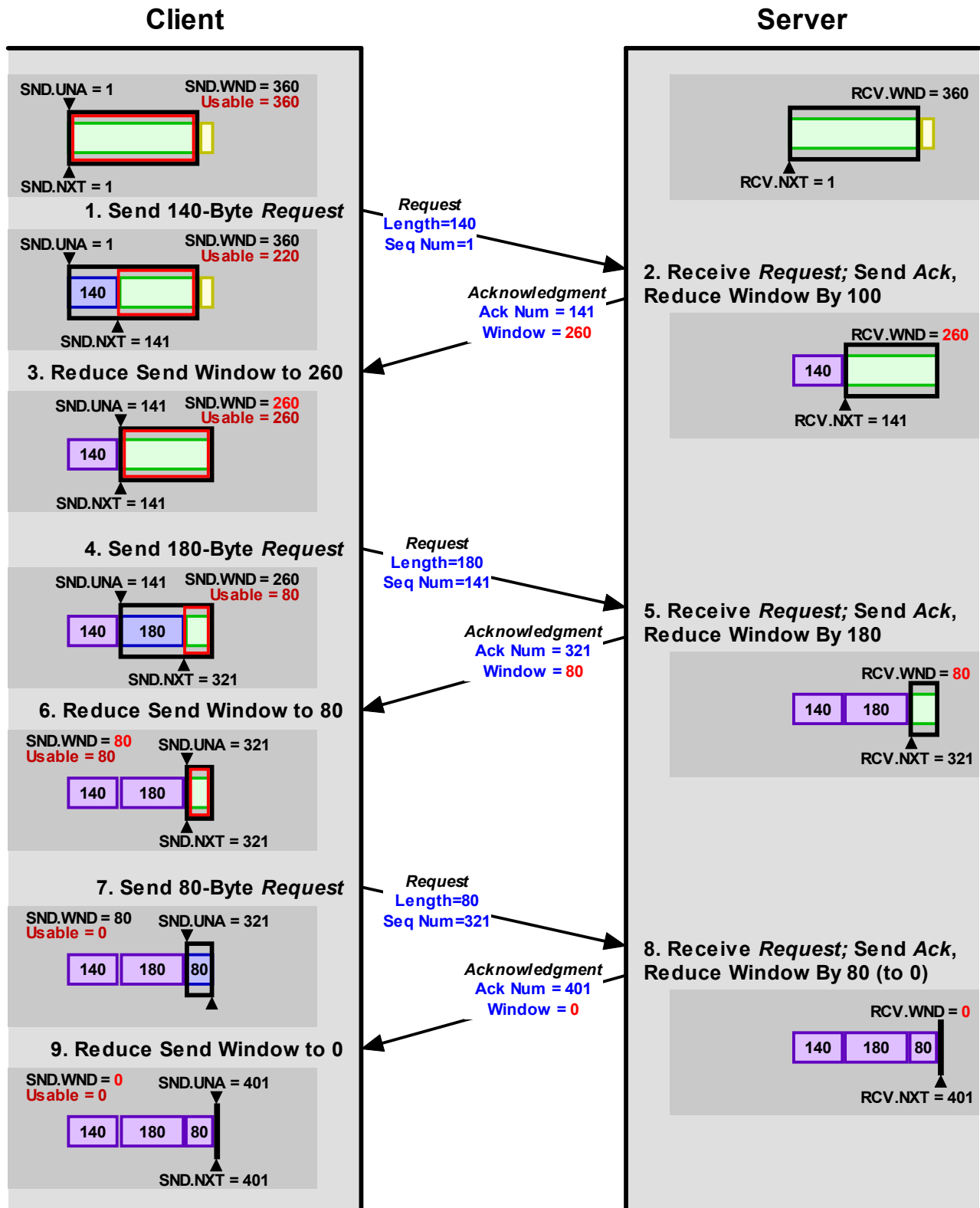

Figure 226: TCP Window Size Adjustments and Flow Control

This diagram shows three message cycles, each of which results in the server reducing its receive window. In the first, the server reduces it from 360 to 260, so the client's usable window can only increase by 40 when it gets the server's *Acknowledgment*. In the second and third the server reduces the window size by the amount of data it receives, which temporarily freezes the client's send window size, halting it from sending new data.

Closing the Send Window

The process of window adjustment can continue, and of course, can be done by both devices—we are just only considering the client-sends-to-server side of the equation here. If the server continues to receive data from the client faster than it can pump it out to the application, it will continue to reduce the size of its receive window. To continue our example above, suppose that after the send window is reduced to 80, the client sends a third request, this one 80 bytes in length, but the server is still busy. The server then reduces its window all the way down to 0, which is called *closing* the window. This tells the client the server is very overloaded, and it should stop routine sending of data entirely, as shown in the bottom third of [Figure 226](#). Later on, when the server is less loaded down, it can increase the window size for this connection back up again, permitting more data to be transferred.

While conceptually simple, flow control using window size adjustment can be very tricky. If we aren't careful about how we make changes to window size, we can introduce serious problems in the operation of TCP. There are also special situations that can occur, especially in cases where the window size is made small in response to a device becoming busy. The next two topics explore [window management issues](#), as well as [changes that need to be made to the basic sliding windows system](#) to address them.



Key Concept: The TCP sliding window system is used not just for ensuring reliability through acknowledgments and retransmissions—it is also the basis for TCP's *flow control* mechanism. By increasing or reducing the size of its receive window, a device can raise or lower the rate at which its connection partner sends it data. In the case where a device becomes extremely busy, it can even reduce the receive window to zero, closing it; this will halt any further transmissions of data until the window is reopened.

TCP Window Management Issues

Each of the two devices on a TCP connection can adjust the window size it advertises to the other, [to control the flow of data over the connection](#). Reducing the size of the window forces the other device to send less data; increasing the window size lets more data flow. In theory, we should be able to just let the TCP software on each of the devices change the window size as needed to match the speed at which data both enters the buffer and is removed from it to be sent to the receiving application.

Problems Associated With "Shrinking" The TCP Window

Unfortunately, certain changes in window size can lead to undesirable consequences. These can occur both when the size of the window is reduced and when it is increased. For this reason, there are a few issues related to *window size management* that we need to consider. As in previous topics, we'll use for illustration a modification of the same client/server example first shown in [the topic explaining the basic TCP data transfer process](#).

One window size management matter is related to just how quickly a device reduces the size of its receive window when it gets busy. Let's say the server starts with a 360 byte receive window, as in the aforementioned example, and receives 140 bytes of data that it acknowledges, but cannot remove from the buffer immediately. The server can respond by reducing the size of the window it advertises back to the client. We even discussed in [the previous topic](#) the case where no bytes can be removed from the buffer at all, so the window size is reduced by the same 140 bytes that were added to the buffer. This “freezes” the right edge of the client's send window so it cannot send any additional data when it gets an acknowledgment.

What if the server were so overloaded that we actually needed to reduce the size of the **buffer** itself? Say memory was short and the operating system said “I know you have 360 bytes allocated for the receive buffer for this connection, but I need to free up memory so now you only have 240”. The server still can't immediately process the 140 bytes it received, so it would need to drop the window size it sent back to the client all the way from 360 bytes down to 100 (240 in the total buffer less the 140 already received).

In effect, doing this actually moves the right edge of the client's send window *back to the left*. It says “not only can't you send more data when you receive this acknowledgment, but you now can send **less**”. In TCP parlance, this is called *shrinking the window*.

There's a very serious problem with doing this, however: while the original 140 bytes were in transit from the client to the server, the client still thought it had 360 bytes of total window, of which 220 bytes were *usable* (360 less 140). The client may well have already sent some of that 220 bytes of data to the server before it gets notification that the server has shrunk the window! If so, and the server reduces its buffer to 240 bytes with 140 used, when those 220 bytes show up at the server, only 100 will fit and any additional ones will need to be discarded. This will force the client to have to retransmit that data, which is inefficient. [Figure 227](#) illustrates graphically how this situation would play out.

Reducing Buffer Size Without “Shrinking” the Window

To prevent this from occurring, TCP adds a simple rule to the basic sliding window mechanism: a device is not allowed to shrink the window. Note that there is a potential terminology ambiguity here. The words “shrinking” and “reducing” are sometimes used synonymously in colloquial discussions. As we've seen, there's nothing wrong with **reducing** the size of the window. The problem of “shrinking the window” only refers to the case where we reduce the window size so much that we contradict a prior window advertisement by *taking back* permission to send a certain number of bytes.

Another way of looking at this is that *shrinking* occurs whenever the server sends back a window size advertisement smaller than what the client considers its usable window size to be at that time. In this case, the server shrunk the window because at the time it was acknowledging the 140 bytes, it sent back a window size of 100, which is less than the 220-byte usable window the client had then.

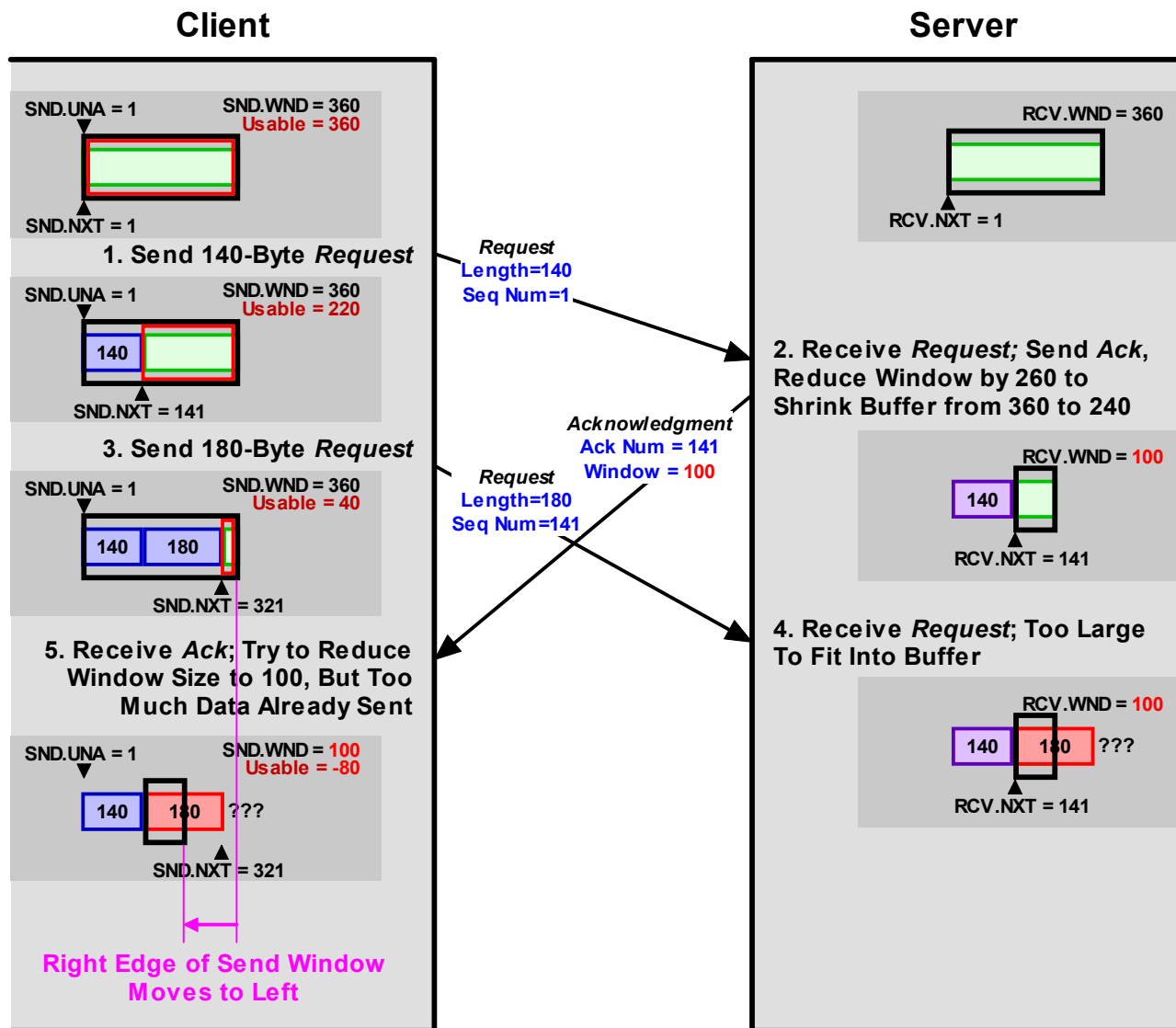

Figure 227: The Problem With “Shrinking” The TCP Window

In this modification of the example of Figure 226, the client begins with a usable window size of 360. It sends a 140-byte segment and then a short time thereafter sends one of 180 bytes. The server is busy, however, and when it receives the first transmission decides to reduce its buffer to 240 bytes. It holds the 140 bytes just received and reduces its receive window all the way down to 100. When the client’s 180-byte segment arrives, there is only room for 100 of the 180 bytes in the server’s buffer. When the client gets the new window size advertisement of 100, it will have a problem because it already has 180 bytes sent but not acknowledged.

Of course, there may well be cases where we **do** need to reduce a buffer, so how should this be handled? Instead of shrinking the window, the server must be more patient. In the example above where the buffer needs to be reduced to 240, the server must send back a window size of 220, freezing the right edge of the client’s send window. The client can still fill the 360 byte buffer, but cannot send more than that. As soon as 120 bytes are removed from the server’s receive buffer, the buffer can then be reduced in size to 240 bytes with no data loss. Then the server can resume normal operation, increasing the window size as bytes are taken from the receive buffer.



Key Concept: A phenomenon called *shrinking the window* occurs when a device reduces its receive window so much that its partner device's usable transmit window shrinks in size (meaning that the right edge of its send window moves to the left). Since this can result in data already in transit having to be discarded, devices must instead reduce their receive window size more gradually.

Handling a Closed Window and Sending Probe Segments

Another special window management problem is how to deal with the case where a device must reduce the send window size all the way down to zero. This is called *closing the receive window*. Since the server's receive window is the client's send window, reducing its size to zero means the client cannot send any more data, as we saw at the end of the example in the previous topic. This situation continues until the client receives from the server a new acknowledgment with a non-zero *Window* field, which reopens the window. Then the client is able to send again.

The problem with this situation is that the client is dependent upon receipt of the “window opening” segment from the server. Like all TCP segments, this segment is carried over IP, which is unreliable. Remember, TCP is reliable only because it acknowledges sent data and retransmits lost data if necessary, but it can never **guarantee** that any particular segment gets to its destination. This means that when the server tries to re-open the window with an acknowledgment segment containing a larger *Window* field, it's possible that the client never gets the message. The client might conclude that a problem had occurred and terminate the connection.

To prevent this from happening, the client can regularly send special *probe* segments to the server. The purpose of these probes is to prompt the server to send back a segment containing the current window size. The probe segment can contain either zero or one byte of data, even when the window is closed. The probes will continue to be sent periodically until the window reopens, with the particular implementation determining the rate at which the probes are generated.

When the server decides to reopen the closed window, there is another potential pitfall: opening the window to too small a value. In general, when the receive window is too small, this leads to the generation of many small segments, greatly reducing the overall efficiency of TCP. [The next topic](#) explores this well-known problem and how it is resolved through changes to the basic sliding windows mechanism.



Key Concept: A device that reduces its receive window to zero is said to have *closed* the window. The other device's send window is thus closed; it may not send regular data segments. It may, however, send *probe* segments to check the status of the window, thus making sure it does not miss notification when the window reopens.

TCP "Silly Window Syndrome" and Changes To the Sliding Window System For Avoiding Small-Window Problems

In [the topic describing TCP's Maximum Segment Size \(MSS\) parameter](#), I explained the trade-off in determining the optimal size of TCP segments. If segments are too large, we risk having them become fragmented at the IP level. Too small, and we get greatly reduced performance because we are sending a small amount of data in a segment with at least 40 bytes of header overhead. We also use up valuable processing time that is required to handle each of these small segments.

The MSS parameter ensures that we don't send segments that are too large—TCP is not allowed to create a segment larger than the MSS. Unfortunately, the basic sliding windows mechanism doesn't provide any *minimum* size of segment that can be transmitted. In fact, not only is it **possible** for a device to send very small, inefficient segments, the simplest implementation of flow control using unrestricted window size adjustments **ensures** that under conditions of heavy load, window size will become small, leading to significant performance reduction!

How Silly Window Syndrome Occurs

To see how this can happen, let's consider an example that is a variation on the one we've been using so far in this section. We'll assume the MSS is 360 and a client/server pair where again, the server's initial receive window is set to this same value, 360. This means the client can send a "full-sized" segment to the server. As long as the server can keep removing the data from the buffer as fast as the client sends it, we should have no problem. (In reality the buffer size would normally be larger than the MSS.)

Now, imagine that instead, the server is bogged down for whatever reason while the client needs to send it a great deal of data. For simplicity, let's say that the server is only able to remove 1 byte of data from the buffer for every 3 it receives. Let's say it also removes 40 additional bytes from the buffer during the time it takes for the next client's segment to arrive. Here's what will happen:

1. The client's send window is 360, and it has lots of data to send. It immediately sends a 360 byte segment to the server. This uses up its entire send window.
2. When the server gets this segment it acknowledges it. However, it can only remove 120 bytes so the server reduces the window size from 360 to 120. It sends this in the *Window* field of the acknowledgment.
3. The client receives an acknowledgment of 360 bytes, and sees that the window size has been reduced to 120. It wants to send its data as soon as possible, so it sends off a 120 byte segment.
4. The server has removed 40 more bytes from the buffer by the time the 120-byte segment arrives. The buffer thus contains 200 bytes (240 from the first segment, less the 40 removed). The server is able to immediately process one-third of those 120 bytes, or 40 bytes. This means 80 bytes are added to the 200 that already remain in the buffer, so 280 bytes are used up. The server must reduce the window size to 80 bytes.

-
5. The client will see this reduced window size and send an 80-byte segment.
 6. The server started with 280 bytes and removed 40 to yield 240 bytes left. It receives 80 bytes from the client, removes one third, so 53 are added to the buffer, which becomes 293 bytes. It reduces the window size to 67 bytes (360-293).

This process, which is illustrated in [Figure 228](#), will continue for many rounds, with the window size getting smaller and smaller, especially if the server gets even more overloaded. Its rate of clearing the buffer may decrease even more, and the window may close entirely.

Let's suppose this happens. Now, eventually, the server will remove some of the data from this buffer. Let's say it removes 40 bytes by the time the first closed-window "probe" from the client arrives. The server then reopens the window to a size of 40 bytes. The client is still desperate to send data as fast as possible, so it generates a 40-byte segment. And so it goes, with likely all the remaining data passing from the client to the server in tiny segments until either the client runs out of data, or the server more quickly clears the buffer.

Now imagine the worst-case scenario. This time, it is the application process on the server that is overloaded. It is drawing data from the buffer one byte at a time. Every time it removes a byte from the server's buffer, the server's TCP opens the window with a window size of exactly 1 and puts this in the *Window* field in an acknowledgment to the client. The client then sends a segment with exactly one byte, refilling the buffer until the application draws off the next byte.

The Cause of Silly Window Syndrome: Inefficient Reductions of Window Size

None of what we have seen above represents a *failure* per se of the sliding window mechanism. It is working properly to keep the server's receive buffer filled and to manage the flow of data. The problem is that the sliding window mechanism is only concerned with managing the buffer—it doesn't take into account the inefficiency of the small segments that result when the window size is micromanaged in this way.

In essence, by sending small window size advertisements we are "winning the battles but losing the war". Early TCP/IP researchers who discovered this phenomenon called it *silly window syndrome (SWS)*, a play on the phrase "sliding window system" that expresses their opinion on how it behaves when it gets into this state.

The examples above show how SWS can be caused by the advertisement of small window sizes by a receiving device. It is also possible for SWS to happen if the sending device isn't careful about how it generates segments for transmission, regardless of the state of the receiver's buffers.

For example, suppose the client TCP in the example above was receiving data from the sending application in blocks of 10 bytes at a time. However, the sending TCP was so impatient to get the data to the client that it took each 10-byte block and immediately packaged it into a segment, even though the next 10-byte block was coming shortly thereafter. This would result in a needless swarm of inefficient 10-data-byte segments.

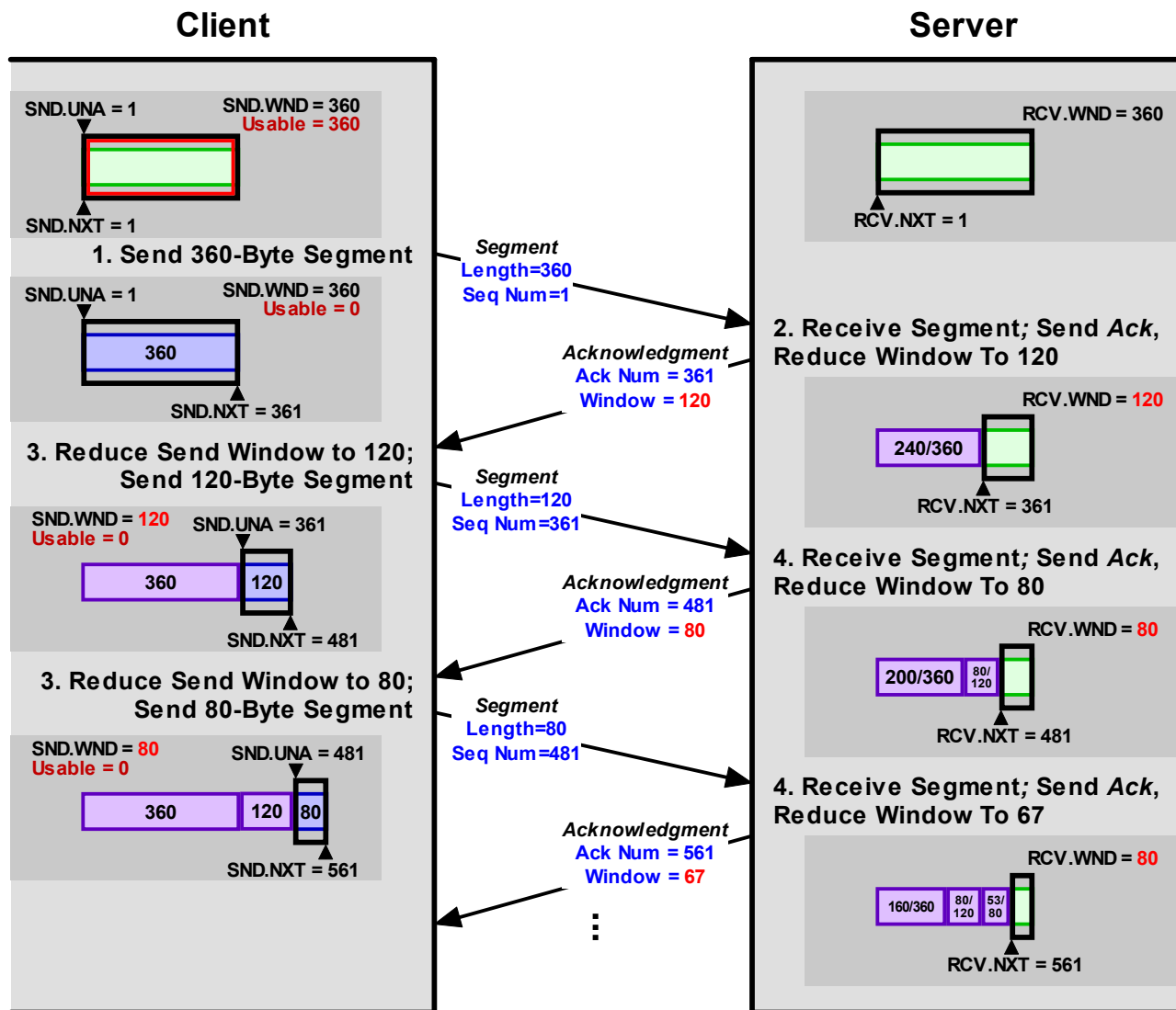

Figure 228: TCP “Silly Window Syndrome”

This diagram shows one example of how the phenomenon known as TCP *silly window syndrome* can arise.

The client is trying to send data as fast as possible to the server, which is very busy and cannot clear its buffers promptly. Each time the client sends data the server reduces its receive window. The size of the messages the client sends shrinks until it is only sending very small, inefficient segments.

(Note that in this diagram I have shown the server’s buffer fixed in position, rather than sliding to the right as in the other diagrams in this section. This way you can see the receive window decreasing in size more easily.



Key Concept: The basic TCP sliding window system sets no minimum size on transmitted segments. Under certain circumstances, this can result in a situation where many small, inefficient segments are sent, rather than a smaller number of large ones. Affectionately termed *silly window syndrome (SWS)*, this phenomenon can occur either as a result of a recipient advertising window sizes that are too small, or a transmitter being too aggressive in immediately sending out very small amounts of data.

Silly Window Syndrome Avoidance Algorithms

Since SWS is caused by the basic sliding window system not paying attention to the result of decisions that create small segments, dealing with SWS is conceptually simple: change the system so that we avoid small window size advertisements, and at the same time, also avoid sending small segments. Since both the sender and recipient of data contribute to SWS, changes are made to the behavior of both to avoid SWS. These changes are collectively termed *SWS avoidance algorithms*.

Receiver SWS Avoidance

Let's start with SWS avoidance by the receiver. As we saw in the initial example above, the receiver contributed to SWS by reducing the size of its receive window to smaller and smaller values due its being busy. This caused the right edge of the sender's send window to move by ever-smaller increments, leading to smaller and smaller segments. To avoid SWS, we simply make the rule that the receiver may not update its advertised receive window in such a way that this leaves too little usable window space on the part of the sender. In other words, we restrict the receiver from moving the right edge of the window by too small an amount. The usual minimum that the edge may be moved is either the value of the MSS parameter, or one-half the buffer size, whichever is less.

Let's see how we might use this in the example above. When the server receives the initial 360-byte segment from the client and can only process 120 bytes, it does not reduce the window size to 120. It reduces it all the way to 0, closing the window. It sends this back to the client, which will then stop and not send a small segment. Once the server has removed 60 more bytes from the buffer, it will now have 180 bytes free, half the size of the buffer. It now opens the window up to 180 bytes in size and sends the new window size to the client.

It will continue to only advertise either 0 bytes, or 180 or more, not smaller values in between. This seems to slow down the operation of TCP, but it really doesn't. Because the server is overloaded, the limiting factor in overall performance of the connection is the rate at which the server can clear the buffer. We are just exchanging many small segments for a few larger ones.

Sender SWS Avoidance and Nagle's Algorithm

SWS avoidance by the sender is accomplished generally by imposing “restraint” on the part of the transmitting TCP. Instead of trying to immediately send data as soon as we can, we wait to send until we have a segment of a reasonable size. The specific method for doing this is called *Nagle's algorithm*, named for its inventor, John Smith. (Just kidding, it was John Nagle. ☺) Simplified, this algorithm works as follows:

- ☉ As long as there is no unacknowledged data outstanding on the connection, as soon as the application wants, data can be immediately sent. For example, in the case of an interactive application like [Telnet](#), a single keystroke can be “pushed” in a segment.
- ☉ While there *is* unacknowledged data, all subsequent data to be sent is held in the transmit buffer and not transmitted until either all the unacknowledged data is acknowledged, or we have accumulated enough data to send a full-sized (MSS-sized) segment. This applies even if a “push” is requested by the user.

This might seem strange, especially the part about buffering data despite a push request! You might think this would cause applications like Telnet to “break”. In fact, Nagle's algorithm is a very clever method that suits the needs of both low-data-rate interactive applications like Telnet and high-bandwidth file transfer applications.

If you are using something like Telnet where the data is arriving very slowly (humans are very slow compared to computers), the initial data (first keystroke) can be pushed right away. The next keystroke has to wait for an acknowledgment, but this will probably come reasonably soon relative to how long it takes to hit the next key. In contrast, more conventional applications that generate data in large amounts will automatically have the data accumulated into larger segments for efficiency.

Nagle's algorithm is actually far more complex than this description, but this topic is already getting too long. RFC 896 discusses it in (much) more detail.



Key Concept: Modern TCP implementations incorporate a set of SWS avoidance algorithms. When receiving, devices are programmed not to advertise very small windows, waiting instead until there is enough room in the buffer for one of a reasonable size. Transmitters use Nagle's algorithm to ensure that small segments are not generated when there are unacknowledged bytes outstanding.

TCP Congestion Handling and Congestion Avoidance Algorithms

By changing the window size that a device advertises to a peer on a TCP connection, the device can increase or decrease the rate at which its peer sends it data. This is how the TCP sliding window system implements flow control between the two connected devices. We've seen how this works in the last few topics, including the changes required to the “basic” mechanism to ensure performance remains high by reducing the number of small segments sent.

Why TCP Must Monitor and Deal With Internetwork Congestion

Flow control is a very important part of regulating the transmission of data between devices, but it is limited in the following respect: it only considers what is going on within each of the devices on the connection, and **not** what is happening in devices between them. In fact, this “self-centeredness” is symptomatic of architectural layering. Since we are dealing with how TCP works between a typical server and client at layer four, we don't worry about how data gets between them; that's the job of the Internet Protocol at layer three.

In practice, what is going on at layer three can be quite important. Considered from an abstract point of view, our server and client may be connected “directly” using TCP, but all the segments we transmit are carried across an internetwork of networks and routers between them. These networks and routers are also carrying data from many other connections and higher-layer protocols. If the internetwork becomes very busy, the speed at which segments are carried between the endpoints of our connection will be reduced, and they could even be dropped. This is called *congestion*.

Again, at the TCP level, there is no way to directly comprehend what is causing congestion or why. It is perceived simply as inefficiencies in moving data from one device to another, through the need for some segments to be retransmitted. However, even though TCP is mostly oblivious of what is happening on the internetwork, it **must** be smart enough to understand how to deal with congestion and not exacerbate it.

Recall that each segment that is transmitted is [placed on the retransmission queue with a retransmission timer](#). Now, suppose congestion dramatically increased on the internetwork, and there were no mechanisms in place to handle congestion. Segments would be delayed or dropped, which would cause them to time out and be retransmitted. This would increase the amount of traffic on the internetwork between our client and server. Furthermore, there might be thousands of other TCP connections behaving similarly. Each would keep retransmitting more and more segments, increasing congestion further, leading to a vicious circle. Performance of the entire internetwork would decrease dramatically, resulting in a condition called *congestion collapse*.

The message is clear: TCP cannot just ignore what is happening on the internetwork between its connection endpoints. To this end, TCP includes several specific algorithms that are designed to respond to congestion, or avoid it in the first place. Many of these techniques can be considered, in a way, to be methods by which a TCP connection is made less “selfish”—that is, it tries to take into account the existence of other users of the internetwork over which it operates. While no single connection by itself can solve congestion of an entire internetwork, having all devices implement these measures collectively reduces congestion due to TCP.

The first issue is that we need to know when congestion is taking place. By definition, congestion means intermediate devices—routers—are overloaded. Routers respond to overloading by dropping datagrams. When these datagrams contain TCP segments, the segments don't reach their destination, and they are therefore left unacknowledged and will eventually expire and be retransmitted. This means that when a device sends TCP segments and does not receive acknowledgments for them, it can be assumed that in most

cases, they have been dropped by intermediate devices due to congestion. By detecting the rate at which segments are sent and not acknowledged, a TCP device can infer the level of congestion on the network between itself and its TCP connection peer.

TCP Congestion Handling Mechanisms

We must then decide what to do with this information. The main TCP standard, RFC 793, includes very little information about TCP congestion handling issues. That is because early versions of TCP based solely on this standard didn't include congestion handling measures—it was problems with these early implementations that lead to the discovery that congestion was an important issue. The measures used in modern devices were developed over the years, and eventually documented in RFC 2001, *TCP Slow Start, Congestion Avoidance, Fast Retransmit, and Fast Recovery Algorithms*.

Here is a simplified description of each of the four techniques that comprise the name of this standard.

Slow Start

In the original implementation of TCP, as soon as a connection was established between two devices, they could each go “hog wild”, sending segments as fast as they liked as long as there was room in the other device's receive window. In a busy internetwork the sudden appearance of a large amount of new traffic could exacerbate any existing congestion.

To alleviate this, modern TCP devices are restrained in the rate at which they initially send segments. Each sender is at first restricted to sending only an amount of data equal to one “full-sized” segment—that is, equal to the [MSS value](#) for the connection. Each time an acknowledgment is received, the amount of data the device can send is increased by the size of another full-sized segment. Thus, the device “starts slow” in terms of how much data it can send, with the amount it sends increasing until either the full window size is reached or congestion is detected on the link. In the latter case, the congestion avoidance feature, described below, is used.

Congestion Avoidance

When potential congestion is detected on a TCP link, a device responds by throttling back the rate at which it sends segments. A special algorithm is used that allows the device to drop the rate at which segments are sent quickly when congestion occurs. The device then uses the *Slow Start* algorithm just above to gradually increase the transmission rate back up again to try to maximize throughput without congestion occurring again.

Fast Retransmit

We've already seen in [our look at TCP segment retransmission](#) that when segments are received by a device out of order (meaning, non-contiguously), the recipient will only acknowledge the ones received contiguously. The Acknowledgment Number will specify the

sequence number of the byte it expects to receive next. So, in the example given in that topic, Segment #1 and #2 were acknowledged while #4 was not, because #3 was not received.

It is possible for a TCP device to in fact respond with an acknowledgment when it receives an out-of-order segment, simply “reiterating” that it is stuck waiting for a particular byte number. So, when the client in that example receives Segment #4 and not Segment #3, it could send back an Acknowledgment saying “I am expecting the first byte of Segment #3 next”.

Now, suppose this happens over and over. The server, not realizing that Segment #3 was lost, sends Segment #5, #6 and so on. Each time one is received, the client sends back an acknowledgment specifying the first byte number of Segment #3. Eventually, the server can reasonably conclude that Segment #3 is lost, even if its retransmission timer has not expired.

The *Fast Retransmit* feature dictates that if three or more of these acknowledgments are received, all saying “I want the segment starting with byte #N”, then it's probable that the segment starting with byte #N has been lost, usually because it was dropped due to congestion. In this case, the device will immediately retransmit the missing segment without going through the normal retransmission queue process. This improves performance by eliminating delays that would suspend effective data flow on the link.

Fast Recovery

When *Fast Retransmit* is used to re-send a lost segment, the device using it performs *Congestion Avoidance*, but does not use *Slow Start* to increase the transmission rate back up again. The rationale for this is that since multiple *ACKs* were received by the sender all indicating receipt of out-of-order segments, this indicates that several segments have already been removed from the flow of segments between the two devices. For efficiency reasons, then, the transmission rate can be increased more quickly than when congestion occurs in other ways. This improves performance compared to using the regular *Congestion Avoidance* algorithm after *Fast Retransmit*.

Relationship of Congestion Handling Mechanisms

In practice, these features are all related to each other. *Slow Start* and *Congestion Avoidance* are distinct algorithms but are implemented using a single mechanism, involving the definition of a *Congestion Window* that limits the size of transmissions and whose size is increased or decreased depending on congestion levels. *Fast Retransmit* and *Fast Recovery* are implemented as changes to the mechanism that implements *Slow Start* and *Congestion Avoidance*.

I realize that this is somewhat cryptic; congestion handling is a rather complex process. If you want to learn more, RFC 2001 contains the technical details, showing how each of the algorithms is implemented in each device. I have specifically omitted those details from this topic since I feel my summary descriptions are already complicated enough, and my goal was simply to help you get a feel for how congestion is handled in TCP in general terms.



Key Concept: TCP flow control is an essential part of regulating the traffic flow between TCP devices, but takes into account only how busy the two TCP endpoints are. It is also important to take into account the possibility of *congestion* of the networks over which any TCP session is established, which can lead to inefficiency through dropped segments. To deal with congestion and avoid contributing to it unnecessarily, modern TCP implementations include a set of congestion avoidance algorithms that alter the normal operation of the sliding window system to ensure more efficient overall operation.



Summary Comparison of TCP/IP Transport Layer Protocols (UDP and TCP)

The [User Datagram Protocol \(UDP\)](#) and [Transmission Control Protocol \(TCP\)](#) are the “siblings” of the transport layer in the TCP/IP protocol suite. They perform the same role, providing an interface between applications and the data-moving capabilities of the Internet Protocol (IP), but they do it in very different ways. The two protocols thus provide choice to higher-layer protocols, allowing each to select the appropriate one depending on its needs.

I have described UDP and TCP in detail in their own sections. However, these sections take some time to read; the UDP section is several pages and the TCP section has many more! For your convenience I have included here [Table 161](#), which helps illustrate the most important basic attributes of both protocols and how they contrast with each other:

Table 161: Summary Comparison of UDP and TCP

Characteristic / Description	UDP	TCP
General Description	Simple, high-speed, low-functionality “wrapper” that interfaces applications to the network layer and does little else.	Full-featured protocol that allows applications to send data reliably without worrying about network layer issues.
Protocol Connection Setup	Connectionless; data is sent without setup.	Connection-oriented; connection must be established prior to transmission.
Data Interface To Application	Message-based; data is sent in discrete packages by the application.	Stream-based; data is sent by the application with no particular structure.
Reliability and Acknowledgments	Unreliable, best-effort delivery without acknowledgments.	Reliable delivery of messages; all data is acknowledged.
Retransmissions	Not performed. Application must detect lost data and retransmit if needed.	Delivery of all data is managed, and lost data is retransmitted automatically.
Features Provided to Manage Flow of Data	None	Flow control using sliding windows; window size adjustment heuristics; congestion avoidance algorithms.
Overhead	Very low	Low, but higher than UDP
Transmission Speed	Very high	High, but not as high as UDP
Data Quantity Suitability	Small to moderate amounts of data (up to a few hundred bytes)	Small to very large amounts of data (up to gigabytes)
Types of Applications That Use The Protocol	Applications where data delivery speed matters more than completeness, where small amounts of data are sent; or where multicast/broadcast are used.	Most protocols and applications sending data that must be received reliably, including most file and message transfer protocols.
Well-Known Applications and Protocols	Multimedia applications, DNS, BOOTP, DHCP, TFTP, SNMP, RIP, NFS (early versions)	FTP, Telnet, SMTP, DNS, HTTP, POP, NNTP, IMAP, BGP, IRC, NFS (later versions)



TCP/IP Application Layer Protocols, Services and Applications (OSI Layers 5, 6 and 7)

The [OSI Reference Model](#) is used to describe the architecture of networking protocols and technologies and to show how they relate to one another. In the chapter describing the OSI model, I mentioned that [its seven layers could be organized into two layer groupings](#): the lower layers (1 through 4) and the upper layers (5 through 7). While there are certainly other ways to divide the OSI layers, I feel this split best reflects the different roles that the layers play in a network.

The lower layers are concerned primarily with the mechanics of formatting, encoding and sending data over a network; they involve software elements but are often closely associated with networking hardware devices. In contrast, the upper layers are concerned mainly with user interaction and the implementation of software applications, protocols and services that let us actually make use of the network. These elements generally don't need to worry about details, relying on the lower layers to ensure that data gets to where it needs to go reliably.

In this chapter I describe the details of the many protocols and applications that run on the upper layers in modern networks and internetworks. The organization of this chapter is quite different than the previous one. I felt that there was benefit to explaining the technologies in each of the lower layers separately. This is possible because with a few exceptions, the dividing lines between the lower layers are fairly well-established, and this helped show how the layers differ.

The upper layers are much more difficult to separate from each other, because there are many technologies and applications that implement more than one of layers 5 through 7. Furthermore, even differentiating between these layers becomes less important near the top of the networking stack. In fact, the TCP/IP protocol suite uses an architecture that lumps all the higher layers together anyway.

For these reasons, this chapter is divided functionally and not by layer. It contains four different sections that cover distinct higher-layer protocol and application areas. The first discusses naming system, especially the TCP/IP Domain Name System. The second overviews file and resource sharing protocols, with a focus on the Network File System. The third covers network configuration and management protocols, which includes the host configuration protocols BOOTP and DHCP. The last and largest section covers end-user applications and application protocols, including general file transfer, electronic mail, Usenet, the World Wide Web, interactive protocols (such as Telnet) and administration utilities.

Name Systems and TCP/IP Name Registration and Name Resolution

Humans and computers first started dealing with each other several decades ago. The relationship between man (and woman!) and machine has been a pretty good one overall, and this is reflected in the fact that while computers were once just the province of techies, they are now *mainstream*. However, there are areas where humans and computers simply don't see eye to eye. One of these is in the way that we deal with information.

Computers work best with numbers, while most people prefer... not to work with numbers. This fundamental disconnect represented a problem for the designers of networking technology. It made sense from a technical standpoint to design addressing schemes for networks and internetworks using simple numeric identifiers, for simplicity and efficiency. Unfortunately, identifying computers using numeric addresses is cumbersome for people, and becomes more so as the number of devices on a network increases.

To solve this problem, the techies went to work, and came up with *name systems* for networks. These mechanisms allow computers to continue to use simple, efficient numeric addresses, while letting humans specify easier-to-remember names that identify them. This way, everyone is happy. Well, almost everyone I guess. These systems mean those of us studying networks have one more thing to learn. ☺

In this section I explain both the theory and practice behind networking name systems. I begin with a section that describes the motivation for name systems and the important concepts and techniques behind how they work. I then have a large section devoted to the name systems used for TCP/IP. This includes both the very important Domain Name System (DNS), as well as the older host table method that preceded it.

Name System Issues, Concepts and Techniques

Name systems can be considered in some ways the “diplomats” of the networking protocol stack. Just as a political diplomat is skilled at speaking multiple language and ensuring good communications between those who may view the world in different ways, name systems bridge the gulf between the numeric addresses that computers like to use, and the simpler names that humans prefer.

Before looking at specific name systems, I felt it made sense to discuss them generally. This will help us understand both the reasons why these systems are important, and also the concepts that underlie all name systems regardless of specific implementation. I begin this section with an overview of name systems and a discussion of why they were created. I then discuss the different main functions of a name system: the name space, name registration and name resolution. I then expand upon this functional overview, illustrating how name spaces and architectures work, the issues behind name registration and administration, and finally, name resolution techniques and the practical issues in the resolution process.

Since this is an introductory section, I have attempted to stick to general descriptions and not make too many mentions of specific name systems in the topics here. However, I like to use examples to explain concepts and for this purpose do make reference to the TCP/IP Domain Name System (DNS) at times. However, you do not need to be familiar with DNS to follow this section.

Name System Overview and Motivation

In [the introduction to this section on name systems](#) I mentioned one of several important differences between humans and computers: how we prefer to deal with information. Computers work with numbers, while very few of us humans like to do so. This distinction becomes particularly important when we look at how identifiers or addresses are assigned to network devices.

Symbolic Names for Addressing

To a computer, there is no problem with simply assigning a number to each device on the network and using those numbers to move information around. Your computer would be perfectly happy if you assigned a number like 341,481,178,295 to it and all the other machines on your network, and then issued commands such as “send this file to machine 56,712,489,901”. However, most humans don't want to use a network in this manner. These long cryptic numbers don't mean anything to them. They want to tell their machine “send this file to Joe's computer”; “print this on the color laser in the Sales department”, or “check CNN's Web site to see what the latest headlines are”.

It is this disconnect that led to the development of *name systems*. These technologies allow computers on a network to be given both a conventional numeric address and also a more “user-friendly” human-readable name. This name is comprised of letters, numbers and other special symbols, and is sometimes called a *symbolic name*; it can be used as an

alternative form of addressing for devices. The name system takes care of the functions necessary to manage this system, including ensuring that names are unique, translating from names to numbers, and managing the list of names and numbers.

A Paradox: Name Systems Are Both Essential and Unnecessary?

What's interesting about name systems is that they are extremely important to networks... but at the same time, they often aren't strictly necessary for a network to operate. This seeming paradox is due again to the difference between humans and computers. Computers only need the numeric addressing scheme, not the "human names" assigned to them. So the computers and the network can still work—but it will be much harder for us people to use them!

An example of this can most readily be seen when a problem disables the operation of a part of the [Domain Name System \(DNS\)](#) used to provide naming services on the Internet. Technically, DNS isn't needed to use the Internet, because all communications use IP addresses. This means that even though you might normally access CNN's web site at "www.cnn.com", you could instead just use the IP address 64.236.16.20 if DNS wasn't working.

The problem is that prior to reading this, you probably had no idea what the IP address of CNN's Web site was, and that's true of almost everyone else who uses their site as well. Also, you might want to check not just CNN's Web site, but perhaps one, two or twenty other news sites. It would be difficult to remember the numbers for even a small percentage of the thousands of different Web sites on the Internet, so each time you wanted to access a resource you'd have to manually look up its address, as shown in [Figure 229](#).

Factors That Determine the Necessity of a Name System

It's much easier to remember the names of resources; when a name system is implemented, you just enter the name of a device and the name system converts it to an address, as shown in [Figure 230](#). This is why name systems are so important, even if they aren't needed by the networking technologies themselves. (In fact, the reliance on name systems like DNS is so significant that many people don't even realize they can enter IP addresses into their Web browsers!)

More generally, the importance of a name system depends greatly on the characteristics of the network upon which it is used. The three main issues in determining the need for a name system are:

- ☉ **Network Size:** If you have a really small network with only a handful of computers, having human users remember the numeric addresses for these machines is at least feasible, if not ideal. For example, a small home network with two or three machines doesn't really *need* a name system, in theory. If you have thousands or millions of devices, however, the name system becomes essential.
- ☉ **Address Size and Complexity:** The more complex the numeric addressing scheme, or the larger the numbers used, the more difficult it is for humans to remember the numbers.



Human User

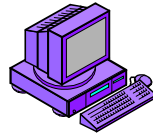

Client

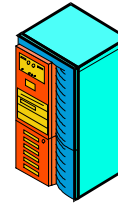

Server

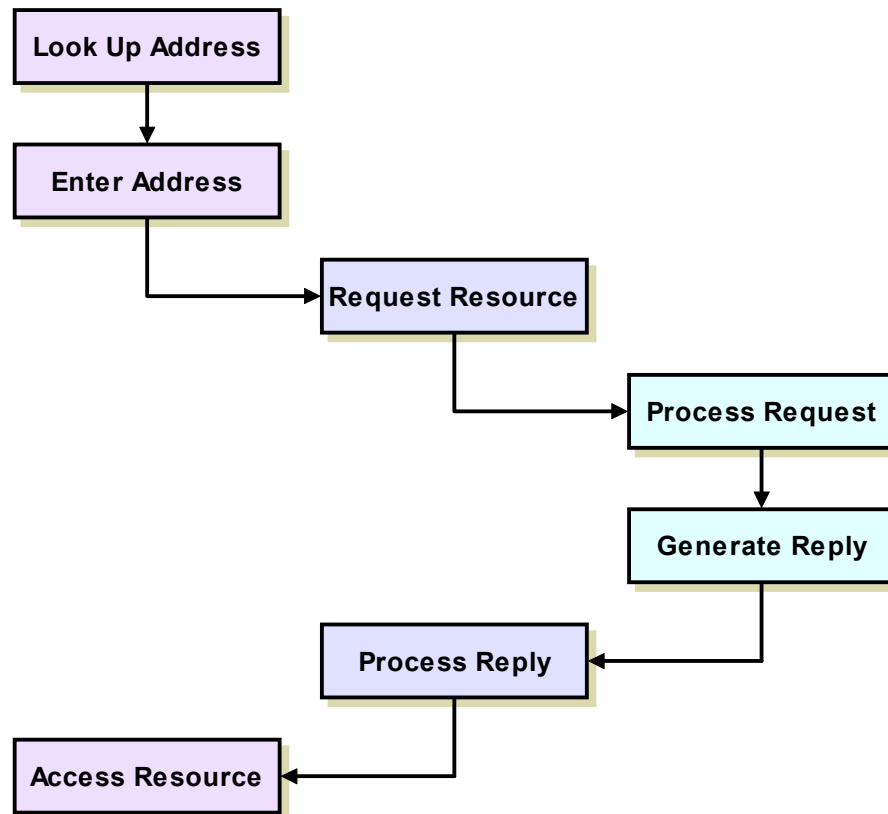

Figure 229: Internetwork Access Without A Name System

When there is no name system, a user must know the address of any device he or she wishes to access on the internetwork. Since most of us have limited memories for numbers, this means each access must be preceded by an inefficient, tedious manual address look-up.

- ☉ **User Base Size and Skill:** In the early days of networks, a small number of highly-skilled and well-trained engineers used them, and these people sometimes just memorized the numbers of the machines they worked with every day. In modern networks with thousands or millions of “lay” users, expecting the average person to remember device numbers is not reasonable.

Looking at these issues, we can see that the trends in today’s networks are all in the direction of increasing the importance of name systems. Our networks, both private and public, are growing larger, and we have more people using them, including more people without a technical background. We are also increasingly moving from small addresses to

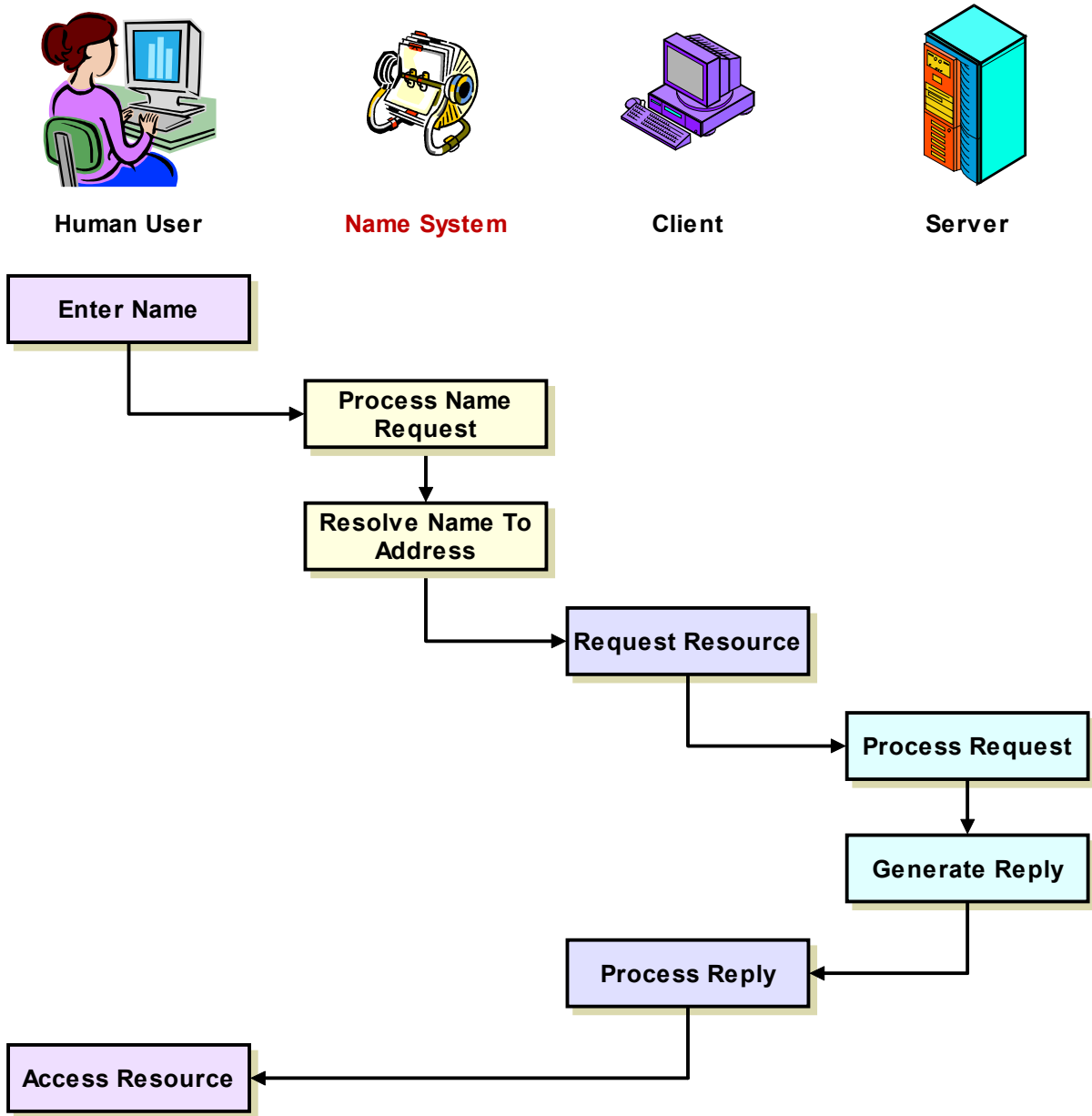

Figure 230: Internetwork Access With A Name System

When an internetwork is equipped with a name system, the user no longer needs to know the address of a device to access it. He or she enters the name and the name system converts it into an address automatically, like a computerized “rolodex”, as I have shown here. ☺ The name system then passes the address to the client software which uses that address to access the requested resource as if the user had entered it directly.

larger ones. The best example of this is [the upcoming change to the Internet Protocol](#). While DNS is important for the 32-bit addresses used in IP version 4, it's even *more* important for dealing with [the enormous 128-bit addresses of IP version 6](#).



Key Concept: Networking name systems are important because they allow devices to be assigned efficient numeric addresses, while still enabling humans to access them using names that are easier to remember. Name systems become more important as you increase the size of the network, the address or the user base. They are also more essential when the user base is limited in skill or experience.

Name System Functions: Name Space, Name Registration and Name Resolution

While the difference between numeric addresses and symbolic names is very significant to the users of network devices, it's important to remember that both numbers and names really serve the same basic purpose: *device identification*. Even when we use a name system to make devices easier to access, the computers themselves will still normally need to use the underlying numeric identifier. In essence, then, every device will end up with (at least) two identifiers: a number **and** a name.

The fact that devices end up with multiple identifiers is what allows both people and their machines to use the method of identification they prefer. However, it means that there must be ways of managing the assignment of names to devices, and of converting between them. A name system therefore involves more than just slapping names on computers. It must be, in fact, a complete **system** that allows names to be used by the humans while numbers continue to be used by the devices.

Overview of Basic Name System Functions

At the highest level, I consider a name system's jobs as encompassing these three basic functions:

- ① **Name Space:** The name system defines a *name space* for the networking system upon which it runs. The name space, also sometimes called a *name architecture*, describes the rules for how names are structured and used. It also defines how the name of one device is related to the names of other devices in the system, and how to ensure that no invalid names are given that would cause problems with the system as a whole.
- ② **Name Registration:** To implement the name system, a name must be assigned to each device on the network. Like any addressing system, a name system cannot work properly unless every name on the system is unique; we need some way of managing how the names are assigned so the result is sensible. The process of linking specific names to particular devices is usually called *name registration*.
- ③ **Name Resolution:** As I mentioned above, even though humans like symbolic names, computers usually have little use for them. It is necessary to define a mechanism by which a device's symbolic name can be translated into its numeric address. This process is usually called *name resolution*.

Relationships Between Name System Functions

The name space is more of a “descriptive” function; it is a definition of how names work in the system. Name registration and resolution are more “active” functions, with each name system including one or more specific procedures for how these jobs are carried out. Name registration and resolution are in some ways complements of each other, so certain registration techniques are most often associated with particular resolution methods. In turn, the types of registration and resolution methods that are possible depends on the name space and in particular its architecture. These relationships are shown in simplified form in [Figure 231](#).

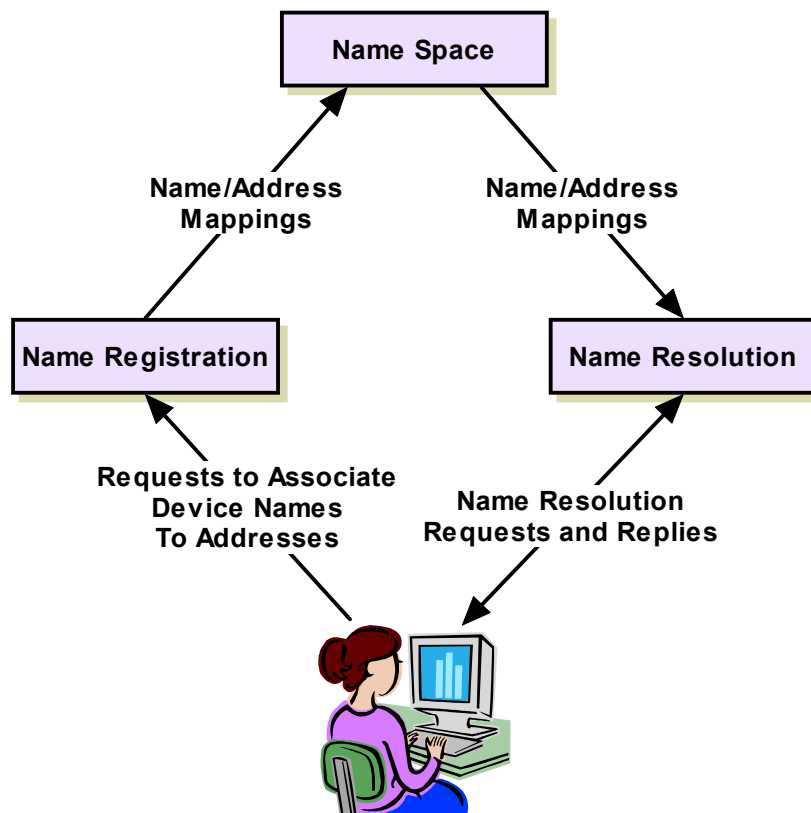

Figure 231: Name System Functions

This diagram shows the relationships between the three main functions of a name system. The *name space* defines the structure of the name system and the rules for creating names. The name space is used as the basis for the *name registration* method, which defines the mappings between names and addresses. When a user wants to access a device by name, a name resolution method is used to consult the name space, determine what address is associated with a name, and then convert the name to an address.

The processes of registration and resolution can be either quite plain or fairly complicated, depending on the type of name system used. Simple name systems are largely manual in operation, easy to understand and best used in smaller networks. Larger, more complex networks and internetworks require more sophisticated methods of registration and resolution, which work with less need for administrator intervention and *scale* better as new machines are added to the network.

I should also point out that while I consider name registration and name resolution as “functions” at the highest level, they are probably better thought of as **sets** of functions. Name registration is necessarily tied into issues such as name system administration and management, and understanding resolution requires that we look at a number of important implementation issues in the areas of efficiency and reliability. The next few topics expand on this overview by considering each of these three functions in more detail.



Key Concept: A name system consists of three theoretical high-level functions: the *name space*, which describes how names are created and organized; the *name registration* technique, which is used to set up relationships between names and addresses; and the *name resolution* method, which is responsible for translating names to addresses.

Name Spaces and Name Architectures (Flat and Hierarchical)

The main idea of a name system is to provide a way to identify devices using symbolic names. Like any identification mechanism, before we can use the system we must define the way that identification will be performed. Numeric addressing schemes (like IP addresses) have rules for how addresses are created, and assign addresses to each device from their *address space*. In a similar way, devices in a name system are given names from the system's *name space*.

Name Space Functions

Of the three main functional components of a name system, the name space is the most abstract. It is also the most fundamental part of the system, since it actually describes how the names are created. There are several aspects to what the name space defines in a name system:

- ☉ **Name Size and Maximum Number of Names:** The name space specifies the number of characters (symbols) that comprise names. In so doing, it also defines the maximum number of names that can appear in the system.
- ☉ **Name Rules and Syntax:** The name space specifies what characters or symbols are allowed in a name. This is used to allow legal names to be chosen for all devices while avoiding illegal names.
- ☉ **Name Architecture and Semantics:** Each name space uses a specific *architecture* or *structure*, which describes how names are constructed and interpreted.

Name Architectures

The concepts of name size and name syntax are relatively straight-forward. The last item, *name architecture*, is probably the most important differentiating characteristic of name systems. For this reason, name spaces are sometimes even **called** name architectures. The architecture of the name space determines whether names are assigned and used as

a simple unstructured set of symbols, or whether they have a more complex internal structure. In the latter case, the name space also must define how elements of a particular name are related to each other.

Theoretically, many different name architectures are possible. In practice, most fall into one of two categories: flat and hierarchical architectures.

Flat Name Architecture (Flat Name Space)

Names are assigned as a sequence of symbols that are interpreted as a single, whole label without any internal structure. There is no clear relationship between any name and any other name.

An example of this sort of architecture would be a name system where computers are given unstructured names like “Engineering Workstation 1” or “Joanne’s PC”, as shown in the example in [Figure 232](#).

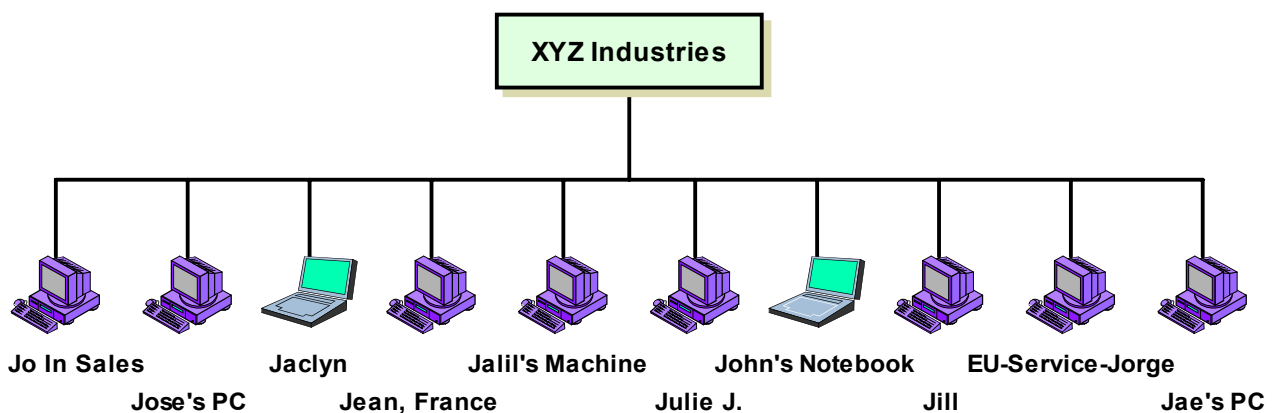

Figure 232: Flat Name Architecture (Flat Name Space)

This diagram shows an example of a flat name architecture. There is no structure that organizes the names or dictates how they must be constructed. Logically, each device is a peer of each of the others.

Hierarchical Name Architecture (Hierarchical or Structured Name Space)

In this architecture, while names consist of a sequence of symbols, these symbols are assigned using a specific and clear structure. The name consists of discrete elements that are related to each other usually using hierarchical “parent/child” semantics. There are many naming architectures in various contexts that use this type of hierarchical structure; for example, consider how a large company might set up an organization chart and name the executives and officers in the organization. One hypothetical example of a hierarchical name architecture is illustrated in [Figure 233](#).

The best-known real world example of a hierarchical name space is the [name space of the TCP/IP Domain Name System](#), which uses text labels separated by periods (“dots”) to form an internal structure. All the names in the system are organized into a structure, and a

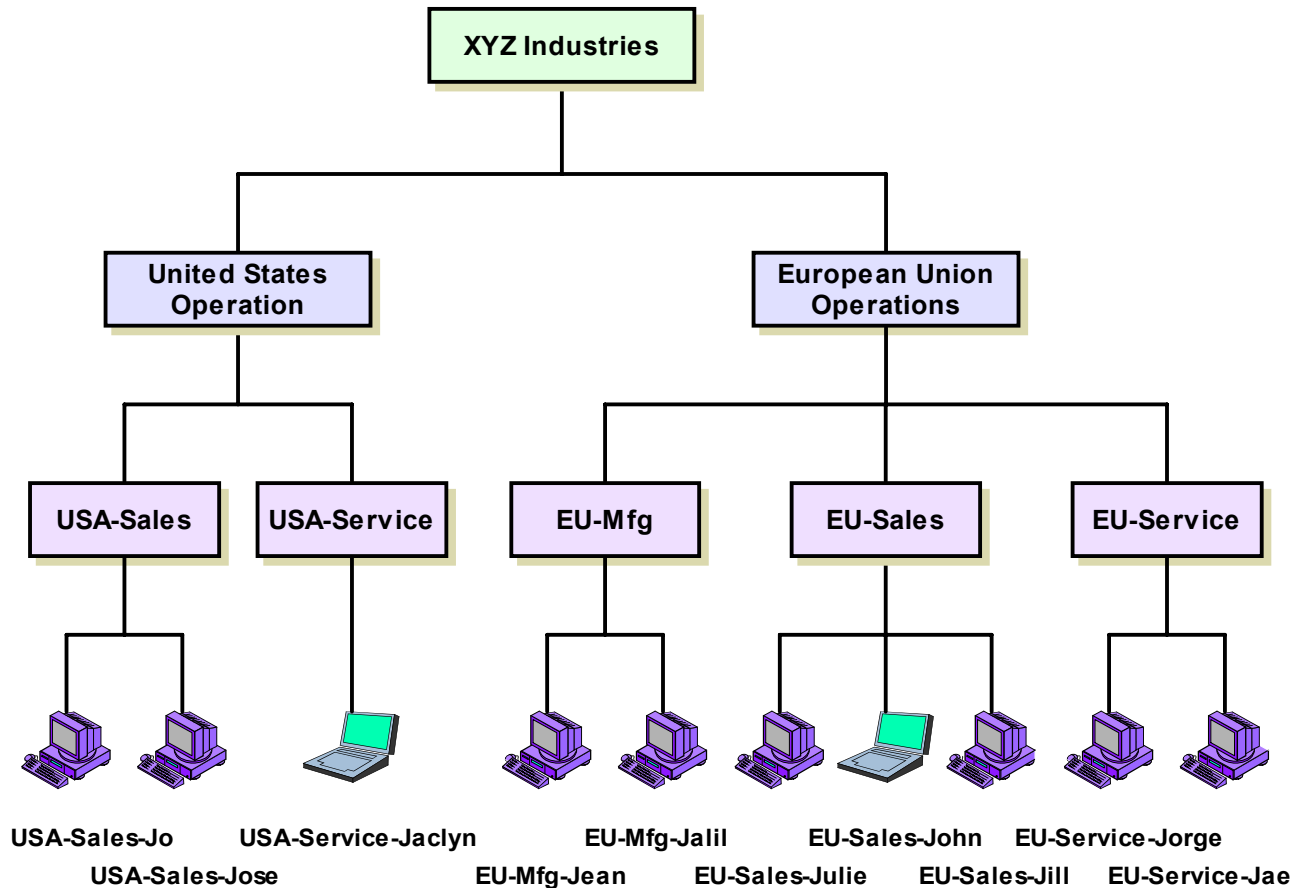

Figure 233: Hierarchical Name Architecture (Structured Name Space)

This diagram contains the same devices as [Figure 232](#), but they have been arranged using a hierarchical, structured name architecture. In this case, the organization has chosen to structure its device names first by facility location, and then by department. Each name starts with something like “USA-Service-” or “EU-Mfg-”.

This provides immediate benefits by providing local control over device naming without risk of conflicts. If someone named John were hired into the USA sales force, his machine could be named “US-Sales-John” without conflicting with the machine owned by John of the European sales force (“EU-Sales-John”). The structure also makes it easier to know immediately where a device can be found within the organization.

particular device's place in the structure can be determined by looking at its name. For example, “www.tcpipguide.com” refers to the World Wide Web server for The TCP/IP Guide, which is named under the umbrella of “COMmercial” companies.

Comparing Name Architectures

As we will see in the next two topics, the architecture of the name space is intimately related to how names are registered and managed, and ultimately, how they are resolved as well. A flat name space requires a central authority of some sort to assign names to all devices in the system to ensure uniqueness. A hierarchical name architecture is ideally suited to a more distributed registration scheme that allows many authorities to share in the registration and administrative process.

All of this means that the advantages and disadvantages of each of these architectures are not a great mystery. Flat name spaces have the advantage of simplicity and the ability to create short and easily remembered names, as shown in [Figure 232](#). However, they do not scale well to name systems containing hundreds or thousands of machines, due to the difficulties in ensuring each name is unique. For example, what happens if there are four people named John who all try to name their computers “John’s PC”? Another issue is the overhead needed to centrally manage these names.

In contrast, hierarchical name spaces are more sophisticated and flexible, because they allow names to be assigned using a logical structure. We can name our machines using a hierarchy that reflects our organization’s structure, for example, and give authority to different parts of the organization to manage parts of the name space. As long as each department is named uniquely and that unique department name is part of each machine name, we don’t need to worry about each assigned name being unique across the entire organization, only within the department. Thus we can have four different machines named with their department name and “John”, as [Figure 233](#) demonstrates. The price of this flexibility is the need for longer names and more complexity in name registration and resolution.



Key Concept: The two most common types of name architecture are the *flat name space* and the *hierarchical name space*. Names in a flat name space are all peers with no relationship; in a hierarchical architecture, a multi-level structure is used to organize names in a specific way. The flat system is simpler and satisfactory for small networks, while the hierarchical name space is more flexible and powerful, and better-suited to larger networks and internetworks.

Name Registration Methods, Administration and Authorities

It seems obvious that for our name system to be implemented, we need some method of assigning names to each of the devices that will use the system. Just as a name system has a name space that is comparable to an addressing system's address space, it also must implement a set of rules and procedures for assigning names, just as an addressing system assigns addresses. This is called *name registration*.

Name Registration Functions

In general, name registration encompasses the following concepts and tasks:

- **Name Assignment and Guaranteeing Uniqueness:** The core task of the name registration process is of course assigning names to devices. Like all identification schemes, a key requirement of name registration is ensuring that each name is unique. Duplicated names cause ambiguity and make consistent name resolution impossible.

-
- ④ **Central Registration Authority Designation:** Ensuring uniqueness of names requires that there be someone “in charge” of the name assignment process. This *central registration authority* may be a single individual that maintains a file containing names, or an organization that is responsible for the overall name registration process. The authority is also charged with resolving problems and conflicts that may arise in registrations.
 - ④ **Registration Authority Delegation:** In smaller name systems, the central registration authority may be responsible for the actual registration process for all devices. In larger, hierarchical name systems, having this process centralized is impractical. Instead, the central registration authority will divide the name space and *delegate* authority for registering names in different parts of it to subordinate organizations. This requires a delegation policy to be developed and implemented.
 - ④ **Defining Hierarchical Structure:** When a hierarchical name space is used, the central authority is responsible for defining how the structure will look. This in turn dictates how names can be registered in different parts of the hierarchy, and of course, also impacts how authority is delegated.

Impact of Name Space Architecture on Name Registration

The complexity of the name registration process depends to a great extent on the size and complexity of the name system as a whole, and in particular [the architecture of the name space](#). In a simple name system using a flat name space, registration is usually accomplished using a single authority. There is no structure, of course, and usually no delegation of authority, so there isn't much to registration.

For hierarchical name systems, name registration is tied tightly to the hierarchy used for names. The central authority defines the structure of the hierarchy, and decides how the hierarchy is to be *partitioned* into subsets that can be independently administered by other authorities. Those authorities may in turn delegate subsets of their name spaces as well, creating a flexible and extensible system.

This ability to delegate authority for name registration is one of the most powerful benefits of a hierarchical name space. For example, in the [TCP/IP Domain Name System](#), a central authority is responsible for name registration as a whole; it is in charge of deciding what top-level domains, such as “.com”, “.edu”, “.info” and “.uk” are allowed to exist. Authority for managing each of these subsets of the worldwide hierarchy is then delegated to other organizations. These organizations continue the process of dividing the hierarchy as they see fit. Eventually each organization is able to decide how it will name its own internal systems independently; for example, IBM can register names in any way it sees fit within the “ibm.com” name.

Name Registration Methods

There are several common methods by which the actual process of registration is carried out. Each of these has its strengths and weaknesses, and again, some are better-suited to flat name spaces and some to hierarchical ones.

Table Name Registration

In this technique, name assignments are maintained in a table by an administrator. When names need to be added, deleted or changed the table is edited.

This technique is usually associated with small, flat name space name systems, and has the same benefits and drawbacks as flat architecture in general: it is simple and easy to implement, but doesn't scale well to larger systems. With a dozen machines, having someone edit name registration tables is practical; with thousands of machines it is not. It is also not conducive to a hierarchical system where there are multiple authorities, because the table needs to be kept in one place.

In larger internetworks, tables may be used as an adjunct to one of the more sophisticated techniques below.

Broadcast Name Registration

This is a “trial and error” technique; a device that wants to use a particular name sends out a message to all other devices on the network asking to see if anyone else is already using it. If so, it chooses a different name. If not, the name is considered registered and can then be used.

This technique is more sophisticated than using tables, but is still limited to use in relatively small systems. It is not practical to attempt to broadcast to thousands of systems, and this method could not be used over the Internet, since there is no way to broadcast to every device on an internetwork.

Database Registration

A database of name assignments is maintained. To register a name, a request must be made to have the name assignment added to the database. If the authority for the name system is entirely centralized, the database will be centralized and maintained by that authority. If authority for parts of the hierarchy is delegated, then a *distributed database* is used for registration, with each authority maintaining the part of the database describing their section of the hierarchy.

This is the most sophisticated technique, and one normally associated with hierarchical name systems like DNS. It has several benefits, including flexibility, reliability and distribution of maintenance effort; its main drawback is complexity.



Key Concept: *Name registration* is the process by which names are linked to addresses in a name system. It encompasses activities such as central registry authority designation and delegation, and name space structure management. The most common methods of name registration, in order of both increasing capability and complexity, are manual table maintenance, broadcast registration and database registration.

We have just seen that the choice of name space and architecture immediately has an important impact on how name registration is done. [The next topic](#) will show how name resolution is closely related to name registration and architecture as well.

Name Resolution Techniques and Functional Elements of A Name Resolution System

[As we discussed earlier in this section](#), using a name system creates two “parallel” identification systems for computers: the numbers used by machines and the names used by people. The job of the name system is to integrate these two schemes. [Name registration](#) allows humans to specify which machines use which names. This is only half the process, however; we also need a way for machines to take a name given to them by a human and translate it into the “real” address it can actually use for communication. This is called *name resolution*.

Name resolution, also sometimes called *name translation*, *mapping* or *binding*, is the most well-known aspect of name systems, because it is where most of the “heavy lifting” of a name system occurs. The name space is generally set up once, and name registration occurs infrequently: only when names must be created or changed. In contrast, every user of a name system instructs the machines he or she uses to perform name resolution, hundreds or even thousands of times a day.

Name Resolution Methods

There are several different techniques that can be use for name resolution. How this function is implemented depends a great deal on the other two name system functions, name space and name registration. As you might imagine, a simple name system with a simple name registration method will most often use a simple resolution method as well. Complex hierarchical systems with distributed databases require more sophistication in how names are resolved.

There are three common name resolution methods.

Table Name Resolution

The table used for table-based name registration is consulted by a device when resolution needs to be performed. The table tells the device how to transform the name of the machine it needs to contact into an address.

This technique obviously corresponds to table name registration; it is the simplest and least capable of the three methods. Table name resolution is suitable for standalone use only in very small name systems, but can be a supplement to other methods as well.

Broadcast Name Resolution

When a device needs to resolve a name, it broadcasts a query that says something to this effect: “I need to send to the device named 'X', who is that?” The device whose name is 'X' responds back saying “I'm 'X' and my numeric address is 'N'”.

This is the complement of broadcast name registration, of course. It too can only be used in simple systems where every device can hear a broadcast. The use of broadcasts also makes it wasteful of network bandwidth.

Client/Server Name Resolution

Servers are programmed with software that allows them to respond to name resolution requests sent by clients. These servers take the name in the request, look up the associated numeric identifier in a database, and send it back in a response.

This technique is, of course, generally used in conjunction with database name registration. It is the most complex of name resolution methods, but is also the most efficient, and the only one that can really work properly on a large, distributed hierarchical name system.

Client/Server Resolution Functional Elements

The last of these three methods is the one used for most large, modern name systems. The client/server method of request/reply resolution is similar to how many other protocols function. One thing that is unique about name resolution, however, is that name resolution isn't often invoked directly by the client. It's rare, for example, for a human user to say "please resolve the following name". We also certainly wouldn't want a user to have to manually resolve a name to an address each time they wished to contact a device, as this would be cumbersome.

Instead, the system is automated by having software accept machine names input by users. The software resolves the name by passing it to a *name resolver* software component. The resolver acts as the client in the name resolution process. It contacts a *name server*, which responds to the request. The name resolver and name server constitute the two main functional elements in name resolution.

In a distributed database for a hierarchical name system, multiple requests may be required, since name servers will contain only information for certain machines and not others. Resolvers follow a special procedure to "travel" the hierarchy until they find the server that has the information they want. Again, [TCP/IP's Domain Name System \(DNS\) name resolution](#) is the best example of this method.



Key Concept: *Name resolution* is arguably the most important of the main functional elements of a name system, because it is the part of the system that actually converts names into addresses. The two main components of name resolution are name resolvers, which act as clients in the resolution process, and name servers. The three main name resolution methods—table-based, broadcast and client/server—correspond closely to the table, broadcast and database methods of name registration.

Efficiency, Reliability and Other Name Resolution Issues and Features

In [the preceding topic](#) I described the primary function of name resolution: allowing humans to identify devices using names, then converting these names into numbers so that computers can use the numbers instead. This basic task is conceptually quite simple, but it can become quite complex in implementation. The reason for this is the key characteristic that makes name resolution so different from the other tasks performed by a name system: the frequency with which it is done.

Name registration is seldom done, but name resolution is done very often. If you consider a large internetwork with thousands of users running various applications, millions of names must be resolved every day. Now, consider something like the Internet, which must process billions of client/server requests and replies daily! Ensuring that such systems work requires that we do more than just implement a resolution process; we must add facilities to ensure that resolution is done as effectively as possible.

Efficiency Considerations

The first major concern with name resolution is *efficiency*. Name resolution uses up system resources, especially with resolution techniques that require requests and replies to be sent. This means we want to minimize the number of times resolution is performed, if at all possible. Now, consider that many people will frequently access the same machines over and over again. For example, if you go to a Web site called “www.thisisaside.com” for the first time, your system will need to resolve that name. After the home page for that site loads, if you click a link to another page on that site, the page will also be found at that same name: “www.thisisaside.com”. It would be wasteful to then have to resolve the name a second time.

To avoid this, name systems almost always include some sort of *caching* capability, which allows devices to remember recent name resolutions and retain the mapping from name to address for a period of time. Whenever a name needs to be resolved, the cache is first checked before going through the formal process of resolution. The use of caching eliminates the vast majority of actual name resolution requests that would otherwise be required.

The drawback of caching is that it requires some system resources of its own, and that it adds complexity to the system. One issue is deciding how long to retain data in the cache; if we keep it too short a time, we generate extra unnecessary resolution requests; keep it too long, and we risk having the mapping become “stale” if the name assignment for the machine changes. These are issues that a sophisticated name system must deal with. A typical solution is to allow each name registration to specify how long information about that name-to-address link may be cached.

Reliability Considerations

The main concern with name resolution after efficiency is *reliability*. As I said earlier in the section, having a name system isn't strictly necessary for the computers, but it's very important for the users, especially on a large network like the Internet. While having a single central place that maintains all information about a name system may make administration simpler, it creates a dangerous “single point of failure”. If anything happens to the device storing the information, the entire name system fails.

Modern name systems employ redundancies to prevent having the entire system rely on any particular device for resolution. A typical approach in a client/server system is to have multiple servers in different locations (or attached to different networks) that can respond to name resolution requests.



Key Concept: Since name resolution is the part of a name system that is used most often, it is here that we must pay careful attention to implementation issues. The two most important ones are *efficiency* and *reliability*. Efficiency is essential due to the many thousands or millions of resolutions performed every day on a large system; reliability is a consideration because users of the name system quickly come to rely on it and we must make sure it is robust.

Other Considerations

An optional feature in some name resolution systems is *load balancing*. When properly implemented, load balancing allows a single name to map to more than one underlying address. This allows requests sent to a particular “virtual” device to actually be directed to a number of different actual physical devices, spreading the load over multiple machines. A common use of this feature is for very popular, heavily-trafficked Web sites.

Finally, while name resolution is obviously designed to allow names to be mapped into addresses, there are cases where we may wish to go in the other direction: given a numeric address, find the name that goes with it. This process, called *reverse resolution*, is analogous to having a phone number and trying to find the name of the person or company to which it belongs. Just as we can't easily find the name matching a phone number using a conventional phone book (we'd have to scan every page looking for the number), reverse resolution requires special support on the part of the name system. This is especially true if the name system data is distributed over many servers.



TCP/IP Name Systems: Host Tables and Domain Name System (DNS)

The TCP/IP protocol suite is the most widely used in networking today. TCP/IP has become sufficiently popular that many people—even non-geeks!—are fairly comfortable working with its numeric identifiers ([IP addresses](#)). Even so, it's a lot easier to work with names than numbers, and it's certainly easier to remember them. We can consider also that name systems become more important when used on larger networks than smaller ones, and that TCP/IP is used to implement the Internet, the world's largest internetwork. Having a good name system is vital to the operation of the Internet, and thus, has become an important element of TCP/IP as a whole.

In this section I describe the name systems used in TCP/IP. I begin with an overview of device naming in TCP/IP, including a discussion of the history of how device naming began. I then describe the two different name systems that have been used in TCP/IP: the simple host table name system, and the modern Domain Name System (DNS). Far more detail is included on the latter than the former, since DNS is both much more complex than host tables, and also more widely used in today's networks.



Background Information: This section assumes that you are already familiar with the [general concepts and issues of name systems explained in the preceding section](#). Reference is made to descriptions of name system components and methods where appropriate.

Overview and History of TCP/IP Host Names and Name Systems

In the section that introduces name systems and describes the concepts behind them, I described an interesting paradox. Even though name systems aren't strictly necessary for the functioning of a networking system, they make using a network so much easier for people that they are considered an essential part of most networks. I think no better evidence of this can be found than the history of name system development in TCP/IP.

Early Use of Host Names on the ARPAnet

In fact, the history of name systems in the TCP/IP protocol suite actually goes back well before TCP and IP were themselves even created! In the late 1960s and early 1970s, when the predecessor of the Internet (the *ARPAnet*) was being developed, it used older networking protocols that served the same function that TCP and IP do today. The ARPAnet was very small by today's standard, containing at first only a few machines, called *hosts* just as TCP/IP machines often are today. The addressing scheme was also very simple: just the combination of an IMP (computer) number and a port number for each host.

With only a handful of machines names it was easy to memorize addresses, but as the ARPAnet grew to several dozen machines this became untenable. As early as 1971, it was apparent to the engineers designing the ARPAnet that symbolic names were much easier for everyone to work with than numeric addresses. They began to assign simple host names to each of the devices on the network. Each site managed its own *host table* that listed the mappings of names to addresses.

The First ARPAnet Name System: Host Name Lists

Naturally, the ARPAnet engineers immediately recognized the dangers of having each site maintain a list of possibly inconsistent host names. Since the internetwork was just a small "club" at this point, they used the RFC process itself to document standard host name to address mappings. RFC 226, *Standardization Of Host Mnemonics*, is the first RFC I could find showing how host names were assigned. It was published on September 20, 1971.

This initial name system was about as manual as a system could be. As additions and changes were made to the network, the list of host names was updated in a new RFC, leading to a series of RFCs being published in the 1970s. Each host administrator still maintained his or her own host table, which was updated when a new RFC was published. During this time, the structure of host names was still under discussion and changes were made to just about every aspect of the name system as new ideas were explored and refined.

This worked fine while the ARPAnet was very small, but had many problems. One was that it was extremely slow in responding to network modifications; additions or changes would only be entered into device tables after a new list was published. Even with the centralized list, there were also still potential consistency issues, if a site manager forgot to update a file or made a typographical error. These were in addition to the usual limitations of a host-table-based name system.

Storing Host Names in a Host Table File

The first improvement was to make the list of host name assignments a standard “master” text file that would be centrally managed and could be downloaded using network protocols like FTP. The file was maintained at the Network Information Center (NIC) at Stanford University. The process for defining and using this file was described in RFCs 606 and 608, both entitled *Host Names On-line*, published in December 1973 and January 1974 respectively. These documents also formally specified the syntax for the [TCP/IP host table name system](#).

The use of a centrally-managed host table continued through the 1970s. When TCP/IP was developed the system was maintained, and mappings made between host names and 32-bit IP addresses. RFC 810, *DoD Internet Host Table Specification*, shows how host tables were defined for use with IP addresses. It was published in 1982.

Outgrowing the Host Table Name System and the Transition to DNS

It was at around this same time that continued growth of the ARPAnet/Internet made it apparent that the simple host table name system would eventually become unmanageable. With at first dozens and then soon hundreds and thousands of new hosts connecting to the internetwork, a single text file maintained in a central location just wasn't up to the task, [for a variety of reasons](#).

The idea of moving to a hierarchical name system based on the concept of *domains* was first introduced in 1981 in RFC 799, *Internet Name Domains*. Considerable discussion and development of this concept occurred in the early 1980s, and by 1983 a plan was put in place to migrate from the flat host table name system to the new *Domain Name System (DNS)*. The detailed history of the development of this name system is continued in [the overview section on DNS](#).



TCP/IP Host Table Name System

The pioneers of the modern Internet made the first name system for the suite when they created simple files containing the names and addresses of the machines in the early ARPAnet. This system was so simple that it originally wasn't even formally specified as a "name system" per se. Since the files contained names for network hosts, the process for relating names to addresses was simply called the "host name" mechanism. Later, these files were called *host tables*, and for this reason I call this technology the TCP/IP *host table name system*.

As a system, it is extremely simple, since it consists of nothing more than a text file maintained on each machine on the network. This file is normally called "/etc/hosts" on a UNIX system, or *HOSTS* on a Windows system (usually residing in the main Windows directory). The file usually begins with some comment lines and then lists pairs of IP addresses and host names. A very simplified example (using the modern table structure, which is slightly different than the original host table format) is shown in [Table 162](#).

Table 162: Example TCP/IP Host Table

```
# Host Database
# This file should contain the addresses and aliases
# for local hosts that share this file.
#
# Each line should take the form:
# <address>           <host name>
#
127.0.0.1             localhost
209.68.14.80         www.pcguides.com
216.92.177.143      www.desktopscenes.com
198.175.98.64       ftp.intel.com
```

Host Table Name Space

The name space and architecture for this system is theoretically flat, with each name being able to take any form without any real structure. Despite this, certain rules were eventually put in place regarding how names should be created, for consistency. As we will see later in this topic, it's also possible to use host tables to support the implementation of a hierarchical name space, which would obviously mean the names would have to be created using that name space's structural rules.

Host Table Name Resolution

Name resolution in this system is very simple. Each device reads the host table into memory when it starts up. Users of the system can make reference to the names in that host table in their invocation of various applications, by using a name instead of a numeric IP address. When the software detects a name has been used in this manner, it refers the

name to the internal resolver routine in the device, which looks up the name in the host table in memory and returns its address. There is no need for any transmissions or servers to be contacted; resolution is entirely local.

Host Table Name Registration

Now, here is the part where I am supposed to say that name registration in the host table name system is simple as well, right? Well, yes and no. From a purely technical standpoint it certainly is: a name is “registered” on a particular device when the name and corresponding IP address is entered into the device's host table, and that's it.

However, name registration is much more complicated from an administrative standpoint, and this is in fact where we find the major weakness of using host tables. Each network device maintains its own host table independent of the others, usually stored as a file on its local hard disk. This is in contrast to [database registration systems](#) where the data is centrally stored and managed. This leads to two very important concerns:

- ① **Consistency:** Since every device has its own host table, how do we ensure that information is consistent between all the tables on the different devices?
- ② **Modifications:** How do we ensure that information about new device mappings, or changes to existing ones, is propagated to all devices?

The original mechanism for this was simply [hand-editing](#), with administrators consulting updated published lists of device names. This was a very inefficient method that was prone to error and slow to acknowledge changes to the network. The revised system used a centrally-managed “master” file that was downloaded by all sites on a regular basis. Name registration in this method required that the name/address mapping be submitted to the authority managing the central file, the Network Information Center (NIC).

Weaknesses of the Host Table Name System

The use of a centralized master file for name registration certainly worked better than using the equivalent of “inter-office memos” to publish host name lists, but was itself only practical in the early days of TCP/IP. As the internetwork grew larger, the weaknesses of the host table system grew:

- ① **Central Administration Overload:** The changes to the central file became more frequent, increasing the administrative load on the individual managing the “master” file to the point where changes were being made many times per day. As the Internet continued to grow, it would eventually have been impossible for a human being to enter the changes as fast as they were being submitted.
- ② **Growth In Size Of the Master File:** Every host needed a line in the master file. When the Internet grew to be thousands and eventually millions of devices, the file size would have become excessive.

-
- 🕒 **Excessive Bandwidth Use:** Since the file was changing so often, this also meant that all the devices on the network had to keep downloading this master file repeatedly to stay current. At the same time, the file was also growing in size as just mentioned. The combination of many downloads of a large file meant large amounts of network bandwidth were being consumed on something that is, in essence, an overhead activity.
 - 🕒 **Flat Namespace Problems:** The lack of a hierarchical name space led to conflicts when users chose identical names for their devices, and this further increased the workload on the central administrator. These issues were ameliorated in part by using naming conventions, such as using a prefix with a location before each individual machine name, but this was not an ideal solution.

All of these are reasons why the designers of the Internet eventually moved away from using host tables for the entire Internet to the more capable [Domain Name System \(DNS\)](#).



Key Concept: The *host table name system* was the original mechanism used for implementing names on the early Internet. It consists simply of a set of tables containing mappings between names and addresses maintained on each machine in the internetwork. When a name needs to be resolved the table is consulted to determine the appropriate address. This system is extremely simple, but not very capable, and not well-suited to a large global Internet, which is why it was eventually abandoned in favor of DNS.

Use of the Host Table Name System In Modern Networking

That said, the host table name system has not gone away entirely. There are two circumstances in which this technique is still of value:

- 🕒 **Small “Island” Networks:** If you are setting up a small local area network using TCP/IP, and you don't need the names of your devices to be accessible by those outside your network, then guess what? You have the equivalent, of sorts, of the early Internet, and the host table system is as applicable to you as it was to the Internet in the 1970s. You can simply set up host tables on each device and manage them manually. As long as the LAN is small enough that editing these files periodically is not a hassle, this is actually a fast and effective name system, because no exchange of messages is needed for resolution. You can even maintain a master file on one machine and copy it to the others when changes are required using a script, to save time.
- 🕒 **Providing Local Name Mappings To Supplement DNS:** Even though modern systems use DNS for most name resolution, they also usually still support the use of host table files. You can manually enter common name mappings into this file, even for devices that are on the global Internet. Your system can then be set up to consult this list before making use of its assigned DNS server.

The use of the HOSTS file in conjunction with DNS allows you to manually specify mappings for commonly-accessed sites, which may provide a slight performance improvement since there is no need to access a server. Since the HOSTS file doesn't

enforce any particular structure to names, it is naturally quite possible to put DNS-style hierarchical names into the file, as I showed in [Table 162](#). The file is loaded into memory and used to *override* the normal DNS process for names listed in it.

Of course, you then subject yourself to all the potential maintenance headaches of manually-edited files: you must update these files as host names or addresses are changed in the DNS system. For this reason, this second use of the HOSTS file for Internet sites served by DNS is less popular than the use of the file for local machines.



Key Concept: Even though the host table name system is not the primary mechanism used for TCP/IP naming, it still used in two circumstances. The first is to implement a basic name system in a small local TCP/IP internetwork. The second is as an adjunct to DNS, where it allows manual mappings to be created that override the DNS process when needed.



TCP/IP Domain Name System (DNS)

The creation of [host tables](#) to map computer names to addresses greatly improved the usability of the early Internet and the TCP/IP protocol suite that implemented it. Unfortunately, while the host table name system worked well when the internetwork was small, it did not scale particularly well as the Internet started to grow in size and complexity. The name system had to stay but the use of host tables had to be dispensed with in favor of a newer, more capable system.

Over the period of several years, many engineers worked to create a system that would meet not just the needs of TCP/IP internetworks of the time, but also of the future. The new name system was based on a hierarchical division of the network into groups and subgroups, with names reflecting this structure. It was designed to store data in a distributed fashion to facilitate decentralized control and efficient operation, and included flexible and extensible mechanisms for name registration and resolution. This new name system for TCP/IP was called the *Domain Name System (DNS)*.

In this section I describe the concepts behind TCP's Domain Name System, as well as its operation. The section is divided into four subsections. The first provides an overview of DNS, including a description of its characteristics and components. The next three subsections describe how DNS implements each of the [three primary name system functions](#): the DNS name space and architecture; the DNS name registration process, including hierarchical authorities and administration; and the DNS name resolution process, focusing on how name servers and resolvers work. Finally, I have a topic that briefly highlights the changes made to DNS to support the new version 6 of the Internet Protocol, and its much longer addresses.



Background Information: I assume in this section that you are already familiar with the basics of name systems, and make reference to appropriate topics in the [name system overview](#) as needed. You should also be familiar with how TCP/IP host tables work, [as described in the topic preceding this section](#).



Note: Now, for a quick terminology note. First, even though the abbreviation “DNS” usually stands for “Domain Name System”, you will also sometimes see the “S” stand for other words, especially “Service” or “Server”. Second, some documents refer to this name system as “the DNS”. Most people just say “DNS” without the definite article, and that’s the convention I follow here as well.

DNS Overview, Functions and Characteristics

Most of us know that it's a lot easier to be a critic than a creator. It was easy to tell that the host table name system used on the fledgling TCP/IP Internet was not going to serve it going into the future, but finding a solution to this problem was much more difficult. The main reason the host table system was insufficient was that it was too simple, and this meant that its replacement, the *Domain Name System (DNS)*, had to be considerably more sophisticated. Naturally, this made DNS more difficult to design, and also means we have to devote more energy to understanding how it works.

As I like to do with the explanation of most of the complex systems and protocols in this Guide, I begin in this section with background information and an introduction to TCP/IP DNS. I start by providing an overview of DNS's development, history and standards, continuing the history begun in the overall look at TCP/IP name systems. I discuss the design goals and objectives of the creators of DNS, to help you understand better what its designers were trying to do. I then talk about the main components of DNS and the functions it performs, relating these to the basic functions explained in the overview section on name systems.

DNS Overview, History and Standards

The aversion that most people have to trying to remember numeric identifiers led to the very quick adoption of a name system for devices on the predecessors of what we now call the Internet. In the 1960s and early 1970s, names were given to machines, and these names maintained in host tables. The TCP/IP [host table name system](#) worked well for a number of years, with a centrally-maintained master list used by device administrators to ensure a consistent view of the network.

Unfortunately, such a system only works well when the number of devices is small. As the budding Internet grew, numerous weaknesses became apparent in the host table method, as I detailed in the section describing that system. Furthermore, the problems with the system weren't something that could be easily “patched” with small changes; the problems were structural, part of the basic idea of host tables as a whole. A completely new approach was needed for how names would be used on the Internet.

Early DNS Development and the Move to Hierarchical Domains

The most important “paradigm shift” made by the TCP/IP engineers was the decision to change the name system from one that used a single, centralized list of names to a more decentralized system. The idea was to create a structured topology where names were organized into *domains*. This idea was first introduced in the September 1981 RFC, 799, entitled [*Internet Name Domains*](#).

RFC 799 actually describes more the mechanics of delivering electronic mail messages between domains than the domains themselves. Interestingly, the standard assumes a flat structure of domains in its discussion, while mentioning the possibility of creating a hierar-

archical structure instead. It was in fact the decision to go to such a [hierarchical name space](#) for domains that led to the creation of the *Domain Name System (DNS)* in the form in which we know it today.

Many different RFC documents were published in the early 1980s, describing the development of different aspects of DNS. The first real milestone in DNS's history was probably the publishing, in November 1983, of a “triplet” of initial documents discussing DNS concepts, shown in [Table 163](#).

Table 163: Documents Discussing TCP/IP Domain Name System (DNS) Concepts

RFC Number	Name	Description
881	<i><u>Domain Names Plan and Schedule</u></i>	Discusses the issues involved in implementing the new DNS name system and how to migrate from the older host table system.
882	<i><u>Domain Names: Concepts and Facilities</u></i>	Describes the concepts and functional elements of DNS in fairly extensive detail. Includes a discussion of the name space, resource records, and how name servers and resolvers work.
883	<i><u>Domain names: Implementation Specification</u></i>	Provides the “nitty gritty” details on DNS messaging and operation.

Standardization of DNS and Initial Defining Standards

The documents above were discussed frequently over the months that followed, and the basic DNS mechanism revised many times. Several subsequent RFCs were published, updating the DNS cut-over plan and schedule. Finally, in November 1987, agreement on the operation of the system was finalized and a “quartet” of new RFCs were published that formalized the DNS system for the first time. These standards are RFCs 1032 through 1035, shown in [Table 164](#).

Table 164: Initial Standards Defining The TCP/IP Domain Name System (DNS)

RFC Number	Name	Description
1032	<i><u>Domain Administrators Guide</u></i>	Specifies administrative procedures and policies for those running a domain.
1033	<i><u>Domain Administrators Operations Guide</u></i>	Provides technical details on how to operate a DNS server, including how to maintain portions of the DNS distributed database of names.
1034	<i><u>Domain Names - Concepts and Facilities</u></i>	Replaces RFC 882, providing an introduction and conceptual description of DNS.
1035	<i><u>Domain Names - Implementation and Specification</u></i>	An update to RFC 883, specifying how DNS works in detail, including resource record definitions, message types, master file format, and resolver and name server implementation details.

These last two documents, RFCs 1034 and 1035, are considered the definitive original specification for the operation of the Domain Name System. While they are now many years old, they still provide the essential description of how DNS works.

DNS has quickly become a very important part of how both the Internet and TCP/IP work. As the Internet has grown to include thousands and then millions of sites, the importance of DNS has grown as well. Today, most people use DNS almost every time they use TCP/IP to access the Internet. It has gone from an alternative form of addressing for applications to one that is preferred by most users. It is an important building block of the more complete “application layer addressing” scheme developed for TCP/IP: [Uniform Resource Identifiers \(URIs\)](#).

The hierarchical nature of the [DNS name space](#) is the only thing that has allowed the Internet to grow while making the assignment and mapping of names manageable. The [authority structure](#) is also hierarchical, giving local administrators control over the names of devices they manage while ensuring name consistency across the hierarchy as a whole. The [distribution of data using many name servers and a standardized resolution technique](#) following a standard message protocol provides efficiency and reliability. These concepts will become more clear as we explore DNS more completely in later topics.

DNS Evolution and Important Additional Standards

TCP/IP and the Internet have both changed a lot since 1987, of course, and DNS has also had to change to suit. Many RFCs have been written since the base documents were published in the late 1980s, most of which further clarify the operation of DNS, expand on its capabilities, or define new features for it. You can find all of these by searching for “domain” or “DNS” in a list of RFCs. There are dozens of these, and I see no point in simply listing them all here, but I have highlighted a few of the more interesting ones in [Table 165](#).

Table 165: Additional DNS Standards (Page 1 of 2)

RFC Number	Name	Description
1183	<i><u>New DNS RR Definitions</u></i>	Defines several new “experimental” resource record types. Other subsequent RFCs have also defined new RRs.
1794	<i><u>DNS Support For Load Balancing</u></i>	Discusses load balancing for greater performance in DNS servers.
1995	<i><u>Incremental Zone Transfer in DNS</u></i>	Specifies a new feature that allows only part of a zone to be transferred to a secondary name server for efficiency.
1996	<i><u>A Mechanism for Prompt Notification of Zone Changes (DNS NOTIFY)</u></i>	Adds a new message type to DNS to allow primary (authoritative) DNS servers to tell secondary servers that information has changed in the main database.
2136	<i><u>Dynamic Updates in the Domain Name System (DNS UPDATE)</u></i>	Describes a technique for dynamically making resource record changes in the DNS database (also called Dynamic DNS).

Table 165: Additional DNS Standards (Page 2 of 2)

RFC Number	Name	Description
2181	<i><u>Clarifications to the DNS Specification</u></i>	Discusses several issues with the main DNS standards as defined in RFCs 1034 and 1035 and how to address them.
2308	<i><u>Negative Caching of DNS Queries (DNS NCACHE)</u></i>	Specifies the operation of negative caching, a feature that allows a server to maintain information about names that do not exist more efficiently.

Adapting DNS For IPv6

[IP version 6](#) was developed starting in the mid-1990s, and brought with it the need to make changes and enhancements to the operation of DNS. (Even though DNS operates at the higher layers, it deals intimately with addresses, and [addresses have changed in IPv6](#).) The modifications required to DNS to support IPv6 were first defined in RFC 1886, [IPv6 DNS Extensions](#), which was part of a group of RFCs that laid out the fundamentals of IPv6. Several subsequent standards have been published since that time; these are discussed in [the topic on IPv6 DNS](#).

The three topics following in this section provide a more complete overview of DNS and its development, by discussing the design goals of its creators, and the protocol's key characteristics.

DNS Design Goals, Objectives and Assumptions

[As we just saw in the preceding topic](#), the elapsed time from the first RFC discussing TCP/IP domain names to the publishing of the official standards describing the operation of DNS was over six years. This is a very long time for the development of a system, but it doesn't surprise me. A lot of thought had to go into the creation of DNS, to be certain that it would meet all of the many demands that would be placed upon it.

The first problem was that the creators of DNS had to worry about both how to define the new system and how to migrate from the old one. Considerable time was spent figuring out how all the existing hosts would be moved over to the new DNS name space and how the new protocols for exchanging DNS information would be implemented on them.

The creators of DNS knew they were making the new system because the old one didn't scale very well; they also knew that if migration was a difficult problem with the small number of hosts in existence at that time, it would be much more difficult if they had to go to another new system in the future. This made the key challenge in DNS to create a system that would meet the needs of the Internet not just the day it was introduced, or the following year, but even ten years or more down the road.

DNS Design Goals and Objectives

Back in the 1980s, nobody had any idea how the Internet would grow as it has in the last decade. That DNS still works as well as it does is a testament to the skill of its designers. Much of this success is due to the early groundwork put into the design of the system. DNS engineers documented some of what they considered to be the main design goals in creating it, which can help us understand not just what DNS does but why:

- ① **Creation Of A Global, Scalable, Consistent Name Space:** The name space had to be capable of spanning a large, global internetwork containing millions of machines. It was necessary that it provide a consistent and predictable method for naming devices and resources so they could be easily found. It was also, obviously, essential that name duplication be avoided, even when conflicts could potentially be between devices on different continents.
- ② **Local Control Over Local Resources:** Administrators of networks and small internetworks on the Internet as a whole needed to be able to have control over the naming of their own devices. It would not be acceptable to have to go through a central authority for naming every single object, nor would it be acceptable for every administrator to need to know the names of everyone else's networks and machines.
- ③ **Distributed Design To Avoid Bottlenecks:** The designers of DNS knew that they would have to abandon the idea of a centralized database in favor of a distributed approach to data storage, to avoid the bottlenecks that would result in using DNS with many devices.
- ④ **Application Universality:** The system had to be general enough that it would support a wide variety of applications. For example, it needed to support host identification, mail delivery and other functions.
- ⑤ **Multiple Underlying Protocol Support:** DNS needed to be inherently able to support different underlying protocols. (Many people don't realize, for example, that DNS can support not just IP addresses but other types of addresses, simply because IP is so dominant in networking today.)
- ⑥ **Hardware Universality:** Both large and small computers needed to be able to use the system.

Keep these objectives in mind as you learn more about DNS, and it will help you understand better why certain design attributes were chosen. For example, if we consider the first two objectives listed above, they seem almost contradictory: how can we have a global name space with unique names if individual administrators were able to assign local names? The answer, as we will see, is that this is where the power of the [DNS hierarchical name space](#) shines through.

DNS Design Assumptions

The goals above tell us what DNS's creators wanted to make sure the new system addressed. In addition, the engineers that worked on the protocol's implementation details had to make decisions based on certain assumptions of how it would be used. Some of the more significant of these assumptions:

-
- ④ **Rapidly Growing Database Size:** By the mid-1980s it was obvious that the DNS database of names would start out rather small but would grow quickly. The system needed to be capable of handling this rapid growth.
 - ④ **Variable Data Modification Rate:** Most of the data in the name database would change only infrequently, but some would change more often than that. This meant flexibility would be required in how data changes are handled, and how information about those changes was communicated.
 - ④ **Delegatable Organizational Responsibility:** Responsibility for portions of the name database would be delegated primarily on the basis of organizational boundaries. Many organizations would also run their own hardware and software to implement portions of the overall system.
 - ④ **Relative Importance of Name Information Access:** It was assumed that the most important thing about DNS was providing reliable name resolution, so the system was created so that it was always possible for a user to access a name and determine its address. A key decision in creating the system was deciding that even if the information is slightly out-of-date it is better than no information at all. If a name server were unable to provide the latest data to fill a request, it would return the best information it had available.
 - ④ **Handling of Requests For Missing Information:** Since the name data was to be distributed, a particular name server might not have the information requested by a user. In this case, the name server should not just say “I don't know”. It should provide a referral to a more likely source of the information, or take care of finding the data by issuing its own requests. This led to the creation of the several [DNS name resolution techniques](#): local, iterative and recursive.
 - ④ **Use Of Caching For Performance:** From the start, it was assumed that DNS would make extensive use of [caching](#) to avoid unnecessary queries to servers containing parts of the distributed name database.

Arguably, a lot more assumptions were made in creating this system, like every system. For example, DNS had to make assumptions about how exactly data would be stored, the transport mechanism for sending messages, the role of administrators and so on. We'll learn more about these as we go through our look at the system.

DNS Components and General Functions

To meet the many objectives set for it by its designers, DNS requires a great deal of functionality. It is a true name system with the emphasis on **system**, and as such is considerably more complex than the [host table name system](#) used earlier in TCP/IP. In [the section describing name systems in general](#), I divided the many tasks a fully-featured name system into three categories. DNS includes functions in all of these categories, and so using these categories is a good way to take a high-level look at the way DNS works.

The following are the three basic name system functions, and how DNS implements them (see [Figure 234](#)).

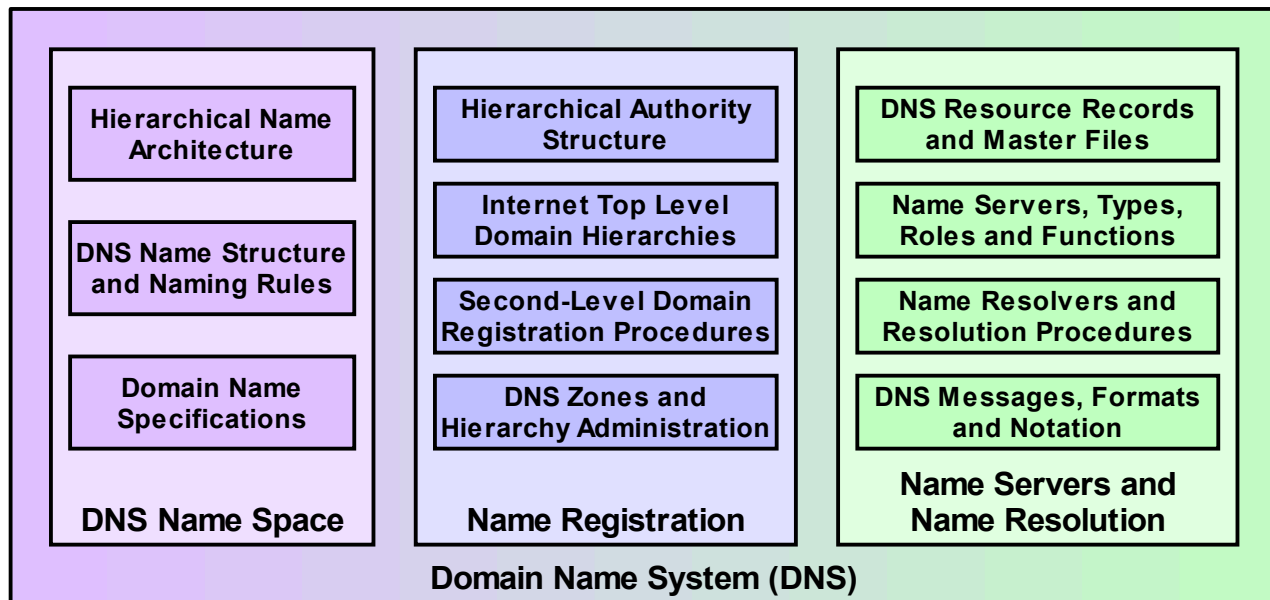

Figure 234: DNS Functions

Name Space

DNS uses a [hierarchical name space](#) consisting of a single, complex, multi-level structure into which all names in the system fit. The name space is organized starting from a single root into which “containers” (called *domains*) are placed. Each can contain either individual device names or more specific “sub-containers”. The overall structure is somewhat analogous to how a directory system on a computer organizes files from general to specific, using an arbitrary structure that can be optimized to various needs.

A specific syntax is used to define valid names, and special terminology used to describe parts of the structure and identify domain names, from the root down to the device level.

Name Registration (Including Administration and Authorities)

[DNS name registration](#) is used to enter individual names into the DNS distributed database. DNS uses a hierarchical arrangement of authorities that complements the hierarchical name space. A centralized authority determines the overall shape and structure of the name space, and handles registration of names at the highest level. Authority is then *delegated* to different organizations to manage various parts of the name space. A set of universal policies controls the registration process and deals with problems and conflicts.

Name Resolution

DNS uses a powerful, distributed, client/server [name resolution mechanism](#). This is probably the area where the most attention had to be put into the design of DNS, to ensure that it could scale to handle millions and eventually billions of name resolution requests each day.

The name resolution process is implemented using two basic software elements that play the role of client and server: name servers and name resolvers.

Name Servers

DNS name servers are special programs running on hardware servers that are the heart of DNS. Servers are maintained by organizations that have administrative control over part of the DNS name space, and contain *resource records* that describe names, addresses and other characteristics of those portions of the name space. As such, the servers themselves are arranged into a hierarchy analogous to that of the name space, though not identical in structure.

The main job of name servers is to receive requests for name resolution and either respond with the data requested from the database, or with the name of another name server that will lead to the requested information. Name servers are also responsible for data caching and other administrative tasks to ensure efficient operation of the system as a whole.

Name Resolvers

Name resolvers are the usual clients in the name resolution process. When a user makes reference to a name in a networking application, the name is passed to the resolver, which issues a request to a name server. Depending on the configuration, more than one request may be needed, and several different resolution processes may be combined to find the needed information. Resolvers too may employ caching or implement other features.



Note: The division between resolvers and servers is based on role. As we'll see when we look at name resolution, name servers may also function as clients in certain exchanges of data. [See the topic on DNS messaging for an explanation of this apparent paradox.](#)

If this seems a lot like the “classic” description of a name system that I gave in the name system concepts section, that's not a coincidence; DNS is considered *the* name system against which most others are usually compared. If you understand these high-level descriptions, then you already know the basics of how DNS works. The next three sections delve into each of these three functional areas in more detail, and will help you really learn how DNS does its thing.



Key Concept: As a complete name system, DNS provides numerous capabilities that implement each of the three basic name system functions. The DNS *name space* is hierarchical and is organization using a multi-level structure with particular naming rules. The DNS *name registration system* is based on the idea of a hierarchy of

domains and registration authorities responsible for them. DNS *name resolution* is similarly hierarchical, and designed around interaction between *name resolver* and *name server* software components that consult databases of DNS *resource records* and communicate using a special messaging protocol to answer client queries.



DNS Name Space, Architecture and Terminology

The name space is the most fundamental part of any name system, since it is what defines the ways that the names themselves are created. The name space tells us what form names may take, and provides the rules for how they are created. Most importantly, it specifies the *architecture* of the names—the internal structure of names themselves. This in turn has a critical influence on how name registration and resolution work, making an examination of name space and architecture issues the obvious place to start in learning the details of DNS.

In this section I describe the concepts behind the DNS name space and its structure. I begin with an overview of the DNS name space and description of the hierarchical architecture it uses. I then provide more detail on the name structure, and also explain the terminology often used to refer to parts of the name space. I provide a formal description of DNS labels and the official and unofficial rules for creating domain names. I conclude with a description of domain name specifications, and explain the concept of “qualification” and how fully-qualified and partially-qualified names differ.

DNS Domains and the DNS Hierarchical Name Architecture

The most important element of a name system's name space is its *name architecture*, which describes how names are constructed and interpreted. The architecture of the Domain Name System is, unsurprisingly, based on the concept of an abstraction called a *domain*. This is obviously a good place to start in explaining how DNS works. Unfortunately, it's not the easiest concept to explain from scratch, so as usual, I'll do my best and ask for your patience. ☺

The Essential Concept in the DNS Name Space: Domains

Dictionary definitions of the word “domain” generally convey the notion of a *sphere of influence*, or *area of control or rulership*. An essential concept is that in many different contexts, control or authority can be exerted at many different levels. One sphere of influence may contain smaller ones, which can in turn contain smaller ones still. This means that such domains are naturally arranged in a hierarchy.

An obvious example would be geopolitical domains. We have no centralized “world government” on earth, but we do have the United Nations, which deals with world-wide issues. At the next level down, we have individual countries. Some of these countries have divisions such as states and provinces. Still lower levels have counties, municipalities, neighborhoods and individual residences or businesses. The “domains” are inherently hierarchical in organization.

The Domain Name System uses the word *domain* in a manner very similar to this, and employs a hierarchical structure that works in much the same way as the geopolitical example. In DNS, a *domain* is defined as either a single object or a set of objects that have been collected together based on some type of commonality. Usually in DNS that commonality is that they are all administered by the same organization or authority, which makes the name hierarchy tightly linked to the notion of the [DNS hierarchical authority structure](#).



Note: The term “domain” is also used in other contexts in the world of networking. The most notable example of this is the use of the term in Microsoft networking, where it too is used to represent the notion of a collection of objects under common authority. However, the two types of domain are completely different and not related beyond this conceptual level.

The DNS Hierarchical Tree Structure of Names

One could construct a tree diagram with the United Nations on top with lines pointing to each of the countries on earth. Then, within the United States, for example, we could draw lines to each of the states; within each state, lines to each county and so on. The result would be something that looks like an upside-down tree, as we can see in [Figure 235](#). This is called a *tree structure*.

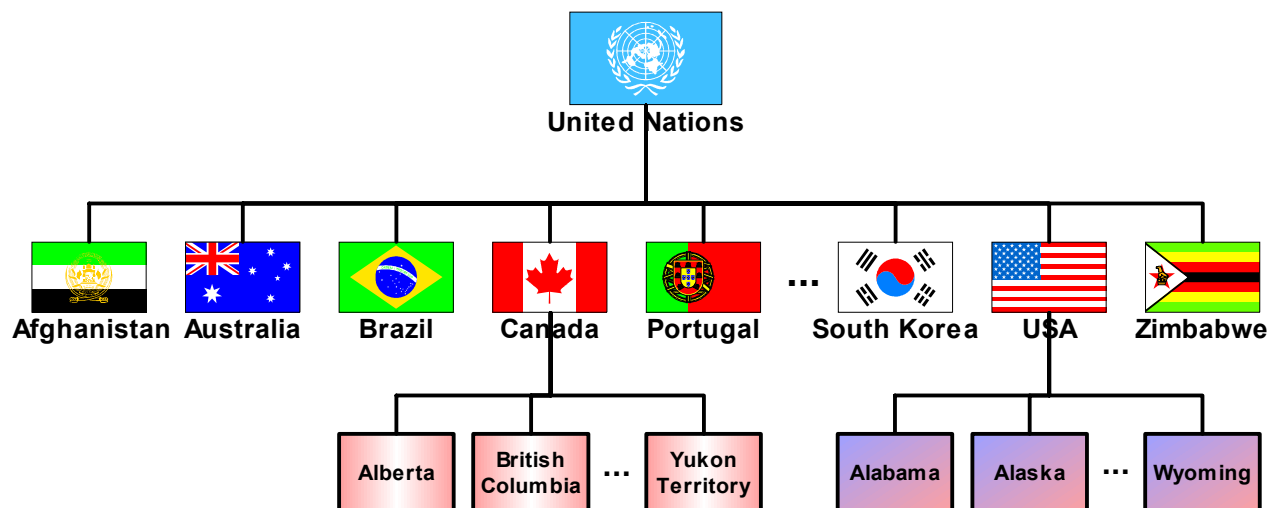

Figure 235: Example of a Global Hierarchical Domain Architecture

This diagram shows an example of hierarchical architecture, based on political divisions. The United Nations is an umbrella organization representing (to one extent or another) all of the world’s nations. It is the *root* of the tree; underneath it we find individual nations. Each nation then is further subdivided in a manner it chooses; for example, Canada has provinces and territories, and the USA individual states. These can in turn be further subdivided in any number of ways.

Trees are used all over computing and networking; for example, trees are a type of LAN topology. For our purposes in explaining DNS, the best example of a tree structure is the directory tree used to store files on a computer's hard disk or other storage devices. The root directory is at the top of the structure and may contain named files and/or named directories. Each directory can itself contain individual files or subdirectories, which can in turn contain their own subdirectories, and so on.

The domain name structure in DNS is conceptually arranged in exactly the same way, only instead of dealing with files, DNS deals with named objects, usually devices like IP hosts. The highest level is still the *root* of the tree. It contains a number of domains, each of which

can contain individual objects (names) and/or lower-level domains. Lower-level domains can in turn have still lower-level domains, allowing the tree as a whole to take on an arbitrary structure.

The Benefits of the DNS Hierarchical Name Architecture

Like a directory structure, the DNS hierarchical name architecture allows names to be organized from most general to most specific. It also has complete flexibility, allowing us to arrange the structure in any way that we want. For example, we could make a name system that is structured exactly paralleling the geopolitical organization chart I described earlier. We could have the root of the name structure represent the “United Nations”, and create a domain for each country. Then for those countries that have states, like the United States, we could create “state domains” within those countries. Smaller countries not needing those domains could have “city domains” directly under the country domain. The hierarchy is flexible, because at each level it can be given a suitable substructure.



Key Concept: The DNS name space is arranged into a *hierarchy of domains* shaped like an inverted tree. It is structurally similar to the directory structure of a file system, with a root that contains domains, each of which can contain subdomains and so forth.

It's important to remember that every standalone internetwork can have its own name space and unique hierarchical structure. Many times, people conflate the idea of “a DNS name space” with “*the* DNS name space”. The latter refers to the DNS hierarchy used for the global Internet, and it's obvious that this deserves a great deal of attention. But it is just one possible arrangement, if an important one, of an infinite number of possible structures.

In the remaining topics of this section, I continue the generic descriptions of DNS name space and architecture, including a look in the next topic at [DNS names and terminology](#). [The section on name registration and authorities](#) provides more specific information on the Internet's DNS hierarchy. As we'll see there, [geopolitical structures are in fact used](#) in a manner similar to what I described above to assign names to some of the Internet's computers, but other parts of the hierarchy are different.

DNS Structural Elements and Terminology: Domains, Subdomains, and Nodes; Roots, Leaves and Branches; Parents, Children and Siblings

Now that we understand the fundamentals of the Domain Name System's name space, let's look at the DNS structure in more detail. At the same time, we can get a better handle on the many different terms used to refer to parts of the DNS domain name hierarchy.

DNS Tree-Related Terminology

We saw in [the previous topic](#) that the DNS name structure is shaped somewhat like a tree; the comparison between structured elements and trees is a common one in networking. The main difference between technology and biology here is that DNS trees grow from the top down, instead of reaching for the sky. The analogy to a tree naturally leads to the use of several tree-related terms in describing the DNS name structure, some of which are illustrated in [Figure 236](#):

- ☉ **Root:** This is the conceptual top of the DNS name structure. The root domain in DNS contains the entire structure. By definition, it has no name; it is *null*.
- ☉ **Branch:** A branch is any contiguous portion of DNS hierarchy. It consists of a domain and all the domains and objects within it. All branches connect together to the root, just like in a real tree. (Yes, it would be better if the root were called the *trunk*, but computer science majors apparently don't take botany as electives. ☺)
- ☉ **Leaf:** This is an “end object” in the structure, that is, a domain that doesn't have anything underneath it. Again, the analogy to a leaf being at the end of a sequence of branches is apt.

There is no specific term to refer to a domain that is not a leaf. These are sometimes called *interior nodes*, meaning that they are in the middle of the structure. A *node* is the generic computing term for an object in a topology or structure; it is used throughout this Guide. So, in DNS, every node is a domain, and may be either an interior node that contains additional domains and/or objects, or a leaf that is a specific named device. The term *domain* is thus somewhat ambiguous, as it can refer to either a collection of objects which represents a branch of the tree, or a specific leaf.

DNS Domain-Related Terminology

There are also several “domain-like” terms that are often used to refer to domains at different levels of the hierarchy. These terms, shown in [Figure 236](#), include:

- ☉ **Root Domain:** This is the root of the tree, as before.
- ☉ **Top-Level Domains (TLDs):** These are the highest-level domains directly under the root of the tree. They are also sometimes called *first-level domains*.
- ☉ **Second-Level Domains:** Shockingly enough, these are the domains located directly below the top-level domains.
- ☉ **Subdomains:** In some contexts, this term refers only to domains that are located directly below the second-level domains (but see below).



Key Concept: The top of the DNS name space is the *root*; under the root come *top-level domains*, and within these are *second-level domains* and then *subdomains*. In theory, any number of levels of subdomains can be created. A *branch* is any contiguous portion of the DNS tree; a *leaf* is a domain with nothing underneath it in the structure, and usually represents a single device.

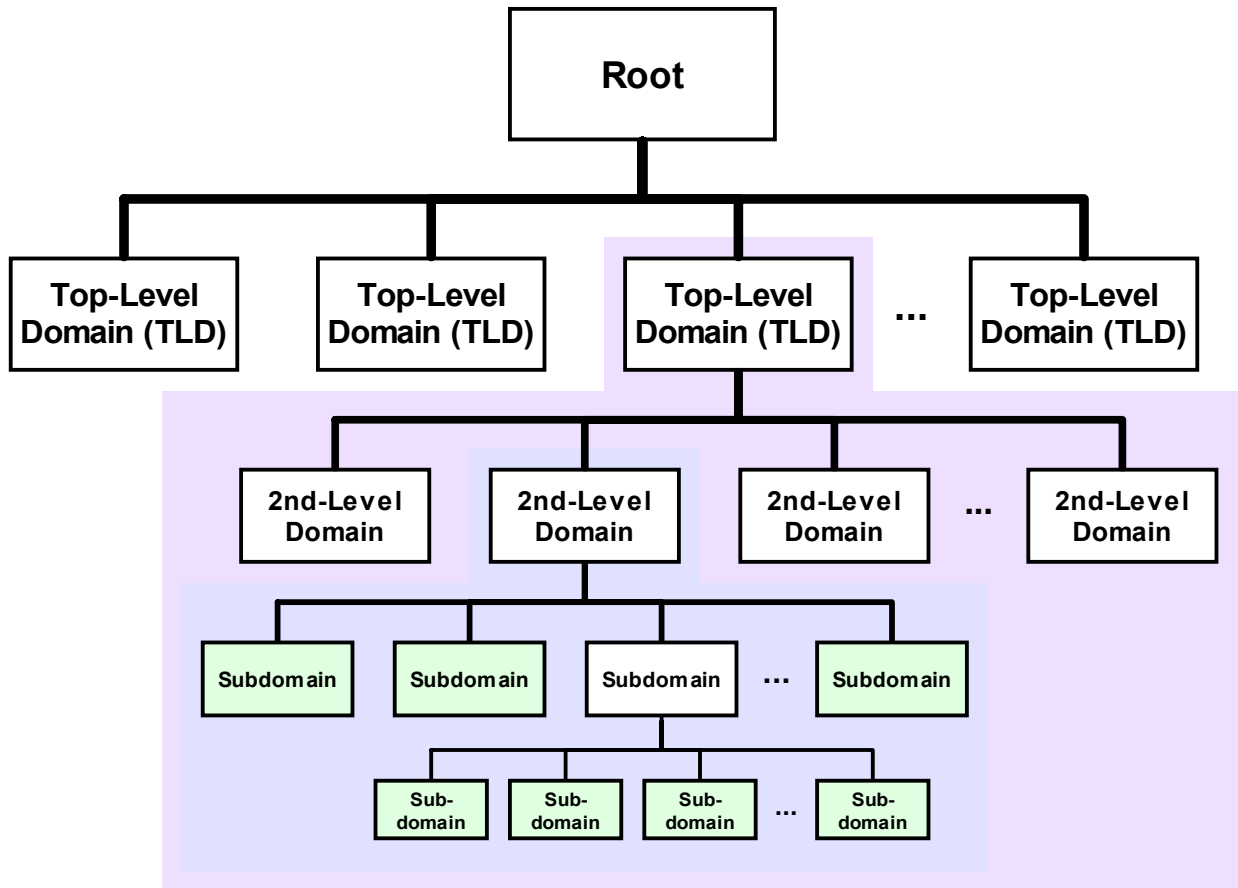

Figure 236: DNS Name Space Tree and Domain-Related Terminology

The top of the DNS name space is the root of the tree, and has no name. Under the root comes any number of top-level domains (TLDs); within each of these can be placed second-level domains, then within those subdomains, and so forth.

Some of the “tree” terminology used in DNS is also shown here. The portion of the tree with the purple background is one branch; the blue area highlights a smaller “sub-branch” within that branch. The green nodes within that blue area are the leaves of that smaller branch of the tree.

The term “subdomain” can also be used generically, like the word “domain” itself. In that case, it refers simply to the relationship between two domains, with a subdomain being under another domain in the structure. This means, for example, that top-level domains can be said to be subdomains of the root; every second-level domain is a subdomain of a top-level domain, and so on. But again, sometimes “subdomain” means specifically a third-level or lower domain.

DNS Family-Related Terminology

Another set of terminology you will run into compares the DNS tree structure not to a living tree, but in fact, to another analogy: a family tree. These terms are most often used to describe how a particular domain under discussion relates to the other domains or subdomains around it, so they are relative terms. The ones usually seen are (see [Figure 237](#)):

- ☉ **Parent Domain:** The domain that is above this one in the hierarchy. For example, the root domain is the parent of all top-level domains.
- ☉ **Child:** A domain at the next level down from this one in the hierarchy. Thus, the top-level domains are children of the root.
- ☉ **Sibling:** A peer at the same level as this one in the hierarchy, with the same parent. Thus, all top-level domains are siblings with the root as a parent; all second-level domains within a particular TLD are siblings and so on.

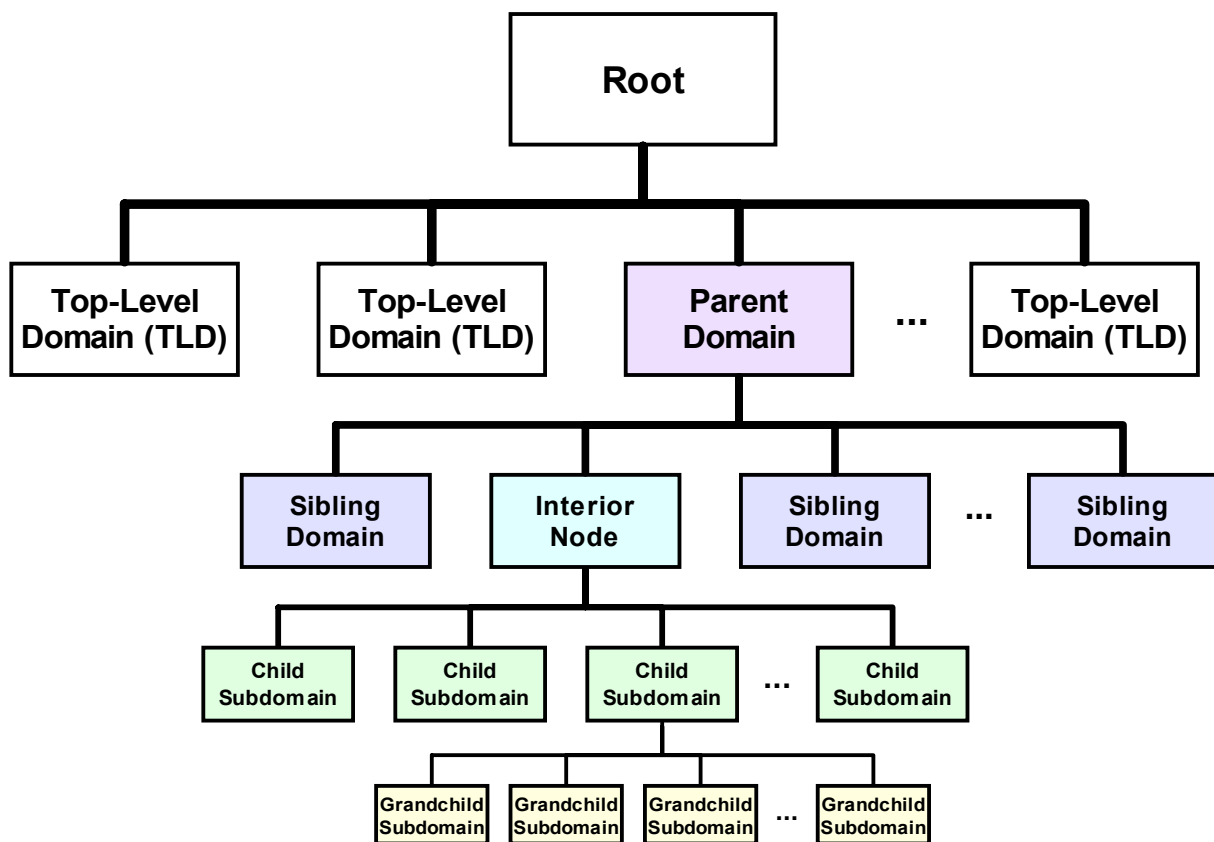

Figure 237: DNS Name Space “Family Tree”

This diagram is similar to [Figure 236](#), but I have labeled the nodes differently to show the “family-oriented” terminology sometimes used in DNS. In this case, the names are relative to the interior node shown in cyan. The domain immediately above it is its parent node; other nodes on the same level are siblings, and subdomains within it are children of that node.



Key Concept: The domain above a given domain in the DNS name space is called its *parent domain*; domains at the same level within the same parent are *siblings*; and subdomains are called *children* of that domain.

Restrictions on DNS Tree Structure

Note that like a real tree, the DNS name structure must be a **true** tree in its structure. Every domain can have only one parent (except the root), just as every branch of a tree connects to only one limb (except the root/trunk). Also, no “loops” can appear in the structure; you can't have a domain whose child is also its parent, for example.



Key Concept: A DNS name space must be arranged as a true topological tree. This means each domain can have only one parent, and no “loops” are permitted in the structure.

I also want to point out that even though the name hierarchy represents an arrangement of named devices, it is only a **logical** structure. There is no necessary correspondence to the physical location of devices. A domain with ten children may represent 11 devices in 11 different countries. [We'll explore this more when we look at DNS authority structures.](#)

DNS Labels, Names and Syntax Rules

We've seen how the DNS name space hierarchy allows us to arrange domains into a virtual tree that reflects the characteristics of how the devices themselves are organized. While using a hierarchical name space is inherently more complex than a flat name space, it yields a powerful result: the ability to specify names that can be locally managed while remaining globally unique. At the same time, the complexity of the tree yields the benefit of relatively simple name construction using domain identifiers.

DNS Labels and Label Syntax Rules

Naming in DNS begins with giving each domain, or node, in the DNS name space a text *label*. The label identifies the domain within the structure, and must follow these syntax rules:

- ☉ **Length:** Each label can theoretically be from 0 to 63 characters in length. In practice, a length of 1 to about 20 characters is most common, with a special exception for the label assigned to the root of the tree (see below).
- ☉ **Symbols:** Letters, numbers are allowed, as well as the dash symbol (“-”). No other punctuation is permitted, including the underscore (“_”).
- ☉ **Case:** Labels are not case-sensitive. This means that “Jabberwocky” and “jabberwocky” are both permissible domain name labels, but they are equivalent.

DNS Label Uniqueness Requirement

Every label must be unique **within its parent domain**. So, for example, if we have a top-level domain (TLD) called “rocks”, we can only have one subdomain within “rocks” called “crystal”. Due to the case insensitivity of labels, we cannot have both “CRYSTAL” and “crystal” within “rocks”, because they are considered the same.

It is this concept of “local uniqueness” within a parent domain that ensures the uniqueness of names as a whole, while allowing local control over naming. Whoever is in charge of the “rocks” domain can assign names to as many individual objects or subdomains as he likes as long as they are unique within the domain. Someone else, say, the maintainer of the “glass” domain, can also create a subdomain called “crystal” within “glass”; there is no conflict because the “glass” and “rocks” domains are separate. Of course, since all top-level domains have the same parent (the root), all TLDs must be unique.



Key Concept: Each node in the DNS name space is identified by a *label*. Each label must be unique within a parent domain, but need not be unique across domains. This enables each domain to have local control over the names of subdomains without causing any conflict in the full domain names created on a global level.

Constructing Domain Names From Domain Labels

Each individual domain within the domain name structure can be uniquely identified using the sequence of labels that starts from the root of the tree and progresses down to that domain. The labels at each level in the hierarchy are listed in sequence, starting with the highest level, from right to left, separated by dots. The result is the formal definition of a *domain name*.

The root of the name space is given a zero-length, “null” name by default. That is, the label for the root exists, it’s just empty. This little bit of geekery is done because the root technically is part of every domain name. This means it must be included in every domain name. If it were something long like “root”, we would have to include that at the end of every domain name. This would simply make every name longer, while not really adding any useful information—we already know every domain name is under the root.

Let’s take the example above again, of a top-level domain called “rocks”, within which is a second-level domain “crystal”. The domain name of “rocks” is “rocks.”, with the dot separating “rocks” and “” (the null root). In practice, the trailing dot is often omitted, so the domain name of the TLD “rocks” can be considered to be just “rocks”. The subdomain “crystal” within “rocks” has the domain name “crystal.rocks”. If we had a named device called “salt” within the “crystal.rocks” domain, it would be called “salt.crystal.rocks”. This is pretty straight-forward, as you can see in the very simple [Figure 238](#).

We can use these names to easily identify subdomains of a particular domain. For example, if we start with “salt.crystal.rocks”, it’s obvious that “crystal.rocks” is its parent domain. It’s also clear that both “crystal.rocks” and “salt.crystal.rocks” are subdomains of “rocks”; one is a single level down from “rocks” and the other is two levels down.

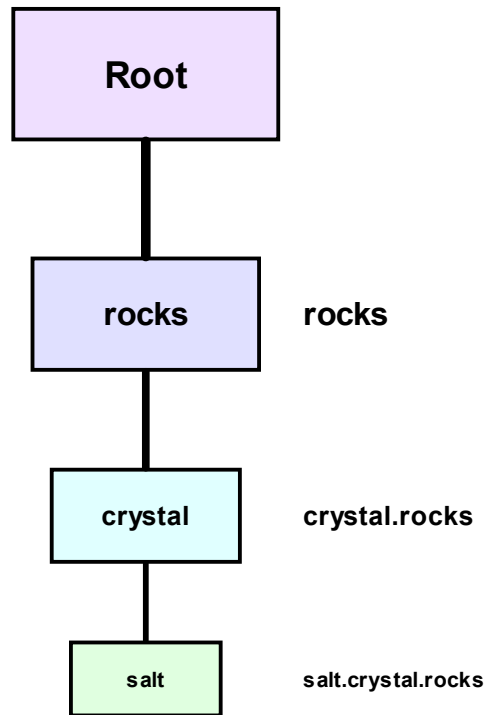

Figure 238: DNS Labels and Domain Name Construction

Each node in the DNS name space has a label (except the root, whose label is null). The domain name for a node is constructed simply by placing in order the sequence of labels from the top of the tree down to the individual domain, going from right to left, separating each label with a dot (period).

DNS Name Length Limit

There is a maximum limit of 255 characters for a complete domain name, for implementation purposes. In practice, most domain names are much shorter than this limit, as it would violate the whole purpose of domain names if we let them get so long that nobody could remember them anyway.

Resource Specification

In many protocols, it is possible to specify a particular resource within a domain name by providing a directory structure after a name. This is done using the standard TCP/IP uniform resource locator (URL) syntax, where a path is indicated using slashes to separate subdirectories. For example, a specific file at “salt.crystal.rocks” might be located at “salt.crystal.rocks/chem/composition”.

While DNS names are case-insensitive, the labels in a URL path are *not*. So this example would be different from “salt.crystal.rocks/chem/Composition”. [See the topic on URL syntax for more details.](#)



Key Concept: A *domain name* is a string of text that uniquely identifies a particular node in the name space. The domain name for a node is constructed by concatenating in right-to-left order all the labels in the branch of the DNS tree starting from the top of the tree down to the particular node, separating each by a dot (period.)

Absolute (Fully-Qualified) and Relative (Partially-Qualified) Domain Name Specifications

The [previous topic](#) showed how we can specify the domain name of any node in the DNS name hierarchy. We simply start at the root node and follow the sequence of subdomains down to the node in question, listing each level's labels separated by a dot. When we do this, we get single name that uniquely identifies a particular device.

Fully-Qualified Domain Names (FQDNs)

Technically, if a top-level domain “A” contains a subdomain “B” that in turn contains subdomain “C”, the full domain name for “C” is “C.B.A.”. This is called the *fully-qualified domain name (FQDN)* for the node. Here, the word “qualified” is synonymous with “specified”. The domain name “C.B.A.” is fully-qualified because it gives the full location of the specific domain that bears its name within the whole DNS name space.

Fully-qualified domain names are also sometimes called *absolute* domain names. This term reflects the fact that one can refer unambiguously to the name of any device using its FQDN from any other portion of the name space. Using the FQDN always instructs the person or software interpreting the name to start at the root and then follow the sequence of domain labels from right to left, going top to bottom within the tree.

Partially-Qualified Domain Names (PQDNs)

There are also some situations in which we may refer to a device using an incomplete name specification. This is called a *partially-qualified domain name (PQDN)*, which means that the name only partially specifies the location of the device. By definition, a PQDN is ambiguous, because it doesn't give the full path to the domain. Thus, one can only use a PQDN within the context of a particular parent domain, whose absolute domain name is known. We can then find the FQDN of a partially-specified domain name by appending the partial name to the absolute name of the parent domain. For example, if we have the PQDN “Z” within the context of the FQDN “Y.X.”, we know the FQDN for “Z” is “Z.Y.X.”

Why bother with this? The answer is convenience. An administrator for a domain can use relative names as a short-hand to refer to devices or subdomains without having to repeat the entire full name. For example, suppose you are in charge of the computer science department at the University of Widgetopia. The domain name for the department as a whole is “cs.widgetopia.edu.” and the individual hosts you manage are named after fruit.

In the DNS files you maintain you could refer to each device by its FQDN every time; for example, “apple.cs.widgetopia.edu.”, “banana.cs.widgetopia.edu.” and so on. But it's easier to tell the software “if you see a name that is not fully qualified, assume it is in the ‘cs.widgetopia.edu’ domain”. Then you can just call the machines “apple”, “banana”, etc. Whenever the DNS software sees a PQDN such as “kiwi” it will treat it as “kiwi.cs.widgetopia.edu”.



Key Concept: A *fully-qualified domain name (FQDN)* is a complete domain name that uniquely identifies a node in the DNS name space by giving the full path of labels from the root of the tree down to that node. It defines the *absolute* location of a domain. In contrast, a *partially-qualified domain name (PQDN)* only specifies a portion of a domain name. It is a *relative* name that has meaning only within a particular context; the partial name must be interpreted within that context to fully identify the node.

Differentiating FQDNs and PQDNs in DNS

I mentioned in the prior topic that the trailing dot for the null root domain is usually omitted. This is true in common parlance, and when users specify a domain name in an application; you don't use the trailing dot in your Web browser for instance. However, within DNS itself, the dot is used to clearly distinguish a FQDN from a PQDN within DNS master files. This allows us to use both FQDNs and PQDNs together. In the example above, “apple” would refer to “apple.cs.widgetopia.edu.”, but “apple.com.” would refer to the fully-qualified domain name for Apple Computer, Inc. You have to be careful about watching the dots here, because “apple.com” (no trailing period) would be a PQDN, and would refer to “apple.com.cs.widgetopia.edu.”, and **not** the domain of Apple Computer.



DNS Name Registration, Public Administration, Zones and Authorities

The [DNS name space](#) consists of a hierarchy of domains and subdomains. From the root we have a number of top-level domains, then second-level domains below them, and still lower-level domains below that. The obvious questions then become: how do we determine the shape and structure of the name space, and who will manage it? More specifically, who will control the root of the tree and decide what the top-level domains will be called? How will we then subdivide control over the rest of the name space? How do we ensure there are no conflicts in choosing the names of sibling subdomains within a domain?

DNS can be used on private networks controlled by a single organization, and if so, the answer to my questions above is obviously, “that organization”. We'll discuss private naming, but in reality, it's just not that interesting. The vast majority of DNS use occurs on the public Internet. Here, we have a much greater challenge, because we have to construct a name space that spans the globe and covers millions of machines managed by different organizations. For this, we need a very capable *name registration* process and administration methods to support it.

In this section I describe the process of name registration and how authorities are managed within the Domain Name System, focusing on the public Internet. I begin with a description of the DNS hierarchical authority structure and how it relates to the hierarchical name space, and a discussion of the concepts behind the DNS distributed name database. I describe the Internet's organizational and geopolitical top-level domains, and how they are administered by various authorities. I then discuss how authority is delegated to the second-level and lower-level domains, and how public registration of domain names works, including how public registration issues and problems are resolved. I explain how the DNS name space is partitioned into administrative zones of authority, and conclude with a brief discussion of private DNS name registration.



Related Information: Most TCP/IP implementations include a special utility called *whois* that can be used to interrogate the DNS distributed name database to obtain registration information about domains. This application can be very useful for troubleshooting; for details, [see the topic discussing whois in the section on TCP/IP administration utilities](#).

DNS Hierarchical Authority Structure and the Distributed Name Database

I began [my description of the DNS name space](#) with a dissertation on the central concept of naming in DNS: that of the *domain*. Each domain can be considered [akin to a sphere of influence or control](#). A domain “spreads its wings” over all the objects and subdomains that it contains. Due to this concept of influence, when we consider any DNS name space, we see that it is hierarchical because it reflects a hierarchy of organizations that control domains and the nodes within them. This means that there is in fact a *hierarchical authority structure* that complements the hierarchical name structure in DNS.

The DNS Root Domain Central Authority

The primary reason why the name space hierarchy leads to an authority hierarchy is the requirement that [sibling subdomains be unique within a domain](#). As soon as we have a need for uniqueness, this means we must have some sort of authority or process that ensures that each subdomain or object picks a different name within that domain. This is in fact what name registration is all about.

This concept of a hierarchical authority structure is a bit abstract, but it's easier to understand if we examine a sample DNS name space and discuss the issues involved in assigning names within it. Naturally, we will want to start at the top of the [name hierarchy](#), with the root domain, “null”. To start off the name space we must create top-level domains (TLDs) within the root. Now, each of these must be unique, so one authority must manage the creation of all TLDs. This in turn means that the authority that controls the root domain controls the entire name space.

In the case of the Internet, then, this central authority is ultimately responsible for every name in DNS. The central DNS authority for the Internet, which controls the creation of TLDs, was initially called the *Network Information Center*. It was later the *Internet Assigned Numbers Authority (IANA)*, which is also responsible for protocol numbers, IP addresses and more. These functions are now shared by IANA and the *Internet Corporation for Assigned Names and Numbers (ICANN)*. We'll discuss the specific TLDs of the Internet in the next few topics; IANA/ICANN and related organizations are discussed in [the topic on Internet registration authorities](#).

Top Level Domain Authorities

At the next level down in the authority hierarchy, we create second-level domains within each of the TLDs. Each TLD must itself be managed using a coordinating authority, however, this is not necessarily the organization that runs the root (IANA). IANA *delegates* authority for some of the TLDs to other organizations. They may delegate control for each TLD to a different authority at this level of the hierarchy. In fact, there can be completely different rules for managing the creation of second-level domains in one TLD than there are in another.

We'll see more of how this works later in the section. We'll also discover that in some TLDs there are in fact ***multiple*** authorities that work together on name registration.

Lower-Level Authority Delegation

The process of authority delegation continues as we continue down the name space hierarchy. At each level the name space becomes more specific; if we use an [organizational hierarchy](#), like the “.COM” top-level domain, we generally delegate authority for each second-level domain to the organization whose name it represents. So “IBM.COM” is managed by IBM, and so forth. Since IBM is huge, it may itself subdivide the authority structure further, but smaller organizations probably won't.

I want to point out explicitly that the authority hierarchy is **complementary** to the name hierarchy; they are not exactly the same. It is not necessary that there be a different authority for every level of the hierarchy. In many cases a single authority may manage a section of the name space that spans more than one level of the structure. For example, IANA manages the Internet root domain (“null”) and also the “.INT” top-level domain, but other TLDs are managed by other organizations. The name hierarchy is divided into *zones of authority* that reflect [the hierarchy of authorities that manage parts of the name space](#).

It's also worth remembering that authority over a domain doesn't necessarily imply physical control. A domain can contain subdomains that are managed by organizations on different continents, and a single subdomain can contain named devices that are on different continents as well.

The DNS Distributed Name Database

Of course, with authority comes responsibility, and the main responsibility an authority has for a domain is registering names within the domain. When a name is registered, a set of data is created for it, which can then be used by internetwork devices to resolve the name into an address, or perform other functions. The set of all the data describing all DNS domains constitutes the DNS *name database*. Just as registration authority is distributed and hierarchical, this database too is distributed and hierarchical.

In other words, there is no single place where all DNS name information is stored. Instead, DNS servers carry [resource records](#) that describe the domains for which they have authority. As we'll see, the fact that this database is distributed has major implications on how name resolution is carried out.



Key Concept: The name space of the public Internet is managed by a *hierarchy of authorities* that is similar in structure to the hierarchical DNS name space, though not identical. The top of the hierarchy is centrally managed by IANA/ICANN, which delegates authority to other organizations for registering names in various other parts of the hierarchy. The information about name registrations is maintained in resource records stored in various locations, which form a distributed name database on the Internet.

DNS Organizational (Generic) Top Level Domains and Authorities

The top of the DNS name hierarchy is managed by a central authority, which controls the entire name space by virtue of deciding what top-level domains (TLDs) are allowed to exist. Obviously, it is very important that a great deal of thought go into how the TLDs are chosen; a poor design at this top level would make the entire hierarchy poorly reflect the actual structure of organizations using the name space.

There are any number of ways that the creators of DNS could have chosen to structure the Internet's name hierarchy. One obvious possibility would be to structure the Internet based on geopolitical boundaries: countries, states and so forth, [as we saw in a topic in the last](#)

section. Another sensible idea is to structure the name space based on types of organizations. One could imagine other possible ways to divide up the names of the world's computers as well.

The beauty of the hierarchical name space is that we don't have to choose between different methods of structuring the name space. We can use more than one technique at the same time, and this is exactly what was done when DNS was first implemented. Both of the methods I described above, based on organization type and geography, were used for TLDs. This gives multiple options for name registration for most groups and individuals. I'll begin here by discussing organizational TLDs; geopolitical ones are the subject of [the topic that follows](#).

Original Generic TLDs

The initial deployment of DNS featured a set of seven top-level domains that are in the standard called *generic* TLDs. The idea was that each company or organization could choose a name within one of these TLDs; they were “generic” enough that every organization would find a place that suited them. I prefer to call them *organizational*, because they divide the generic portion of the name space by organization type. The initial TLDs and their original intended organization types were:

- ☉ **.ARPA:** A temporary domain used many years ago for transition to DNS. Its name refers to the ARPAnet, the precursor of the modern Internet (in turn named for the *United States Defense Advanced Research Projects Agency, ARPA*). Today this domain is used for [reverse name resolution](#).
- ☉ **.COM:** Corporations and businesses.
- ☉ **.EDU:** Universities and other educational organizations.
- ☉ **.GOV:** Government agencies.
- ☉ **.MIL:** Military organizations.
- ☉ **.NET:** Organizations that implement, deal with or manage networking technologies and/or the Internet.
- ☉ **.ORG:** Other organizations that don't fit into any of the classifications above.

At first glance this seems like a reasonable way to cover the organizations of the world. However, since the .ARPA domain is “temporary”, this left only six categories for all other organizations. Also, the TLDs weren't all used as was originally foreseen; for example, the .GOV and .MIL domains were not used for all types of government and military organizations, but primarily for the United States federal government and military. .EDU ended up being used only for universities, again in the United States.

This left only three common top-level domains—.COM, .NET and .ORG—for almost all other groups and companies that wanted to use the organizational hierarchy. Since there were only three such TLDs, they quickly became very “crowded”, especially the .COM domain. A new fourth domain, .INT for international organizations, was added fairly soon to the original seven, but it too was only for a small number of organizations, such as interna-

tional standards bodies. Despite the handful of organizational TLDs, there is no doubt that they have been much more popular than the geopolitical ones. I explain some of the reasons for this in [the next topic](#).

New Generic TLDs

There was, of course, no inherent reason why it was necessary to limit the generic domains to only that the few that were originally created. Over the years, many suggestions were made for new generic TLDs that would expand the number of possible second-level domain names and also provide better categorization for different organization types—that is, make the generic TLDs “less generic”. There was some resistance at first to adopting these new names, especially because there were so many different ideas about what new TLDs should be created. As I said before, creating TLDs must be done carefully to ensure that the name hierarchy makes sense.

IANA took input from a lot of people, and followed a complex procedure-that-I'd-rather-not-get-into-here ☺ to determine what new TLDs should be made. In 2001 and 2002, approval was given for the creation of several new top-level domains, and decisions made about authorities for administering them.

Of the new TLDs approved in the last few years, the number that has achieved widespread popularity is, to my knowledge, zero. Humans are creatures of inertia, and most people are still used to names ending in .COM, .NET or .ORG. In time this may change, but it will probably take a few years.

Incidentally, there are some people who actually felt that adding new generic TLDs was a **bad** idea, since it makes organizations potentially more difficult to locate (due to the possibility of a name ending in a variety of different TLDs). This is debatable, however, especially since the exhaustion of address space in the existing TLDs means many companies have had to choose unintuitive domain names anyway.

Summary of Organizational (Generic) TLDs

Table 166 shows all the current generic TLDs and describes how they are used, and also lists the current central authority that manages each. The original TLDs are highlighted in italics (I am including .INT as an original TLD since it was created long before the “new” ones earlier this decade). Figure 239 shows the fifteen generic TLDs in graphical form.

Table 166: Internet DNS Organizational (Generic) Top-Level Domains (Page 1 of 2)

Generic TLD	Abbreviation For	Authority	Current Use / Description
.AERO	Aerospace	Société Internationale de Télécommunications Aéronautiques (SITA)	Members of the aerospace industry, such as airlines and airports. (Yes, that <i>is</i> French!)
.ARPA	Address and Routing Parameter Area	Internet Assigned Numbers Authority (IANA) / Internet Corporation for Assigned Names and Numbers (ICANN)	First defined as a temporary domain for migration from the older host table system, the “ARPA” of course originally stood for the Advanced Research Projects Agency, creators of the predecessors of the Internet. Today, the .ARPA domain is used for internal Internet management purposes; the abbreviation at left was, I believe, “manufactured” to fit the letters “ARPA”. ☺ The best-known use of this domain is for reverse DNS lookups .
.BIZ	Business	NeuLevel, Inc.	Businesses. Intended as a competitor to .COM.
.COM	Commercial Organizations	VeriSign Global Registry Services	Originally intended for corporations and other commercial interests, .COM is also widely used for other purposes, including small businesses and even individuals who like the popularity of the .COM domain.
.COOP	Cooperative Associations	Dot Cooperation LLC	Cooperative associations.
.EDU	Education	Educause	Originally intended for all types of educational organizations, now used only for degree-granting higher education institutions accredited in the United States. Other educational institutions such as public schools usually use the country code TLDs.
.GOV	Government	US General Services Administration	Reserved for the United States federal government.
.INFO	Information	Afilias Limited	A very generic TLD designed for information resources of various sorts. It is unrestricted, in that anyone can register any sort of organization in .INFO. Also positioned as an alternative to .COM.
.INT	International	IANA .int Domain Registry	Used only for large organizations established by international treaty.

Table 166: Internet DNS Organizational (Generic) Top-Level Domains (Page 2 of 2)

Generic TLD	Abbreviation For	Authority	Current Use / Description
.MIL	Military	US DoD Network Information Center	Reserved for the United States military.
.MUSEUM	Museum	Museum Domain Management Association	Take a guess. ☺
.NAME	Names	Global Name Registry	In the original generic hierarchy there was no place set aside for individuals to register names for themselves, so people would instead create domains like "jonesfamily.org". This was non-ideal so .NAME was created as a place for individuals and families to register a domain for their names. .NAME also competes with the country code TLDs.
.NET	Network	VeriSign Global Registry Services	This TLD was supposed to be used only for Internet service providers and other organizations working intimately with the Internet or networking. Due to the exhaustion of name space in .COM and .ORG, many .NET domains are registered to other organizations, however.
.ORG	Organizations	Public Interest Registry	Originally intended for organizations not fitting into the other generic TLDs, .ORG quickly became associated with professional and non-profit organizations. It is possible, however, to have a for-profit company use a .ORG name.
.PRO	Professional	RegistryPro	Reserved for credentialed professionals such as lawyers and doctors.

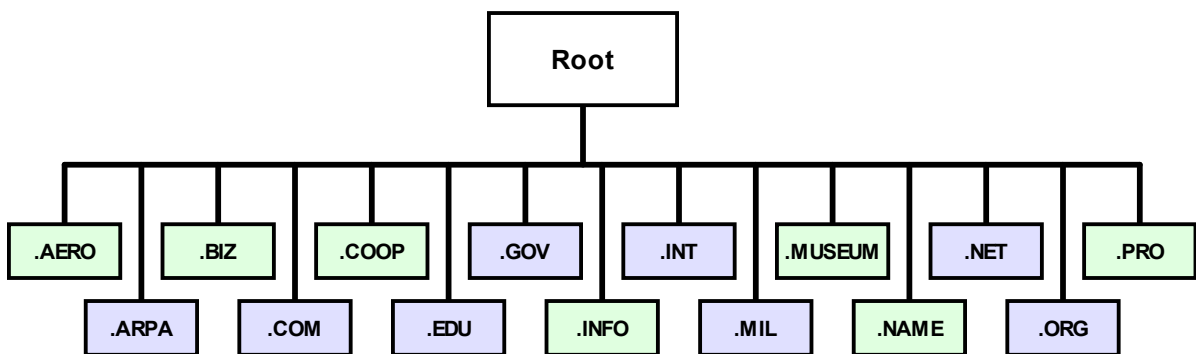

Figure 239: Internet DNS Organizational (Generic) Top-Level Domains (TLDs)

There are fifteen generic TLDs currently defined for the Internet. They have been shown here in alphabetical order, with the original TLDs shown in blue and the new ones added in 2001/2002 in green.



Key Concept: One of the two ways in which the Internet's DNS name space is divided is using a set of *generic* top-level domains. These TLDs are intended to provide a place for all companies and organizations to be named based on their organization type. There were originally six such domains, but this has been expanded so that there are now fifteen.

DNS Geopolitical (Country Code) Top Level Domains and Authorities

In theory, the [generic top-level domains \(TLDs\)](#) would be sufficient to meet the needs of all the individuals, companies and groups in the world. This is especially true since .ORG by definition is a “catch all” that can include anyone or anything. However, back at the beginning of DNS, its creators recognized that the generic TLDs might not meet the needs of everyone around the world. There are several reasons for this, chief among them:

- ☉ **Americentrism of the Generic Domains:** I don't mean this as a criticism (I'm an American citizen and love my country!) It is indisputable, however, that United States organizations and companies dominate the generic TLDs. This is not surprising, given that the Internet was first developed in the U.S.A., but it still presents a problem for certain groups. For example, if the United States military controls the .MIL domain, where does, say, Britain's military fit into the name space?
- ☉ **Language:** Most of the generic domains are populated by organizations that primarily do business in English. There are hundreds of languages in the world, however, and it's easier for the speakers of those tongues if they can more readily locate resources they can understand.
- ☉ **Local Control:** Countries around the world rarely agree on much, and they certainly differ on how organizations within their nations should have their Internet presence arranged. There was a desire on the parts of many to allow nations to have the ability to set up subsets of the name space for their own use.

Geopolitical (Country Code) Top Level Domains

For these and other reasons, the Internet's name space was set up with a set of *country-code* top-level domains paralleling the generic ones, sometimes called *ccTLDs*. I call these *geopolitical* TLDs since they are based on geopolitical divisions of the world (similar to [the example I used in my overview of the DNS name space](#)). In this hierarchy, every country of the world is assigned a particular two-letter code as a top-level domain, with a specific authority put in charge of administering the domain. For example, the ccTLD for Great Britain is “.UK”, the one for Canada “.CA” and the one for Japan is “.JP”. The codes often are more meaningful in the local language than in English, incidentally; Germany's is “.DE” and Switzerland's “.CH”.

Designating Countries and Country Code Letters

When I said that countries rarely agree on anything, I wasn't kidding—in fact, they can't even agree on what's a country! Real shooting wars have been fought over whether or not a particular territory was independent or part of another nation, never mind verbal wars, and the creators of DNS wanted no part of this sort of controversy. As the IANA web site says:

“The IANA is not in the business of deciding what is and what is not a country, nor what code letters are appropriate for a particular country.”

To remain neutral, IANA's ccTLD codes are taken directly from the standard country abbreviations maintained by the *International Organization for Standardization (ISO)* in ISO standard 3166-1. When a country is recognized by the ISO and a code assigned to it on this list, IANA creates it as a top-level domain. There are presently over 200 different geopolitical TLDs. No, I am **not** putting them here in a table, I have to draw the line somewhere around here! ☺



On The Web: You can find the current list of IANA country code TLDs at: <http://www.iana.org/cctld/cctld-whois.htm>

Country Code TLD Authorities

Each country has the authority to set up its TLD with whatever internal substructure it chooses; again, this is the power of a hierarchical structure. Some countries enforce a further geographical substructure at the lower levels. For example, the .US domain for the United States was originally set up so that all second-level domains were two-letter state abbreviations (this was later changed). Other countries may actually use organizational subdomains within their country code; Great Britain for example has .CO.UK for companies in their country (like .COM but for the UK only; they left off the “M”), and .COM.AU is for corporations in Australia. Other countries may not have any particular substructure at all, especially if they are small.



Key Concept: Due to the limitations of the generic TLDs, a set of *country code* top-level domains was created. This *geopolitical* hierarchy allows each nation on earth to set up its own name system based on its own requirements, and to administer it in the manner it sees fit. The IANA determines what is a country based on official decisions made by ISO.

Leasing/Sale of Country Code Domains

Interestingly, some very small countries with recognizable codes, especially to English speakers, have used their codes for very creative purposes, including selling or renting the name space to enterprising companies. A good example is the .TV domain, which techni-

cally belongs to the island nation of *Tuvalu*. Of course, to most people, “TV” means something quite different. Some folks thought that domain names ending in “TV” might be popular in the English-speaking world, so they formed a company called “The .TV Corporation” and negotiated with the government of Tuvalu to use the .TV domain. Today, the authority for this TLD is in fact this corporation, headquartered in California! Similar arrangements can be found with the .CC, .NU, .TO and other TLDs.

This serves as a good reminder that the name space is logical and not physical. Obviously, the many computers with “.TV” names are not actually located on a remote island in the South Pacific. Similarly, if a Web site ends with “.CA”, for example, it probably represents a Canadian organization, but that doesn’t necessarily mean the Web site itself is actually hosted in Canada.

Drawbacks of the Geopolitical TLDs

The geopolitical domains have been very popular for certain uses; for one thing, national governments and other “official” institutions like to use them, for obvious reasons. Typing “www.gov.XX” or “www.government.XX” where “XX” is a country code is likely to bring you to the national government Web site of most countries. Some companies and organizations use the ccTLDs because they allow them to choose a name already taken in the generic hierarchies, or simply to express national pride.

For many other companies and organizations, however, the generic TLDs have been much more popular than the country codes. I believe there are several reasons for this, but I think the most important one is that organizations are easier to locate using the generic domains.

Here's a good example of what I mean. In the town near where I live, a new grocery store called Aldi recently opened. I like the store and wanted to learn more about them, so I fired up my Web browser and sought out their Web site. Yes, I could have typed it into a search engine, but like most people I am lazy. It was much easier to just enter “www.aldi.com” into my browser, and lo and behold, up popped the web site of Aldi International.

Now, Aldi is actually headquartered in Germany, and they do have a web site at “www.aldi.de” as well. But I had no idea where they were originally from. I found them easily by going to “www.aldi.com”, because I didn’t need to know their physical location, and because I know that most large companies have a “.COM” domain. Of course, being “findable” is very important, especially for commercial organizations trying to do business.

Another good example is the United States, which as mentioned above has its own country code, .US, in addition to dominating the generic TLDs. The authority in charge of this domain chose to make it follow a strict geographical hierarchy, so every domain must be of the form “organization.city.state-code.US”. So, to use this part of the name space, a company in Boston must be within the “.boston.ma.us” domain.

That's very neat and logical, but it makes names both longer and harder to guess than the generic equivalents. Suppose you wanted to get information on metals giant Alcoa. If you're in the industry you might know they are located in Pittsburgh, but if not, which is easier to find, “www.alcoa.pittsburgh.pa.us”, or “www.alcoa.com”? Anyone here know how to spell Albuquerque? ☺

It is for this reason that the .US domain achieved success in certain segments of society but not in others, especially commercial entities (corporations). The strict hierarchy does have some real advantages, however, such as avoiding [name space conflicts](#). The .US authority eventually abandoned the strict geographical hierarchy due to its non-acceptance.

DNS Second-Level and Lower Domains, Delegation of Registration Authority and Public Registration

The IANA is in charge of deciding what top-level domains (TLDs) exist in the Internet name space, and as such, they are ultimately responsible for all names in the Internet. The entire point of the [authority hierarchy](#), however, is that IANA not be responsible for the whole name space. So, while IANA maintains control over certain TLDs, such as [.INT](#) and [.ARPA](#), control for managing the others is delegated to secondary authorities for each TLD.

Just as IANA had the choice of how to delegate authority to the subdomains of the “root” domain, the organization in charge of each TLD gets to make the same decision about how second-level domains are to be created under the TLD. In many of the TLDs, especially the generic ones, second-level domains are assigned directly to individuals or organizations.

For example, a company named XYZ Industries might want to get the domain “xyzindustries.com”. In other TLDs, second-level domains are set up in a particular structure, like the state codes used in the .US domain. There, you need to go down more levels, but eventually you once again get to the point where companies and people register their own domains; in the .US domain, XYZ Industries might want to register “xyz.phoenix.az.us”, for example, if they were headquartered in Phoenix.

Centralized Public Registration

This transition point between the authorities granted responsibility for parts of the name space and the “regular” people and groups who want to get names within it is important. A process of *public registration* had to be established to allow such name assignment to occur in a consistent and manageable way. This was not that difficult to accomplish back when the original [generic TLDs](#) and [country code TLDs](#) were first created. The Internet was quite small and it made sense to just have the authority in charge of each TLD perform registrations within that TLD. This ensured that there was no duplication of names within a TLD with a minimum of fuss.

For the very important generic TLDs such as .COM, .NET and .ORG, the authority in charge of registration was the *Internet Network Information Center (the InterNIC)*. The InterNIC was set up as a service administered by the United States government, who later granted

the contract to manage it to *Network Solutions Inc. (NSI)*. NSI was eventually purchased by Verisign, then later spun it off as a separate venture. (Things change quickly in the networking world!)

NSI single-handedly performed all registrations within the .COM, .NET and .ORG TLDs for many years. The popularity of the original generic TLDs, however, led to an explosion in demand for name registration in the 1990s in these domains. Having a single company in charge of registration led to this becoming another bottleneck in the Internet's domain name system. There were also many folks who didn't like the lack of accountability and competition that came with having a single "monopoly" in charge of registration; the InterNIC could set its own price and originally charged \$35 per year per domain name, then later \$50 per year.

Deregulation of Public Registration

In the late 1990s, responsibility for name registration was given to the [Internet Corporation for Assigned Names and Numbers \(ICANN\)](#). The registration process was "deregulated", to borrow a term referring to removal of monopolies from industries like power generation. As of December 1999, there was still a single authority that has overall responsibility for each TLD, including .COM, .NET and .ORG. Today, Network Solutions is still the authority running .COM and .NET. However, they aren't the only ones that register names within these TLDs. They further delegate registration authority to a multitude of other companies, called *accredited registrars*. Any registrar can register names within the TLD(s) for which they are accredited.

Naturally, coordination becomes much more of a concern when you have multiple companies registering names in a TLD compared to just one. A special set of technical and administrative procedures is followed to ensure that there are no problems such as two registrars trying to grab a name at the same time. The system has worked well, and those who wish to use TLDs where competition exists now can choose from a variety of registering companies. The most noticeable result of this was also the most predictable one: the cost of registering a domain name in the deregulated generic TLDs is usually much lower than the fees originally charged by the InterNIC.

Once a company, individual or organization has a registered lower-level domain, he/she/it becomes the authority for that domain. Use of the domain then becomes private, but depending on how the domain is used, further public name registration may be required. [See the topic on private registration for more.](#)

DNS Public Registration Disputes (Conflicts, Cybersquatting, "Deceptive Naming", Etc.) and Dispute Resolution

The Internet started off as a medium for research into networking, evolved into a system for interconnecting scientists and ended up as a global communications tool used by just about everyone. As part of this evolution, the Internet also became a very important part of how business is done in the world. Money started to really come into the Internet picture in the

early 1990s, and just a few short years later, its impact on the Internet was so significant that the growth of the stock market to dizzying heights in the late 1990s is now often called “the Internet bubble”.

Public Registration Disputes

Unfortunately, the increasing importance of the Internet to commercial interests crashed headlong into the non-commercial original design of Internet technology, and nowhere was this more evident than in the Domain Name System. Since there were only a few [generic TLDs](#), since each name within a TLD had to be unique, and since humans are often confrontational creatures, it didn't take a long time before arguments broke out over who should be able to use what name, and why. And of course, from there, it didn't take long before lawsuits and other unpleasanties broke out.

There are a surprising number of significant problems associated with public registration of domain names.

Corporate Name Conflicts

The .COM domain is for corporations, but many corporations have the same name. The ACME Furniture Company, the ACME Restaurant Supply Corporation and ACME Footwear, Inc., probably all would like to have the “acme.com” domain. But there can be only one such domain within .COM. (These are fictional examples; “acme.com” is in fact owned by an organization called *Acme Labs*.)

Corporate/Individual/Small-Business Name Conflicts

There are many corporations that have names similar to or even identical to the names of individuals, leading to potential conflicts. For example, suppose your first name is Wendy and you own a small fabric store called “Wendy's Fabrics”. But you are Internet savvy and decide you want to register “wendys.com” as soon as you hear about the Internet in 1993. Then this big hamburger chain comes along and has a problem with that... ☺

To my knowledge no such issue arose with respect to Wendy's, but there actually was a widely-publicized case that shows just how recently most corporations were “out of the loop” with respect to domain naming. In 1994, a writer for Wired magazine was astonished to find that the “mcdonalds.com” domain name was unregistered! To show just how unregulated the registration process was, he registered it himself, and caused a bit of a stir as a result. The Golden Arch Folks eventually acquired the domain from him in an amicable arrangement where he relinquished the name and they made a donation to charity.

“Corporate Warfare”

A particularly ugly type of conflict is sometimes seen where companies intentionally try to take business from each other by registering names that have nothing to do with their own companies. An example would be if Burger King had tried to register “mcdonalds.com” and use it to advertise Burger King products. (Which they *didn't* do, I might add, so please nobody sue me! ☺)

Another example is when companies try to use alternate TLDs, such as registering “burgerking.org” to confuse people trying to find “burgerking.com”. In fact, many companies have taken the step of registering their names in many different TLDs to prevent this sort of thing from happening.

“Cybersquatting”

Some ambitious (to choose a nice term) individuals, recognizing early on the potential value of certain names, registered large volumes of names with the hopes of reselling them. Many people condemned this as exploitative, and the term *cybersquatting* was created to refer to this type of activity. Unfortunately, a lot of money was made this way, and there are many domain names that to this day cannot be used because they have been “reserved” indefinitely by people or individuals who will never use them.

Deceptive Naming Practices

Another type of somewhat-diabolic creativity has been displayed by people who seek to take advantage of the inability of some of us to spell. For example, if you were a competitor of a large company called Superb Transceivers Inc., which registered “superbtransceivers.com”, you might register “superbtranscievers.com” and redirect traffic from there to your own domain. Another example takes advantage of the common mix-up between “O” (the letter) and “0” (the number). For example, a software company once registered “micros0ft.com”, much to the chagrin of the Redmond, Washington software giant.

Dispute Resolution Methods

So, how do we resolve these situations? As the saying goes, it can be done either the easy way, or the hard way...

Domain Name Sharing

Sometimes the antagonists agree on a productive solution. One particularly constructive idea is to agree to *share* the domain name. For example, the three ACME companies mentioned in my example above could each create their own more-specifically-named domains, such as “acmefurniture.com”, “acmerestaurantsupply.com” and “acmefootwear.com”. Then, they might agree to have the “www.acme.com” registered to nobody, by having one company register it and not use it for anything.

Even better, they could set it up with a simple web page that says the domain is shared, with a link to the three sites above. I have seen this before, but rarely. Unfortunately, it seems grade school children understand the concept of sharing better than most corporate executives do.

Domain Name Purchase

Another option is purchase. If a big company wants a domain name already registered by an individual or small business, they will often just purchase it, as this is the easiest thing to do. During the height of the Internet mania, there were domain names that sold for *millions* of dollars—just for the right to use the name! Again, many cybersquatters and other speculators got rich doing this.

Litigation

Often the combatants don't play nice, and the usual occurs: threats, intimidation, law suits, and so forth. Sometimes a letter from a lawyer is enough to resolve the issue, especially when some poor individual owning a web site gets threatened with legal action by a large company—this has happened many times.

However, often the disagreeing parties stick to their guns, especially if two companies lock horns and their lawyers refused to back down. Usually the matter then ends up in the courts, and is eventually be resolved one way or the other. This gets into legal issues that I am totally unqualified to even talk about. Usually, claims of trademark infringement would be used by a company challenging a prior domain name registration.

The Uniform Domain Name Dispute Resolution Policy

Lawsuits are expensive and time consuming, so there was a desire that some other mechanism exist for resolving these conflicts as well. Since the authority for each TLD controls what happens within it, it also has the right to create its own policies for how to deal with these sorts of issues. For the generic TLDs, the original registering authority, the InterNIC, had a dispute resolution policy that allowed someone with a complaint to challenge a domain name registration if they had a trademark interest in that name. The policy was controversial for a number of reasons, not the least of which because it led to some domain names being successfully challenged even if there was no proof of trademark infringement.

The current authority for the generic TLDs, [IANA/ICANN](#), created a new *Uniform Domain Name Dispute Resolution Policy (UDRP)* in 1999, to better handle domain name conflicts. This policy specifies a procedure whereby a company that has a valid trademark can challenge a domain name if it either infringes on the trademark, is confusingly similar to it, or if the name was registered by someone else in bad faith. At the same time, it also lists ways that the original registrant can prove that the registration is valid and should be maintained. This new system eliminates many of the real problems described above, such as deceptive naming, “corporate warfare” and cybersquatting, while not automatically allowing a second-comer to shut down a legitimate domain.

Disputes as a Motivation for New Generic TLDs

Incidentally, it was all this nonsense that led, in part, to the clamor for new generic top level domains. In the interest of fairness, I also want to mention that even though more complicated TLDs like the old strictly hierarchical .US are not very popular, they have a **huge**

advantage over the generic domains. Since all registrations there are geographic, there are far fewer conflicts, because a dispute requires that two organizations have the same name and also be in the same state and town.

For example, you could still have three “Joe's Pizza Parlor”s in Chicago duke it out, but it's not likely that you'd see big companies on the mat in .US. For example, the ACME Furniture Company might use “acme.seattle.wa.us”, the ACME Restaurant Supply Corporation “acme.mendocino.ca.us” and ACME Footwear, Inc. could go with “acme.anchorage.ak.us”.

DNS Name Space Administrative Hierarchy Partitioning: DNS Zones of Authority

I explained earlier in this topic that the DNS name space is arranged in a hierarchy, and that there is also a [hierarchy of authorities that is related to that hierarchical name structure](#). However, the two hierarchies are *not* exactly the same. The reason is that if they were the same, this would mean we needed a separate authority for every domain at every level of the tree, and that's something we are very unlikely to want to have everywhere in the structure.

At the very top levels of the DNS tree, it seems reasonable that we might want to designate a separate authority at each level of the structure. Consider the [geopolitical name hierarchy](#); IANA/ICANN manages the “root” domain, but each of the ccTLDs is managed by a distinct national authority

The Need For Authority Hierarchy Partitioning

However, when you get to the lower levels of the structure, it is often inconvenient or downright impossible to have each level correspond to a separate authority. As an example, let's suppose you are in charge of the Googleplex University IT department, which runs its own DNS servers for the “googleplex.edu” domain. Suppose there were only two schools at this university, teaching Fine Arts and Computer Science. Suppose also that the name space for the computers were divided into three subdomains: “finearts.googleplex.edu”, “compsci.googleplex.edu”, and “admin.googleplex.edu” (for central administrative functions, including the IT department itself).

Most likely, you don't want or need the Fine Arts department running its own DNS servers, and they probably don't want to, either. The same is likely true of the administration machines. However, it's possible that the Computer Science department *does* want to run its own DNS servers, because they probably have many more computers than the other departments, and they might use running a DNS server as part of their curriculum. In this case, you might want yourself, the administrator for “googleplex.edu”, to maintain authority for the “finearts.googleplex.edu” and “admin.googleplex.edu” subdomains and everything within them, while delegating authority for “compsci.googleplex.edu” to whomever in the Computer Science department is designated for the task.

DNS Zones of Authority

DNS is specifically designed to allow these divisions between the name hierarchy and the authority structure to be created. The complete DNS name structure is divided by making *cuts* (as the standard calls them) between adjacent nodes to create groups of contiguous nodes in the structure. Each group is called a *zone of authority*, or more commonly, just a *zone*. Each zone is usually identified by the domain name of the highest-level node in the zone, that is, the one closest to the root. The zones in DNS are by definition *non-overlapping*—every domain or subdomain is in exactly one zone.

Methods of Dividing the Name Space Into Zones

The division of the name space into zones can be made in an arbitrary way. At one extreme, we could place a cut between every node, and thereby divide the entire name space so each domain (and subdomain, etc.) was a separate zone. If we did this, the name hierarchy and authority hierarchy would indeed be the same for the entire DNS tree. At the other end of the scale, we could use no cuts at all, defining a single zone encompassing the entire DNS structure. This would mean the root was the authority for the entire tree.

Of course in practice, neither of these is particularly useful, as neither really reflects how the real-world administration of DNS works. Instead, we generally divide the name structure in a variety of places depending on the needs of different parts of the name space. There are many cases where we might want to create a subdomain that is responsible for its own DNS server operation; there are others where we might not want to do that. The significance of a “cut” in the name hierarchy is that making such a cut represents, in essence, a *declaration of DNS independence* by the node below the cut from the one above the cut.

Returning to our example, if googleplex.edu is in charge of its own DNS servers, then there would be a “cut” in the name space between “googleplex.edu” and .EDU at the next higher level. This means that the DNS server for .EDU is no longer in charge of DNS for the “googleplex.edu” domain; instead, either the University itself or someone they hire as a third party must provide DNS for it. In this case, we are assuming Googleplex U. themselves run their own DNS. Without making any other cuts, the “googleplex.edu” domain would be a single zone containing everything below that name, including both “finearts.googleplex.edu” and “compsci.googleplex.edu”.

In our example, however, we would make another “cut”, between “googleplex.edu” and “compsci.googleplex.edu”. This in effect *liberates* “compsci.googleplex.edu”, allowing its administrators to be in charge of their own DNS server. In so doing, we end up with two distinct zones: one encompassing “googleplex.edu”, “finearts.googleplex.edu” and “admin.googleplex.edu” (and everything underneath them) and another for “compsci.googleplex.edu” (and everything below it). This is illustrated in [Figure 240](#).



Key Concept: The DNS name registration hierarchy is divided into regions called *zones of authority*. Each zone represents an area that is administered independently, and consists of a contiguous segment of the DNS name tree.

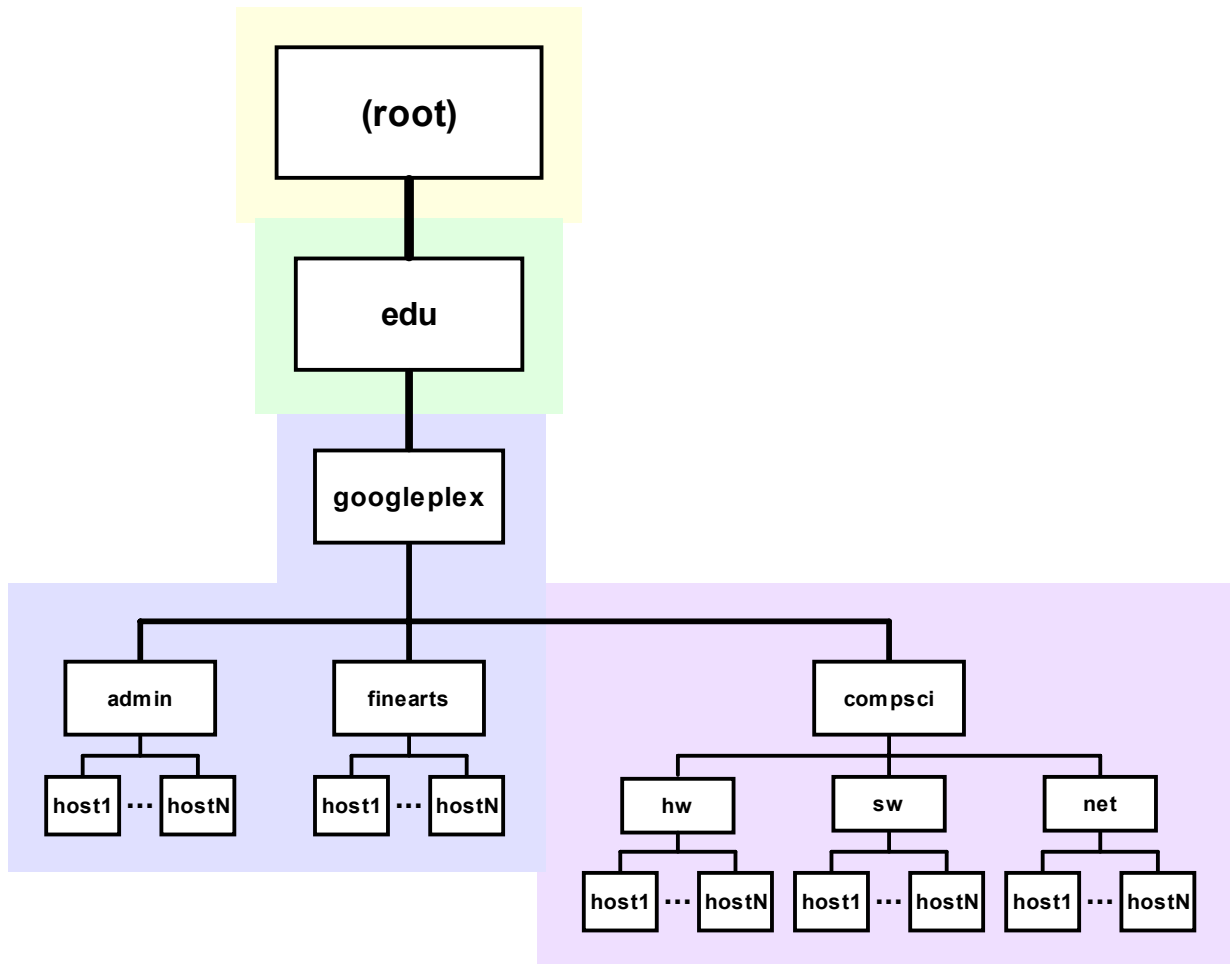

Figure 240: DNS Zones Of Authority

This example shows how *cuts* can be made between nodes in the DNS name tree to create an arbitrary hierarchy of name authorities. In this example I have shown the DNS tree branch for “googleplex.edu”, with each zone indicated using a different background color. IANA/ICANN is responsible for the root domain (yellow), and a separate authority named *Educause* takes care of “.EDU” (green). The blue zone covers much of “googleplex.edu”, except that a cut has been made between “googleplex” and “compsci” to create an independent zone of authority for “compsci.googleplex.edu”, shown in purple.

The Impact of Zones on Name Resolution: Authoritative Servers

The concept of zones is critical to understanding how DNS name servers work, and therefore, how name resolution is performed. All of the information about the subdomains and individual devices in the zone is represented using a set of resource records stored on a DNS name server. Usually, this name server is associated with the highest-level domain name in the zone. A name server that contains the definitive information for the zone is said to be *authoritative* for the zone. An authoritative server for a zone is one that maintains the official information about the zone, and the one that is ultimately responsible for providing name resolution information about it. We'll see more about this in [the section on DNS servers and name resolution](#).

Every DNS zone has a set of authoritative servers, which are usually a pair called the *primary* (or *master*) and *secondary* (or *slave*) servers. However, it is also possible for a single DNS name server to be authoritative for more than one zone. As mentioned above, it is not always necessary for the actual owner of a domain to provide DNS services for it. Very often, especially for the domains owned by small businesses or individuals, DNS services are provided by a third party, often an Internet Service Provider.

For example, I have had “pcguide.com” registered as a domain since 1997, but my long-time Web hosting provider, pair Networks, has provided DNS services for me since the beginning. This means that pair's DNS servers in the “pair.com” hierarchy are responsible for “pcguide.com”. They are also responsible for many other domains for their customers.

DNS Private Name Registration

We have now seen [the hierarchical nature of the DNS name space](#), and [the authority structure](#) that administers it. Name registration begins with the [generic](#) and [country code](#) top-level domains (TLDs) within the root of the name hierarchy, proceeds to [second-level domains](#) within the TLDs, and then lower-level subdomains below those. As we progress down the name tree, we move from the most general, public authority (IANA/ICANN, which runs all of DNS), through the high-level TLD authorities, and eventually down to the level of individual organizations, corporations and individuals.

Private Domain Name Ownership

This “dividing line” between public authorities and private authorities occurs in many different places in the name structure. Wherever it does occur, below that line, responsibility for the domain becomes that of the organization that registered it. It can further subdivide the name space, granting parts of it to other organizations or even reselling it if they wish. Alternately, they may decide to use the name space to create a purely internal structure. I call this *private name registration*, in contrast to the *public name registration* we discussed earlier in this section.

For example, if a company called XYZ Industries registers “xyzindustries.com”, they become the owner of not just that domain name, but any subdomain structure or named items within it that they may choose to create. This is, of course, the beauty and power of authority delegation and the hierarchical structure. The company has an important decision that they must make however: they must choose whether they want to create names that are part of the global DNS name structure, or if they want to use names within the structure purely privately.

Using Publicly-Accessible Private Names

If a company wants names within its domain to be part of the global DNS name structure, it is required to perform the work necessary to properly set up and manage these names so they fit into the Domain Name System. The most common example, of course, is creating a public World Wide Web server. Most companies name such servers beginning with “www”, so XYZ Industries would probably wish to have the name “www.xyzindustries.com” for its WWW server address.

Obviously, they want and need anyone on the Internet to be able to locate this server. Thus, even though XYZ has private control of the “xyzindustries.com” domain, and thus owns the name “www.xyzindustries.com”, they must follow proper procedures for ensuring that DNS resource records are set up for their “www” subdomain so everyone on the Internet can find it. They may do this themselves, if they run their own DNS servers, or may have an ISP or other third party do it for them, as described in the [previous topic](#).

Using Private Names For Internal Use

The alternative is to create “purely private” names for use only within the organization. For example, it is likely that even if XYZ wants a public Web server, it may wish to name many other machines that are to be accessed only within the company itself. In this case, they don't need to set these machines up so they are publicly recognizable. They can create private machine names and manage them internally within their own network.

One common way in which this is done is to make use of the older host table name system. This system is now archaic for large internetworks, but is often still used in smaller companies due to its simplicity. A name is “registered” by being added to the host tables on each of the computers within the organization, and “resolved” when the operating system on a host checks this file prior to using standard DNS resolution methods. The host table supplements DNS in this case (it is not really a part of DNS.) The two systems are complements and can work together, as I explained at the end of [the topic describing host tables](#).



Key Concept: Once an organization registers a particular domain name, it becomes the owner of that name and can decide whether and how to create a substructure within that domain. If it wants objects in the domain to be accessible on the public Internet, it must structure its domain to be consistent with Internet DNS standards. Alternately, it can create a purely private domain using any structure and rules it prefers.

Using Private Names On Networks Not Connected to the Internet

If you are running a “purely private” network not connected to the Internet at all, you can actually set up your own entirely private name hierarchy and run DNS yourself. In this case, you become “the boss” in charge of the DNS root and can use any naming system you like. This is sometimes considered attractive, because one can then use very simple machine names on small networks, without having to perform any public registration or even use names that correspond to the global hierarchy. Instead of the accounting computer in XYZ Industries being named “accounting.xyzindustries.com”, internally it could be named just “accounting”. You can mix these with real DNS names too when accessing resources, so Joe's machine could be called just “joe”, while the Web site of UPS would of course still be “www.ups.com”.

The most common example of this mixing of private and public names is the definition of the private local name for the loopback address of a computers. Most Windows and UNIX machines define the name “localhost” to be the address 127.0.0.1, which means “this computer” on any TCP/IP machine.



DNS Name Servers and Name Resolution

The preceding two sections describe the Domain Name System's hierarchical name space, and the authorities that manage it and are responsible for name registration. These two elements, the name space and name registration, are the more “intangible” parts of the name system, which define how it is created and managed. The “tangible” aspect of the name system is the set of software and hardware that enables its primary “active function”: *name resolution*. This is the specific task that allows a name system to replace cumbersome numeric addresses with easy-to-use text names.

Name resolution is the part of DNS that generally gets the most attention, because it is the portion of the system that most people work with on a daily basis. DNS uses a very capable client/server name resolution method that makes use of a distributed database of name information. The most commonly used implementation of the DNS name resolution process is, of course, the one used for the Internet itself, which resolves many billions of name requests every day.

In this section I explain in detail the concepts and operation of the DNS name resolution function. The section is broken into three subsections. The first two cover each of the two key software elements that work together to implement the DNS client/server name resolution function. The first describes DNS name servers, and how they represent, manage and provide data when resolution is invoked. The second describes DNS clients, called *resolvers*, how they initiate resolution, and the steps involved in the resolution process. After these I have a third subsection that ties together the information about name servers and resolvers by providing a look at message exchange between these units, and describing the formats of messages, resource records and DNS master files.



Background Information: The material in this section assumes that you are already familiar with the topics in the preceding two sections, and references those sections where appropriate. If you have not already read the sections on the [DNS name space](#) and [name registration](#), you should at least review the [overview of DNS components and general functions](#).



Related Information: A set of related TCP/IP utilities called *nslookup*, *host* and *dig* can be used by an administrator to query DNS name servers for information. They are useful for a variety of purposes, including manually determining the IP address of a host, checking for specific resource records maintained for a DNS name, and verifying the name resolution function. [See the topic discussing these programs in the section on TCP/IP administration utilities.](#)

DNS Name Server Concepts and Operation

Of all the components and functional elements that combine to form the Domain Name System, DNS *name servers* are arguably the most important. These servers, which may be either dedicated devices or software processes running on machines that also perform other tasks, are the workhorses of DNS. They store and manage information about domains, and respond to resolution requests for clients—in some cases millions of times each day. Understanding how they perform both this most basic task and the many support jobs for which they are also responsible is crucial to understanding DNS as a whole.

In this section I describe the concepts related to DNS name servers, and explain how they operate. I begin with an overview of DNS name server functions and general operation. I describe the way that DNS name server data is stored in resource records and the role of classes. I discuss the different roles of name servers in DNS, and explain the all-important root name servers. I discuss how DNS zones are managed, the notions of domain contacts and zone transfers, and how caching and load balancing are used to improve efficiency in DNS. I conclude with a brief outline of two enhancements to basic DNS server operation, using the new *Notify* and *Update* message types, as well as incremental zone transfers.



Related Information: The information in this section should be considered complementary to that in [the following section on DNS resolvers](#).

DNS Name Server Functions, Name Server Architecture and General Operation

The [three major functions of a name system](#) are creating a name space, performing name registration and providing name resolution services. We've seen earlier in this larger section on the Domain Name System that DNS uses a [hierarchical tree structure for its name space](#), and also a [hierarchical tree for name authorities and registration](#). I'm sure that, given this, you will have to struggle to contain your surprise when I tell you that name resolution is also oriented around the notion of a hierarchical structure.

The devices that are primarily charged with performing the functions required to enable name resolution are *name servers*. They are arranged in a hierarchy that is closely related to the authority structure of the name system. Just as the authority structure **complements** the name structure but is not exactly the same as it, the name server architecture complements both the authority structure and the name structure, but may be different in its actual composition from both.

DNS Name Server Architecture and the Storage of the Distributed Name Database

In a large DNS implementation, information about domains is not centralized in a single database run by one authority. Instead, it is *distributed* across many different authorities that manage particular top-level domains (TLDs), second-level domains or lower-level subdo-

mains. In the case of the global Internet, literally millions of different “authorities”, many of them responsible only for their own local domain space, participate cooperatively in running the DNS system.

With authority for registration distributed in this manner, this means that the information about domains is similarly spread amongst many entities, resulting in a *distributed database*. A key concept in DNS name resolution is that each entity that maintains responsibility for a part of the name space must also arrange to have that information stored on a DNS server. This is required so that the server can provide the information about that part of the name space when resolution is performed. As you can see, then, the existence of a structured hierarchy of authorities directly implies the need for a hierarchy of servers that store that hierarchical name information.

Each DNS [zone of authority](#) is required to have one or more DNS servers that are “in charge” of managing information about that zone. These servers are said to be *authoritative* for the zone. Storing information about the domains, subdomains and objects in the zone is done by recording the data in special [resource records that are read from DNS master lists](#) maintained by administrators. Servers then respond to requests for this information.

Since information in DNS is stored in a distributed form, there is no single server that has information about every domain in the system. As we'll see in [the section on name resolvers](#), the process of resolution instead relies on the hierarchy of name servers described just above. At the top of the DNS hierarchy is the *root* domain, and so we also see there the [root name servers](#). These are the most important servers, because they maintain information about the top-level domains within the root. They also have knowledge of the servers that can be used to resolve domains one level below them. Those servers in turn are responsible for the TLDs and can reference servers that are responsible for second-level domains. Thus, a DNS resolution may require that requests be sent to more than one server.



Key Concept: DNS public name information is stored in a *distributed database* of DNS *name servers* that are structured in a hierarchy comparable to the hierarchy of authorities. Each zone has one or more DNS name servers in charge of the zone's information, called *authoritative* name servers.

DNS Server Support Functions

The storing and serving of name data (through responses to requests from DNS resolvers) is the main function of a DNS server. However, other support jobs are also typically required of a DNS server, including the following:

- ☉ **Interacting With Other Servers:** As mentioned above, the DNS resolution process often requires that multiple servers be involved. Servers must thus maintain not just name information, but information about the existence of other servers. Depending on the type of DNS request, servers [may themselves become clients and generate requests to other servers](#).

-
- ☉ **Zone Management and Transfers:** The server must provide a way for [DNS information within the zone to be managed](#). A facility also exists to allow a *zone transfer* to be performed between the master (primary) server for a zone and slave (secondary) servers.
 - ☉ **Performance Enhancement Functions:** Due to the large number of requests servers handle, they employ numerous techniques to reduce the time required to respond to queries. The most important of these is [caching of name information](#). A variation of regular caching called *negative caching* may also be used to improve performance, and [load balancing](#) is a feature that can be used to improve efficiency of busy devices registered within the DNS system.
 - ☉ **Administration:** Various other administrative details are required of name servers, such as storing information about the different types of “[contacts](#)” (humans) who are responsible for certain tasks related to management of a domain or zone.

As we'll see later in this section, not all name servers perform all of the tasks described above in this topic; some perform only a subset.

The DNS Name Server Hierarchy is Logical, Not Physical

Like the other hierarchies, the name server hierarchy is **logical** in nature. I already mentioned that it often is not exactly the same as the authority hierarchy. For one thing, it is common for a single DNS name server to be the authoritative server for a number of domains. Even if a particular group has authority for a subdomain of a particular domain, it's possible they will “share” the DNS servers with the authority of their parent domain for efficiency reasons. For example, a university might delegate control over parts of its domain space to different groups (as in [our example in the topic on DNS zones](#)) but still manage all subdomains on the same server. In practice, the lower the level the subdomain in the DNS name hierarchy, the less likely that subdomain has its own DNS server.

Another important aspect of the logical nature of the name server hierarchy is that there is no necessary relationship between the structure of the name servers and their location. In fact, in many cases name servers are specifically put in different places for reliability reasons. The best example of this is the set of root name servers—despite all being at the “top” of the DNS server architecture, they are spread around the globe to prevent a single problem from taking all of them out. Also remember not to be fooled by the structure of a name in the [geopolitical DNS name hierarchy](#)—a name server called “ns1.blahblah.ca” might be in Canada, but it very well might not.



Key Concept: The DNS name server hierarchy is logical in nature and not exactly the same as the DNS name server tree. One server may be responsible for many domains and subdomains. Also, the structure of the DNS name server hierarchy doesn't necessarily indicate the physical locations of name servers.

DNS Name Server Data Storage: Resource Records and Classes

One of the most important jobs performed by name servers is the storage of name data. Since the authority for registering names is distributed across the internetwork using DNS, the database of name information is likewise distributed. An *authoritative* server is responsible for storing and managing all the information for the zones of authority it is assigned.

Each DNS server is, in essence, a type of database server. The database contains many kinds of information about the subdomains and individual devices within the domain or zone for which the server is responsible. In DNS, the database entries that contain this name information are called *resource records (RRs)*. A specific set of RRs is associated with each node within the zone.

Binary and Text Representations of Resource Records

The entire point of DNS is to allow humans to work with names and computers to work with numbers, and we see this principle further reflected in the two very different representations that exist for the DNS resource records themselves:

- ☉ **Resource Record Field Format (Binary) Representation:** Name servers are required to respond to queries for name information by sending resource records within DNS messages. Obviously, we want to do this in as efficient a way as possible, so each resource record is internally stored using a special field format that is similar to the many field formats we have seen used for messages in other protocols. All resource records use a general field format for some of their fields, and then have a unique portion that is specific to the resource record type.
- ☉ **Master File (Text) Representation:** Computers are happy to exchange binary-encoded field formats and have no problem remembering that, for example, resource record type 15 corresponds to a mail exchange (MX) record. However, human administrators want to be able to quickly and easily maintain DNS information without having to remember cryptic codes or work with binary values. For this reason, DNS uses a *master file* format for its user-machine interface, which allows resource records to be specified in text form for easier maintenance.

Use of Resource Records and Master Files

Each node may have a variable number of records, depending on the node type and what information is being kept for it. The resource records are added, changed or deleted when DNS information changes, by administrators who make modifications to the text master files on the server computer. These files are then read into memory by the DNS server software, parsed (interpreted) and converted into binary form. They are then ready for use in [resolving DNS name requests and other queries](#). This is illustrated in [Figure 241](#).

I describe both the binary RR field formats and master file format in [the section on DNS messaging and formats](#).

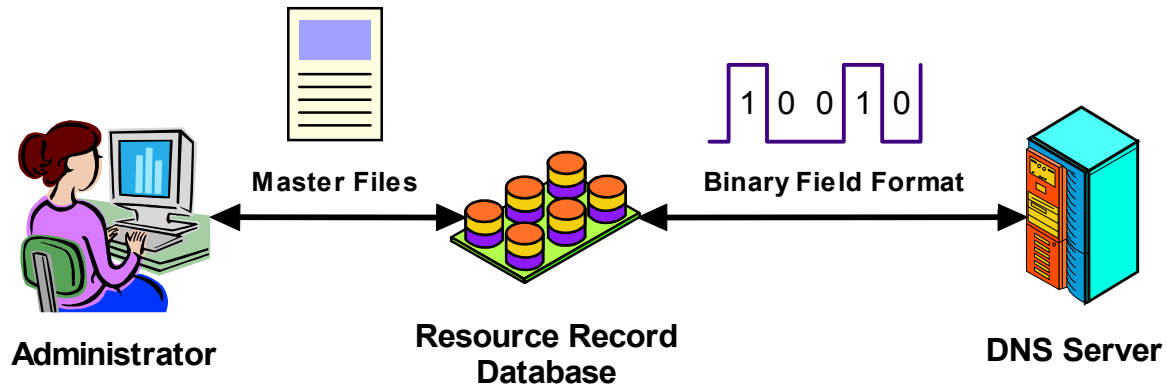

Figure 241: DNS Resource Record Master File and Binary Field Formats

To meet the needs of humans and computers, DNS uses two representations for the data stored in resource records. Administrators enter and maintain information in textual DNS master files. These are read by DNS server software and internally stored in binary format for answering DNS requests.



Key Concept: DNS name servers store DNS information in the form of *resource records (RRs)*. Each RR contains a particular type of information about a node in the DNS tree. There are two representations for resource records: conventional binary field formats are used for communication between DNS name servers and resolvers, while text *master files* are edited by administrators to manage DNS zones.

Common Resource Records Types

The main DNS standards, RFC 1034 and 1035, defined a number of resource record types. Over time, the list has changed, with new RR types being created in subsequent standards and the use of others changed. Like other Internet parameters, the list of DNS RR types is maintained in a file at [IANA](http://iana.org). Also like other Internet parameters, there are in fact several dozen defined RRs in DNS, but only a few are commonly used; others are now obsolete, used for special purposes or “experimental” in nature.



On The Web: The current list of DNS resource records is maintained in a file that can be found at: <http://www.iana.org/assignments/dns-parameters>

Table 167 summarizes the most important resource record types. For each, I have shown the numeric *Type* value for the record, which is used to identify the resource record type in message exchanges, and also the text code used for the RR in master files. I have also provided a brief description of each.

Table 167: Summary Of Common DNS Resource Records

RR Type Value	RR Text Code	RR Type	Description
1	A	<i>Address</i>	Contains a 32-bit IP address. This is the “meat and potatoes” of DNS, since it is where the address of a node is stored for name resolution purposes.
2	NS	<i>Name Server</i>	Specifies the name of a DNS name server that is authoritative for the zone. Each zone must have at least one NS record that points to its primary name server, and that name must also have a valid <i>A (Address)</i> record.
5	CNAME	<i>Canonical Name</i>	This resource record is used to allow aliases to be defined that point to the real name of a node. The <i>CNAME</i> record provides a mapping between this alias and the “canonical” (real) name of the node. The <i>CNAME</i> resource record is commonly used to hide changes in the internal DNS structure from outside users, by letting them use an unchanging alias while the internal names are modified based on the needs of the organization. See the topic on name resolution for an example.
6	SOA	<i>Start Of Authority</i>	The SOA resource record is used to mark the start of a DNS zone and provide important information about it. Every zone must have exactly one SOA record, which contains details such as the name of the zone, its primary (master) authoritative server name, and technical details such as the e-mail address of its administrator and parameters for how often slave (secondary) name servers are updated.
12	PTR	<i>Pointer</i>	Provides a pointer to another location in the name space. These records are best known for their use in reverse resolution through the IN-ADDR.ARPA domain .
15	MX	<i>Mail Exchange</i>	Specifies the location (device name) that is responsible for handling e-mail sent to the domain .
16	TXT	<i>Text String</i>	Allows arbitrary additional text associated with the domain to be stored.

All of these resource records are used in different ways to define zones and devices within them, and then permit name resolution and other functions to take place. We'll see how they are used in more detail in [the section on name resolution](#). You can also find a more lengthy description of some of them in [the topic devoted to resource record field formats](#).



Related Information: See [the topic on IPv6 DNS support](#) for IPv6-specific resource record types.

Resource Record Classes

Finally, a historical note that needs to be mentioned. When DNS was first created, its inventors wanted it to be as generic as possible. To that end, they designed it so that a DNS server could, theoretically, provide name service for more than one type of underlying protocol. That is, DNS could support TCP/IP as well as other protocols simultaneously.

Of course, protocols have different addressing schemes and also varying needs for name resolution. Therefore, DNS was defined so that each protocol could have a distinct set of resource record types. Each set of resource record types was called a *class*. Technically, a resource record must be identified using both a class identifier and a resource record type. Like the resource record types, classes have a numeric code number and a text abbreviation. The class for TCP/IP uses the number 1, with the text code “IN” (for “Internet”).

In practice, this notion of multiple classes of resource records never took off; DNS is today, to my knowledge, only used for TCP/IP. (There may be some obscure exceptions.) Several other classes have been defined by RFC 1035 and are in the IANA DNS parameters list, but they are for relatively obscure, experimental or obsolete network types, with names such as CSNET, CHAOS and Hesiod. You'll still see this concept of “class” in the specification of DNS message and resource record formats, but there really is only class today: “IN” for TCP/IP. For this reason, in most cases, the class name can be omitted in DNS-related commands and data entries, and “IN” will be assumed by default.



Key Concept: The DNS standards were originally created to allow them to work with multiple protocols, by specifying the class of each resource record. Today the only class commonly used is that for TCP/IP, which is called “IN” (for “Internet”).

DNS Name Server Types and Roles: Primary/Master, Secondary/Slave and Caching-Only Servers

In the first two topics in this section, we have looked at the functions of DNS servers, with a particular eye to the important job of storing name server information. There are many thousands of DNS servers on the Internet, and not all are used in the same way. Each DNS server has a particular *role* in the overall operation of the name system. The different kinds of servers also interact with each other in a variety of ways that we need to understand.

Every zone needs to have at least one DNS name server that is responsible for it. These DNS name servers are called *authoritative* servers for the zone, because they contain the full set of resource records that describe the zone. When any device on the Internet wants to know something about a zone, it consults one of its authoritative servers.

From a strictly theoretical perspective, having one name server for each zone or domain is “sufficient” to provide name resolution services for the entire DNS name structure. From an implementation standpoint, however, having only one name server for each part of the name space is not a wise idea. Instead, each zone usually has associated with it at least two name servers: one *primary* or *master* name server, and one *secondary* or *slave* name servers. Some zones may have more than one secondary name server.



Note: The terms “primary” and “secondary” are used often in the DNS standards to refer to the roles of the two authoritative servers for a zone. However, “master” and “slave” are now the preferred terms, because “primary” and “secondary” are somewhat ambiguous and used in other contexts. You should be prepared to see both terms used.

Reasons for Using Slave Name Servers

The master name server is obviously the most essential server. It is on this name server that the [master files](#) for the zone's resource records are maintained, so the master name server is the “final word” for information on the zone. However, there are several reasons why slave servers are also important:

- ☉ **Redundancy:** We've already discussed how important DNS is, especially on the Internet; with only one name server, if it ever failed nobody would be able to resolve names such as “www.xyzindustries.com” into IP addresses, which would be a Bad Thing [tm]. ☺ Slave name servers act as a backup for the masters they support.
- ☉ **Maintenance:** With more than one server, we can easily take the primary server down for maintenance when needed without name resolution service being disrupted.
- ☉ **Load Handling:** Busy zones can use multiple servers to spread the load of name resolution requests to improve performance.
- ☉ **Efficiency:** There are many cases where there is an advantage to positioning a name server in a particular geographical location for the sake of efficiency. For example, a company may have an office in a distant location connected using a low-speed WAN link. To reduce name resolution traffic across that link, it makes sense to have that zone's information available in a name server on both sides of the connection, so one would require two physical servers.

Redundancy is the most important consideration in setting up master and slave name servers. Sticking two machines side by side in a server room, plugged into the same electrical service, both connected to the Internet with the same Internet Service Provider, and making one your master DNS server and the other your slave is not a smart move. Ideally, the primary and secondary servers should be as independent as possible; they should be physically distant and have separate connections to the Internet.

Propagating Information From the Master Server to Slaves

Just as the names “master” and “slave” suggest, the secondary name servers are not the original source of information about a zone. They normally obtain their resource records not from human-edited master files, but from updates obtained from the master server. This is accomplished using a process called a [zone transfer](#). These transfers are performed on a regular basis to ensure that the slave servers are kept up to date. The slaves can then respond to name resolution requests with current information. Both the master and the slave are considered authoritative for the zone.

Name Server Roles

The “master” and “slave” roles for a zone are logical and do not always correspond to individual physical hardware devices. A single physical name server can play multiple roles in the following cases:

- ☉ It can be the master name server for more than one zone. Each zone in this case has a distinct set of resource records maintained in separate master files.
- ☉ It can be a slave name server for more than one zone.
- ☉ It can be a slave name server for certain zones as well as a primary for others.

Note however that a single physical name server cannot be a primary and a secondary server for the **same** zone, since... well, what would be the point?



Key Concept: The *master* DNS server for a zone is its *primary* server, which maintains the master copy of DNS information. Most DNS zones also have at least one *slave* or *secondary* DNS server. These are important because they serve as backups for the primary server, and they can also help share the load of responding to requests in busy zones. Secondary name servers get their information from primary servers on a routine basis. Both master and slave servers are considered authoritative for the zones whose data they maintain.

Caching-Only Name Servers

We'll see later in this section that for efficiency reasons, all DNS servers perform [caching of DNS information](#) so it can be used again if requested in the near future. This includes both master and slave name servers. The importance of caching is so significant that there are some servers that are set up only to cache information from other DNS servers. Unsurprisingly, these are called *caching-only* name servers.

These name servers are not authoritative for any zone or domain, and don't maintain any resource records of their own. They can only answer name resolution requests by contacting other name servers that *are* authoritative and then relaying the information. They then store the information for future requests. Why bother? The reason is performance. Through strategic placement, a caching-only server can increase DNS resolution performance substantially in some networks by cutting down on requests to authoritative servers.



Key Concept: There are DNS servers that do not maintain DNS resource records of their own but solely hold recently-used information from other zones. These are called *caching-only* name servers and are not authoritative for any zone.

DNS Zone Management, Contacts and Zone Transfers

The authority for a particular **DNS zone** is responsible for performing a variety of tasks to manage it. *Zone management* encompasses the entire gamut of jobs related to a zone: deciding on the name hierarchy within the zone, specifying procedures for name registration, technical work related to keeping DNS servers running and other “administrative overhead” of all sorts. This job can be either very small or incredibly large, depending on the type of organization. A small domain owned by an individual doesn’t require much work to manage, while one for a huge company might require a dedicated staff to maintain.

Domain Contacts

It is important that it be possible for anyone on an internetwork to be able to determine who the owner of a domain is, so that person can be reached for whatever reason. On the Internet, each DNS domain has associated with it a set of three *contacts* that are responsible for different facets of managing a domain. These are the:

- ☉ **Administrative Contact:** The “main” contact, responsible for the domain as a whole. This individual or organization is considered the overall owner of the domain.
- ☉ **Billing Contact:** A contact responsible for handling payment for domain services and other accounting matters.
- ☉ **Technical Contact:** A contact who handles the technical details of setting up DNS for the domain and making sure it works.

For smaller domains, there usually is no separate billing contact; it is the same as the administrative contact. In contrast, the technical contact is often different from the administrative contact in both large and small domains. Large organizations will make the technical contact someone in their information technology department. Small organizations often let their Internet Service Provider (ISP) provide DNS services, and in that case, the technical contact would be someone at that ISP.



Key Concept: Each DNS domain has associated with it a set of three contact names that indicate who is responsible for managing it. The administrative contact is the person with overall responsibility for the domain. The billing contact is responsible for payment issues; this may be the same as the administrative contact. The technical contact is in charge of technical matters for the domain, and is often a different person than the administrative contact, especially when DNS services are out-sourced.

Zone Transfers

The ultimate purpose of zone management is to ensure that information about the zone is kept current on the zone's master and slave name servers, so it can be efficiently provided to [name resolvers](#). Thus, the management of a zone begins with decision-making and administrative actions that result in changes to the resource records for the zone. These are reflected in changes made to the DNS master files on the master (primary) DNS server for the zone.

In contrast, each zone's secondary DNS server(s) act as “slaves” to the “master” primary server. They carry information about the zone, but do not load it from local master files that are locally edited. Instead, they obtain their information from the master name server on a regular basis. The procedure responsible for this is called a *zone transfer*.

The resource records on the master name server can be updated at any time; as soon as the master name server's records have been changed, the information at the slave name servers becomes partially out of date. This is not generally a big deal, because most of the data will still be accurate, and the secondary server will continue to respond to resolution requests using the most current information it has. However, it is obviously important that we update the slave servers on a regular basis; if this is not done, eventually their data will become “stale” and unreliable.

Controlling When Zone Transfers Occur Using DNS *Start of Authority* Fields

To this end, it is necessary that zone transfers be performed on a regular basis. This requires implementation of a communication process between the servers that consists of two basic parts. First, we need a mechanism to allow slave servers to regularly check for changes to the data on the master. Second, we must have a mechanism for copying the resource records for the zone from the primary name server to the secondary when needed.

Both mechanisms make use of standard DNS query/response facilities, and special fields in the resource records for the zone. Of particular importance is the *Start Of Authority (SOA)* record for the zone, which contains several parameters that control zone status checking and zone transfers. The formal description of these parameters can be found in [the topic on resource record formats](#), I'll discuss how they are used here.

When a slave name server starts up, it either has no information about the zone at all, or it may have a copy of the zone's resource records stored on its local storage, from the last time it was running. In the former case, it must immediately perform a full zone transfer, since it has no information. In the latter case, it will read its “last known” copy of the zone from local storage; it may immediately perform a *poll* on the master server to see if the data has changed, depending on configuration. A poll is done by requesting the *Start Of Authority* resource record for the zone.

The *Serial* field in the SOA record contains a serial number (which may be arbitrary or may be encoded so it has a particular meaning) that acts as the “version number” of the master server's zone database. Each time the master file for the zone is modified (either manually

by editing or automatically through another means) this serial number is increased. Therefore, a slave server can detect when changes have been made on the master by seeing if the *Serial* field in the most recent SOA record is greater than the one the slave stored the last time it polled the master. If the serial number has changed, the slave begins a zone transfer.

Three other fields in the SOA record control the timing that slave name servers use for polling and updating their information:

- ☉ **Refresh:** This field specifies how many seconds a slave server waits between attempts to check for an update on the master. Assuming the slave can make contact, this is the longest period of time that data on a slave will become “stale” when the master changes.
- ☉ **Retry:** This field controls how long the slave must wait before trying again to check in with the master if its last attempt failed. This is used to prevent “rapid fire” attempts to contact a master that may clog the network.
- ☉ **Expire:** If, for whatever reason, the slave name server is not able to make contact with the master for a number of seconds given by this field value, it must assume that the information it has is stale and stop using it. This means that it will stop acting as an authoritative name server for the zone until it receives an update.

The fact that these parameters are part of the SOA record for the zone gives the administrator of the zone complete control over how often master name servers are updated. In a small zone where changes are rare, the interval between checks made by the slave servers can be increased; for larger zones or ones that are changed often, the *Refresh* interval can be decreased.

Zone Transfer Mechanism

When a zone transfer is required, it is accomplished using a DNS query sent to the master server using the regular DNS query/response messaging method used for name resolution (discussed in the next section). A special DNS question type, called *AXFR* (*address transfer*) is used to initiate the zone transfer. The server will then transfer the resource records for the zone using a series of DNS response messages (assuming that the server that requested the transfer is authorized to do so). Since it's important that zone transfers be received reliably, and since the amount of data to be sent is large and needs to be managed, a TCP session must first be established and used for zone transfers. This is in contrast to the simpler UDP transport used for regular DNS messages. This is discussed in [the topic discussing the use of UDP and TCP for DNS](#).

Once the zone transfer is complete, the slave name server will update its database and return to regular operation. It will continue to perform regular polls of the master server every *Refresh* seconds. If it has a problem with a regular poll, it will try again after *Retry* seconds. Finally, if an amount of time equal to *Expires* seconds elapses, the master name server will stop serving data from the zone until it re-establishes contact with the primary name server.



Key Concept: Slave name servers do not have their DNS information managed directly by an administrator. Instead, they obtain information from their master name server on a periodic basis through a process called a *zone transfer*. Several fields in the *Start Of Authority* DNS resource record control the zone transfer process, including specifying how often transfers are done and how slave name servers handle problem conditions such as an inability to contact the master server.

Note that the DNS *Notify* feature is an enhancement to the basic zone status check / zone transfer model. It allows the master server to notify a slave server when the master's database has changed. Another new feature allows only part of a zone to be transferred instead of the entire zone. [See the topic on DNS name server enhancements for more.](#)

DNS Root Name Servers

The domain name system is strongly oriented around the notion of hierarchical structure: the name space, registration authorities and name servers are all arranged in a tree structure. Like these structures, the name resolution process is also hierarchical. As described in gory detail in [the section on name resolution](#), a [fully-qualified domain name](#) is resolved by starting with the least-specific domain name element (label) and working towards the most-specific one.

Naturally, the least-specific portion of every name is the [root node](#) under which the entire DNS structure exists. This means that, absent caching and other performance enhancements, all name resolution begins with the root of the name tree. We find here a set of name servers that are responsible for name server functions for the DNS root: the *DNS root name servers*.

Like all name servers, they store information about, and provide name resolution services for, all the nodes within the “root zone”. This includes certain specific top-level domains and subdomains. Most top-level domains (TLDs), however, are in their own zones. The root name servers are used as the “go to” spot to obtain the names and addresses of the authoritative servers for each of these TLDs. For example, if we want to resolve the name “www.xyzindustries.co.uk”, the root name servers are where a resolver would find the identity of the name server that is responsible for “uk”.

Ensuring Access to the Root Name Servers

Clearly, the root name servers are extremely important to the functioning of the DNS system as a whole. If anything were to ever happen to cause the root name servers to stop operating, the entire DNS system would essentially shut down. For this reason, there obviously isn't just one root server, nor are there two or three; there are (at present) thirteen different root name servers.

In fact, there are actually far more than thirteen physical servers. Most of the thirteen name servers are implemented as clusters of several independent physical hardware servers. Some are in fact distributed collections of servers that are in different physical locations. The best example is the “F” root server, which has been implemented as a set of over a dozen *mirrors* in various places around the world, to provide better service.

The principles of redundancy that I mentioned are a good idea for choosing a secondary name server for a regular domain, obviously apply that much more to the root. This is why the various physical devices that comprise the thirteen root servers are all located in different places all around the globe. Many of them are in the United States, but even these are in many locations throughout the country (albeit concentrated in a couple of “hot spots” in California and near Washington, DC) and are set up to use different networks to connect to the Internet.

The root name servers are of course rather powerful; despite there being several dozen pieces of hardware to spread the load, they must each handle large amounts of data, 24 hours a day. They are run by networking professionals who ensure that they function efficiently. An Internet standard, RFC 2870 (*Root Name Server Operational Requirements*), spells out the basic rules and practices for the operation of these name servers. It specifies extensive procedures for ensuring the security of the servers, and for avoiding performance problems due to their pivotal role.

Despite all the efforts taken to ensure that the root servers are widely distributed and secure, they still collectively represent a point of weakness in the global Internet. Millions and millions of people depend on these servers. There have been incidents in the past where rogue elements on the Internet have attempted to disrupt DNS by attacking the root name servers. One widely-publicized incident was a denial of service (DoS) attack against the root servers on October 21, 2002. The attack failed, but it significantly raised awareness of the importance of these servers and how essential DNS security is.



Key Concept: Information about the DNS root and its top-level domains is managed by a set of *root name servers*. These servers are essential to the operation of DNS; they are arranged into thirteen groups and physically distributed around the world.

Current Root Name Servers

Originally, the root name servers were given domain names reflecting the organizations that ran them. In these historical names we can see a veritable “who's who” of the big players in the development of the Internet: ISI, NASA, the United States military and others. Several of the servers are still run by government agencies or the US military, where added security can be put into place to protect them. For convenience, however, all the root name servers are now given alphabetical “letter names” in the special domain “root-servers.net”.

Table 168 shows the most current information about the DNS root name servers as of the date of publishing of this Guide. For your interest and amusement I have also mapped the locations of these servers in Figure 242.

Table 168: Internet DNS Root Name Servers

Root Server Name	IP Address	Historical Name	Location(s)
a.root-servers.net	198.41.0.4	ns.internic.net	Dulles, VA, USA
b.root-servers.net	128.9.0.107	ns1.isi.edu	Marina Del Rey, CA, USA
c.root-servers.net	192.33.4.12	c.psi.net	Herndon, VA and Los Angeles, CA, USA
d.root-servers.net	128.8.10.90	terp.umd.edu	College Park, MD, USA
e.root-servers.net	192.203.230.10	ns.nasa.gov	Mountain View, CA, USA
f.root-servers.net	192.5.5.241	ns.isc.org	Auckland, New Zealand; Sao Paulo, Brazil; Hong Kong, China; Johannesburg, South Africa; Los Angeles, CA, USA; New York, NY, USA; Madrid, Spain; Palo Alto, CA, USA; Rome, Italy; Seoul, Korea; San Francisco, CA, USA; San Jose, CA, USA; Ottawa, ON, Canada
g.root-servers.net	192.112.36.4	ns.nic.ddn.mil	Vienna, VA, USA
h.root-servers.net	128.63.2.53	aos.arl.army.mil	Aberdeen, MD, USA
i.root-servers.net	192.36.148.17	nic.nordu.net	Stockholm, Sweden; Helsinki, Finland
j.root-servers.net	192.58.128.30	—	Dulles, VA, USA; Mountain View, CA, USA; Sterling, VA, USA; Seattle, WA, USA; Atlanta, GA, USA; Los Angeles, CA, USA; Amsterdam, The Netherlands
k.root-servers.net	193.0.14.129	—	London, UK; Amsterdam, The Netherlands
l.root-servers.net	198.32.64.12	—	Los Angeles, CA, USA
m.root-servers.net	202.12.27.33	—	Tokyo, Japan



On The Web: The current list of root name servers can be found in the file <ftp://ftp.rs.internic.net/domain/named.root>. You can also find the information in a more user-friendly format at <http://www.root-servers.org>.

DNS Name Server Caching, Negative Caching and Data Persistence

Most of the “grunt work” done by name servers is responding to [name resolution requests](#). Busy servers, like the root name servers, the ones that carry zone information for the top-level domains, and ones that serve very busy zones, have to handle hundreds or even

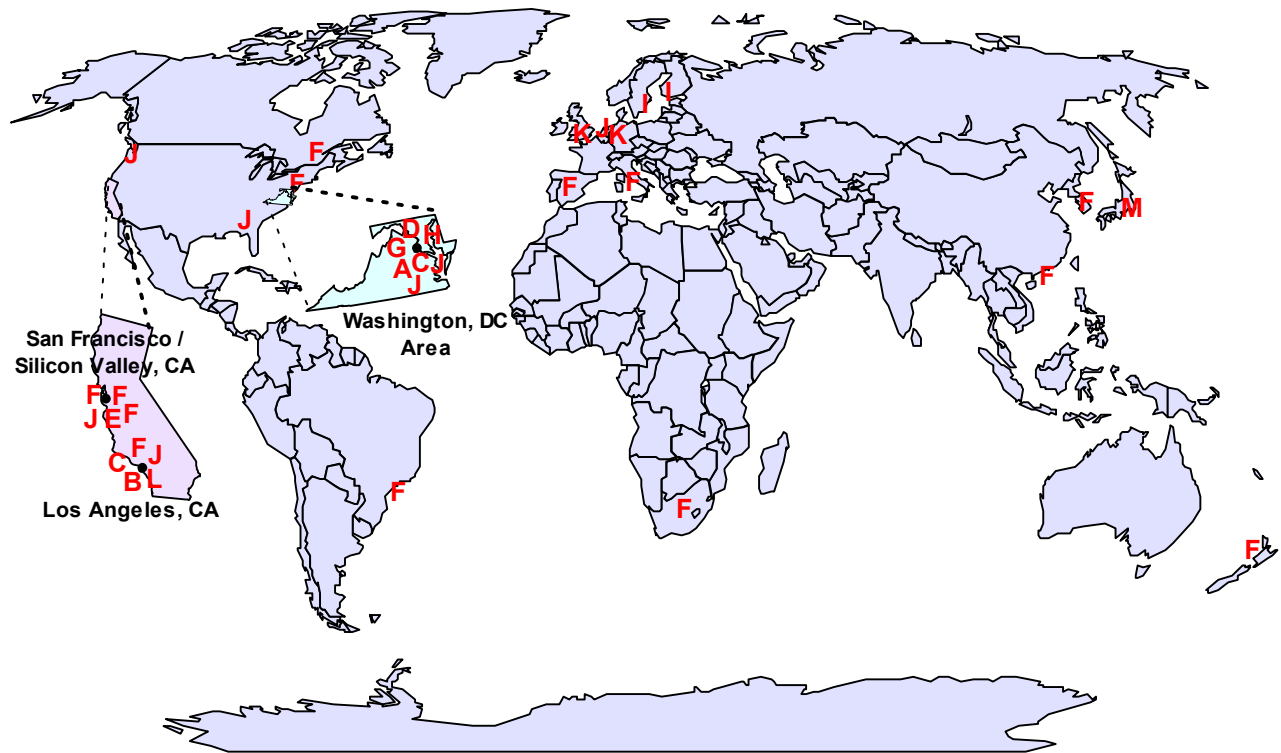

Figure 242: Geographic Locations of Internet DNS Root Name Servers

thousands of name resolution requests each *second*. Each of these requests takes time and resources to resolve; it also takes internetwork bandwidth away from the business of transferring data. It is essential, therefore, that DNS server implementations employ mechanisms to improve their efficiency and cut down on unnecessary name resolution requests. One of the most important of these is *caching*.

Name Server Caching

The word *cache* refers to a store, or a place where something is kept. In the computer world, the term usually refers to an area of memory set aside for storing information that has been recently obtained so it can be used again. In the case of DNS, caching is used by DNS name servers to store the results of recent name resolution and other requests, so that if the request occurs again it can be satisfied from the cache without requiring another complete run of the name resolution process. Due to how most people use computers, a particular request is often followed by another request for the same name, so caching can significantly reduce the number of requests that result in complete name resolution procedures.

An example is the best way to illustrate this. Suppose you are using a host on your company's local network. This host is probably configured to use your company's DNS name server to handle resolution requests. You type "www.xyzindustries.com" into your Web browser, which causes a resolution attempt to be made for that address. Most likely,

your local DNS server doesn't know that name, so it will follow the complete **name resolution process** to get its address. After doing this, your local DNS server will *cache* the name "www.xyzindustries.com" and the address associated with it.

If you click on a link for a page at that Web site, that new page will also probably be somewhere at the "www.xyzindustries.com" site. This will result in another DNS resolution request being sent off to your local DNS server again. However, this time, the local server will not have to perform a resolution; it remembers that this name is in its cache and returns the saved address for the name immediately. Voila! You get your answer faster, and unnecessary Internet traffic is avoided.



Key Concept: *Caching* is an essential efficiency feature that reduces DNS message traffic by eliminating unnecessary requests for recently-resolved names. Whenever a name is resolved the resulting DNS information is cached so it can be used for subsequent requests that occur shortly thereafter.

Caching Data Persistence and the Time To Live Interval

Of course, things aren't entirely this simple. One very important issue that comes up with every caching system, including the one used in DNS, is the matter of the *freshness* of the cache. Suppose our local DNS server resolves the name "www.xyzindustries.com" and then caches its address. In the example above where we click a link a few seconds after the XYZ Industries home page loads, we aren't likely too concerned about how fresh the DNS data is. But how about if we shut down our computer to go on vacation for 2 weeks and then come back to work and type the name again into our browser. If our local server still has the name in its cache, how do we know the IP address of "www.xyzindustries.com" hasn't changed during that two-week period?

Two different mechanisms are used to address this issue. The first is that when data is cached, the caching server also makes a note of the authoritative server from which it came. When a resolver (client) asks for a name resolution and the address is drawn from the cache, the server marks the answer as *non-authoritative* to clearly tell the client that the name came from the cache. The server also supplies the name of the authoritative server that originally supplied the data.

The client then has a choice: it can either use the non-authoritative answer, or issue a request for a fresh name resolution from the authoritative server. This is a trade-off between performance (using the cached data) and currency (asking for a fresh resolution each time). Usually, the cached data can be used safely, because DNS information doesn't change very often.

The second technique for ensuring that caching data doesn't get too old is a procedure for limiting the *persistence* of DNS cached data. Each resource record has associated with it a time interval, called the *Time To Live (TTL)*. Whenever a resource record is read from a server, the *TTL* for the record is also read. Any server caching the record is supposed to discard the record after that time interval expires.

Each zone also has associated with it a default value for the *TTL* field to be applied to all records in the zone. This allows an administrator to select a *TTL* value for all records in a zone without having to enter *TTL* numbers for each record individually. At the same time, the administrator can assign an “override” *TTL* value to any records that need a number different from the default. This default *TTL* was originally found in the special *Start Of Authority* resource record for each zone, but is now done using a special directive in the zone’s [master file](#).



Note: This *Time To Live* field is not related to [the one used in Internet Protocol datagrams](#). Obviously IP and DNS are totally different protocols; more than that, despite having the same name, the *TTL* fields in IP and DNS don't have the same meaning at all.

It's worth emphasizing that DNS gives control over caching to the **owner of the record**, not whoever is running the DNS server doing the caching. While it is possible for a particular caching server to “override” the *TTL* and specify how long data will be held in its own cache, DNS is not supposed to work that way. The ability to specify a *TTL* on a record-by-record basis allows the persistence of cache data to be tailored to the needs of the individual data elements. Data that changes often can be given a small *TTL* value, while infrequently-modified records can be given a higher *TTL*. Selecting the *TTL* value must be done carefully; this is another trade-off between performance (which is optimized with higher *TTL* values, reducing the number of queries made for cached data) and “freshness” of the data (which increases as *TTL* is lowered).



Key Concept: Cached information can become stale over time, and result in incorrect responses sent to queries. Each resource record can have associated with it a time interval, called the *Time To Live (TTL)*, that specifies how long the record may be held in a cache. The value of this field is controlled by the owner of the resource record, who can tailor it to the specific needs of each resource record type.

Negative Caching

Classical DNS caching stores only the results of successful name resolutions. It is also possible for DNS servers to cache the results of **unsuccessful** name resolution attempts; this is called *negative caching*. To extend the example above, suppose you mistakenly thought the name of the company's web site was “www.xyz-industries.com” and typed that into your browser. Your local DNS server would be unable to resolve the name, and would mark that name as “unresolvable” in its cache; a negative cache entry.

Suppose you typed the name in incorrectly because someone mis-typed it on an internal memo. If a colleague later tried the same name, the DNS server would say “I already know this is a bogus name” and not try again to resolve it. Since there is no resource record for an invalid name the server itself must decide how long to cache this negative information.

Negative caching improves performance because resolving a name that doesn't exist takes resources, just as resolving an existent one does. Note that “regular” caching is sometimes called “positive caching” to contrast it to “negative caching”.

The value to be used for negative caching in a zone is now specified by the *Minimum* field in the *Start Of Authority* resource record for each zone. As mentioned above, this was formerly used to specify the default *TTL* for a zone.

DNS Name Server Load Balancing

The *Address (A)* resource record is the most fundamental one in DNS, since it records an actual mapping between a domain name and an IP address. Let's consider for a moment one of the words in that sentence in more detail. No, not “address” or “resource record” or “mapping”. The word “an”. ☺ The *Address* record only mentions a **single** address for each domain name. This means that, as we have described DNS so far, each domain name maps to only a single physical hardware device.

When the number of requests that a particular server or other device needs to handle is relatively small, this is not a problem—the function can usually be implemented using a single physical hardware device. If the server gets busier, the usual solution is to throw more hardware at the problem—get a bigger machine. However, some hosts on a large internetwork, especially the Internet, feature servers that must handle tremendous amounts of traffic from many clients. There simply is no single hardware device that can readily handle the traffic of a site like “www.cnn.com” or “www.microsoft.com” for example, without becoming unwieldy.

Using Multiple Address Records to Spread Out Requests to a Domain

Sites like CNN's must use a technique called *load balancing* to spread requests across multiple hardware servers. One simple way to do this would be to have multiple machine names; for example, CNN could create several different Web sites called “www1.cnn.com”, “www2.cnn.com” and so on, each of which points to a different hardware device. DNS certainly supports this type of solution. The problem with this solution is that it is cumbersome; it requires users to remember multiple server names.

It would be better if we could balance the load automatically. DNS supports this by providing a simple way to implement load balancing. Instead of specifying a single *Address* resource record for a name, we can create several such records, thereby associating more than one IP address with a particular DNS name. When we do this, each time the authoritative name server for the zone in which that name exists resolves that name, it sends all the addresses on the list back to the requester. The server changes the order of the addresses supplied in the response, choosing the order randomly or in a sequential “round robin” fashion. The client will usually use the first address in the list returned by the server, so by changing the list, the server ensures that requests for that device's name are resolved to multiple hardware units.

As Internet traffic increases, load balancing is becoming more popular. In early 2003 I saw a survey that indicated approximately 10% of Internet names at that time used load balancing—a fairly significant number. Most employed either two or three addresses, but some used as many as 60! Incidentally, at last check, “www.cnn.com” was associated with eight different IP addresses. (Incidentally, you can check the number of addresses associated with a name using the [“host” command](#).)



Key Concept: Rather than creating a single *Address* resource record for a DNS domain name, it is possible to create multiple. This associates several IP addresses with one name, which can be used to spread a large number of access to one domain name over many physical IP devices. This allows DNS to implement load balancing for busy Internet servers.

Using Multiple DNS Servers to Spread Out DNS Requests

“DNS load balancing” also has a completely different meaning from what I described above. In my discussion of DNS server roles, I talked about how each zone should have at least one secondary DNS server in addition to the primary. The usually-stated main reason for this is redundancy, in case something happens to cause the master server to fail. However, having a slave server can also allow the load of DNS resolution requests to be balanced between multiple servers. In fact, some busy domains have more than two servers specifically for this reason.

Thus, “DNS load balancing” can refer to either using DNS to spread the load of requests (such as Web page requests) to a device that is named using DNS, or to spreading the load of DNS requests themselves.

DNS Name Server Enhancements: DNS Notify, Incremental Zone Transfers, and DNS Update (Dynamic DNS)

The fundamentals of operation of Domain Name System servers, as explained in the preceding topics in this section, are specified in the main DNS standards, RFC 1034 and 1035. These documents are pretty old by computer industry standards; they were published in 1987. To the credit of the designers of DNS, most of what they originally put into the DNS protocol is still valid and in use today. The creators of DNS knew that it had to be able to “scale” to a large size, and the system has in fact successfully handled the expansion of the Internet to a degree far beyond what anyone could have imagined 15 or so years ago.

As originally defined, the Domain Name System requires that DNS information be updated manually by editing master files on the primary server for a zone. The zone is then copied in its entirety to slave servers using a [polling/zone-transfer mechanism](#). This method is satisfactory when the internetwork is relatively small, and changes to a zone are made infrequently.

However, in the modern Internet, large zones may require nearly-constant changes to their resource records. Hand-editing and constantly copying master files can be impractical, especially when they grow large, and having slave servers get out of date between zone transfers may lead to reliability and performance concerns. For these reasons, several enhancements to the operation of DNS servers have been proposed over the years. I'm going to take a closer look at three of them here.

Automating Zone Transfers: DNS Notify

The first problem that many DNS administrators wanted to tackle was the reliance on polling for updating slave name servers. Imagine that you placed an order for a new music CD at your favorite online music store, but it was out of stock—backordered. Which makes more sense: having you call them every 6 hours to ask if it has arrived yet until it gets there, or having the store simply call you when it shows up?

The answer is so obvious that the question seems ridiculous. Yet DNS uses the first model: slave name servers must constantly “call up” their zone masters and ask them “has anything changed yet?” This both generates unnecessary traffic, and results in the slave name server being out of date from the time the master **does** change until the next poll is performed. Tweaking the *Refresh* time for the zone only allows one to choose between more polls or more staleness when changes happen; neither is really “good”.

To improve upon this situation, a new technique was developed; it was formalized in RFC 1996, published in 1996 (weird coincidence!) This standard, [A Mechanism for Prompt Notification of Zone Changes \(DNS NOTIFY\)](#), defines a new DNS message type called *Notify*, and describes a protocol for its use. The *Notify* message is a variation on the [standard DNS message type](#), with some of the fields redefined to support this new feature.

When both the master and slave name servers support this feature, when a modification is made to a resource record, the master server will automatically send a *Notify* message to its slave server(s), saying “your CD has arrived!” er... “the database has changed”. ☺ The slave then acts as if its *Refresh* timer has just expired. Enabling this feature allows the *Refresh* interval to be dramatically increased, since slave servers don't need to constantly poll the master for changes.



Key Concept: The optional DNS *Notify* feature allows a master name server to inform slave name servers when changes are made to a zone. This has two advantages: it cuts down on unnecessary polling by the slave servers to find out if changes have occurred to DNS information, and it also reduces the amount of time that slave name servers have out-of-date records.

Improving Zone Transfer Efficiency: Incremental Transfers

The second issue with regular DNS is the need to transfer the entire zone whenever a change to any part of it is made. There are many zones on the Internet that have truly enormous master files that change constantly. Consider the master files for the “.COM” zone for example; having to copy the entire thing to slave name servers every time there is a change to even one record is beyond “inefficient”—it's downright insane!

RFC 1995, *Incremental Zone Transfer in DNS*, specifies a new type of zone transfer called an *incremental zone transfer*. When this feature is implemented on master and slave name servers in a zone, the master server keeps track of the most recent changes made to the database. Each time a slave server determines that a change has occurred and the secondary's database needs to be updated, it sends an *IXFR (incremental transfer)* query to the master, which contains the *Serial* number of the slave's current copy of the database. The master then looks to see what resource records have changed since that *Serial* number was the current one, and sends only the updated resource records to the secondary server.

To conserve storage, the master server obviously doesn't keep all the changes made to its database forever. It will generally track the last few modifications to the database, with the *Serial* number associated with each. If the slave sends an *IXFR* request that contains a *Serial* number for which recent change information is still on the primary server, only the changes are sent in reply. If the request has a *Serial* number so old that the master server no longer has information about some of the changes since that version of the database, a complete zone transfer is performed instead of an incremental one.



Key Concept: The DNS *incremental zone transfer* enhancement uses a special message type that allows a slave name server to determine what changes have occurred since it last synchronized with the master server. By transferring only the changes, the amount of time and bandwidth used for zone transfers can be significantly reduced.

Dealing With Dynamic IP Addresses: DNS Update / Dynamic DNS

The third problem with “classical” DNS is that it assumes changes are made infrequently to zones, so they can be handled by hand-editing master files. Some zones are so large that hand-editing of the master files would be nearly continuous. However, the problem goes beyond just inconvenience. Regular DNS assumes that the IP address for a host is relatively static. Modern networks, however, make use of host technologies such as the [Dynamic Host Configuration Protocol \(DHCP\)](#) to assign IP addresses dynamically to devices. When DHCP is used, the IP address of *each* host in a zone could change on a weekly, daily or even hourly basis! Clearly, there would be no hope of keeping up with this rate of change using a human being and a text editor.

In April 1997, RFC 2136 was published, entitled *Dynamic Updates in the Domain Name System (DNS UPDATE)*. This standard describes an enhancement to basic DNS operation that allows DNS information to be dynamically updated. When this feature is implemented, the resulting system is sometimes called *Dynamic DNS (DDNS)*.

RFC 2136 defines a new DNS message type: the *Update* message. Like the *Notify* message, the *Update* message is designed around the structure of regular DNS messages, but with changes to the meanings of several of the fields. As its name implies, *Update* messages allow resource records to be selectively changed within the master name server for a zone. Using a special message syntax, it is possible to add, delete or modify resource records.

Obviously, care must be taken in how this feature is used; we don't want just anyone to be making changes “willy-nilly” to our master records. The standard specifies a detailed process for verifying *Update* messages, and security procedures that must be put into place so the server only accepts such messages from certain individuals or systems.

Dynamic DNS allows changes to be made much more easily for an administrator, but its true power only becomes evident when it is used to integrate DNS with other address-related protocols and services. Dynamic DNS solves a major weakness with traditional DNS: the inability to easily associated a host name with an address assigned using a protocol like DHCP.

With DNS servers supporting this feature, DNS and DHCP can be integrated, allowing automatic address and name assignment, and automatic update of DNS records when a host's IP address changes. One common application of dynamic DNS is to allow the use of DNS names by those who access the Internet using a service provider that dynamically assigns IP addresses. Dynamic DNS is similarly used by certain directory services, notably Microsoft's Active Directory, to associate addresses with device names.



Key Concept: An enhancement to DNS, commonly called *dynamic DNS*, allows DNS information in a server's database to be updated automatically, rather than always requiring hand-editing of master files. This can not only save time and energy on the part of administrators, it allows DNS to better handle dynamic address assignment, such as the type performed by host configuration protocols such as DHCP.



DNS Resolution Concepts and Resolver Operations

In the preceding three sections, I have described the Domain Name System's [name space](#), [authority and registration mechanism](#), and [name servers](#). These elements can all be considered part of the *infrastructure* of DNS; they are the parts of the system that must be established first to enable it to be used. Once we have these components in place, we can actually get down to the business at hand: name resolution. This is accomplished using a specific set of procedures carried out by DNS clients called *resolvers*.

In this section I describe DNS name resolvers and the process of name resolution itself. I begin with an overview of the functions performed by DNS resolvers and how they work in general terms. I then describe the two fundamental methods of name resolution used in DNS: iterative and recursive resolution. I discuss the way that resolvers improve efficiency through local resolution and caching. I describe the steps in the actual name resolution algorithm. I then cover two special cases of name resolution: reverse name resolution using the special IN-ADDR.ARPA domain, and the way that DNS provides mail support using *Mail Exchange* resource records.



Related Information: The information in this section complements that in [the previous section on DNS name servers](#). I assume in the topics here that you have at least basic familiarity with DNS servers.

DNS Resolver Functions and General Operation

The DNS name servers we explored in [the preceding section](#) are arguably the most important part of the system as a whole. After all, they store all the data on the system and actually provide the addresses we need when names are given to them; without these servers, there would be no DNS at all. Of course, what use is a server if nobody is asking for service? The clients in the system, called *resolvers*, are also important, because they initiate the process of name resolution; resolvers are where the “rubber meets the road”, so to speak.

The operation of DNS resolvers is explained in the two main DNS standards. RFC 1034 describes the functions performed by resolvers, and how they work in general terms. This includes a discussion of the algorithm used to conduct name resolution. RFC 1035 deals more with the implementation details of resolvers, and the fine points of **how** they do their jobs. Several subsequent standards have of course modified these base standards, changing some of the ways that resolvers work in different ways.

Name Resolution Services

Just as the main job of a DNS server is to store DNS name data and “serve” it when it receives requests, the main job of a DNS resolver is to, well, **resolve**. ☺ While most people only think of name resolution as the process of transforming a DNS name into an IP address, this is but one of several types of resolution services performed by DNS. A few of the most typical types of DNS resolution are:

- ☉ **Standard Name Resolution:** Taking a DNS name as input and determining its corresponding IP address.
- ☉ **Reverse Name Resolution:** Taking an IP address and determining what name is associated with it.
- ☉ **Electronic Mail Resolution:** Determining where to send electronic mail (e-mail) messages based on the e-mail address used in a message.

There are other types of resolution activities as well, though again, most name resolution requests are of the “standard” variety, making it the primary focus in our discussion.

Resolution Functions Performed By Name Resolvers

To accomplish its resolution duties, name resolvers perform a number of related functions:

- ☉ **Providing The User Interface:** In order for DNS to be of maximum value to TCP/IP users, it must be possible for names to be used interchangeably with addresses. This is usually done automatically by the resolver, which provides an interface to the user to allow names to be entered and used like addresses.
- ☉ **Forming and Sending Queries:** Given a name to resolve, the DNS resolver must create an appropriate query using the DNS messaging system, determine what type of resolution to perform, and send the query to the appropriate name server.
- ☉ **Processing Responses:** The resolver must accept back responses from the DNS server to which it sent its query, and decide what to do with the information within the reply. As we'll see, it may be necessary for more than one server to be contacted for a particular name resolution.

This seems fairly simple, and it is in some ways, but implementation can become rather complicated. Bear in mind that the resolver may need to “juggle” several outstanding name resolutions simultaneously. It has to keep track of the different requests, queries and responses and make sure everything is kept straight.

The user interface is a very important part of a name resolver’s job. We want users to be able to just use a name and have their software automatically treat it like an address. For this reason, normal name resolution usually doesn't involve explicitly running a piece of “resolver software”. Consider again your Web browser. You don't have to say “please find the IP address for `www.xyzindustries.com`” and then say “please connect to this IP address for XYZ Industries”. You just type in “`www.xyzindustries.com`” and the name resolution happens “magically”.

There is no magic, of course. The resolver is just called *implicitly* instead of explicitly. The Web browser recognizes that a name has been entered instead of an IP address and feeds it to the resolver, saying “I need you to resolve this name, please”. (Hey, it never hurts to be polite.) The resolver then takes care of resolution and provides the IP address back to the Web browser, which connects to the site. Thus, the resolver is the interface between the user (both the human user and the software user, the browser) and the DNS system.



Key Concept: The primary clients in DNS are software modules called DNS *name resolvers*. They are responsible for accepting names from client software, generating resolution requests to DNS servers, and processing and returning responses.

Other Functions Performed By Name Resolvers

Name resolvers don't have to perform nearly as many administrative jobs as name servers do; clients are usually simpler than servers in this regard. One important support function that many name resolvers **do** perform, however, is **caching**. Like name servers, name resolvers can cache the results of the name resolutions they perform to save time if the same resolution is required again (not all resolvers perform caching, however.)

I should point out that even though resolvers are the DNS components that are most associated with name resolution, name servers can also act as clients in certain types of name resolution. In fact, it is possible to set up a network so that the resolvers on each of the client machines do nothing more than hand resolution requests to a local DNS server and let the server take care of it. In this case, the client resolver becomes little more than a shell, sometimes called a *stub resolver*. This has the advantage of centralizing name resolution for the network, but a potential disadvantage of performance reduction.

DNS Basic Name Resolution Techniques: Iterative and Recursive Resolution

Conventional name resolution transforms a DNS name into an IP address. At the highest level, this process can be considered to have two phases. In the first phase, we locate a DNS name server that has the information we need: the address that goes with a particular name. In the second phase, we send that server a request containing the name we want to resolve, and it sends back the address required.

The Difficult Part of Name Resolution: Finding The Correct Server

Somewhat ironically, the second phase (the actual mapping of the name into an address) is fairly simple. It is the first phase—finding the right server—that is potentially difficult, and comprises most of the work in DNS name resolution. While perhaps surprising, this is a predictable result of how DNS is structured. Name information in DNS is not centralized, but rather distributed throughout a **hierarchy of servers**, each of which is responsible for one zone in the DNS name space. This means we have to follow a special sequence of steps to let us find the server that has the information we need.

The formal process of name resolution parallels the tree-like hierarchy of the DNS name space, authorities and servers. Resolution of a particular DNS name starts with the most general part of the name, and proceeds from it to the most specific part. Naturally, the most general part of every name is the *root* of the DNS tree, represented in a name as a trailing “dot”, sometimes omitted. The next most-specific part is the top-level domain, then the second-level domain and so forth. The DNS name servers are “linked” in that the DNS server at one level knows the name of the servers that are responsible for subdomains in zones below it at the next level.

Suppose we start with the fully-qualified domain name (FQDN) “C.B.A.”. Formally, every name resolution begins with the root of the tree—this is why the root name servers are so important. It’s possible that the root name servers are authoritative for this name, but probably not; that’s not what the root name servers are usually used for. What the root name server **does** know is the name of the server responsible for the top-level domain, “A.”.

The name server for “A.” in turn may have the information to resolve “C.B.A.” It’s still fairly high-level, though, so “C.B.A” is probably not directly within its zone. In that case, it will not know the address we seek, but it will know the name of the server responsible for “B.A.”. In turn, that name server may be authoritative for “C.B.A.”, or it may just know the address of the server for “C.B.A.”, which will have the information we need. As you can see, it is very possible that several different servers may be needed in a name resolution.



Key Concept: Since DNS name information is stored as a distributed database spread across many servers, name resolution cannot usually be performed using a single request/response communication. It is first necessary to find the correct server that has the information that the resolver requires. This usually requires a sequence of message exchanges, starting from a root name server and proceeding down to the specific server containing the resource records that the client requires.

DNS Name Resolution Techniques

The DNS standards actually define two distinct ways of following this hierarchy of servers to discover the correct one. They both eventually lead to the right device, but they differ in how they assign responsibility for resolution when it requires multiple steps.

Iterative Resolution

When a client sends an iterative request to a name server, the server responds back with either the answer to the request (for a regular resolution, the IP address we want) **or** the name of another server that has the information or is closer to it. The original client must then *iterate* by sending a new request to this referred server, which again may either answer it or provide another server name. The process continues until the right server is found; the method is illustrated in [Figure 243](#).

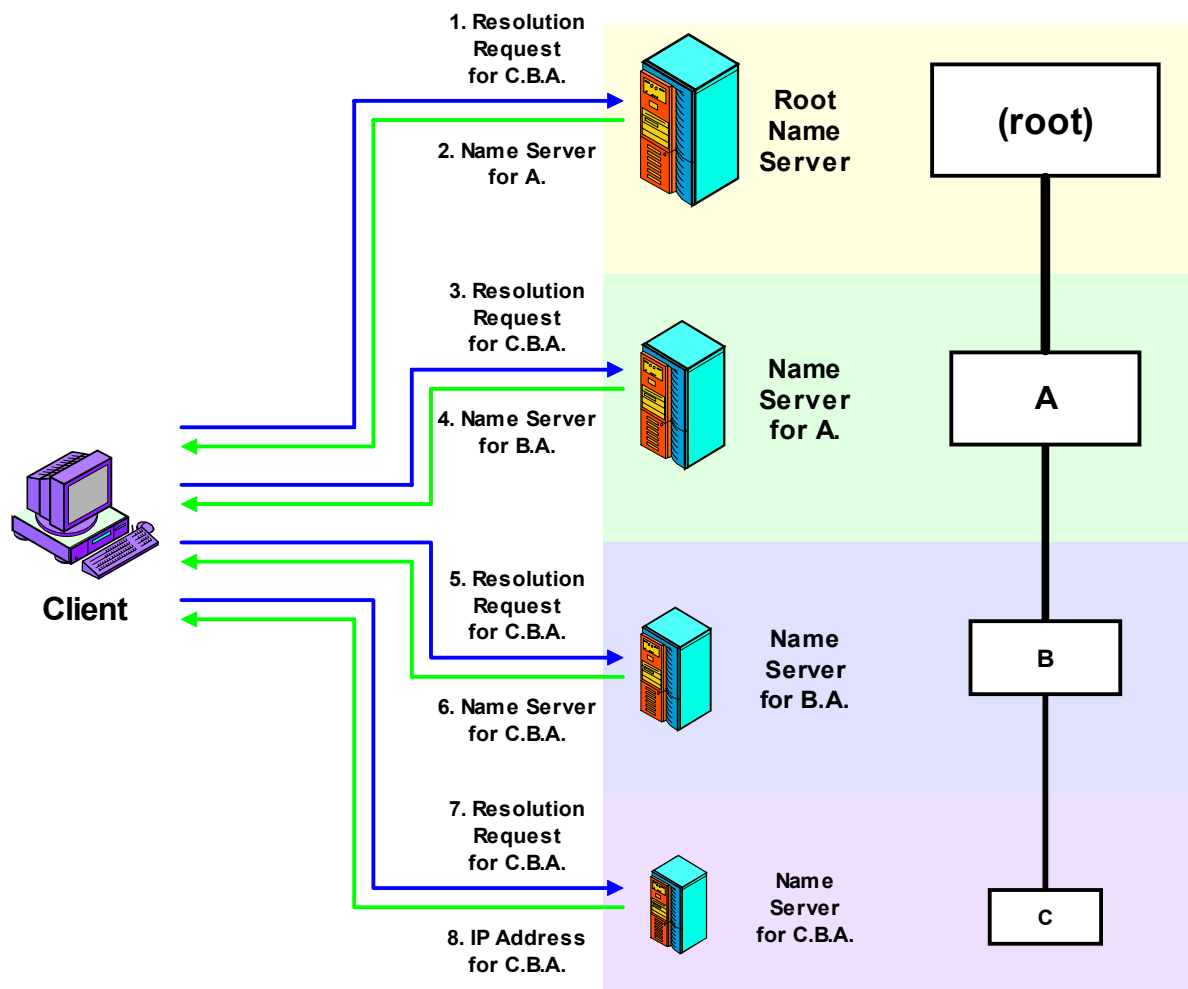

Figure 243: Iterative DNS Name Resolution

In this example, the client is performing a name resolution for "C.B.A." using strictly iterative resolution. It is thus responsible for forming all DNS requests and processing all replies. It starts by sending a request to the root name server for this mythical hierarchy. That server doesn't have the address of "C.B.A.", so it instead returns the address of the name server for "A.". The client then sends its query to that name server, which points the client to the server for "B.A.". That name server refers the client to the name server that actually has the address for "C.B.A.", which returns it to the client. Contrast to [Figure 244](#).

Recursive Resolution

When a client sends a recursive request to a name server, the server responds back with the answer if it has the information sought. If it doesn't, the server takes responsibility for finding the answer by becoming a client on behalf of the original client and sending new requests to other servers. The original client only sends one request, and eventually gets the information it wants (or an error message if it is not available). This technique is shown in [Figure 244](#).

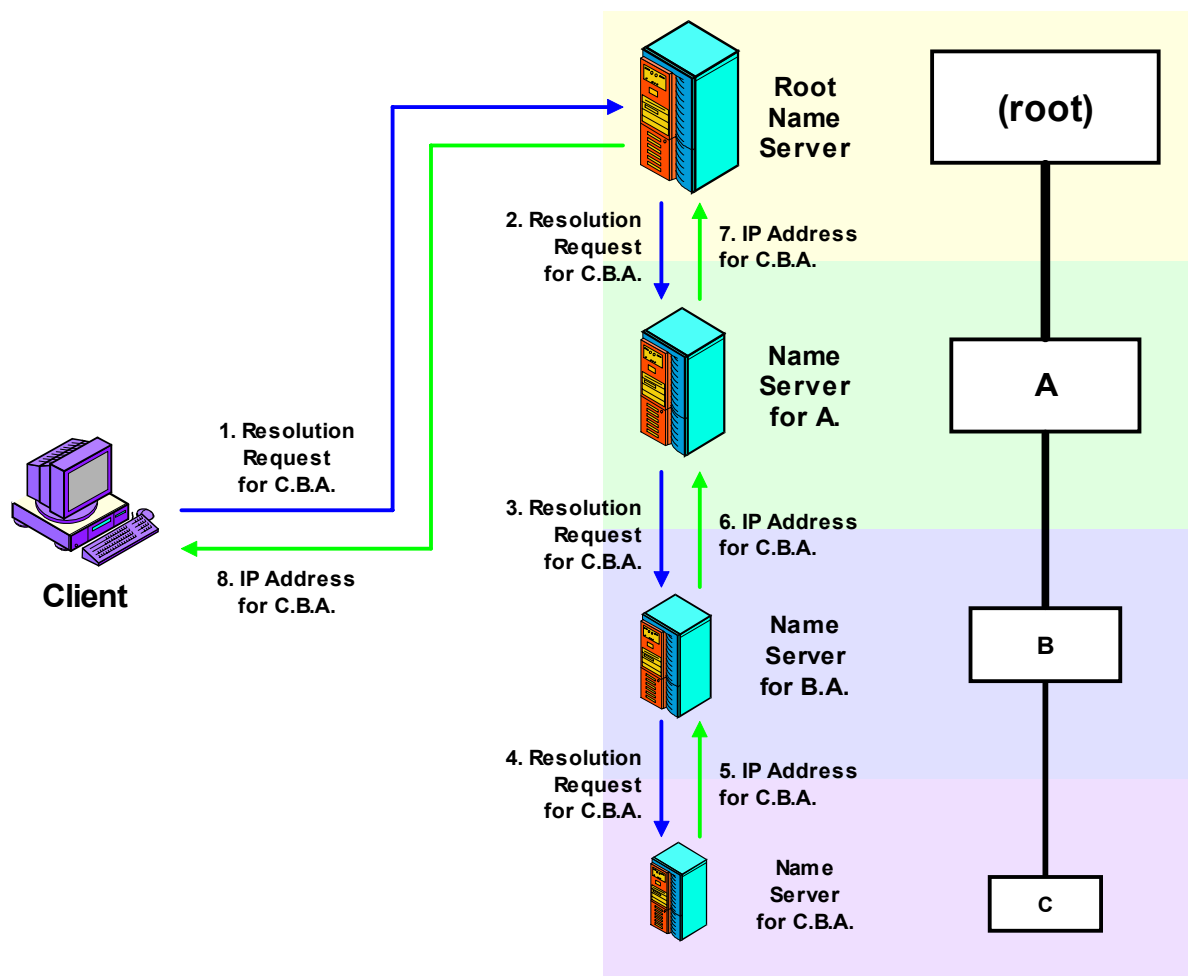

Figure 244: Recursive DNS Name Resolution

This is the same theoretical DNS resolution that I showed in [Figure 243](#), but this time, the client asks for the name servers to perform recursive resolution and they agree to do so. As in the iterative case, the client sends its initial request to the root name server. That server doesn't have the address of "C.B.A.", but instead of merely returning to the client the address of the name server for "A.", it sends a request to that server itself.

That name server sends a request to the server for "B.A.", which in turn sends a request to the server for "C.B.A.". The address of "C.B.A." is then carried back up the chain of requests, from the server of "C.B.A." to that of "B.A.", then "A.", then the root, and then finally, back to the client.

Contrasting Iterative and Recursive Resolution

To help explain the difference between these methods, let's take a side-trip to a real-world case. Suppose you are trying to find the phone number of your old friend Carol, with whom you haven't spoken in years. You call your friend Joe; he doesn't have Carol's number, but he gives you John's number, suggesting you call him. So you dial up John; he doesn't have the information but he knows the number of Carol's best friend, Debbie, and gives that to you. You call Debbie and she gives you Carol's information. This is an example of an iterative process. In contrast, suppose you called Joe and Joe said "I don't know, but I think I know how to find out ". He called John and then Debbie and called you back with the phone number. That would be like recursive resolution.

So in essence, iteration is doing the job yourself, while recursion is “passing the buck”. You might think that everyone would always want to use recursion since it makes “the other guy” do the work. This is true, but “passing the buck” is not considered good form if it is not done with permission. Not all name servers support recursion, especially servers near the top of the hierarchy. Obviously, we don’t want to bog down the root name servers and the ones that handle “.COM” and other critical TLDs with doing recursion. It is for this reason that clients must *request* that name servers perform recursion for them.

One place where recursion *is* often used is with the local name server on a network. Rather than making client machine resolvers perform iterative resolution, it is common for the resolver to generate a recursive request to the local DNS server, which then generates iterative requests to other servers as needed. As you can see, recursive and iterative requests can be combined in a single resolution, providing significant flexibility to the process as a whole. This is demonstrated in a more realistic example in [the topic detailing the DNS name resolution process](#).

Again, remember that for the purpose of understanding resolution, a DNS server can in fact act as a client. As soon as a DNS server accepts a recursive request for resolution on a name it cannot resolve itself, it becomes a client in the process. I should also point out that it is common for resolvers to know the names of not one but two local DNS servers, so if a problem occurs reaching the first they can try the second.



Key Concept: The two methods of name resolution in DNS are *iterative resolution* and *recursive resolution*. In iterative resolution, if a client sends a request to a name server that does not have the information the client needs, the server returns a pointer to a different name server and the client sends a new request to that server. In recursive resolution, if a client sends a request to a server that doesn’t have the requested information, that server takes on the responsibility for sending requests to other servers to find the necessary records, then returns them to the client. A server doing this takes on the role of client for its requests to other servers.

DNS Name Resolution Efficiency Improvements: Caching and Local Resolution

The basic resolution techniques—[iterative and recursive](#)—can be considered “complete” from an algorithmic standpoint. By starting at the top (root) and working our way down, we are “guaranteed” to always eventually arrive at the server that has the information we need. I put “guaranteed” in quotes only because as always, there are no real “guarantees” in networking—we might have asked for a non-existent name, or a server might have bad data for example. But in the absence of such atypical problems, the process leads to the information eventually.

The problem is that last word: “eventually”. Both iterative and recursive resolution will get us to the right server, but they take a long time to do it, especially if the name we are trying to resolve is in a “deep” part of the DNS hierarchy (for example, “F.E.D.C.B.A.”). Since resolution is done so often, it is helpful to define changes to the basic resolution process that improve efficiency as much as possible.

The Motivation for Caching: Locality of Reference

A computer science principle called *locality of reference* describes two common phenomena related to how computers (and networks) are used. The first, sometimes called *spatial locality of reference*, observes that a resource is more likely to be referenced if it is near another resource that was recently referenced. The second, *temporal locality of reference*, says a resource is more likely to be accessed if it was recently accessed.

We can observe both of these phenomenon by using the example of browsing the Web. To observe spatial locality of reference, notice what happens when you visit a site such as <http://www.tcpipguide.com>. The initial request asks the server for the main index document of The TCP/IP Guide. However, that document contains links to several images and other items, all of which are **also** located at the domain “tcpipguide.com”. When your browser asks for the main document, it will shortly thereafter also ask for a number of graphics. Of course, as you navigate the site, you will click links to go to other Web pages. Again here, most of these will also be at the same domain, “tcpipguide.com”.

What this means is that if we resolve a particular domain name, it is likely that we will need to resolve it again very soon in the future. It would be silly to have to interrogate the same domain server dozens of times, each asking it to resolve the same name.

The second phenomenon, *temporal locality of reference*, is one you have probably noticed yourself. You are far more likely to access a resource you have used recently than one you have not looked at in a year. This means that maintaining information about recently-used resources can be inherently advantageous.

Name Resolver Caching

These two phenomena are the rationale for caching in the computer world in general, and as we have seen, in DNS servers in particular. The same advantages applies to resolvers, and so many of them perform caching also, in a way rather similar to [how it is done in servers](#). On a particular client computer, once a particular name is resolved, it is cached and remains ready for the next time it is needed. Again, this eliminates traffic and load on DNS servers. (Note however that not all resolvers perform caching.)

You might be wondering why we bother having caching on both resolvers and servers. This is not “redundant”, as it may appear. Or rather, it's redundant, but in a good way. To understand why, we much recognize that a fundamental trade-off in caching is that a cache provides better performance the **closer** it is the requestor of the data, but better coverage the **further** it is from the user.

If resolvers didn't cache results but our local server did, we could get the information from the server's cache, but it would require waiting for the exchange of a query and response. The resolver's cache is "closer" to the user and so more efficient. At the same time, this doesn't obviate the need for caching at our network's local DNS server. The server is further away from the user than the resolver, but its cache is shared by many machines. They can all benefit from its cache, so that if I look up a particular name and then someone else does a few minutes later, they can use my cached resolution even though they are typing it for the first time.

Caching by name resolvers follows the same general principles and rules as caching by name servers. The amount of time a resource record is specified by its *Time To Live* figure. Also, resolvers will not cache the results of certain queries, such as reverse lookups, and may also not cache a resolution if they suspect that for whatever reason the data returned is unreliable or corrupted.



Key Concept: In addition to the caching performed by DNS name servers, many (but not all) DNS resolvers also cache the results of recent resolution requests. This cache is checked prior to beginning a name resolution, to save time when multiple requests are made for the same name.

Local Resolution

One other area where resolution efficiency can be improved is the special case where we are trying to resolve the names of computers in our own organizations. Suppose that I, an employee at XYZ Industries, want to get some sales information using FTP from "sales.xyzindustries.com". My FTP client will invoke my local resolver to resolve that name, by sending it to our local DNS server. Now, would it be smart for that server, which is here inside the company, to start the resolution process up at the root name server? Not really.

The local DNS server that accepts local resolution requests from resolvers on the network may in fact **be** the authoritative name server for "sales.xyzindustries.com". In other cases, it may know how to answer certain resolution requests directly. Obviously, it makes sense for the server to check to see if it can answer a resolver's query before heading up to the root server, since this provides a faster answer to the client and saves internetwork traffic. This is called *local resolution*.

Most DNS servers will perform this check to see if they have the information needed for a request before commencing the "formal" top-down resolution process. The exception is DNS servers that do not maintain information about any zones: *caching-only servers*. In some cases, DNS resolvers on client machines may also have access to certain local zone information, in which case they can use it instead of sending a resolution query at all.

There's one more thing I also want to point out: most operating systems also support the use of the old [host table mechanism](#), which can be useful for local machines on a network. If a host has a host table, the resolver will check the host table to see if it can find a mapping for a name before it will bother with the more time-consuming DNS resolution process. This is not technically part of DNS, but is often used in conjunction with it.

DNS Name Resolution Process

In the previous topics I have described [what name resolvers do](#), explained [the basic top-down resolution process using iterative and recursive resolution](#), and discussed how [local resolution and caching](#) are used to improve resolution performance. Now I would like to tie all this background material together and finally show you how the name resolution process works as a whole!

As usual, the best way to do this is by example. Here, I will actually combine two examples I have used earlier: the fictitious company “XYZ Industries” and the non-existent college, Googleplex University. Let's say that XYZ Industries runs its own DNS servers for the “xyzindustries.com” zone. The master name server is called “ns1.xyzindustries.com”, and the slave is, ta-da, “ns2.xyzindustries.com”. These are also used as local DNS servers for resolvers on client machines. We'll assume for this example that as is often the case, our DNS servers will accept recursive requests from machines within our company, but will *not* assume other machines will accept such requests. Let's also assume that both the server and resolver perform caching, and that the caches are empty.

Let's say that Googleplex University runs its own DNS servers for the “googleplex.edu” domain, as I gave in the example in [the topic describing DNS zones](#). There are three subdomains: finearts.googleplex.edu, compsci.googleplex.edu, and admin.googleplex.edu. Of these, compsci.googleplex.edu is in a separate zone with dedicated servers, while the other subdomains are in the “googleplex.edu” zone (this is shown in [Figure 240](#).)

Resolution Process Steps

Now, suppose you are an employee within XYZ Industries and one of your clients is in charge of the networking department at Googleplex U. You type into your Web browser the address of this department's Web server, “www.net.compsci.googleplex.edu”. In simplified terms, the procedure would involve the following set of steps ([Figure 245](#) shows the process graphically):

1. Your Web browser recognizes the request for a name and invokes your local resolver, passing to it the name “www.net.compsci.googleplex.edu”.
2. The resolver checks its cache to see if it already has the address for this name. If it does, it returns it immediately to the Web browser, but in this case we are assuming that it does not. The resolver also checks to see if it has a local [host table file](#). If so, it scans the file to see if this name has a static mapping. If so, it resolves the name using this information immediately. Again, let's assume it does not, since that would be boring.
3. The resolver generates a recursive query and sends it to “ns1.xyzindustries.com” (using that server's IP address, of course, which the resolver knows).

-
4. The local DNS server receives the request and checks *its* cache. Again, let's assume it doesn't have the information needed. If it did, it would return the information, marked "non-authoritative", to the resolver. The server also checks to see if it has in its zone resource records that can resolve "www.net.compsci.googleplex.edu". Of course it does not, in this case, since they are in totally different domains.
 5. "ns1.xyzindustries.com" generates an iterative request for the name and sends it to a root name server.
 6. The root name server does not resolve the name. It returns the name and address of the name server for the ".edu" domain.
 7. "ns1.xyzindustries.com" generates an iterative request and sends it to the name server for ".edu".
 8. The name server for ".edu" returns the name and address of the name server for the "googleplex.edu" domain.
 9. "ns1.xyzindustries.com" generates an iterative request and sends it to the name server for "googleplex.edu".
 10. The name server for "googleplex.edu" consults its resource records. It sees, however, that this name is in the "compsci.googleplex.edu" subdomain, which is in a separate zone. It returns the name server for that zone.
 11. "ns1.xyzindustries.com" generates an iterative request and sends it to the name server for "compsci.googleplex.edu".
 12. The name server for "compsci.googleplex.edu" is authoritative for "www.net.compsci.googleplex.edu". It returns the IP address for that host to "ns1.xyzindustries.com".
 13. "ns1.xyzindustries.com" caches this resolution. (Note that it will probably also cache some of the other name server resolutions that it received in steps #6, #8 and #10; I have not shown these explicitly.)
 14. The local name server returns the resolution to the resolver on your local machine.
 15. Your local resolver also caches the information.
 16. The local resolver gives the address to your browser.
 17. Your browser commences an HTTP request to the Googleplex machine's IP address.

Seems rather complicated and slow. Of course, computers work faster than you can read (or I can type, for that matter.) Even given that, the benefits of caching are obvious—if the name was in the cache of the resolver or the local DNS server, most of these steps would be avoided.

Changes to Resolution to Handle Special Cases

This example is highly simplified, and also only shows one possible way that servers might be set up. For one thing, it is possible that even though "compsci.googleplex.edu" is in a separate zone from "googleplex.edu", they might use the same server. In that case, one iteration in the process would be skipped. The example also above doesn't show what happens if an error occurs in the process.

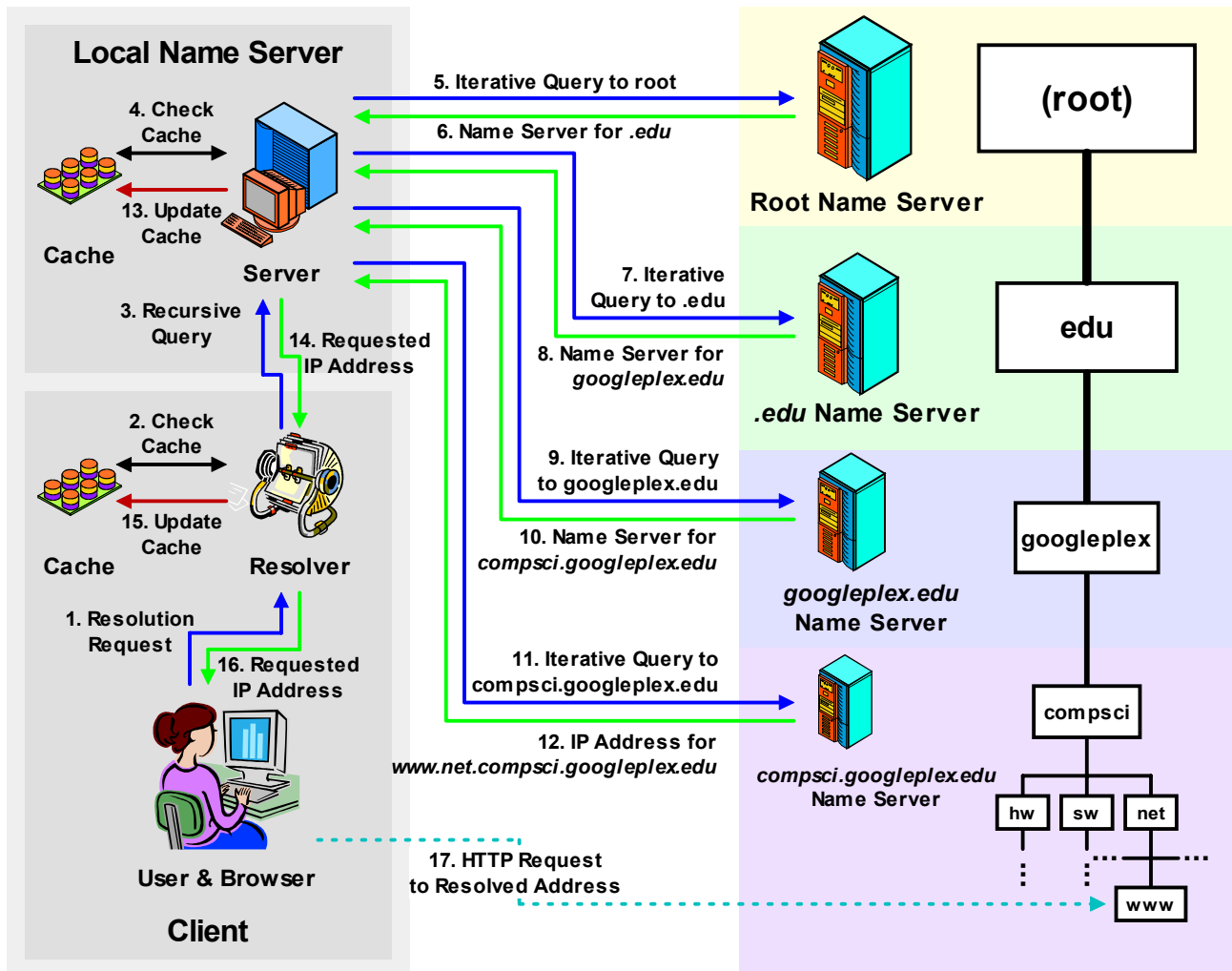

Figure 245: Example Of The DNS Name Resolution Process

This fairly complex example illustrates a typical DNS name resolution using both iterative and recursive resolution. The user types in a DNS name (“www.net.compsci.googleplex.edu”) into a Web browser, which causes a DNS resolution request to be made from her client machine’s resolver to a local DNS name server. That name server agrees to resolve the name recursively on behalf of the resolver, but uses iterative requests to accomplish it. These requests are sent to a DNS root name server, followed in turn by the name servers for “.edu”, “googleplex.edu” and ‘compsci.googleplex.edu”. The IP address is then passed to the local name server and then back to the user’s resolver and finally, her Web browser software.

If the domain name entered was an alias, indicated by a *CNAME* record, this would change the processing as well. *CNAME* records are used to allow a “constant” name for a device to be presented to the outside world while allowing the actual device that corresponds to the name to vary inside the organization. When a *CNAME* is used, it changes the name resolution process by adding an extra step: first we resolve the alias to the canonical name and then resolve the canonical name.

For example, Web servers are almost always named starting with “www.”, so at XYZ Industries we want people to be able to find our Web site at “www.xyzindustries.com”. However, the Web server may in fact be shared with other services on “bigserver.xyzindustries.com”.

We can set up a *CNAME* record to point “www.xyzindustries.com” to “bigserver.xyzindustries.com”. Resolution of “www” will result in a *CNAME* pointing to “bigserver”, which is then itself resolved. If in the future our business grows and we decide to upgrade our Web service to run on “bigserver.xyzindustries.com”, we just change the *CNAME* record and users are unaffected.

DNS Reverse Name Resolution Using the IN-ADDR.ARPA Domain

If most people had to boil down the core job of the Domain Name System to one function, they would probably say it was converting the names of objects into the numeric IP addresses associated with them. Well, they would if they knew much about DNS. For this reason, DNS is sometimes compared to a telephone book, or to telephone “411” service. There are certain problems with this analogy, but at the highest level it is valid. In both cases we take a name, consult a database (of one type or another), and produce from it a number that matches that name.

The Need for Reverse Name Resolution

In the real world, there are sometimes situations where you don't want to find the phone number that goes with a name, but rather, you have a phone number and want to know what person it belongs to. For example, this might happen if your telephone records the number of incoming calls but you don't have Caller ID to display the name associated with a number. You might also find a phone number on a piece of paper and not remember whose number it is.

Similarly, in the networking world, there are many situations where we have an IP address and want to know what name goes with it. For example, a World Wide Web server records the IP address of each device that connects to it in its server logs, but these numbers are generally meaningless to humans, who prefer to see the names that go with them.

A more serious example might be a hacker trying to break into your computer; by converting the IP address into a name you might be able to find out what part of the world he is from, what ISP he is using, and so forth. There are also many reasons why a network administrator might want to find out the name that goes with an address, for setup or troubleshooting purposes.

The Original Method: Inverse Querying

DNS originally included a feature called *inverse querying* that would allow this type of “opposite” resolution. A resolver could send a query which, instead of having a name filled in and a space for the server to fill in the IP address, had the IP address and a space for the name. The server would check its resource records and return the name to the resolver.

This works fine in theory, and even in practice if the internetwork is very small. However, remember that due to the distributed nature of DNS information, the biggest part of the job of resolution is in fact finding the right server. Now, in the case of regular resolution, we can easily find the right server by traversing the hierarchy of servers. This is possible because the servers are connected together following a hierarchy of names.

DNS servers are *not*, however, arranged based on IP address. This means that to use inverse queries, we have to use the right name server for the IP address we want to resolve into a name, with no easy way to find out what it is. Sure, we could try sending the inverse query to the authoritative DNS server for **every** zone in the hierarchy. If you tried, it would probably take you longer than it took to write this Guide. So let's not go there. The end result of all of this is that inverse queries were never popular except for local server troubleshooting. They were formally removed from DNS in November 2002 through the publishing of RFC 3425.

The IN-ADDR.ARPA Name Structure for Reverse Resolution

The problem here is that the servers are arranged by name and not by IP address. The solution, therefore, is as simple as it sounds: arrange the servers by IP address. This doesn't mean we remove the name hierarchy, or duplicate all the servers, or anything silly like that. Instead, we create an additional, numerical hierarchy that coexists with the name hierarchy. We then use this to find names from numbers, using a process commonly called *reverse name resolution*.

The name hierarchy for the Internet is implemented using a special domain called "IN-ADDR.ARPA", located within the reserved [".ARPA" top-level domain](#) ("IN-ADDR" stands for "INternet ADDRess". Recall that ".ARPA" was originally used to transition old Internet hosts to DNS, and is now used by the folks that run the Internet for various purposes.

A special numerical hierarchy is created within "IN-ADDR.ARPA" that covers the entire IP address space:

- ① At the first level within "IN-ADDR.ARPA" there are 256 subdomains called "0", "1", "2" and so on, up to "255". For example, "191.IN-ADDR.ARPA". (Actually there may not be all 256 of these since some IP addresses are reserved, but let's ignore that for now).
- ② Within each of the subdomains above, there are 256 further subdomains at the second level, numbered the same way. So for example, one of these would be "27.191.IN-ADDR.ARPA".
- ③ Again, there are 256 subdomains at the third level within each of the above, such as "203.27.191.IN-ADDR.ARPA"
- ④ Finally, there are 256 subdomains at the fourth level within each of the third-level subdomains, such as "8.203.27.191.IN-ADDR.ARPA".

This structure is illustrated in [Figure 246](#). As you can see, within "IN-ADDR.ARPA" we have created a name space that parallels the address space of the Internet Protocol. (Yes, this means there are several **billion** nodes and branches in this part of the Internet DNS name space!)

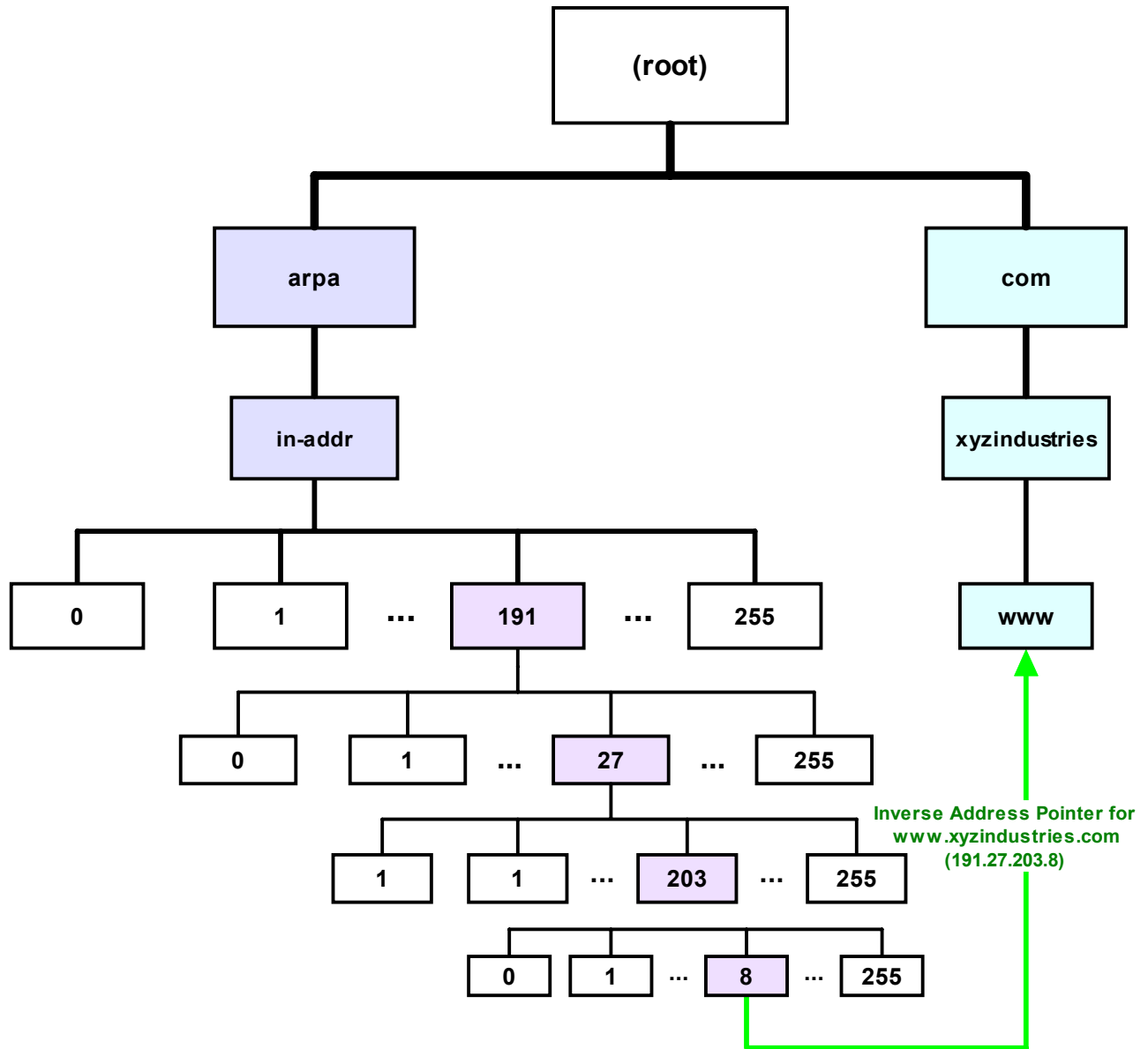

Figure 246: The DNS IN-ADDR.ARPA Reverse Name Resolution Hierarchy

The special “IN-ADDR.ARPA” hierarchy was created to allow easy reverse lookups of DNS names. “IN-ADDR.ARPA” contains 256 subdomains numbered 0 to 255, each of which has 256 subdomains numbered 0 to 255, and so forth, down four levels. Thus, each IP address is represented in the hierarchy. In this diagram I have shown as an example the DNS domain name “www.xyzindustries.com”. It would have a conventional resource record pointing to its IP address, 191.27.203.8, as well as a reverse resolution record at 8.203.27.191.IN-ADDR.ARPA, pointing to the domain name “www.xyzindustries.com”.

Resource Record Setup for Reverse Resolution

With the IN-ADDR.ARPA structure in place, we can now associate one entry in this name space with each entry in the “real” DNS name space. We do this using the “PTR” (pointer) resource record type. For example, if “www.xyzindustries.com” has the IP address 191.27.203.8, then the DNS server for its zone will have an address resource record indicating this. In master file text format, it will say something like this:

```
www.xyzindustries.com. A 191.27.203.8
```

However, there will also be the following entry for it within the IN-ADDR.ARPA domain:

```
8.203.27.191.IN-ADDR.ARPA PTR www.xyzindustries.com
```

(Remember that DNS names are case-insensitive, so the “IN-ADDR.ARPA” could also be given as “in-addr.arpa”).

Once this is done, reverse name resolution can be easily performed by doing a name resolution on “8.203.27.191.in-addr.arpa”. If we do this, a server for the “IN-ADDR.ARPA” domain will return to us the name “www.xyzindustries.com”. This is also shown in [Figure 246](#).

Why The IN-ADDR.ARPA Structure Is the Opposite of Normal IP Addresses

I’m sure you’ve noticed that the numbers are “backwards” in the IN-ADDR.ARPA domain. We’ve already seen the reason for this: name resolution proceeds from the least-specific to the most-specific element, going from right to left. In contrast, IP addresses have the least specific octet on the left, and the most specific on the right. Thus, we reverse them to maintain consistency with the DNS name space.

This immediately yields us one extra benefit. Just as we can delegate authority for portions of the regular name space, for example, letting “XYZ Industries” be in charge of everything in “xyzindustries.com”, we can also delegate authority for parts of the IN-ADDR.ARPA name space. For example, since MIT owns all IP addresses with a first octet of 18—at least I think they still do—it is possible that if MIT wanted to, they could control the “18.IN-ADDR.ARPA” domain as well for reverse queries. This would not be possible without reversing the octets as we have done.

Note that for this system to work reliably, it is essential that the data in the “regular” name space and the reverse name space remain consistent. Whenever a new DNS name is registered, an appropriate entry must be made within IN-ADDR.ARPA as well. Special procedures have been put into place to allow these pointer entries to be created automatically.



Related Information: A similar scheme using a different reverse domain is used for [DNS under IPv6](#).



Key Concept: Most name resolutions require that we transform a DNS domain name into an IP address. However, there are cases where we want to perform a *reverse name resolution*, by starting with an IP address and finding out what domain name matches it. This is difficult to do using the conventional DNS distributed name hierarchy, because there is no easy way to find the DNS server containing the entries for a particular IP address using the regular DNS name hierarchy. To this end, a special hierarchy called *IN-ADDR.ARPA* was set up for reverse name lookups. This hierarchy contains four levels of numerical subdomains structured so that each IP address has its own node. The node for an IP address contains an entry that points to the DNS domain name associated with that address.

DNS Electronic Mail Support and Mail Exchange (MX) Resource Records

Most savvy users of the Internet know that the Domain Name System exists, and usually associate it with the most common Internet applications. Of these applications, the “big kahuna” is of course the [World Wide Web](#). It's probably the case that the majority of DNS name resolution requests are spawned as a result of Web server domain names being typed into browsers billions of times a day, as well as requests for named pages generated by both user mouse clicks and Web-based applications.

Of course, DNS is not tied specifically to any one application. We can specify names in any place where an IP address would go. For example, you can use a DNS name instead of an address for an [FTP](#) client, or even for a troubleshooting utility like [traceroute](#) or [ping](#). The resolver will in each case take care of translating the name for you.

There's one application that has always used DNS, but it's one that doesn't usually spring to mind when you think about DNS: [electronic mail](#). Electronic mail is in fact more reliant on DNS than just about any other TCP/IP application. Consider that while you may *sometimes* type in an IP address for a command like [traceroute](#), or even type it into a browser, you probably have never sent anyone mail by entering “joe@14.194.29.60” into your e-mail client. At least I never have in over a dozen years being online. You instead type “joe@xyzindustries.com”, and DNS takes care of figuring out where electronic mail for XYZ Industries is to go.

Special Requirements for Electronic Mail Name Resolution

Name resolution for electronic mail addresses is different from other applications in DNS, for [three reasons that I describe in the overview topic on TCP/IP e-mail addressing and address resolution](#). To summarize: first, we may not want electronic mail to go to the exact

machine specified by the address; second, we need to be able to change server names without changing everyone's e-mail address; and third, we need to be able to support multiple servers for handling mail.

For example, XYZ Industries might want to use a dedicated mail server called “mail.xyzindustries.com” to handle incoming mail, but actually construct all of its e-mail addresses to use “@xyzindustries.com”. This makes addresses shorter, and allows the server's name to be changed without affecting user addresses. If the company wishes, it might decide to use two servers, “mail1.xyzindustries.com” and “mail2.xyzindustries.com”, for redundancy, and again have just “@xyzindustries.com” for addresses.

The Mail Exchange (MX) Record and Its Use

To allow the flexibility needed for these situations, a special DNS resource record type is defined called a *mail exchange (MX)* record. Each *MX* record specifies a particular mail server that is to be used to handle incoming e-mail for a particular domain. Once this record is established, resolution of electronic mail messages is pretty much similar to how it works for regular resolution. Suppose we want to send an e-mail to “joe@xyzindustries.com”. The process, roughly, is as follows:

1. Our e-mail client invokes the resolver on our local machine to perform an e-mail resolution on “xyzindustries.com”.
2. Our local resolver and local DNS server follow the process described in [the topic on DNS name resolution](#) to find the authoritative server for “xyzindustries.com”, which is “ns1.xyzindustries.com”.
3. “ns1.xyzindustries.com” finds the *MX* record for “xyzindustries.com” and replies back indicating that “mail.xyzindustries.com” should be used for e-mail.

Of course, the e-mail client can't actually send anything to “mail.xyzindustries.com”; it needs its IP address. So, it would then have to resolve that name. Of course, this resolution request will likely end up right back at the same DNS name server that just handled the *MX* request. To eliminate the inefficiency of two separate resolutions, the DNS name server can combine the information. In our example above, “ns1.xyzindustries.com” will include the *A (Address)* resource record for “mail.xyzindustries.com” in the *Additional* section of the DNS message that it sends in step 3 above.

It is also possible to specify multiple *MX* records for a particular domain, each pointing to a different mail server's name. This provides redundancy, so if there is a problem with one mail server, another can pick up the slack. DNS allows each mail server to be specified with a *preference* value, so you can clearly indicate which is the main mail server, which is the first backup, the second backup, and so on. The DNS server will choose the mail server with the lowest preference value first, then the next highest one, and so on.



Key Concept: Since electronic mail is sent using host names and not IP addresses, DNS contains special provisions to support the transfer of e-mail between sites. Special *mail exchange (MX)* DNS resource records are set up that contain the names of mail servers that a domain wants to use for handling incoming e-mail. Before sending e-mail to a site, a device performs a name resolution to get that site's MX record, so it knows where to send the message.

Obsolete Electronic Mail Resource Records

Note that RFC 1035 originally defined several other resource record types related to electronic mail as well: the *mailbox (MB)*, *mail group (MG)* and *mail rename (MR)* resource records. These are called "experimental" in the standard. I think the experiment failed, whatever it was, because I don't believe these are used today. There are also two even older mail-related resource records, *mail destination (MD)* and *mail forwarder (MF)*, which must have been used at one time but were already obsolete at the time RFC 1035 itself was written.



DNS Messaging and Message, Resource Record and Master File Formats

Networking is all about the communication of information between connected devices. In the case of the Domain Name System, information about names and objects on the internetwork is exchanged during each of the many types of operations DNS performs. This involves sending *messages* between devices. Like most protocols, DNS uses its own set of messages with distinct field formats, and follows a particular set of rules for generating them and transporting them over the internetwork.

In this section I explain how messages are generated and sent in DNS, and also describe the formats used for messages and resource records. I begin with an overview discussion of DNS messages and how they are generated and transported. I provide an overview of the general DNS message format, and the five sections it contains. I describe the notation used for names and the special compression method that helps keep DNS messages down in size. I then show the fields in the DNS message header and question section. I illustrate the common field format used for all resource records, and the specific fields in the most important record types. I conclude with a description of the format used for DNS text master files.

DNS Message Generation and Transport

In the preceding sections we have explored the many different tasks that DNS servers and resolvers perform: regular name resolution, reverse name resolution, e-mail resolution, zone transfers, and more. Each of these operations requires that information be exchanged between a pair of DNS devices. Like so many other TCP/IP protocols, DNS is designed to accomplish this information transfer using a *client/server* model. All DNS exchanges begin with a client sending a request, and a server responding back with an answer.

DNS Client/Server Messaging Overview

In the [overview topic on TCP/IP's client/server nature](#), I explained a potential source of confusion regarding these terms: the fact that they refer to hardware roles, software roles and transactional roles. This issue definitely applies when it comes to DNS. We've already seen that DNS implementation consists of two sets of software elements: [resolvers](#) that act as clients and [name servers](#) that are of course the servers. Resolver software usually runs on client machines like PCs, while name server software often runs on dedicated server hardware.

However, these designations are based on the overall role of the hardware and software. From a messaging viewpoint, the “client” is the initiator of the communication, regardless of what type of machine does this initiating, and the “server” is the device that responds to the client. A resolver usually acts as a client and a name server as a server. However, in a particular exchange a DNS name server can in fact act as a client, in at least two cases. First, in [recursive name resolution](#), a server generates requests to other servers and therefore acts as a client. Second, in administrative functions like [zone transfers](#), one server acts like a client and sends a request to another server. (There are no cases in DNS that I know of where a resolver acts as a server, incidentally.)

Most transactions in DNS consist of the exchange of a single query message and a single response message. The device acting as client for the transaction creates the query and sends it to the server; the server then sends back a reply. This is done through the process described in the next topic. In certain cases where a great deal of data needs to be sent, such as zone transfers, the server may send back multiple messages. Multiple such transactions may be required to perform a complete name resolution, as [my example of the DNS resolution process](#) demonstrated.

DNS Message Transport Using UDP and TCP

TCP/IP of course has two different protocols for data transfer: the [User Datagram Protocol \(UDP\)](#) and [Transmission Control Protocol \(TCP\)](#). UDP and TCP “share” level 4 in TCP/IP because they are so different in terms of capabilities and operation. Some application protocols need the services of TCP and can use it to take advantage of them, while others are better off with the simpler UDP. DNS is itself a perfect example of the [valid reasons for having both UDP and TCP in the protocol suite](#), because it uses **both**.

UDP Message Transport

UDP is a simple connectionless protocol that provides no real features but is very fast. It is ideally suited for small, quick exchanges of information, and can be faster than TCP because there is no need to establish a connection. This makes it a good choice for most of the conventional queries used in DNS, because they are normally very short, and fast data exchange is important. For this reason, the DNS standards recommend use of UDP for queries and replies as part of regular and reverse name resolution. UDP DNS messages are limited to 512 bytes; longer messages are truncated and a [special bit in the header](#) is set to indicate that this has occurred. If a message being truncated causes a problem for its recipient, the query must be repeated using TCP, as described below.



Note: The 512 byte limit on DNS UDP messages can be surpassed if the optional *Extension Mechanisms for DNS (EDNS0)* are implemented. These are described in RFC 2671.

TCP Message Transport

Since UDP does not provide reliable delivery of messages, DNS clients must keep track of requests they have sent. If no response is received after a particular amount of time, the request must be retransmitted. The need to take care of these details is considered an acceptable trade-off for the lower setup costs involved with UDP, such as not requiring a connection. The rate at which retransmissions is sent is usually set at a minimum of 2 to 5 seconds to prevent excessive DNS traffic on the internetwork.

For certain special DNS transactions, UDP is simply inappropriate. The most common example of such a transaction is a zone transfer. While the query for a zone transfer is small in size, the amount of data sent in response can be quite large. The limit of 512 bytes for UDP is not even close to enough. Furthermore, we really do need to make sure that a zone

transfer is accomplished reliably and with flow control and other data transfer management features, or we risk having corrupted zone information in our secondary DNS server databases.

The solution is to use TCP for these types of exchanges. TCP allows messages to be of arbitrary length, and as a [connection-oriented, acknowledged, reliable protocol](#), automatically provides the mechanisms we need to ensure that zone transfers and other lengthy operations complete successfully. The cost is the small amount of overhead needed to establish the connection, but since zone transfers are infrequent (compared to the sheer volume of regular name resolutions) this is not a problem.

You can see how DNS nicely illustrates the roles of both TCP and UDP in TCP/IP. Since both transport protocols can be used, name servers listen for both UDP and TCP requests on the same [well-known port number](#), 53. The device acting as the client uses an [ephemeral port number](#) for the transaction. All DNS messages are sent [unicast](#) from one device directly to another.



Key Concept: DNS uses both UDP and TCP to send messages. Conventional message exchanges are “short and sweet” and thus well-suited to the use of the very fast UDP; DNS itself handles the detection and retransmission of lost requests. For larger or more important exchanges of information, especially zone transfers, TCP is used—both for its reliability and its ability to handle messages of any size.

DNS Message Processing and General Message Format

The [previous topic](#) discussed DNS message exchanges and the fact that they are all based on the principle of client/server computing. In a particular exchange, one device acts as a client, initiating the communication by sending a query; the other acts as the server by responding to the query with an answer. This “query/response” behavior is an integral part of DNS, and is reflected in the format used for DNS messages.

A common message format is used for DNS queries and responses. This message format contains five sections that provide a place for the query asked by the client; the answer(s) provided by the server; and header information that controls the entire process. [Table 169](#) describes the DNS general message format, providing a brief summary of each of its sections and how they are used. You can also see a simplified illustration of the message format in [Figure 247](#).

Table 169: DNS General Message Format (Page 1 of 2)

Section Name	Description
Header	Contains fields that describe the type of message and provide important information about it. Also contains fields that indicate the number of entries in the other sections of the message.
Question	Carries one or more “questions”, that is, queries for information being sent to a DNS name server.

Table 169: DNS General Message Format (Page 2 of 2)

Section Name	Description
Answer	Carries one or more resource records that answer the question(s) indicated in the <i>Question</i> section above.
Authority	Contains one or more resource records that point to authoritative name servers that can be used to continue the resolution process.
Additional	Conveys one or more resource records that contain additional information related to the query that is not strictly necessary to answer the queries (questions) in the message.

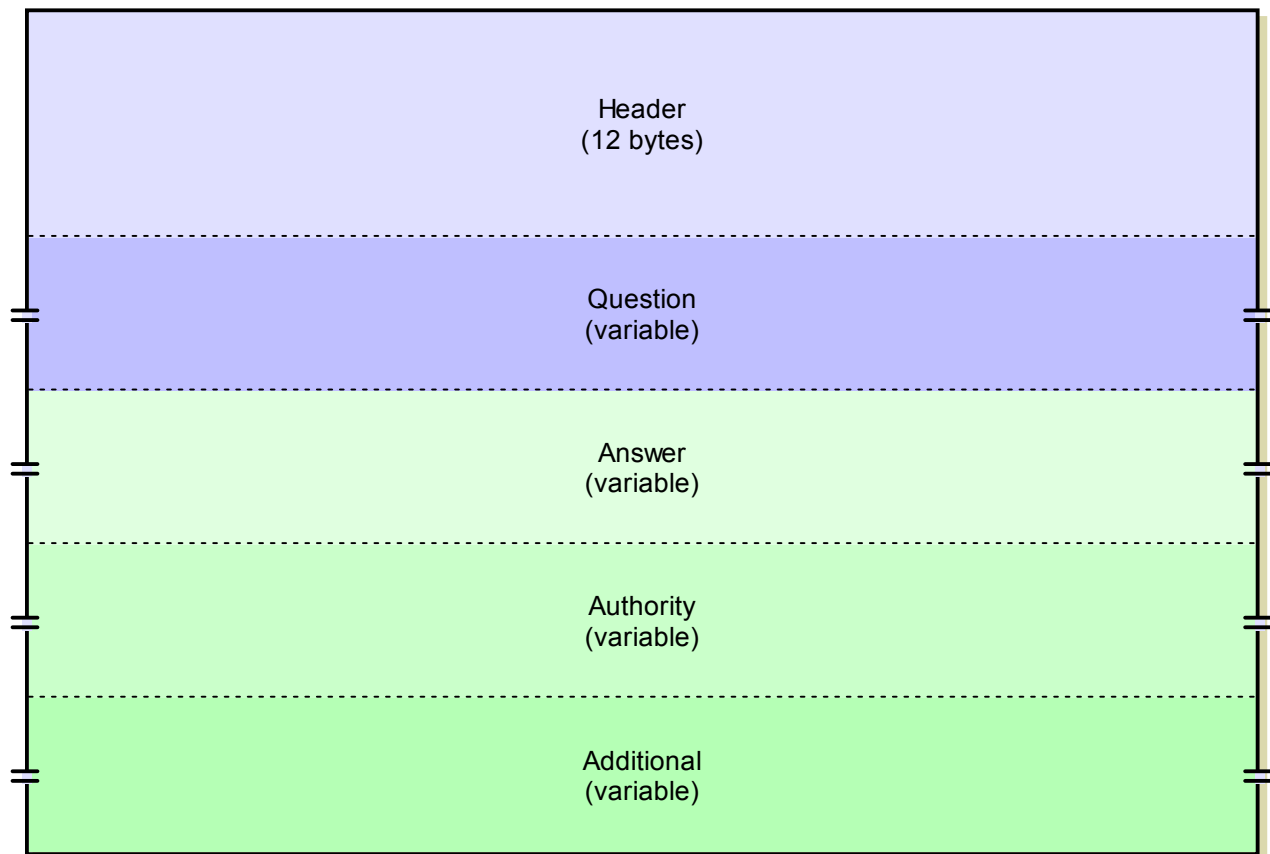

Figure 247: DNS General Message Format

Header and Question Section

The *Header* is always present in all messages and is fixed in length. In addition to containing important DNS control information, it has a flag (*QR*) that indicates whether a message is a query or a response. It also has four “count” fields that tell the recipient the number of entries in the other four sections.

When a client initiates a query, it creates a message with the fields in the *Header* filled in, and one or more queries (requests for information) in the *Question* section. It sets the *QR* flag to 0 to indicate that this is a query, and places a number in the *QDCount* field of the header that indicates the number of questions in the *Question* section. The number of entries in the other sections are usually zero, so their “count” fields (*ANCount*, *NSCount* and *ARCount*) are set to 0 in the header. (While more than one question can be put into a query, usually only one is included.)

When the server receives the query it processes it and performs the information retrieval operation requested (if it can). It then uses the query as the basis for its response message. The *Header* and *Question* sections are copied to the response message, and the *QR* flag is set to 1 to indicate that the message is a reply. Certain fields are also changed in the header to provide information back to the client. For example, the server sets the *RCode* (*Response Code*) field to indicate whether the query was successful or if an error occurred, and if one did occur, to indicate what the problem was. [The next topic](#) shows all the *Header* fields and indicates how each is used by both client and server.

Resource Record Sections: Answer, Authority and Additional

The server is also responsible for filling in the other three sections of the message: *Answer*, *Authority* and *Additional*. These sections share the same basic format, each carrying one or more resource records that use a common record format. The number of records in each section is indicated using the “count” fields in the message header. The sections differ only in terms of the types of records they carry. *Answer* records are directly related to the question asked, while *Authority* records carry resource records that identify other name servers. *Authority* records are thus the means by which name servers are hierarchically “linked” when the server doesn't have the information the client requested.

The *Additional* section exists for the specific purpose of improving DNS efficiency. There are cases where a server supplies an answer to a query that it has reason to believe will lead to a subsequent question that the server can also answer. For example, suppose a server provides the name of another name server in the *Authority* section (an *NS* resource record). The client may not have the address for that server, which would mean it has to perform an extra name resolution to contact the referenced server. If the server providing the *NS* record already knows the IP address for this name server, it can include it in the *Additional* section. The same goes for a server providing an *MX* record as I explained in [the topic on DNS mail support](#).



Key Concept: DNS uses a general message format for all messages. It consists of a fixed 12-byte *Header*, a *Question* section that contains a query, and then three additional sections that can carry resource records of different types. The *Answer* section usually contains records that directly answer the *Question* of the message; the *Authority* section holds the names of name servers being sent back to the client, and the *Additional* section holds extra information that may be of value to the client, such as the IP address of a name server mentioned in the *Authority* section.



Note: The special *Notify* and *Update* messages use a different format than the regular DNS query/response messages. These special messages (whose use is described in [the topic on DNS server enhancements](#)) are based on the regular format but with the meanings of certain fields changed. You can find these field formats in RFC 1996 and RFC 2136 respectively.

DNS Message Header and Question Section Format

The client/server information exchange in DNS is facilitated using query/response messaging. Both queries and responses have the same general format, containing up to five individual sections carrying information. Of these, two are usually found in both queries and responses: the *Header* section and the *Question* section. I will start exploring the detailed format of DNS messages by looking at these two sections; the next topic will cover the resource record formats used by servers for the other three message sections.

DNS Message Header Format

The header is the most important part of any message, since it is where critical control fields are carried. In DNS messages, the *Header* section carries several key control flags, and is also where we find out which of the other sections are even being used in the message. Examining the *Header* can help us understand several of the nuances of how messaging works in DNS.

The format of the *Header* section used in all DNS messages is described in detail in [Table 170](#) and shown in [Figure 248](#). Where fields are used differently by the client and server in an exchange, I have mentioned in the table how the use is differentiated between the two.

Table 170: DNS Message Header Format (Page 1 of 4)

Field Name	Size (bytes)	Description
<i>ID</i>	2	Identifier: A 16-bit identification field generated by the device that creates the DNS query. It is copied by the server into the response, so it can be used by that device to match that query to the corresponding reply received from a DNS server. This is used in a manner similar to how the <i>Identifier</i> field is used in many of the ICMP message types .
<i>QR</i>	1/8 (1 bit)	Query/Response Flag: Differentiates between queries and responses. Set to 0 when the query is generated; changed to 1 when that query is changed to a response by a replying server.

Table 170: DNS Message Header Format (Page 2 of 4)

Field Name	Size (bytes)	Description																					
Opcode	1/2 (4 bits)	<p>Operation Code: Specifies the type of query the message is carrying. This field is set by the creator of the query and copied unchanged into the response:</p> <table border="1"> <thead> <tr> <th>Opcode Value</th> <th>Query Name</th> <th>Description</th> </tr> </thead> <tbody> <tr> <td>0</td> <td>QUERY</td> <td>A standard query.</td> </tr> <tr> <td>1</td> <td>IQUERY</td> <td>An inverse query; now obsolete. RFC 1035 defines the inverse query as an optional method for performing inverse DNS lookups, that is, finding a name from an IP address. Due to implementation difficulties, the method was never widely deployed, however, in favor of reverse mapping using the IN-ADDR.ARPA domain. Use of this Opcode value was formally obsoleted in RFC 3425, November 2002.</td> </tr> <tr> <td>2</td> <td>STATUS</td> <td>A server status request.</td> </tr> <tr> <td>3</td> <td>(reserved)</td> <td>Reserved, not used.</td> </tr> <tr> <td>4</td> <td>NOTIFY</td> <td>A special message type added by RFC 1996. It is used by a primary (master, authoritative) server to tell secondary servers that data for a zone has changed and prompt them to request a zone transfer. See the discussion of DNS server enhancements for more details.</td> </tr> <tr> <td>5</td> <td>UPDATE</td> <td>A special message type added by RFC 2136 to implement “dynamic DNS”. It allows resource records to be added, deleted or updated selectively. See the discussion of DNS server enhancements for more details.</td> </tr> </tbody> </table>	Opcode Value	Query Name	Description	0	QUERY	A standard query.	1	IQUERY	An inverse query; now obsolete. RFC 1035 defines the inverse query as an optional method for performing inverse DNS lookups, that is, finding a name from an IP address. Due to implementation difficulties, the method was never widely deployed, however, in favor of reverse mapping using the IN-ADDR.ARPA domain . Use of this Opcode value was formally obsoleted in RFC 3425, November 2002.	2	STATUS	A server status request.	3	(reserved)	Reserved, not used.	4	NOTIFY	A special message type added by RFC 1996. It is used by a primary (master, authoritative) server to tell secondary servers that data for a zone has changed and prompt them to request a zone transfer. See the discussion of DNS server enhancements for more details.	5	UPDATE	A special message type added by RFC 2136 to implement “dynamic DNS”. It allows resource records to be added, deleted or updated selectively. See the discussion of DNS server enhancements for more details.
		Opcode Value	Query Name	Description																			
		0	QUERY	A standard query.																			
		1	IQUERY	An inverse query; now obsolete. RFC 1035 defines the inverse query as an optional method for performing inverse DNS lookups, that is, finding a name from an IP address. Due to implementation difficulties, the method was never widely deployed, however, in favor of reverse mapping using the IN-ADDR.ARPA domain . Use of this Opcode value was formally obsoleted in RFC 3425, November 2002.																			
		2	STATUS	A server status request.																			
		3	(reserved)	Reserved, not used.																			
		4	NOTIFY	A special message type added by RFC 1996. It is used by a primary (master, authoritative) server to tell secondary servers that data for a zone has changed and prompt them to request a zone transfer. See the discussion of DNS server enhancements for more details.																			
		5	UPDATE	A special message type added by RFC 2136 to implement “dynamic DNS”. It allows resource records to be added, deleted or updated selectively. See the discussion of DNS server enhancements for more details.																			
AA	1/8 (1 bit)	<p>Authoritative Answer Flag: This bit is set to 1 in a response to indicate that the server that created the response is authoritative for the zone in which the domain name specified in the Question section is located. If it is 0, the response is non-authoritative.</p>																					
TC	1/8 (1 bit)	<p>Truncation Flag: When set to 1, indicates that the message was truncated due to its length being longer than the maximum permitted for the type of transport mechanism used. TCP doesn't have a length limit for messages, while UDP messages are limited to 512 bytes, so this bit being sent usually is an indication that the message was sent using UDP and was too long to fit. The client may need to establish a TCP session to get the full message. On the other hand, if the portion truncated was part of the <i>Additional</i> section, it may choose not to bother.</p>																					
RD	1/8 (1 bit)	<p>Recursion Desired: When set in a query, requests that the server receiving the query attempt to answer the query recursively, if the server supports recursive resolution. The value of this bit is not changed in the response.</p>																					

Table 170: DNS Message Header Format (Page 3 of 4)

Field Name	Size (bytes)	Description																																				
RA	1/8 (1 bit)	Recursion Available: Set to 1 or cleared to 0 in a response to indicate whether the server creating the response supports recursive queries. This can then be noted by the device that sent the query for future use.																																				
Z	3/8 (3 bits)	Zero: Three reserved bits set to zero.																																				
RCode	1/2 (4 bits)	<p>Response Code: Set to zero in queries, then changed by the replying server in a response to convey the results of processing the query. This field is used to indicate if the query was answered successfully, or if some sort of error occurred:</p> <table border="1"> <thead> <tr> <th>RCode Value</th> <th>Response Code</th> <th>Description</th> </tr> </thead> <tbody> <tr> <td>0</td> <td><i>No Error</i></td> <td>No error occurred.</td> </tr> <tr> <td>1</td> <td><i>Format Error</i></td> <td>The server was unable to respond to the query due to a problem with how it was constructed.</td> </tr> <tr> <td>2</td> <td><i>Server Failure</i></td> <td>The server was unable to respond to the query due to a problem with the server itself.</td> </tr> <tr> <td>3</td> <td><i>Name Error</i></td> <td>The name specified in the query does not exist in the domain. This code can be used by an authoritative server for a zone (since it knows all the objects and subdomains in a domain) or by a caching server that implements negative caching.</td> </tr> <tr> <td>4</td> <td><i>Not Implemented</i></td> <td>The type of query received is not supported by the server.</td> </tr> <tr> <td>5</td> <td><i>Refused</i></td> <td>The server refused to process the query, generally for policy reasons and not technical ones. For example, certain types of operations, such as zone transfers, are restricted. The server will honor a zone transfer request only from certain devices.</td> </tr> <tr> <td>6</td> <td><i>YX Domain</i></td> <td>A name exists when it should not.</td> </tr> <tr> <td>7</td> <td><i>YX RR Set</i></td> <td>A resource record set exists that should not.</td> </tr> <tr> <td>8</td> <td><i>NX RR Set</i></td> <td>A resource record set that should exist does not.</td> </tr> <tr> <td>9</td> <td><i>Not Auth</i></td> <td>The server receiving the query is not authoritative for the zone specified.</td> </tr> <tr> <td>10</td> <td><i>Not Zone</i></td> <td>A name specified in the message is not within the zone specified in the message.</td> </tr> </tbody> </table>	RCode Value	Response Code	Description	0	<i>No Error</i>	No error occurred.	1	<i>Format Error</i>	The server was unable to respond to the query due to a problem with how it was constructed.	2	<i>Server Failure</i>	The server was unable to respond to the query due to a problem with the server itself.	3	<i>Name Error</i>	The name specified in the query does not exist in the domain. This code can be used by an authoritative server for a zone (since it knows all the objects and subdomains in a domain) or by a caching server that implements negative caching.	4	<i>Not Implemented</i>	The type of query received is not supported by the server.	5	<i>Refused</i>	The server refused to process the query, generally for policy reasons and not technical ones. For example, certain types of operations, such as zone transfers, are restricted. The server will honor a zone transfer request only from certain devices.	6	<i>YX Domain</i>	A name exists when it should not.	7	<i>YX RR Set</i>	A resource record set exists that should not.	8	<i>NX RR Set</i>	A resource record set that should exist does not.	9	<i>Not Auth</i>	The server receiving the query is not authoritative for the zone specified.	10	<i>Not Zone</i>	A name specified in the message is not within the zone specified in the message.
RCode Value	Response Code	Description																																				
0	<i>No Error</i>	No error occurred.																																				
1	<i>Format Error</i>	The server was unable to respond to the query due to a problem with how it was constructed.																																				
2	<i>Server Failure</i>	The server was unable to respond to the query due to a problem with the server itself.																																				
3	<i>Name Error</i>	The name specified in the query does not exist in the domain. This code can be used by an authoritative server for a zone (since it knows all the objects and subdomains in a domain) or by a caching server that implements negative caching.																																				
4	<i>Not Implemented</i>	The type of query received is not supported by the server.																																				
5	<i>Refused</i>	The server refused to process the query, generally for policy reasons and not technical ones. For example, certain types of operations, such as zone transfers, are restricted. The server will honor a zone transfer request only from certain devices.																																				
6	<i>YX Domain</i>	A name exists when it should not.																																				
7	<i>YX RR Set</i>	A resource record set exists that should not.																																				
8	<i>NX RR Set</i>	A resource record set that should exist does not.																																				
9	<i>Not Auth</i>	The server receiving the query is not authoritative for the zone specified.																																				
10	<i>Not Zone</i>	A name specified in the message is not within the zone specified in the message.																																				
QDCount	2	Question Count: Specifies the number of questions in the <i>Question</i> section of the message.																																				
ANCount	2	Answer Record Count: Specifies the number of resource records in the <i>Answer</i> section of the message.																																				

Table 170: DNS Message Header Format (Page 4 of 4)

Field Name	Size (bytes)	Description
NSCount	2	Authority Record Count: Specifies the number of resource records in the <i>Authority</i> section of the message. (“NS” stands for “name server”, of course. ☺)
ARCount	2	Additional Record Count: Specifies the number of resource records in the <i>Additional</i> section of the message.

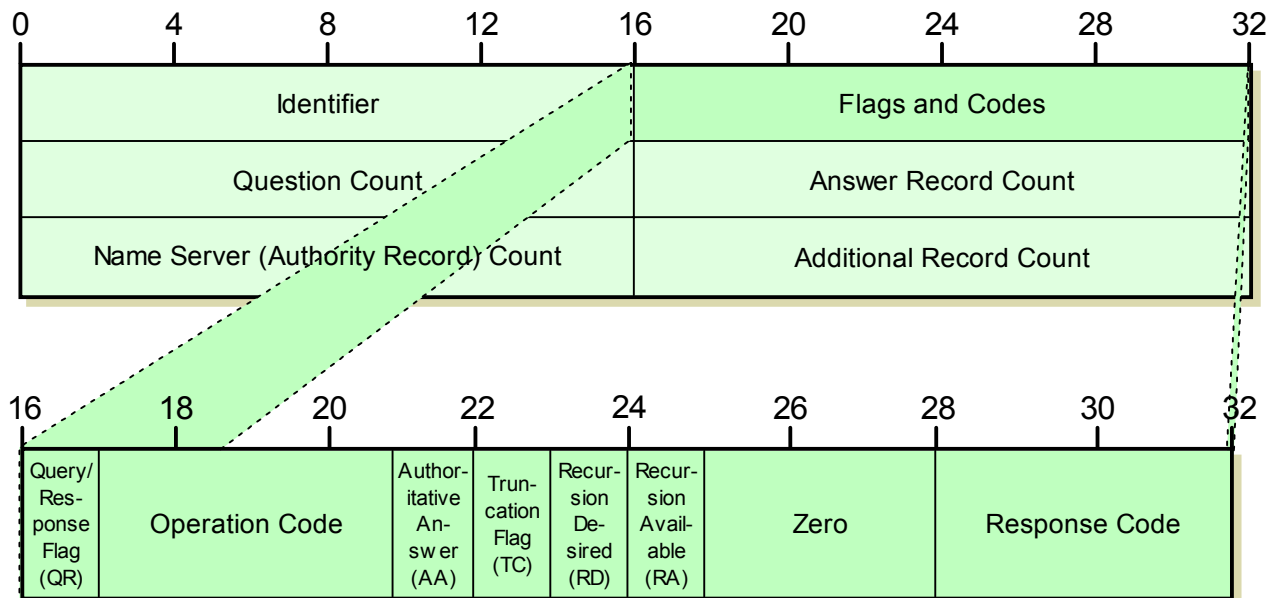

Figure 248: DNS Message Header Format

Note that the current lists of valid question types, query operation codes and response codes are maintained by IANA as one of its many lists of Internet parameters. Response codes 0 to 5 are part of “regular” DNS and are defined in RFC 1035; codes 6 to 10 implement dynamic DNS and are defined in RFC 2136.

DNS Question Section Format

DNS queries always contain at least one entry in the *Question* section that specifies what the client in the exchange is trying to find out. These entries are copied to the response message unchanged, for reference on the part of the client if needed. [Table 171](#) and [Figure 249](#) show the format used for each entry in the *Question* section of a DNS message.

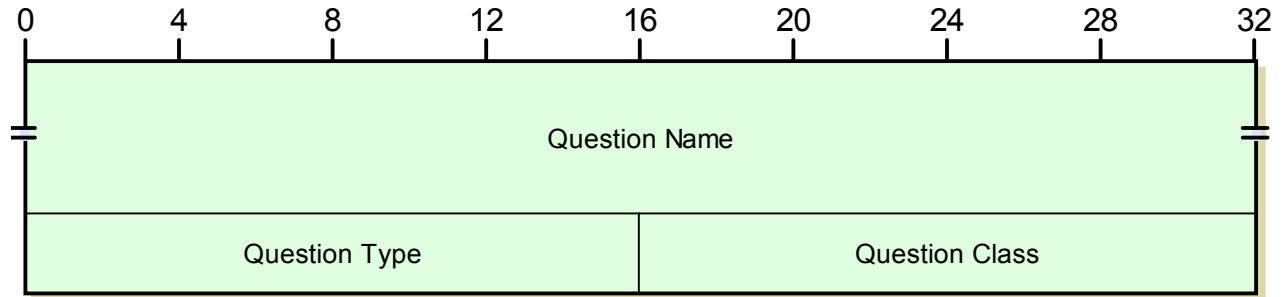

Figure 249: DNS Message *Question* Section Format

Table 171: DNS Message *Question* Section Format (Page 1 of 2)

Field Name	Size (bytes)	Description
<i>QName</i>	Variable	<i>Question Name</i> : Contains the object, domain or zone name that is the subject of the query, encoded using standard DNS name notation .

Table 171: DNS Message Question Section Format (Page 2 of 2)

Field Name	Size (bytes)	Description																		
QType	2	<p>Question Type: Specifies the type of question being asked by the device acting as a client. This field may contain a code number corresponding to a particular type of resource record being requested—Table 167 contains the numbers for the most common resource records. If so, this means the client is asking for that type of record to be sent for the domain name listed in <i>QName</i>. The <i>QType</i> field may also contain one of the following codes that correspond to “special” types of requests:</p> <table border="1"> <thead> <tr> <th>QType Value</th> <th>Question Type</th> <th>Description</th> </tr> </thead> <tbody> <tr> <td>251</td> <td><i>IXFR</i></td> <td>A request for an incremental (partial) zone transfer, per RFC 1995.</td> </tr> <tr> <td>252</td> <td><i>AXFR</i></td> <td>A request for a zone transfer.</td> </tr> <tr> <td>253</td> <td><i>MAILB</i></td> <td>A request for mailbox-related records (resource record types <i>MB</i>, <i>MG</i> or <i>MR</i>; now obsolete.)</td> </tr> <tr> <td>254</td> <td><i>MAILA</i></td> <td>A request for mail agent resource records (now obsolete; <i>MX</i> records are used instead).</td> </tr> <tr> <td>255</td> <td>* (<i>asterisk</i>)</td> <td>A request for all records.</td> </tr> </tbody> </table>	QType Value	Question Type	Description	251	<i>IXFR</i>	A request for an incremental (partial) zone transfer , per RFC 1995.	252	<i>AXFR</i>	A request for a zone transfer .	253	<i>MAILB</i>	A request for mailbox-related records (resource record types <i>MB</i> , <i>MG</i> or <i>MR</i> ; now obsolete.)	254	<i>MAILA</i>	A request for mail agent resource records (now obsolete; <i>MX</i> records are used instead).	255	* (<i>asterisk</i>)	A request for all records.
QType Value	Question Type	Description																		
251	<i>IXFR</i>	A request for an incremental (partial) zone transfer , per RFC 1995.																		
252	<i>AXFR</i>	A request for a zone transfer .																		
253	<i>MAILB</i>	A request for mailbox-related records (resource record types <i>MB</i> , <i>MG</i> or <i>MR</i> ; now obsolete.)																		
254	<i>MAILA</i>	A request for mail agent resource records (now obsolete; <i>MX</i> records are used instead).																		
255	* (<i>asterisk</i>)	A request for all records.																		
QClass	2	<p>Question Class: Specifies the class of the resource record being requested, normally the value 1 for Internet (“IN”). See the topic on classes and resource record types for an explanation. In addition, the <i>QClass</i> value 255 is defined to have the special meaning “any class”.</p>																		

DNS Message Resource Record Field Formats

The exchange of information in DNS consists of a series of client/server transactions. Clients send requests, or *queries*, to servers, and the servers send back *responses*. DNS servers are of course [database servers](#), and store DNS name database information in the form of [resource records \(RRs\)](#). The questions asked by clients are requests for information from a DNS's servers database, and they are answered by the DNS server looking up the requested resource records and putting them into the DNS response message.

The *Answer*, *Authority* and *Additional* sections of the overall DNS message format are the places where servers put DNS resource records to be sent back to a client. Each section consists of zero or more records, and in theory, any record can be placed in any section. The sections only differ in the semantics (meaning) that the client draws from a record being in one section compared to the other. [The topic on DNS general messaging](#) contains more on these three sections and how they are used.

Resource records have two representations: binary and text. The text format is used for master files edited by humans, and is the subject of [a topic later in this section](#). The binary representation consists of regular numeric and text fields just like the other fields in the DNS message format.

DNS Common Resource Record Format

There are certain types of information that are common to all resource records, and others that are unique to each type of record. To handle this, all resource records are represented using a common field format, which contains a single *RData* field that varies by record type. The common resource record format is described in [Table 172](#) and [Figure 250](#).

Table 172: DNS Common Resource Record Format

Field Name	Size (bytes)	Description
Name	Variable	Name: Contains the object, domain or zone name that is the subject of the resource record, encoded using standard DNS name notation . All of the information in the resource record is associated with this object, which I call the <i>named object</i> for the record.
Type	2	Type: A code value specifying the type of resource record. The type values for the most common kinds of resource records are shown in Table 167 and also in the list of resource record details in this topic.
Class	2	Class: Specifies the class of the resource record being requested, normally the value 1 for Internet (“IN”). See the end of the topic on classes and resource record types for an explanation.
TTL	4	Time To Live: Specifies the number of seconds that the record should be retained in the cache of the device reading the record. See the topic on DNS name server caching for a full explanation. A value of zero means “use this information for the current name resolution only; do not cache it”.
RDLength	2	Resource Data Length: Indicates the size of the <i>RData</i> field, in bytes.
RData	Variable	Resource Data: The data portion of the resource record.

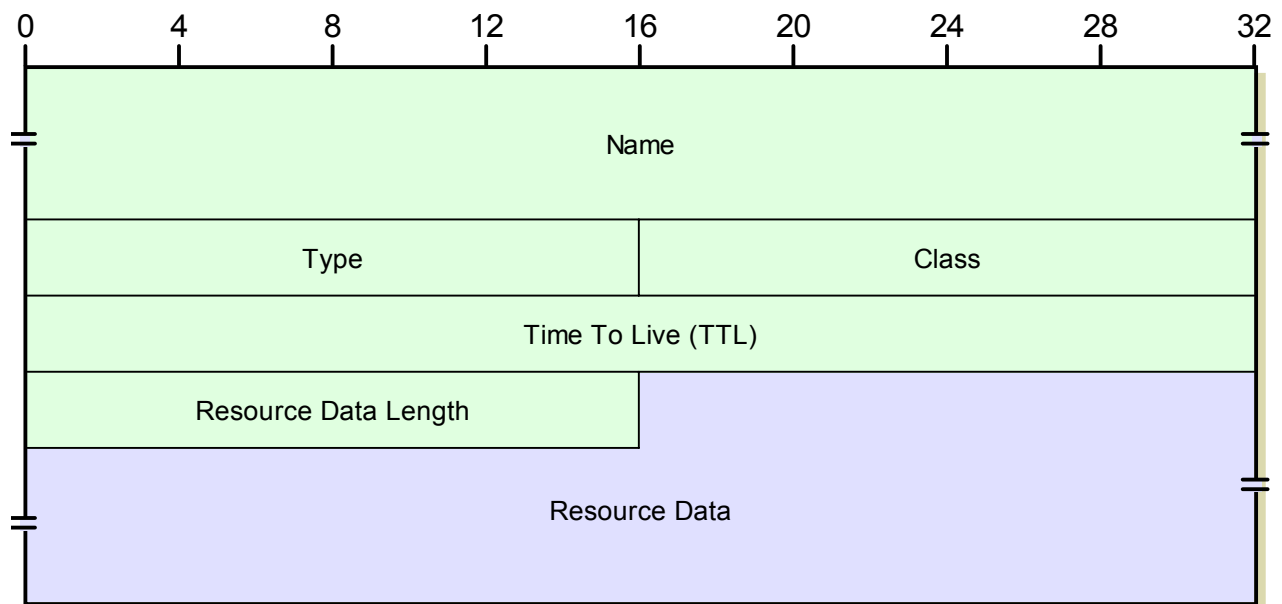

Figure 250: DNS Common Resource Record Format

RData Field Formats For Common Resource Records

The *RData* field consists of one or more subfields that carry the actual “payload” for the resource record. Below is a list of the most common resource record types. For each I have indicated the resource record text code, name, and *Type* value, provided a brief summary of the resource record’s use, and shown the structure of the *RData* field in a table:

A / Address Resource Record (Type Value 1)

This is the primary resource record type in DNS; it contains a 32-bit IP address associated with a domain name, as shown in [Table 173](#).

Table 173: DNS Address Resource Record Data Format

Subfield Name	Size (bytes)	Description
<i>Address</i>	4	Address: The 32-bit IP address corresponding to this record's named object.

NS / Name Server Resource Record (Type Value 2)

In this record, the data field carries the domain name of a name server ([Table 174](#)).

Table 174: DNS Name Server Resource Record Data Format

Subfield Name	Size (bytes)	Description
<i>NSDName</i>	Variable	Name Server Domain Name: A variable-length name of a name server that should be authoritative for this record's named object. Like all names, this name is encoded using standard DNS name notation . A request for this resource record type normally results in an <i>A</i> record for the name server specified also being returned in the <i>Additional</i> section of the response, if available.

CName / Canonical Name Resource Record (Type Value 5)

The data field contains the real name of an a named object that has been referenced using an alias ([Table 175](#)).

Table 175: DNS Canonical Name Resource Record Data Format

Subfield Name	Size (bytes)	Description
<i>CName</i>	Variable	Canonical Name: The canonical (real) name of the named object. This name is then resolved using the standard DNS resolution procedure to get the address for the originally-specified name.

SOA / Start Of Authority Resource Record (Type Value 6)

This record marks the start of [DNS zone](#) and contains key information about how it is to be managed and used. The SOA record is the most complex of the DNS resource record types; its format can be found in [Table 176](#) and also in [Figure 251](#).

Table 176: DNS Start Of Authority Resource Record Data Format

Subfield Name	Size (bytes)	Description
MName	Variable	Master Name: The domain name of the name server that is the source of the data for the zone; this is of course normally the primary authoritative server for the zone. It is encoded using the standard DNS name format .
RName	Variable	Responsible Name: The electronic mail address of the person responsible for this zone. E-mail addresses in DNS are encoded using a special variation of the regular DNS name notation .
Serial	4	Serial Number: The serial number, or version number, of the resource record database for this zone. Used to determine when changes have been made to the database to trigger zone transfers. See the topic on zone transfers for information on how this field is used .
Refresh	4	Refresh Interval: The number of seconds that secondary name servers for this zone will wait between attempts to check for changes made to the zone database on the primary name server. See the topic on zone transfers for information on how this field is used .
Retry	4	Retry Interval: The number of seconds a secondary name server waits before trying again to check with a primary for changes if its previous attempt failed. See the topic on zone transfers for details .
Expire	4	Expire Interval: The number of seconds that can elapse between successful contacts with the primary name server before a secondary name server must consider the information it holds “stale”.
Minimum	4	Negative Caching TTL: Originally carried the default <i>Time To Live</i> value for records where no explicit <i>TTL</i> value was specified. Now represents the zone’s negative cache TTL. See the topic on DNS name server caching .

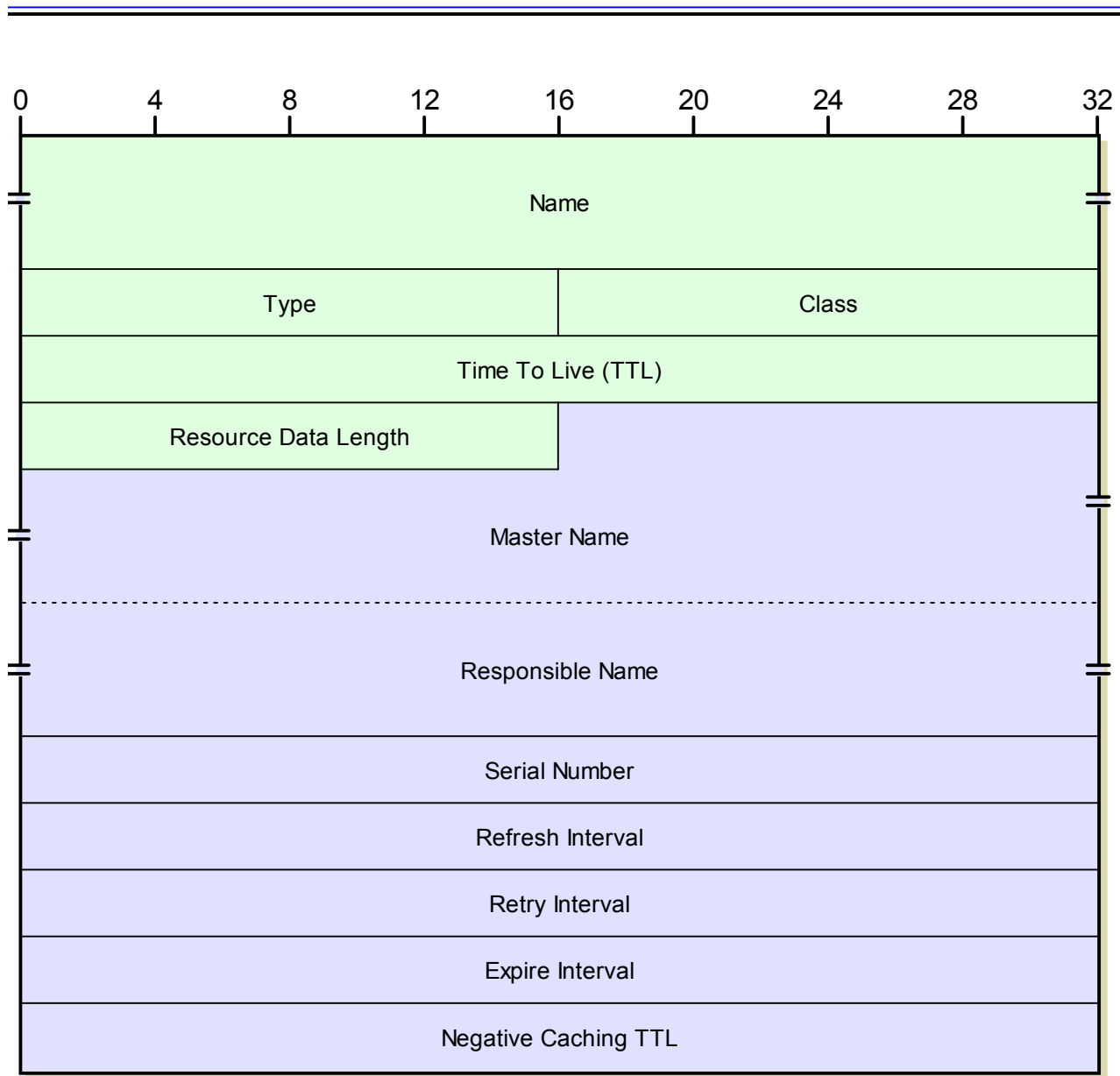

Figure 251: DNS Start Of Authority Resource Record Data Format

PTR / Pointer Resource Record (Type Value 12)

This record carries a pointer to a resource record; used for reverse address lookups. It contains one data field, shown in [Table 177](#).

Table 177: DNS Pointer Resource Record Data Format

Subfield Name	Size (bytes)	Description
<i>PTRDName</i>	Variable	<i>Pointer Domain Name:</i> A variable-length domain name. This is a name "pointed to" by the resource record; see the description of reverse resolution for the most common way that this record type is used.

MX / Mail Exchange Resource Record (Type Value 15)

This special record contains [information about the mail server\(s\) to be used for sending e-mail to the domain](#). Each record contains two fields as [Table 178](#) illustrates.

Table 178: DNS Mail Exchange Resource Record Data Format

Subfield Name	Size (bytes)	Description
<i>Preference</i>	2	Preference Value: The preference level for this mail exchange. Lower values signify higher preference.
<i>Exchange</i>	Variable	Exchange Domain Name: The domain name, encoded using standard DNS name notation , of a host willing to provide mail exchange services for this named object.

TXT / Text Resource Record (Type Value 16)

This descriptive record contains additional descriptive information about the named object ([Table 179](#)).

Table 179: DNS Text Resource Record Data Format

Subfield Name	Size (bytes)	Description
<i>TXT-Data</i>	Variable	Text Data: Variable-length descriptive text.

DNS Name Notation and Message Compression Technique

Obviously, the entire Domain Name System protocol is oriented around dealing with names for domains, subdomains and objects. We've seen in the preceding topics that there are many fields in DNS messages and resource records that carry the names of objects, name servers and so forth. DNS uses a special notation for encoding names in resource records and fields, a variation of this notation for e-mail addresses, and a special compression method that reduces the size of messages for efficiency.

Standard DNS Name Notation

In [the section describing the DNS name space](#) we saw how DNS names are constructed. Each node in the name hierarchy has a label associated with it. The [fully-qualified domain name \(FQDN\)](#) for a particular device consists of the sequence of labels that starts from the root of the tree and progresses down to that device. The labels at each level in the hierarchy are listed in sequence, starting with the highest level, from right to left, separated by dots. This results in the domain names we are used to working with, such as "www.xyzindustries.com".

It would be possible to encode these names into resource records or other DNS message fields directly: put the letter “w” into each of the first three bytes of the name, then put a “.” into the fourth byte, an “x” into the fifth and so on. The disadvantage of this is that as a computer was reading the name, it wouldn’t be able to tell when each name was finished. We would need to include a length field for each name.

Instead, DNS uses a special notation for DNS names. Each label is encoded one after the next in the name field. Before each label, a single byte is used that holds a binary number indicating the number of characters in the label. Then, the label’s characters are encoded, one per byte. The end of the name is indicated by a null label, representing the root; this of course has a length of zero, so each name ends with just a “0” character, indicating this zero-length root label.

Note that the “dots” between the labels aren’t necessary, since the length numbers delineate the labels. The computer reading the name also knows how many bytes are in each label as it reads the name, so it can easily allocate space for the label as it reads it from the name.

For example, “www.xyzindustries.com” would be encoded as:

“[3] w w w [13] x y z i n d u s t r i e s [3] c o m [0]”

I have shown the label lengths in square brackets to distinguish them. Remember that these label lengths are binary encoded numbers, so a single byte can hold a value from 0 to 255; that “[13]” is one byte and not two, as you can see in [Figure 252](#). Labels are actually limited to a maximum of 63 characters, and we’ll see shortly why this is significant.

0	4	8	12	16	20	24	28	32
	3	w	w	w				
	13	x	y	z				
	i	n	d	u				
	s	t	r	i				
	e	s	3	c				
	o	m	0					

Figure 252: DNS Standard Name Notation

In DNS every named object or other name is represented by a sequence of label lengths and then labels, with each label length taking one byte and each label taking one byte per character. This example shows the encoding of the name “www.xyzindustries.com”.

DNS Electronic Mail Address Notation

Electronic mail addresses are used in certain DNS resource records, such as the *RName* field in the *Start Of Authority* resource record. E-mail addresses of course take the form “<name>@<domain-name>”. DNS encodes these in exactly the same way as regular DNS domains, simply treating the “@” like another dot. So, “johnny@somewhere.org” would be treated as “johnny.somewhere.org” and encoded as:

“[6] j o h n n y [9] s o m e w h e r e [3] o r g [0]”.

Note that there is no specific indication that this is an e-mail address. The name is interpreted as an e-mail address instead of a device name based on context.

DNS Message Compression

A single DNS message may contain many domain names. Now, consider that when a particular name server sends a response containing multiple domain names, they are all usually in the same zone, or are related to the zone. Most of these names will have common elements to their names.

Consider our [previous mail example](#) of a client asking for an MX record for “xyzindustries.com”. The response to this client will contain, among other things, these two records:

- ☉ **MX Record:** An *MX* record that has “xyzindustries.com” as the *Name* of the record, and “mail.xyzindustries.com” in the *RData* field.
- ☉ **A Record:** Assuming the name server knows the IP address of “mail.xyzindustries.com”, the *Additional* section will contain an *A* record that has “mail.xyzindustries.com” as the *Name* and its address in the *RData field*.

This is just one small example of name duplication; it can be much more extreme with other types of DNS messages, with certain string patterns being repeated many times. Normally this would require that each name be spelled out fully using the encoding method described above. But this would be wasteful, since a large portion of these names is common.

Using Message Compression to Avoid Duplication of a Full Name

To cut down on duplication, a special technique called *message compression* is used. Instead of a DNS name encoded as above using the combination of labels and label-lengths, a two-byte subfield is used to represent a *pointer* to another location in the message where the name can be found. The first two bits of this subfield are set to one (the value “11” in binary), and the remaining 14 bits contain an *offset* that species where in the message the name can be found, counting the first byte of the message (the first byte of the *ID* field) as 0.

Let's go back to our example. Suppose that in the DNS message above, the *RData* field of the MX record, containing “mail.xyzindustries.com”, begins at byte 47. In this first instance, we would find the name encoded in full as:

“[4] m a i l [13] x y z i n d u s t r i e s [3] c o m [0]”.

However, the second instance, where “mail.xyzindustries.com” shows up in the *Name* field of the *A* record, we would instead put two “1” bits, followed by the number 47 encoded in binary. So, this would be the 16-bit binary pattern “11000000 00101111”, or two numeric byte values “192” and “47”. This second instance now takes 2 bytes instead of duplicating the 24 bytes needed for the first instance of the name.

How does a device reading a name field differentiate a pointer from a “real” name? This is the reason that “1” is used at the start of the field. Doing this guarantees that the first byte of the pointer will always have a value of 192 or larger. Since labels are restricted to a length of 63 or less, when the host reads the first byte of a name, if it sees a value of 63 or less in a byte, it knows this is a “real” name; a value of 192 or more means it is a pointer.

Using Message Compression to Avoid Duplication of Part of a Name

The example above shows how pointers can be used to eliminate duplication of a whole name: the name “mail.xyzindustries.com” was used in two places and a pointer was used instead of the second. Pointers are even more powerful than this, however. They can also be used to point to only *part* of a real name, or can be combined with additional labels to provide a compressed representation of a name related to another name in a resource record. This provides even greater space savings.

In the example above, this means that even the *first* instance of “mail.xyzindustries.com” can be compressed. Recall that the *MX* record will have “xyzindustries.com” in the *Name* field and “mail.xyzindustries.com” in the *RData* field. If the *Name* field of that record starts at byte 19, then we can encode the *RData* field as:

“[4] m a i l [pointer-to-byte-19]”.

The device reading the record will get “mail” for the first label and then read “xyzindustries.com” from the *Name* field to get the complete name, “mail.xyzindustries.com”.

Similarly, suppose we had a record in this same message that contained a reference to the parent domain for “xyzindustries.com”, which is of course “com”. This could simply be encoded as:

“[pointer-to-byte-33]”

The reason is that byte 33 is where we find the “[3] c o m [0]” part of the *Name* field containing “[13] x y z i n d u s t r i e s [3] c o m [0]”.

DNS Master File Format

DNS servers answer queries from clients by sending reply messages containing resource records. We have already seen in this section [the binary message formats used to encode these resource records](#). These message formats are great for transmitted messages, because they are compact and efficient, and computers have no problem reading fields very quickly and knowing how to interpret a particular string of ones and zeroes.

Humans, on the other hand, don't deal well with cryptic codes in binary. Before a resource record can be provided by a server, it is necessary for a human administrator to tell the server what those records are and what information they contain. To make this job easier, DNS includes a special text representation for zones and resource records. Administrators edit special *master files* that describe the zone and the records it contains; these files are then read into memory by the server's DNS software, and converted into binary form for responding to client requests. This is described in more detail in [the overview topic on resource records](#).

Each master file consists of a simple “flat text” file that can be created with any sort of text editor. Each file contains a number of lines expressed using a simple set of syntax rules that describe a zone and the records within it. The basic syntactic rules for DNS master files are specified in RFC 1035, section 5.1. Certain DNS implementations use their own variations on the syntax in the standard, though they are all pretty similar.

DNS Common Master File Record Format

Just as all resource records are stored internally using a common field format, they also use a common master file format. Each record normally appears on a separate line of the file. This format is as follows, with optional fields shown in square brackets:

```
<domain-name> [<ttd>] <class> <type> <rdata>
```

The fields are as follows:

- **<domain-name>**: A DNS domain name, which may be either a fully-qualified domain name (FQDN) or a partially-qualified name (PQDN). See below.
- **<ttd>**: A *Time To Live* value, in seconds, for the record. If omitted, the default *TTL* value for the zone is used. In fact, most resource records do not have a specified *TTL*, just using the default provided by the *Start Of Authority* record.
- **<class>**: The resource record class. For modern DNS this field is optional, and defaults to “IN” for “Internet”
- **<type>**: The resource record type, specified using a text code such as “A” or “NS”, not the numeric code.
- **<rdata>**: Resource record data, which is a set of space-separated entries that depends on the record type.

The “<rdata>” can be either a single piece of information or a set of entries, depending on the record type. In the case of longer record types, especially the *Start Of Authority* record, multiple entry “<rdata>” fields are spread over several lines and enclosed in parentheses; the parentheses make all the entries act as if they were on a single line. Note that if the “<ttd>” field is present, the order of it and the “<class>” field may be switched; this causes no problems because one is a number and the other text (“IN”).

Use and Interpretation of Partially-Qualified Domain Names

Domain names may be mixed between [FQDNs](#) and [PQDNs](#). Partially-qualified names are used to make master files faster to create and more readable, by cutting down on the common parts of names; they are sort of the “human equivalent” of DNS message compression. A FQDN is shown as a full domain name ending in a dot (“.”) to represent the DNS name tree root. A PQDN is given as just a partial name with no root, and is interpreted as a FQDN by the software reading the master file (see the *\$ORIGIN* directive below for more.)

It is important to remember the trailing dot to mark FQDNs; if the origin is “xyzindustries.com” and in its zone file the name “bigisp.net” appears, the server will read this as “bigisp.net.xyzindustries.com”—probably not what you want. Also, e-mail addresses, such as the <r-name> field in the SOA record, have the “@” of the e-mail address converted to a dot, following the standard DNS convention.

Master File Directives

In addition to resource records, most master file implementations also support the use of *directives*. These are commands that specify certain important pieces of information to guide how the master file is to be interpreted. Three of the most common directives are:

- ☉ **\$ORIGIN:** Specifies the domain name that is appended to unqualified specifications; this is the “base” used to convert PQDNs to FQDNs. For example, if the origin is “xyzindustries.com.”, then a PQDN such as “sales” will be interpreted as “sales.xyzindustries.com.”. Once defined, the origin can be referenced by just using “@” in place of a name, as we will see in the example at the end of this topic.
- ☉ **\$TTL:** Specifies the default *Time To Live* value to be used for any resource records that do not specify a *TTL* value in the record itself. (This value was formerly specified by the *Minimum* field in the *Start Of Authority* record.)
- ☉ **\$INCLUDE:** Allows one master file to include the contents of another. This is sometimes used to save the duplication of certain entries that are common between zones.

Syntax Rules for Master Files

There are a few other syntax rules for DNS master files, some of which are intended to save further time or energy on the part of administrators:

- ☉ **Multiple-Record Shorthand:** If multiple consecutive records pertain to the same domain, the “<domain-name>” is specified for the first one, and can be then be left blank for the subsequent ones. The server will assume that any resource records without a “<domain-name>” indicated apply to the last “<domain-name>” it saw.
- ☉ **Comments:** A semicolon (“;”) marks a comment. Any text from the semicolon until the end of the line is ignored.
- ☉ **Escape Character:** A backslash (“\”) is used to “escape” the special meaning of a character. For example, a double-quote (“”) is used to delimit text strings; a literal double-quote character is indicated by a backslash-double-quote combination (“\”).

- ☉ **White Space:** Tabs and spaces are used as delimiters and blank lines are ignored. For readability, most smart administrators indent using tabs to make more clear which records belong with which names, and group records using blank lines and comments.
- ☉ **Case:** Like DNS domain names, master file entries are case-insensitive.

Specific Resource Record Syntax and Examples

Table 180 shows the specific formats and examples for each of the common resource record types. The fields are basically the same as the ones explained in the DNS binary record formats. I have included explanatory “comments” using the DNS comment format. Assume that the examples in this table are for the zone “googleplex.edu”:

Table 180: DNS Master File Format Syntax and Examples

Resource Record Text Code	Resource Record Type	Resource Record Format / Example
A	<i>Address</i>	<pre><domain-name> [<t11>] IN A <ip-address> admin1.googleplex.edu IN A 204.13.100.3 ; A FQDN. admin2 IN A 204.13.100.44 ; A PQDN equivalent to ; admin2.googleplex.edu</pre>
NS	<i>Name Server</i>	<pre><domain-name> [<t11>] IN NS <name-server-name> googleplex.edu. IN NS custns.bigisp.net ; Secondary NS</pre>
CNAME	<i>Canonical Name</i>	<pre><domain-name> [<t11>] IN CNAME <canonical-name> www IN CNAME bigserver ; www.googleplex.edu is really ; bigserver.googleplex.edu.</pre>
SOA	<i>Start Of Authority</i>	<pre><domain-name> [<t11>] IN SOA <m-name> <r-name> (<serial-number> <refresh-interval> <retry-interval> <expire-interval> <default-ttl>) googleplex.edu. IN SOA ns1.googleplex.edu it.googleplex.edu (42 ; Version 42 of the zone. 21600 ; Refresh every 6 hours. 3600 ; Retry every hour. 604800 ; Expire after one week. 86400) ; Negative Cache TTL is one day.</pre>
PTR	<i>Pointer</i>	<pre><reverse-domain-name> [<t11>] IN PTR <domain-name> 3.100.13.204.IN-ADDR.ARPA. IN PTR admin1.googleplex.edu.</pre>
MX	<i>Mail Exchange</i>	<pre><domain-name> [<t11>] IN MX <preference-value> <exchange-name> googleplex.edu. IN MX 10 mainmail.googleplex.edu. IN MX 20 backupmail.googleplex.edu</pre>
TXT	<i>Text</i>	<pre><domain-name> [<t11>] IN TXT <text-information> googleplex.edu. IN TXT "Contact Joe at X321 for more info."</pre>

Note that the *PTR* record would actually be in the *IN-ADDR.ARPA* domain, of course.

Table 181 contains a “real-world” example of a DNS master file, taken from my own “pcguide.com” server (slightly modified), hosted by (and DNS information provided by) the fine folks at *pair.com*. Note the use of “@” as a short-cut to mean “this domain” (“pcguide.com”):

Table 181: Sample DNS Master File

```
$ORIGIN pcguide.com.
@ IN SOA ns23.pair.com. root.pair.com. (
    2001072300 ; Serial
    3600       ; Refresh
    300        ; Retry
    604800    ; Expire
    3600 )     ; Minimum

@ IN NS ns23.pair.com.
@ IN NS ns0.ns0.com.

localhost IN A      127.0.0.1
@         IN A      209.68.14.80
         IN MX 50   qs939.pair.com.

www       IN CNAME  @
ftp      IN CNAME  @
mail     IN CNAME  @
relay    IN CNAME  relay.pair.com.
```



DNS Changes To Support IP Version 6

Version 4 of the Internet Protocol (IPv4) is the basis of today's Internet, and the foundation upon which the TCP/IP protocol suite is built. While IPv4 has served us well for over two decades, it has certain important drawbacks that would limit internetworks of the future if it were to continue to be used. For this reason, the next generation of IP, the [Internet Protocol version 6 \(IPv6\)](#), has been in development for many years. IPv6 will eventually replace IPv4 and take TCP/IP into the future.

The change from IPv4 to IPv6 will have effects that “ripple” to other TCP/IP protocols, including the Domain Name System. DNS is a higher-level protocol, so you might think that based on the principle of layering, a change to IP should not affect it. However, this is another example of how “strict layering” doesn't always apply. DNS works directly with IP addresses, and one of the most significant modifications that IPv6 makes to IP is in the area of addressing, so this means that using DNS on IPv6 requires some changes to how the protocol works.

IPv6 DNS Extensions

Since DNS is so “architecturally distant” from IP down there at layer three, the changes required are not extensive. RFC 1886, entitled *IPv6 DNS Extensions* and published in December 1995, was the IETF's first formalized attempt to describe the changes needed in DNS to support IPv6. It defines three specific modifications to DNS for IPv6:

- ☉ **New Resource Record Type—AAAA (IPv6 Address):** The regular DNS *Address resource record* is defined for a 32-bit IPv4 address, so a new one was created to allow a domain name to be associated with a 128-bit IPv6 address. The four “A”s (“AAAA”) are a mnemonic to indicate that the IPv6 address is four times the size of the IPv4 address. The AAAA record is structured in very much the same way as the A record in both binary and master file formats; it is just much larger. The DNS resource record *Type* value for AAAA is 28.
- ☉ **New Reverse Resolution Hierarchy:** A new hierarchical structure similar to *IN-ADDR.ARPA* is defined for IPv6 [reverse lookups](#), but the IETF put it in a different top-level domain. The new domain is *IP6.INT*, and is used in a way similar to how *IN-ADDR.ARPA* works. However, since IPv6 addresses are expressed in hexadecimal instead of dotted-decimal, IP6.INT has sixteen subdomains “0” through “F”, and each of those has sixteen subdomains “0” through “F”, and so on, sixteen layers deep. Yes, this leads to a potentially frightfully large reverse resolution database!
- ☉ **Changes To Query Types And Resolution Procedure:** All query types that work with A records or result in A records being included in the *Additional* section of a reply must be changed to also handle AAAA records. Also, queries that would normally result in A records being returned in the *Additional* section must return the corresponding AAAA records only in the *Answer* section, not the *Additional* section.



Key Concept: Even though DNS resides far above the Internet Protocol in the TCP/IP protocol suite architecture, it works intimately with IP addresses. For this reason, changes are required to allow it to support the new IPv6. These changes include the definition of a new IPv6 address resource record (AAAA), a new reverse resolution domain hierarchy, and certain changes to how messaging is performed.

Proposed Changes to the IPv6 DNS Extensions

In 2000, the IETF published RFC 2874, *DNS Extensions to Support IPv6 Address Aggregation and Renumbering*. This standard proposed a replacement for the IPv6 support introduced in RFC 1886, using a new record type, *A6*, instead of 1886's *AAAA*. The main difference between *AAAA* and *A6* records is that the former are just whole addresses like *A* records, while *A6* records can contain either a whole or partial address.

The idea behind RFC 2874 was that *A6* records could be set up in a manner that complements [the IPv6 format for unicast addresses](#). Then, name resolution would involve a technique called *chaining* to determine a full address for a name from a set of partially-specified address components. In essence, this would make the addresses behave much the way hierarchical names themselves work, providing some potential flexibility benefits.

For a couple of years, both RFC 1886 and RFC 2874 were proposed standards, and this led to considerable confusion. In August 2002, RFCs 3363 and 3364 were published, which clarified the situation with these two proposals. RFC 3363 represents the “Supreme Court decision”, which was that RFC 2874 and the *A6* record be changed to experimental status and the *AAAA* record of RFC 1886 be kept as the DNS IPv6 standard.

The full explanation for the decision can be found in RFC 3364. In a nutshell, it boiled down to the IETF believing that there were significant potential risks in the successful implementation of RFC 2874. While the capabilities of the *A6* record were “interesting”, it was not clear that they were needed, and given those risks, they felt sticking with RFC 1886 was the better move.



Network File and Resource Sharing Protocols and the TCP/IP Network File System (NFS)

To the typical end user, networks were created for one main reason: to permit the sharing of information. Most information on computers exists in the form of files that reside on storage devices such as hard disks; thus, one primary purpose of networks is to let users share files. File transfer and message transfer protocols exist that allow users to “manually” move files from one place to the next, but a more automated method is preferable in many cases. Internetworking protocols provide such capabilities in the form of *network file and resource sharing protocols*.

In this section, I provide a description of network file and resource sharing protocols from the standpoint of TCP/IP networks. I begin with a brief overview of the concepts and operation of this class of protocols, discussing some of the elements common to the different types. I then describe the most common one defined specifically for TCP/IP: the Network File System (NFS).



Related Information: Obviously, network file and resource sharing protocols and services are closely related to the file and message transfer protocols I mentioned earlier. For example, NFS can be used to accomplish tasks similar to those performed by [TCP/IP file and message transfer applications](#) such as [FTP](#) and [HTTP](#). I consider those protocols more like specific end-user application unto themselves, and therefore describe them in [the section on application protocols](#). I realize that this distinction between “manual” and “automatic” file transfer is somewhat arbitrary, but then, so are a lot of other things in the great world of networking. ☺

Overview of File and Resource Sharing Protocol Concepts and Operation

Networking is a pretty complicated subject—if you don't believe me, try glancing at the topic list for this Guide. To people like you, who are probably reading this Guide to learn about networks to enhance your ability to make a living in the technology world, this complexity means enhanced job security, so don't knock it. ☺ On the other hand, the main body of “regular users” just want to be able to do things on the network, without being forced to understand how everything works underneath. This is only common sense.

Contrasting "Manual" and "Automatic" File and Resource Sharing

A primary reason why networks and internetworks are created is to allow files and other resources to be shared between computers. Thus, in any internetworking protocol stack, we need some mechanism by which users can easily moves files across a network in a simple way. Application-layer file and message transfer protocols like FTP and HTTP were created for just this purpose: to let users access resources across a network while hiding the details of how the network operates at the layers below them.

However, even though these protocols hide the lower layers, they are somewhat “manual” in nature: they require a user to invoke an application protocol and use specific commands that accomplish network-based resource access. In fact, the problem with such protocols isn't so much that they require manual intervention, but that they make sharing more difficult because they don't allow a file to be used directly on another resource. To see what I mean, consider a protocol like FTP. It does lets me share files between machines, but draws a clear distinction between a file that is mine and a file that is someone else's. If I want to use a file on Joe's machine, I have to transfer it to mine, use it, and then transfer it back. Also, if I don't transfer the file back, Joe might never even see the updated version.

The ultimate in file and resource sharing is achieved when we can hide even the details of how the files are located and the commands required to move them around. Such a system would use an “automatic” sharing protocol that lets files and resources be used over a network seamlessly. Once set up, a network resource in such a scheme can be used in much the same way that one on a local computer is. Such protocols are sometimes called *network file and resource sharing protocols*.

It is this “blurring” of the line between a local file and a remote one that makes file and resource sharing protocols so powerful. Once the system is set up, a user can access resources on another host as readily as on his own host. This is an extremely powerful capability, especially in the modern era of client/server computing. For example, it allows a company to store information that is used by many individuals in a common place, such as in a directory on a server, and allow each of those individuals to access it. In essence, a “virtual file system” is created that spans network devices, instead of being simply on one storage device on a single computer.

Components of a File and Resource Sharing Protocol

Network file and resource sharing protocols allow users to share files “effortlessly”, but that doesn't mean the work doesn't still have to happen. It is still there, but shouldered by those who write the protocol, and those who administer its operation. Generally speaking, these protocols require at least the following general components:

- ① **File System Model and Architecture:** A mechanism for defining resources and files to be shared, and for describing how the “virtual file system” works.
- ② **Resource Access Method:** Procedures that describe how a user can attach or detach a distant resource from his or her local host.
- ③ **Operation Set:** A set of operations for accomplishing various tasks that the user needs to perform on files on other hosts.
- ④ **Messaging Protocol:** Message formats that carry operations to be performed, status information and more, and a protocol for exchanging these messages between devices.
- ⑤ **Administrative Tools:** Miscellaneous functionality needed to support the operation of the protocol and tie the other elements together.

The most common file and resource sharing protocol used in TCP/IP today is the Network File System (NFS). It is described in more detail in the next section.



TCP/IP Network File System (NFS)

[File and resource sharing protocols](#) are important because they let users seamlessly share files over a network. Due to the dominance of Microsoft operating systems in the industry, many people are familiar with the way Microsoft Networking can be used in this way. However, Microsoft is somewhat of a “Johnny come lately” to file sharing protocols. Long before Microsoft Windows even existed, the *Network File System (NFS)* was letting users share files over a network using the UNIX operating system.

In this section, I provide a brief look at the operation of NFS. I begin with an overview and history of the protocol, and discussion of its common versions and standards. I describe the architecture of NFS and the three components that comprise it. I then describe the NFS file system model, and how data is encoded using the External Data Representation (XDR) standard. I explain the client/server operation of NFS using Remote Procedure Calls (RPCs). I then list the procedures and operations used in NFS, and conclude with a description of the separate NFS Mount protocol, used to attach network resources to a device.



Note: As I said above, NFS was originally developed specifically for the UNIX operating system, and is still most closely associated with UNIX. As with all protocol descriptions, I have attempted to keep my discussion of NFS “OS-independent” as much as possible, but in some places in this section, it is not entirely possible.

NFS Overview, History, Versions and Standards

The histories of TCP/IP and the Internet are inextricably linked, as you can read for yourself in my [discussion of the history of TCP/IP](#). However, there is a third partner that is less-often mentioned, but very much part of the development history of these technologies. That is the operating system that ran on the machines in the early Internet, still used on a large percentage of Internet servers today: the *UNIX* operating system.

Sun Microsystems was one of the early pioneers in the development of UNIX, and in TCP/IP networking. Early in the evolution of TCP/IP, certain tools were created to allow a user to access another machine over the network—after all, this is arguably the entire point of networking. Remote access protocols such as [Telnet](#) allowed a user to log in to another host computer and use resources there. The [File Transfer Protocol \(FTP\)](#) allowed someone to copy a file from a distant machine to their own and edit it.

However, neither of these solutions really fit the bill of allowing a user to access a file on a remote machine in a way similar to how a local file is used. To fill this need, Sun created the *Network File System (NFS)*. NFS was specifically designed with the goal of eliminating the distinction between a local and a remote file. To a user, after the appropriate setup is performed, a file on a remote computer can be used as if it were on a hard disk on the

user's local machine. Sun also crafted NFS specifically to be vendor-independent, to ensure that both hardware made by Sun and that made by other companies could interoperate.

Overview of NFS Architecture and General Operation

NFS follows the [classical TCP/IP client/server model of operation](#). A hard disk or a directory on a storage device of a particular computer can be set up by an administrator as a shared resource. This resource can then be accessed by client computers, which *mount* the shared drive or directory, causing it to appear like a local directory on the client machine. Some computers may act as only servers or only clients, while others may be both: sharing some of their own resources and accessing resources provided by others.

NFS uses an architecture that includes three main components that define its operation. The [External Data Representation \(XDR\) standard](#) defines how data is represented in exchanges between clients and servers. The [Remote Procedure Call \(RPC\) protocol](#) is used as a method of calling procedures on remote machines. Then, a set of [NFS procedures and operations](#) works using RPC to carry out various requests. The separate [Mount protocol](#) is used to mount resources as mentioned above.

One of the most important design goals of NFS was **performance**. Obviously, even if you set up a file on a distant machine as if it were local, the actual read and write operations have to travel across a network. Usually this takes more time than simply sending data within a computer, so the protocol itself needed to be as “lean and mean” as possible. This decision led to some interesting decisions, such as the use of the unreliable [User Datagram Protocol \(UDP\)](#) for transport in TCP/IP, instead of the reliable TCP like most file transfer protocols do. This in turn has interesting implications on how the protocol works as a whole.

Another key design goal for NFS was **simplicity** (which of course is related to performance). NFS servers are said to be *stateless*, which means that the protocol is designed so that servers do not need to keep track of which files have been opened by which clients. This allows requests to be made independently of each other, and allows a server to gracefully deal with events such as crashes without the need for complex recovery procedures. The protocol is also designed so that if requests are lost or duplicated, file corruption will not occur.



Key Concept: The *Network File System (NFS)* was created to allow client hosts to access files on remote servers as if they were local. It was designed primarily with the goals of performance, simplicity and cross-vendor compatibility.

NFS Versions and Standards

Since it was initially designed and marketed by Sun, NFS began as a [de facto standard](#). The first widespread version of NFS was version 2, and this is still the most common version of the protocol. NFS version 2 was eventually codified as an official TCP/IP standard when RFC 1094, [NFS: Network File System Protocol Specification](#), was published in 1989.

NFS Version 3 was subsequently developed, and published in 1995 as RFC 1813, [NFS Version 3 Protocol Specification](#). It is similar to version 2 but makes a few changes and adds some new capabilities. These include support for larger file transfers, better support for setting file attributes, and several new file access and manipulation procedures. NFS version 3 also provides support for larger files than version 2 did.

NFS Version 4 was published in 2000 as RFC 3010, [NFS version 4 Protocol](#). Where version 3 of NFS contained only relatively small changes to version 2, NFSv4 is virtually a rewrite of NFS. It includes numerous changes, most notably the following:

- ☉ Reflecting the needs of modern internetworking, NFSv4 puts greater emphasis on security.
- ☉ NFSv4 introduces the concept of a *Compound* procedure, which allows several simpler procedures to be sent from a client to server as a group.
- ☉ NFSv4 almost doubles the number of individual procedures that a client can use in accessing a file on an NFS server.
- ☉ Version 4 also makes a significant change in messaging, with the specification of [TCP](#) as the transport protocol for NFS.
- ☉ Finally, NFS integrates the functions of the Mount protocol into the basic NFS protocol, eliminating it as a separate protocol as it is in versions 2 and 3.

The version 4 standard also has a lot more details about implementation and optional features than the earlier standards—it's 275 pages long. So much for simplicity! ☺ RFC 3010 was later updated by RFC 3530, [Network File System \(NFS\) version 4 Protocol](#), in April 2003. This standard makes several further revisions and clarifications to the operation of NFS version 4.

NFS Architecture and Components

Considered from the perspective of the TCP/IP protocol suite as a whole, the Network File System (NFS) is a single protocol that resides at the application layer of the [TCP/IP \(DOD\) model](#). This TCP/IP layer encompasses the session, presentation and application layers of the [OSI Reference Model](#). As I have said before in this Guide, I don't see much value in trying to differentiate between layers 5 through 7 most of the time. In some cases, however, these layers can be helpful in understanding the architecture of a protocol, and that's the case with NFS.

NFS Architecture and Main Components

The operation of NFS is defined in the form of three main components that can be viewed as logically residing at each of the three OSI model layers corresponding to the TCP/IP application layer (see [Figure 253](#)). These components are:

- ☉ **Remote Procedure Call (RPC):** RPC is a generic [session layer](#) service used to implement client/server internetworking functionality. It extends the notion of a program calling a local procedure on a particular host computer, to the calling of a procedure on a remote device across a network.
- ☉ **External Data Representation (XDR):** XDR is a descriptive language that allows data types to be defined in a consistent manner. XDR conceptually resides at the [presentation layer](#); its universal representations allow data to be exchanged using NFS between computers that may use very different internal methods of storing data.
- ☉ **NFS Procedures and Operations:** The actual functionality of NFS is implemented in the form of procedures and operations that conceptually function at [layer seven](#) of the OSI model. These procedures specify particular tasks to be carried out on files over the network, using XDR to represent data and RPC to carry the commands across an internetwork.

These three key “subprotocols” if you will, comprise the bulk of the NFS protocol. Each is described in more detail in a separate topic of this section on NFS.



Key Concept: NFS resides architecturally at the application layer of the TCP/IP model. Its functions are implemented primarily through three distinct functional components that implement the functions of layers five through seven of the OSI reference model: the *Remote Procedure Call (RPC)*, which provide session-layer services; the *External Data Representation (XDR)* standard, which manages data representation and conversion, and *NFS procedures and operations*, which allow application-layer tasks to be performed using the other two components.

Other Important NFS Functions

Aside from these three components, the NFS protocol as a whole involves a number of other functions, some of which I think are worth specific mention:

- ☉ **Mount Protocol:** A specific decision was made by the creators of NFS to not have NFS deal with the particulars of file opening and closing. Instead, a separate protocol called the *Mount* protocol is used for this purpose. Accessing a file or other resource over the network involves first *mounting* it using this protocol. The Mount Protocol is architecturally distinct, but obviously closely related to NFS, and is even defined in an appendix of the NFS standard. [I describe it in the last topic of this section.](#) (Note that in NFSv4 the functions of the Mount Protocol have been incorporated into NFS “proper”.)
- ☉ **NFS File System Model:** NFS uses a particular model to implement the directory and file structure of the systems that use it. This model is closely based on the file system model of UNIX but is not specific to only that operating system. [It is discussed in conjunction with the explanation of the Mount Protocol.](#)

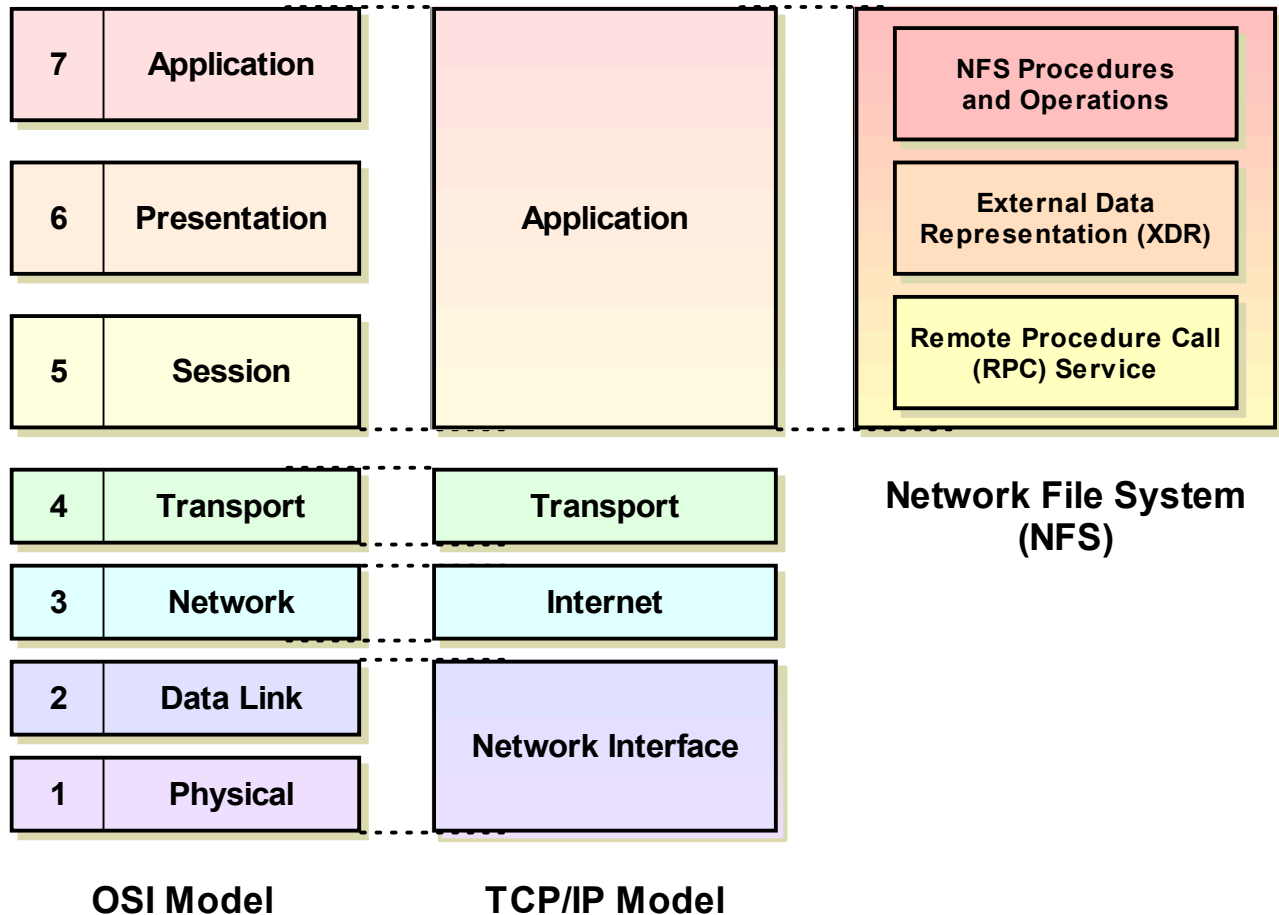

Figure 253: NFS Architectural Components

NFS resides architecturally at the TCP/IP application layer. Even though in the TCP/IP model no clear distinction is made generally between the functions of layers five through seven of the OSI Reference Model, NFS's three subprotocols correspond well to those three layers as shown.

- ☉ **Security:** Versions 2 and 3 of NFS include only limited security provisions. They use UNIX style authentication to check permissions for various operations. NFS version 4 greatly increases the security options available for NFS implementations. This includes both the option of multiple authentication and encryption algorithms, and many changes made to the protocol as a whole to make it more “security minded”.

Like other TCP/IP protocols, NFS is implemented in the form of client and server software that implements the functions above. The NFS standards, especially for versions 3 and 4, discuss numerous issues related to proper NFS client/server implementation, including interaction between servers and clients, file locking, permission issues, caching, retransmission policies, international support and more. Many of these issues require extensive discussion that is beyond the scope of this Guide. You will want to refer to the standards for NFS, especially versions 3 and 4, for full details.

NFS Data Storage and Data Types, and the External Data Representation (XDR) Standard

The overall idea behind NFS is to allow someone on one computer to read from or write to a file on another computer as readily as they do on a local machine. Of course, the files on your local machine are all stored in the same file system, using the same file structure and the same means of representing different types of data. You can't be sure that this will be the case when accessing a remote device, and this creates a bit of a "Tower of Babel" problem that NFS has to deal with.

Creating a Method of Universal Data Exchange: XDR

One approach to representation consistency would be to simply restrict access only to remote files on machines that use the same operating system. However, this would remove much of the effectiveness of NFS. It would also be highly impractical to require every computer to understand the internal representation of every other one. A more general method was needed to allow even very dissimilar machines to share data. To this end, the creators of NFS defined it so that it deals with data using a universal data description language. This language is called the *External Data Representation (XDR)* standard, and was originally described in RFC 1014; it was updated in RFC 1832, *XDR: External Data Representation Standard*, in 1995.

The idea behind XDR is simple, and can be easily understood in the form of an analogy. If you had delegates speaking 50 different languages at a convention, they would have a hard time communicating. You could hire translators to facilitate, but you'd never find translators to handle all the different possible combinations of languages. A more practical solution is to declare one language, such as English, to be a common language. You then only need 49 translators: one to translate from English to each of the non-English languages and back again. To translate from Swedish to Portuguese, you translate from Swedish to English and then from English to Portuguese. The common language could be French, or Spanish, or something else, as long as a translator could be found from all the other languages to that common language.

XDR works in the same manner. When information about how to access a file is to be transferred from device *A* to device *B*, device *A* first converts it from *A*'s internal representation to the XDR representation of those data types. The information is transmitted across the network using XDR encoding. Then, device *B* translates from XDR back to its own internal representation, so it can be presented to the user as if it were on the local file system. Each device needs to know only how to convert from its own "language" to XDR and back again; device *A* doesn't need to know device *B*'s internal details and vice-versa. This sort of translation is of course a classic job of the presentation layer, which is where XDR resides in the OSI Reference Model. XDR is itself based on an ISO standard called the *Abstract Syntax Notation*.

Incidentally, the idea described here is also used in other protocols to allow the exchange of data independent of the nature of the underlying systems. For example, a similar idea is behind [the way management information is exchanged using the Simple Network Management Protocol \(SNMP\)](#). The same basic idea underlies the important *Network Virtual Terminal (NVT)* paradigm used in the [Telnet protocol](#).



Key Concept: The purpose of the *External Data Representation (XDR)* standard is to define a common method for representing common data types. Using this universal representation, data can be exchanged between devices regardless of what internal file system each uses. This enables NFS to exchange file data between clients and servers that may be implemented using very different hardware and software platforms.

XDR Data Types

For XDR to be universal, it must allow the description of all the common types of data that are used in computers. For example, it must allow integers, floating point numbers, strings and other data constructs to be exchanged. The XDR standard describes the structure of many data types using a notation somewhat similar to the language “C”. As you may know, this is one of the most popular languages in computing history, and is closely associated with UNIX and, as a result, certain TCP/IP technologies as well.

[Table 182](#) shows the data types defined by XDR, which can be used by NFS in exchanging data between client and server. For each I have included the data type code, its size in bytes, and a name and a brief description.

Table 182: NFS External Data Representation (XDR) Data Types (Page 1 of 2)

Data Type Code	Size (bytes)	Description
int	4	Signed Integer: A 32-bit signed integer in two's complement notation, capable of holding a value from -2,147,483,648 to +2,147,483,647.
unsigned int	4	Unsigned Integer: A 32-bit unsigned integer, from 0 to 4,294,967,295.
enum	4	Enumeration: An alternate way of expressing a signed integer where some of the integer values are used to stand for particular constant values. For example, you could represent the colors of the rainbow, by defining the value 1 to stand for “PURPLE”, 2 to stand for “BLUE” and so on.
bool	4	Boolean: A logical representation of an integer, analogous to a two-level enumeration where a value of 0 is defined as “FALSE” and 1 is “TRUE”.
hyper	8	Signed Hyper Integer: Same as a regular signed integer, but 8 bytes wide to allow much larger numbers.
unsigned hyper	8	Unsigned Hyper Integer: Same as a regular unsigned integer but 8 bytes wide to allow much larger numbers.

Table 182: NFS External Data Representation (XDR) Data Types (Page 2 of 2)

Data Type Code	Size (bytes)	Description
float	4	Floating-Point Number: A 32-bit signed floating-point number. 1 bit holds the sign (positive or negative), 8 bits hold the exponent (power), in base 2, and 23 bits hold the mantissa (fractional part of the number).
double	8	Double-Precision Floating-Point Number: The same as <i>float</i> but with more bits to allow greater precision. 1 bit is for the sign, 11 bits for the exponent and 52 bits for the mantissa.
quadruple	16	Quadruple-Precision Floating-Point Number: The same as <i>float</i> and <i>double</i> but with still more bits to allow greater precision. 1 bit is for the sign, 15 bits for the exponent and 112 bits for the mantissa.
opaque	Variable	Opaque Data: Data that is to be passed between devices without being given a specific representation using XDR. The term <i>opaque</i> means that the data is treated like a “black box” whose insides cannot be seen. Obviously, any machines using this data type must themselves know how to deal with it, since NFS does not.
string	Variable	String: A variable-length string of ASCII characters.
(array)	Variable	Arrays: A group of any single type of the elements above, such as integers, floating point numbers and so on, may be specified in an array to allow many to be referenced as a single unit. They are not indicated using a separate data type code.
struct	Variable	Structure: An arbitrary structure containing other data elements from this table. This allows the definition of complex data types.
union	Variable	Discriminated Union: A complex form of structure that I cannot do justice to with a short description here. ☺
void	0	Void: A “null” data type that contains nothing.
const	0	Constant: Doesn't declare data, just defines a constant value used in other representations.

As you can see, XDR provides considerable data description capability. If you know the “C” language, much of what is in that table is probably familiar to you. Unfortunately, I can't really describe many of the more complex data types in the table above in detail without turning this into a guide to C programming.

In addition to the above, XDR also provides a means of defining new data types, and a method for specifying optional data. This provides even more flexibility beyond the large number of specific types already specifically described. Each version of NFS has a slightly different list of data types it supports.

NFS Client/Server Operation Using Remote Procedure Calls (RPCs)

Almost all applications deal with files and other resources. When a software program on a particular computer wants to read a file, write a file or perform related tasks, it needs to use the correct software instructions for this purpose. It would be inefficient to require each software program to contain a copy of these instructions, so instead, they are encoded as

standardized software modules, sometimes called *procedures*. To perform an action, a piece of software *calls* the procedure; the procedure temporarily takes over for the main program and performs a task such as reading or writing data. The procedure then returns control of the program back to the software that called it, and optionally, returns data as well.

Since the key concept of NFS was to make remote file access look like local file access, it was designed around the use of a network-based version of the procedure calling method just described. A software application that wants to do something with a file still makes a procedure call, but it makes the call to a procedure on a different computer instead of the local one. A special set of routines is used to handle the transmission of the call across the network, in a way largely invisible to software performing the call.

This functionality could have been implemented directly in NFS, but instead Sun created a separate session-layer protocol component called the *Remote Procedure Call (RPC)* specification, which defines how this works. RPC was originally created as a subcomponent of NFS, but is generic enough and useful enough that it has been used for other client/server applications in TCP/IP. For this reason, it is really considered in many respects a distinct protocol.

Because RPC is the actual process of communicating in NFS, NFS itself is different from many other TCP/IP protocols. Its operation can't be described in terms of specific message exchanges and state diagrams the way a protocol like HTTP or DHCP or even TCP can, because RPC does all of that. NFS is in fact defined in terms of a set of [RPC server procedures and operations](#) that an NFS server makes available to NFS clients. These procedures and operations each allow a particular type of action to be taken on a file, such as reading from it, writing to it or deleting it.

RPC Operation and Transport Protocol Usage

When a client wants to perform some type of action on a file on a particular machine, it uses RPC to make a call to the NFS server on that machine. The server accepts the request and performs the action required, then returns a result code and possibly data back to the client, depending on the request. The result code indicates if the action was successful. If it was, the client can assume that whatever it asked to be done was completed. For example, in the case of writing data, the client can assume the data has been successfully written to long-term storage.

NFS can operate over any transport mechanism that has a valid RPC implementation at the session layer. Of course in TCP/IP we have [two transport protocols, UDP and TCP](#). It's interesting to see that NFS has seen an evolution of sorts in its use of transport protocol. The NFSv2 standard says that it operates "normally" using UDP, and this is still a common way that NFS information is carried. NFSv3 says that either UDP or TCP may be used, but NFSv4 specifies TCP to carry data. The nominal registered port number for use by NFS is 2049, but in fact other port numbers are sometimes used for NFS, through the use of RPC's "port mapper" capability.



Key Concept: NFS does not use a dedicated message format, like most other protocols do. Instead, clients and servers use the *Remote Procedure Call (RPC)* protocol to exchange file operation requests and data.

Client and Server Responsibilities in NFS

Since UDP is unreliable, the use of that protocol to transport important information may seem strange. For example, we obviously don't want data that we are trying to write to a file to be lost in transit. Remember, however, that UDP doesn't preclude the use of measures to ensure reliable communications, it simply doesn't provide those capabilities itself. UDP can be used by NFS because the protocol itself is designed to tolerate loss of transmitted data and to recover from it.

Consistent with this concept, the general design of NFS puts most of the responsibility for implementing the protocol on the client, not the server. As the NFSv3 standard says, "NFS servers are dumb and NFS clients are smart." What this means is that the servers focus only on responding to requests, while clients must take care of most of the "nitty-gritty" details of the protocol, including recovery from failed communications. This is in fact a common requirement when UDP is used, because if a client request is lost in transit, the server has no way of knowing that it was ever sent.

As mentioned in [the NFS overview](#), NFS servers are designed to be "stateless". In simplified terms, this means that the NFS server does not keep track of the state of the clients using it from one request to another. Each request is independent of the previous one, and the server in essence has "no memory" of what it did before when it gets a new command from a client. This again requires more "smarts" to be put into the clients, but has the important advantage of simplifying recovery in the case that the server crashes. Since there is nothing that the server was keeping track of for the client, there's nothing that can be lost. This is an important part of ensuring that files are not damaged as a result of network problems or congestion.

Client and Server Caching

Both NFS clients and servers can make use of caching to improve performance. Servers may use caching to store recently-requested information in case it is needed again. They may also use *predictive* caching, sometimes called *prefetching*. In this technique, a server that receives a request to read a block of data from a file may load into memory the next block after it, on the theory that it will likely be requested next. Client-side caching is used to satisfy repeat NFS requests from applications while avoiding additional RPC calls. Like almost everything else about NFS, caching is implemented much more thoroughly in NFS version 4 than in the previous versions.



Key Concept: NFS is designed to be a *stateless* protocol, with intelligent clients and relatively “dumb” servers that respond to requests and do not maintain status information about what files are in use. NFS was originally designed to use UDP for transport, for efficiency purposes. This requires that NFS clients take care of detecting lost requests and retransmitting them. NFS version 4 uses TCP to take advantage of TCP’s reliability and other features.

NFS Server Procedures and Operations

The actual exchange of information between an NFS client and server is performed by the underlying [Remote Procedure Call \(RPC\) protocol](#). NFS functionality is therefore described not in terms of specific protocol operations, but by delineating the different actions that a client may take on files residing on a server. In the original version of NFS, NFSv2, these are called *NFS server procedures*.

Each procedure represents a particular action that a client may perform, such as reading from a file, writing to a file, or creating or removing a directory. The operations performed on the file require that the file be referenced using a data structure called a *file handle*. As the name suggests, the file handle, like the handle of a real object, lets the client and server “grasp” onto the file. The [Mount protocol](#) is used to mount a file system, to enable a file handle to be accessed for use by NFS procedures.

NFS version 3 uses the same basic model for server procedures, but makes certain changes. Two of the NFSv2 procedures were removed, and several new ones added to support new functionality. The numbers assigned to identify each procedure were also changed.

NFS Version 2 and Version 3 Server Procedures

[Table 183](#) shows the server procedures defined in versions 2 and 3 of NFS. The table shows the procedure numbers for both NFSv2 and NFSv3, as well as the name of each procedure and a description of what it does. I have kept the descriptions short so the table can serve as a useful summary of what NFS can do. They are listed in order of the procedure number used in NFSv2.

Table 183: NFS Version 2 and Version 3 Server Procedures (Page 1 of 3)

Procedure # (v2)	Procedure # (v3)	Procedure Name	Procedure Summary	Description
0	0	<i>null</i>	Do Nothing	Dummy procedure provided for testing purposes.
1	1	<i>getattr</i>	Get File Attributes	Retrieves the attributes of a file on a remote server.
2	2	<i>setattr</i>	Set File Attributes	Sets (changes) the attributes of a file on a remote server.

Table 183: NFS Version 2 and Version 3 Server Procedures (Page 2 of 3)

Procedure # (v2)	Procedure # (v3)	Procedure Name	Procedure Summary	Description
3	—	<i>root</i>	Get Filesystem Root (obsolete)	This procedure was originally defined to allow a client to find the root of a remote file system, but is now obsolete. This function is instead now implemented as part of the Mount protocol . It was removed in NFSv3.
4	3	<i>lookup</i>	Look Up File Name	Returns the file handle of a file for the client to use.
5	5	<i>readlink</i>	Read From Symbolic Link	Reads the name of a file specified using a symbolic link.
6	6	<i>read</i>	Read From File	Reads data from a file.
7	—	<i>writocache</i>	Write To Cache	Proposed for future use in version 2 but abandoned and removed from version 3.
8	7	<i>write</i>	Write To File	Writes data to a file.
9	8	<i>create</i>	Create File	Creates a file on the server.
10	12	<i>remove</i>	Remove File	Deletes a file from the server.
11	14	<i>rename</i>	Rename File	Changes the name of a file.
12	15	<i>link</i>	Create Link To File	Creates a "hard" (non-symbolic) link to a file.
13	10	<i>symlink</i>	Create Symbolic Link	Creates a symbolic link to a file.
14	9	<i>mkdir</i>	Create Directory	Creates a directory on the server.
15	13	<i>rmdir</i>	Remove Directory	Deletes a directory.
16	16	<i>readdir</i>	Read From Directory	Reads the contents of a directory.
17	—	<i>statfs</i>	Get File System Attributes	Provides to the client general information about the remote file system, including the size of the file system and the amount of free space remaining. In NFSv3 this was replaced by <i>fsstat</i> and <i>fsinfo</i> .
—	4	<i>access</i>	Check Access Permission	(New in NFSv3.) Determines the access rights that a user has for a particular file system object.
—	11	<i>mknod</i>	Create A Special Device	(New in NFSv3.) Creates a special file such as a named pipe or device file.
—	17	<i>readdirplus</i>	Extended Read From Directory	(New in NFSv3.) Retrieves additional information from a directory.

Table 183: NFS Version 2 and Version 3 Server Procedures (Page 3 of 3)

Procedure # (v2)	Procedure # (v3)	Procedure Name	Procedure Summary	Description
—	18	<i>fsstat</i>	Get Dynamic File System Information	(New in NFSv3.) Returns volatile (dynamic) file system status information such as the current amount of file system free space and the number of free file slots.
—	19	<i>fsinfo</i>	Get Static File System Information	(New in NFSv3.) Returns static information about the file system, such as general data about how the file system is used, and parameters for how requests to the server should be structured.
—	20	<i>pathconf</i>	Retrieve POSIX Information	(New in NFSv3.) Retrieves additional information for a file or directory.
—	21	<i>commit</i>	Commit Cached Data On A Server To Stable Storage	(New in NFSv3.) Flushes any data that the server is holding in a write cache to storage. This is used to ensure that any data that the client has sent to the server but that the server has held pending write to storage is in fact written out.

NFS Version 4 Server Procedures and Operations

It is common that a client may want to perform multiple actions on a file: several consecutive reads, for example. One of the problems with the server procedure system in NFSv2 and NFSv3 is that each client action required a separate procedure call. This was somewhat inefficient, especially when NFS was used over a high-latency link.

To improve the efficiency of server procedures, NFS version 4 makes a significant change to the way that server procedures are implemented. Instead of each client action being a separate procedure, a single procedure called *compound* is defined. Within this “compound” procedure, a large number of *server operations* are encapsulated. These are all sent as a single unit and the server interprets and follows the instructions in each operation in sequence.

This change means there are actually only two RPC procedures in NFSv4, as shown in [Table 184](#).

Table 184: NFS Version 4 Server Procedures

Procedure #	Procedure Name	Procedure Summary	Description
0	<i>null</i>	Do Nothing	Dummy procedure provided for testing purposes.
1	<i>compound</i>	Compound Operations	Combines a number of NFS operations into a single request, as described above.

All the real client actions are defined as operations within the *compound* procedure, as shown in [Table 185](#). You'll notice that the number of NFSv4 operations is much larger than the number of procedures in NFSv2 and NFSv3. This is due both to the added features in version 4 and the fact that NFSv4 incorporates functions formerly performed by the separate Mount protocol into NFS itself.

Table 185: NFS Version 4 Server Operations (Page 1 of 2)

Operation #	Operation Name	Operation Summary	Description
3	<i>access</i>	Check Access Rights	Determines the access rights a user has for an object.
4	<i>close</i>	Close File	Closes a file.
5	<i>commit</i>	Commit Cached Data	Flushes any data that the server is holding in a write cache to storage, to ensure that any pending data is permanently recorded.
6	<i>create</i>	Create A Non-Regular File Object	This is similar to the <i>mknod</i> procedure in NFSv3; it creates a "non-regular" (special) object file. (Regular files are created using the <i>open</i> operation.)
7	<i>delepurge</i>	Purge Delegations Awaiting Recovery	NFSv4 has a feature where a server may delegate to a client responsibility for certain files. This operation removes delegations awaiting recovery from a client.
8	<i>delegreturn</i>	Return Delegation	Returns a delegation from a client to the server that granted it.
9	<i>getattr</i>	Get Attributes	Obtains the attributes for a file.
10	<i>getfh</i>	Get Current Filehandle	Returns a <i>file handle</i> , which is a logical object used to allow access to a file.
11	<i>link</i>	Create Link To A File	Creates a "hard" (non-symbolic) link to a file.
12	<i>lock</i>	Create Lock	Creates a lock on a file. Locks are used to manage access to a file, for example, to prevent two clients from trying to write to a file simultaneously and thus corrupting it.
13	<i>lockt</i>	Test For Lock	Tests for the existence of a lock on an object and returns information about it.
14	<i>locku</i>	Unlock File	Removes a lock previously created on a file.
15	<i>lookup</i>	Lookup Filename	Looks up or finds a file.
16	<i>lookupp</i>	Lookup Parent Directory	Returns the filehandle of an object's parent directory.
17	<i>nverify</i>	Verify Difference In Attributes	Checks to see if attributes have changed on a file.
18	<i>open</i>	Open A Regular File	Opens a file.
19	<i>openattr</i>	Open Named Attribute Directory	Opens an attribute directory associated with a file.

Table 185: NFS Version 4 Server Operations (Page 2 of 2)

Operation #	Operation Name	Operation Summary	Description
20	<i>open_confirm</i>	Confirm Open	Confirms information related to an opened file.
21	<i>open_downgrade</i>	Reduce Open File Access	Adjusts the access rights for a file that is already open.
22	<i>putfh</i>	Set Current Filehandle	Replaces one filehandle with another.
23	<i>putpubfh</i>	Set Public Filehandle	Sets the current filehandle to be the “public” filehandle of the server. This may or may not be the same as the root filehandle (see below).
24	<i>putrootfh</i>	Set Root Filehandle	Sets the current filehandle to be the root of the server's file system.
25	<i>read</i>	Read From File	Reads data from a file.
26	<i>readdir</i>	Read Directory	Reads the contents of a directory.
27	<i>readlink</i>	Read Symbolic Link	Reads the name of a file specified using a symbolic link.
28	<i>remove</i>	Remove Filesystem Object	Removes (deletes) an object.
29	<i>rename</i>	Rename Directory Entry	Changes the name of an object.
30	<i>renew</i>	Renew A Lease	Renews an NFS delegation made by a server. (Note that these leases have nothing to do with DHCP leases!)
31	<i>restorefh</i>	Restore Saved Filehandle	Allows a filehandle previously saved to be made the current filehandle.
32	<i>savefh</i>	Save Current Filehandle	Allows a filehandle to be saved so it can later be restored when needed.
33	<i>secinfo</i>	Obtain Available Security	Retrieves NFS security information.
34	<i>setattr</i>	Set Attributes	Changes one or more attributes of a file.
35	<i>setclientid</i>	Negotiate Clientid	Allows a client to communicate information to the server regarding how the client wants to use NFS.
36	<i>setclientid_confirm</i>	Confirm Clientid	Used to confirm the results of a previous negotiation using setclientid.
37	<i>verify</i>	Verify Same Attributes	Allows a client to verify certain attributes before proceeding with a particular action.
38	<i>write</i>	Write To File	Writes data to a file.
39	<i>release_lockowner</i>	Release Lockowner State	Used by a client to tell a server to release certain information related to file locks.
10044	<i>illegal</i>	Illegal Operation	A “placeholder” (dummy) operation used to support error reporting when an invalid operation is used in a request from a client.



Key Concept: File operations in NFS are carried out using NFS *server procedures*. In versions 2 and 3 of NFS, each procedure performs one action, such as reading data from a file. In version 4, a special *compound* action is defined that allows many individual *operations* to be sent in a single request to a server.

NFS File System Model and the Mount Protocol

Since NFS is used by a client to simulate access to remote directories of files as if they were local, the protocol must “present” the files from the remote system to the local user. Just as files on a local storage device are arranged using a particular file system, NFS too uses a *file system model* to represent how files are shown to a user.

The NFS File System Model

The file system model used by NFS is the same one that most of us are familiar with: a hierarchical arrangement of directories that contain files and subdirectories. The top of the hierarchy is the *root*, which contains any number of files and first level directories. Each directory may contain more files or other directories, allowing an arbitrary tree structure to be created.

A file can be uniquely specified by using its *file name* and a *path name* that shows the sequence of directories one must traverse from the root to find the file. Since NFS is associated with UNIX, files in NFS discussions are usually shown in UNIX notation; for example, “/etc/hosts”. The same basic tree idea can also be expressed using the method followed by Microsoft operating systems: “C:\WINDOWS\HOSTS”.

The Mount Protocol

Before NFS can be used to allow a client to access a file on a remote server, the client must be given a way of accessing the file. This means that a portion of the remote file system must be made available to the client, and the file opened for access. A specific decision was made when NFS was created to **not** put file access, opening and closing functions into NFS proper. Instead, a separate protocol was created to work with NFS, so that if in the future the method of providing file access needed to be changed, it wouldn't require changes to NFS itself. This separate mechanism is called the *Mount Protocol*, and is described in Appendix A of RFC 1094 (NFSv2). Note that while functionally distinct, Mount is considered part of the overall NFS package.

When NFS was revised to version 3, the Mount Protocol was similarly modified. The NFSv3 version of the Mount Protocol is defined in Appendix I of RFC 1813 (NFSv3). It contains some changes to how the protocol works, but the overall operation of the two versions of Mount is pretty much the same.

The term “mount” is actually an analog to a hardware term that refers to making a physical storage volume available. In the “olden days” storage devices were usually removable disk packs, and to use one you mounted it onto a drive unit. In a similar manner, NFS resources are logically mounted using the Mount protocol, which makes the shared file system available to the client. A file can then be opened and a file handle returned to the NFS client so it can reference the file for operations such as reading and writing.



Key Concept: Versions 2 and 3 of NFS do not include procedures for opening or closing resources on a remote server. Before NFS tasks can be accomplished on these versions, the special *Mount* protocol must be employed to mount a filesystem and create a file handle to access a file on it; the protocol is also used to unmount the file system when no longer required. The Mount protocol is implemented in a manner very similar to NFS itself, defining procedures that use RPC and XDR. In version 4 of NFS, Mount is no longer needed; the tasks it performs are implemented as NFSv4 operations.

Mount Protocol Server Procedures

The actual implementation of the Mount protocol is very similar to that of NFS itself. Like NFS, the Mount protocol uses XDR to define data types to be exchanged between client and server, and RPC to define a set of server procedures that clients may use to perform different operations. The main difference between Mount and NFS is simply that Mount defines procedures related to opening and closing filesystems rather than file access operations. Table 186 shows the server procedures used in the Mount protocol.

Table 186: NFS Mount Protocol Server Procedures

Procedure #	Procedure Name	Procedure Summary	Description
0	<i>null</i>	Do Nothing	Dummy procedure provided for testing purposes.
1	<i>mnt</i>	Add Mount Entry	Performs a mount operation by mapping a path on a server to a file handle for the client to use.
2	<i>dump</i>	Return Mount Entries	Returns a list of remotely mounted file systems.
3	<i>umnt</i>	Remove Mount Entry	Performs an “unmount” by removing a mount entry. (It should be “dismount”. Techies are rarely into grammar. ☺)
4	<i>umntall</i>	Remove All Mount Entries	Removes all mount entries, thus eliminating all mounted file systems between server and client.
5	<i>export</i>	Return Export List	Returns a list of exported file systems and indicates which clients are allowed to mount them. This is used to let the client see what served file systems are available for use.

As mentioned in other topics in this section, NFS version 4 does away with the notion of a separate Mount protocol, incorporating file mounting operations into NFS directly.



TCP/IP Network Configuration and Management **Protocols (BOOTP, DHCP, SNMP and RMON)**

Some folks study the [OSI Reference Model](#) just to pass a test and otherwise consider it “useless”. I think it's important because it shows how the different hardware and software components of an internetwork fit together. One aspect of this is that the model lets us see clearly how the functions of networks are implemented by building the higher-layer ones upon those at lower layers. We start at the bottom layers dealing primarily with hardware, and build upon them the software and protocols that make networks and internetworks in the middle layers. The highest layers of the OSI model, especially the application layer, run on top of the internetwork implemented by the layers below. It is therefore at this level that we normally talk about the protocols and applications that permit end users to perform different network communication tasks.

Of course, the users are why we create networks and internetworks in the first place. But while the application layer is indeed where we find user-oriented protocols, users are not the only ones who need to make use of network applications at this level. Network administrators have a number of functions that they must perform on a daily basis to keep networks running smoothly and efficiently, and many of these use support protocols at higher layers.

Decades ago, an administrator was probably responsible for only a small number of computers, all in the same building or even the same room. When something in the network needed to be fixed or changed, the techie would walk over to it and “administer” it. Today, a company's computers are probably not close at hand; they are likely spread out across a campus, a country or the entire world. It is no longer feasible to travel to each computer to perform various maintenance tasks. And with larger networks, trying to manually maintain thousands of computers, even if they were in the same building, would not be possible.

To make administration practical on modern networks, special application-level protocols were created that allow administrators to work with distance devices in a more automated manner over the internetwork itself. It may seem ironic to be using the internetwork to help administer the internetwork, but many tasks such as device configuration and management can be performed effectively using software protocols. Using these protocols yields significant advantages over manual processes, and is part of what keeps the internetworks we rely on running smoothly.

This section takes a look at two classes of administrative tasks that are served by application-layer protocols. The first subsection deals with host configuration, describing the concepts behind the process, and two protocols used for accomplishing automated configuration of internetwork hosts. The second describes protocols used to remotely manage, monitor and control remote hardware devices on an internetwork.

As part of this discussion, I describe in detail four TCP/IP protocols that implement host configuration and management functions. These are the TCP/IP Boot Protocol (BOOTP) and Dynamic Host Configuration Protocol (DHCP) for host configuration, and the Simple Network Management Protocol (SNMP) and Remote Network Monitoring Protocol (RMON) for network management.

Host Configuration and TCP/IP Host Configuration Protocols (BOOTP and DHCP)

Each host that is placed on a network or internetwork must be set up and configured before it can be used. Configuration ensures that the host functions properly, and that it is told the parameters needed for it to successfully communicate with other hosts and devices. In the “good old days”, administrators would manually set up each host as it was added to the network, and would also manually make changes to the configuration as they were required. Modern networks, however, are very large, and manual configuration of hosts is a time-consuming chore. Furthermore, we often need to make use of features that only automated configuration can provide, particularly for special hosts that have no internal storage. It is for these reasons that *host configuration* protocols were developed.

In this section I describe the concepts behind host configuration protocols, and then illustrate the operation of two of the most important ones in use today. I begin with a topic that provides an overview of host configuration concepts and issues. I describe the TCP/IP Bootstrap Protocol (BOOTP), the first truly capable automated configuration tool for IP hosts. I then describe BOOTP's successor, the feature-filled Dynamic Host Configuration Protocol (DHCP), which is used extensively in modern TCP/IP hardware and software.



Related Information: Technically, the very first host configuration protocol for TCP/IP was the [Reverse Address Resolution Protocol \(RARP\)](#). RARP is a very simple, crude protocol that allows very basic host configuration to be performed, but little else. RARP is very different from BOOTP and DHCP, not only because of its more limited capabilities, but because it operates between layers two and three like the [Address Resolution Protocol \(ARP\)](#) upon which it is based. It is therefore covered in [the same section](#) that describes ARP.

Host Configuration Concepts, Issues and Motivation

Putting a host on an internetwork requires that certain setup and configuration procedures be followed. Hardware must be selected and set up, and software too must be chosen and installed on the hardware. Once the software is set up, we aren't finished, however: we must also perform other configuration tasks that tell the software how we want it to operate, and give it certain parameters so it knows its role on the network and how to function.

The Purposes of Host Configuration

Probably the most important configuration task that must be performed for each host on an internetwork is to give it an *identity*, in the form of an address that is unique to it alone. In TCP/IP networks, each device must be given an IP address. Hosts also often require other parameters to ensure that they operate properly. For a TCP/IP network, we might want to tell each host some of the following:

- The address of a default router on the local network.
- The network mask the host should use.
- The addresses of servers providing particular services to the host, such as a [mail server](#) or a [DNS](#) name server.
- The [maximum transmission unit \(MTU\)](#) of the local network.
- What [Time To Live \(TTL\)](#) value to use for IP datagrams.

And possibly, a lot more; there are dozens of different parameters that must be set up for certain networks. Many of these may be common to all the machines on a network, but IP addresses must be unique. The administrator must therefore ensure that each is assigned to only one computer, even as machines are added to and removed from the network.

The Inefficiency of Manual Host Configuration

If you're an administrator in charge of a small ten-host LAN, performing setup and configuration is simple: for each host, you set up the hardware, install the software, and then configure the software. Even changes and keeping track of IP addresses wouldn't be a big deal; a single sheet of paper would suffice. However, what happens when your network has not ten computers but a hundred? How about a thousand? Ten thousand?

As the size of the network grows, the work needed for manual configuration grows with it. And while initial hardware setup may be time-consuming, at least it is done mainly when the host is first set up, and rarely changed thereafter. This is not the case with configuration parameters. If the address of the local router changes on a network with a thousand hosts, do you really want to go to each host to edit a configuration file? I sure don't!

Cases Where Manual Configuration Is Not Feasible

The drudge work associated with manual configuration is significant, but the problems with manual configuration go well beyond the inefficiency issue. There are situations where manual configuration is not just inconvenient, it's actually ***impossible***:

-
- 🕒 **Remote Configuration:** An administrator cannot be everywhere; modern networks can span cities or nations. Unless we want to train every user on how to configure network hosts, we must use an automated protocol.
 - 🕒 **Mobile Device Configuration:** IP was designed when computers were large and attached to each other using heavy cables; today we have computers that fit in a shirt pocket and communicate using radio waves. IP addresses must be assigned based on the network to which they are attached, and this makes reconfiguration required when a device is moved. This is not conducive to manual configuration at all.
 - 🕒 **“Dumb” Host Configuration:** Most of the hosts we use today are full-fledged computers, with their own internal storage. We can assign such a device an address by entering it into a file that the device reads when it starts up. There are certain devices, however, that do not include any form of storage. Since they are mass-produced, they are all identical and cannot have individualized parameters stored within them. Such a device relies on a configuration protocol to learn what it needs to function on a network—especially including its individual identity, as we saw above.
 - 🕒 **Address Sharing:** The proliferation of devices attached to the global Internet has led to a situation where IP addresses must be carefully managed to ensure that they are not wasted on devices that aren't using them. Some organizations even find themselves with more potential hosts than they have addresses. A host configuration protocol can allow an address to be automatically assigned to a host when needed, and then returned to a common “pool” for reuse when the host leaves the network. This permits addresses to be shared and reduces the need for more address space.

Automating the Process: Host Configuration Protocols

Even though most of us don't have robots that can automate the hardware portions of the setup and configuration job, we **can** employ tools that will make the rest of the job easier. This includes the use of special *host configuration* protocols. These protocols allow hosts to be automatically configured when they are set up, and to have additional parameters assigned when needed.

Host configuration protocols generally function by having a host send a request for an address and other parameters, which is satisfied by a response from a server. The information in the response is used by the client to set its address, identify a local router, and perform other necessary setup so it can communicate.

The use of an automated protocol solves all of the problem situations mentioned above. We can configure devices remotely, rather than having to walk to each one. We can instantly assign a valid address to mobile devices. We can have “dumb” hosts boot up and obtain the information they need to operate. Finally, we can maintain a pool of addresses that is shared by a group of hosts.



Key Concept: *Host configuration protocols* enable administrators to set up hosts so that they can automatically determine their address and other key parameters. They are useful not only because of the effort they save over manual configuration, but because they enable the automatic setup of remote, storageless or mobile devices.

The Role of Host Configuration Protocols in TCP/IP

You might find it strange that host configuration protocols would exist up here in the “lofty heights” of the application layer. It certainly sounds like host configuration is a function related more to the network layer, where internetwork addresses such as IP addresses function.

In fact, some host configuration protocols, like the rudimentary [Reverse Address Resolution Protocol \(RARP\)](#), do exist down at that level. However, there are advantages to having host configuration protocols reside at higher levels. A major one is that the operation of the protocol is not dependent on the hardware upon which the protocol runs, making it more universal. Another is being able to convey host configuration messages between networks, which is not possible with a low-level protocol operating on the local network.

This leads to another fair question: how can a device send and receive messages if it doesn't know its own address? As we'll see, the answer to this is the local [broadcast capabilities of networks](#). By broadcasting messages, it is possible for a device with no assigned IP address to receive configuration information: including an IP address. We'll see in the next section, discussing the Bootstrap Protocol (BOOTP), how this is done.



TCP/IP Bootstrap Protocol (BOOTP)

Before a device on a TCP/IP network can effectively communicate, it needs to know its IP address. While a conventional network host can read this information from its internal disk, some devices have no storage, and so do not have this luxury. They need help from another device on the network to provide them with an IP address and other information and/or software they need to become active IP hosts. This problem of getting a new machine up and running is commonly called *bootstrapping*, and to provide this capability to IP hosts, the TCP/IP *Bootstrap Protocol (BOOTP)* was created.

In this section I provide a fairly detailed look at the TCP/IP Bootstrap Protocol. I begin with an overview and history of the protocol and a look at the standards that define it. I then discuss the general client/server nature of BOOTP and how addressing is done in communication between the client and the server. I describe the operation of BOOTP step by step, and illustrate the format of BOOTP messages. I conclude with a description of BOOTP vendor extensions, which are used to allow the information sent in BOOTP messages to be customized, and a discussion of BOOTP relay agents, which allow the protocol to operate even when the BOOTP server and client are on different networks.



Related Information: BOOTP was the predecessor of the [Dynamic Host Configuration Protocol](#). DHCP was built to be substantially compatible with BOOTP and so the two protocols have a fair degree of commonality. To avoid duplication, certain information has been included only in the DHCP section, with links provided from the BOOTP topics where appropriate. On the other hand, some of the historical background information behind features like vendor information extensions and relay agents, which were first developed for BOOTP and adopted by DHCP, is in this section and linked from the DHCP topics. Why structure the sections this way? DHCP is far more popular than BOOTP today, so I wanted its description to be complete, but some features only really make sense if initially explained in the context of BOOTP's operation.

If you plan to read about DHCP as well as BOOTP, I recommend reading this section first. If you don't plan to read up on DHCP, you may wish to check the topic in [the DHCP topic on DHCP/BOOTP interoperability](#).

BOOTP Overview, History and Standards

The [TCP/IP protocol suite](#) has been with us for over two decades, and the problem of how to automate the configuration of parameters on IP hosts has been around almost as long. Back in the early 1980s, networks were small and relatively simple. Automated host configuration wasn't considered an important capability so much because of the difficulty of manual configuration. It was needed because there is no other way to configure devices like diskless workstations.

As I discussed in [the overview topic on host configuration](#), without a form of internal storage, a device must rely on someone or something to tell it “who it is” (its address) and how to function each time it is powered up. When a device like this is turned on, it is in a difficult position: it needs to use IP to communicate with another device that will tell it how to communicate using IP! This process, called *bootstrapping* or *booting*, comes from an analogy to a person “pulling himself up using his own bootstraps”. You've likely encountered this term before, if at no other time then at least when some tech support person has told you to “reboot” your computer.

BOOTP: Correcting the Weaknesses of RARP

The [Reverse Address Resolution Protocol \(RARP\)](#) was the first attempt to resolve this “bootstrap problem”. Created in 1984, RARP is a direct adaptation of the low-level [Address Resolution Protocol \(ARP\)](#) that binds IP addresses to link-layer hardware addresses. RARP is capable of providing a diskless device with its IP address, using a simple client/server exchange of a request and reply between a host and an RARP server.

The difficulty with RARP is that it has so many limitations. It operates at a fairly low level using hardware broadcasts, so it requires adjustments for different hardware types. An RARP server is also required on every physical network to respond to layer-two broadcasts. Each RARP server must have address assignments manually provided by an administrator. And perhaps worst of all, RARP only provides an IP address to a host and none of the other information a host may need. (I describe these issues in detail in [the topic on RARP](#).)

RARP clearly wasn't sufficient for the host configuration needs of TCP/IP. To support both the needs of diskless hosts and other situations where the benefits of autoconfiguration were required, the *Bootstrap Protocol (BOOTP)* was created. BOOTP was standardized in RFC 951, published September 1985. This relatively straight-forward protocol was designed specifically to address the shortcomings of RARP:

- ☉ It is still based on a client/server exchange, but is implemented as a higher-layer software protocol, using [UDP](#) for message transport. It is not dependent on the particular hardware of the network like RARP.
- ☉ It supports sending additional configuration information to a client beyond just an IP address. This extra information can usually all be sent in one message for efficiency.
- ☉ It can handle having the client and server on different networks of an internetwork. This allows the administration of the server providing IP addresses to be more centralized, saving money as well as administrative time and hassle.

BOOTP Deals With the First Phase of Bootstrapping

It should be noted that even though the name of BOOTP implies that it defines everything needed for a storageless device to “boot”, this isn't really the case. As the BOOTP standard itself describes, “bootstrapping” generally requires two phases. In the first, the client is provided with an address and other parameters. In the second, the client downloads software, such as an operating system and drivers, that let it function on the network and

perform whatever tasks it is charged with. BOOTP really only deals with the first of these phases: address assignment and configuration. The second is assumed to take place using a simple file transfer protocol like the [Trivial File Transfer Protocol \(TFTP\)](#).



Key Concept: The first widely-used host configuration protocol for TCP/IP was the *Boot Protocol (BOOTP)*. It was created specifically to enable host configuration while addressing many of the weaknesses of RARP. BOOTP is intended to be used as the first phase of a two-phase boot procedure for storageless devices—after obtaining an IP address and other configuration parameters using BOOTP, the device employs a protocol such as TFTP to download software necessary to function on the network.

Vendor-Specific Parameters

One smart decision made when BOOTP was created was the inclusion of a *vendor-specific area*. This was intended to provide a place where hardware vendors could define parameters relevant to their own products. As the complexity of TCP/IP increased, it was realized that this field could be used to define a method of communicating certain parameters that were commonly needed by IP hosts, and were in fact vendor-independent. This was first proposed in RFC 1048, *BOOTP Vendor Information Extensions*, published February 1988.

The fact that BOOTP can be used to provide information to a client beyond just an IP address makes it useful even in cases where a device already knows its address. BOOTP can be used to send parameters that the administrator wants all hosts to have, to ensure that they use the network in a consistent manner. Also, in the case of devices that do have local storage (and therefore do not need BOOTP to get an IP address), BOOTP can still be used to let these devices get the name of a boot file for the “phase two” of bootstrapping described above.

Changes to BOOTP and the Development of DHCP

BOOTP was the TCP/IP host configuration of choice from the mid-1980s through the end of the 1990s. The vendor extensions introduced in RFC 1048 were popular, and over the years, additional vendor extensions were defined; RFC 1048 was replaced by RFCs 1084, 1395 and 1497 in succession. Some confusion also resulted over the years in how some sections of RFC 951 should be interpreted, and how certain features of BOOTP work.

RFC 1542, *Clarifications and Extensions for the Bootstrap Protocol*, was published in October 1993 to address this, and also made some slight changes to the protocol's operation. (RFC 1542 is actually a correction of the nearly-identical RFC 1532 that had some small errors in it.)

While BOOTP was obviously quite successful, it also had certain weaknesses of its own. One of the most important of these is lack of support for *dynamic* address assignment. The need for dynamic assignment became much more pronounced when the Internet really started to take off in the late 90s. This led directly to the development of the [Dynamic Host Configuration Protocol \(DHCP\)](#).

While DHCP replaced BOOTP as the TCP/IP host configuration protocol of choice, it would be inaccurate to say that BOOTP is “gone”. It is still used to this day in various networks. Furthermore, DHCP was based directly on BOOTP, and they share many attributes, including a common message format. BOOTP vendor extensions were used as the basis for DHCP *options*, which work in the same way but include extra capabilities. In fact, the successor to RFC 1497 is RFC 1533, which officially merges BOOTP vendor extensions and BOOTP options into the same standard.

BOOTP Client/Server Messaging and Addressing

While BOOTP can be used for a variety of devices, one of the prime motives behind its creation was to provide a way to automatically configure “dumb” devices that have no storage. Most of these devices are relatively limited in their capabilities, and so requiring them to support a fancy boot protocol would not make sense. BOOTP is thus an uncomplicated protocol, which accomplishes host configuration without a lot of fancy concepts or implementation requirements.

BOOTP Clients and Servers

Like so many other TCP/IP protocols, BOOTP is [client/server in nature](#). The operation of the protocol consists of a single exchange of messages between a *BOOTP client* and a *BOOTP server*. A BOOTP client can be any type of device that needs to be configured. A BOOTP server is a network device that has been specially set up to respond to BOOTP client requests, and has been programmed with addressing and other information it can provide to clients when required.

The BOOTP server maintains a special set of information about the clients it serves. One key part of this is a table that maps the hardware (layer two, data link layer) addresses of each client to an assigned IP address for that device. The client specifies its hardware address in its request, and the server uses that address to look up the client's IP address and return it to the client. (Other techniques can also be used, but a mapping table is most common.)

Messaging and Transport

BOOTP messaging uses the [User Datagram Protocol \(UDP\)](#) as its layer four transport protocol, for a couple of reasons. First, UDP is a lot less complex than the other layer-four transport protocol ([TCP](#)) and is ideal for simple “request/reply” protocols like BOOTP. Second, since the client obviously doesn't know the address of a BOOTP server, the request is broadcast on its local network; UDP supports broadcasts while TCP does not.

UDP uses a special [well-known \(reserved\) port number](#) for BOOTP servers: UDP port 67. BOOTP servers “listen” on port 67 for these broadcast BOOTP requests sent by clients. After processing the request, the server sends a reply back to the client. How this is handled depends on whether the client knows its own address or not:

-
- ☉ **Client Knows Its Address:** There are some cases where the BOOTP client already knows its own address. In this case, the address can be used by the BOOTP server to send back its reply directly.
 - ☉ **Client Does Not Know Its Own Address:** BOOTP is of course often used to provide an IP address to a client that doesn't know its address. This is sometimes called a “chicken and egg” problem, because it represents a “loop” of sorts like the old conundrum of “which came first, the chicken or the egg”. To resolve this dilemma, the BOOTP server has two choices. If the operating system supports it, the server can use the client's hardware address to create an [ARP](#) entry for the device, and then use a layer-two unicast to deliver the reply. Otherwise, it must send the reply as a broadcast as well on the local network.

Use of Broadcasts and Ports

The fact that BOOTP servers may need to broadcast back to the client necessitates a bit of a change from the way most TCP/IP protocols use client ports. Recall that normally, the client in a client/server transaction using UDP or TCP generates a [temporary, or ephemeral port number](#) that it uses as the source port in its request. The server sends the reply back to the client's IP address using that ephemeral port number. Ephemeral port numbers must be unique for a particular IP address, but may not necessarily be unique across all the devices on a network. For example, device *A* may be using ephemeral port number 1,248 for an HTTP request to a Web server, while device *B* may be using port number 1,248 on its TCP/IP stack to send a DNS request.

Since the server in BOOTP is broadcasting, it is not targeting a particular device with a unicast transmission. This means it cannot safely send to an ephemeral port number: some other device on the network may have selected the same ephemeral port number for some other transaction and may mistake the BOOTP server's response as being intended for itself. To avoid this problem, another well-known port number is used just for BOOTP clients: UDP port 68. Clients listen on this port for broadcast or unicast transmissions, while of course devices that have not sent a BOOTP request will ignore it. This “dual broadcast” BOOTP communication process is illustrated in [Figure 254](#).



Key Concept: A BOOTP client use broadcasts to send its requests to any listening BOOTP server. In most cases, the BOOTP client device does not know its own IP address when it uses the protocol. For this reason, a BOOTP server will also typically use broadcast in sending its reply, to be sure it reaches the client.

Retransmission of Lost Messages

The drawback of the simplicity of using UDP for BOOTP messaging is that we get no transport quality features. UDP is unreliable, which means a BOOTP request might be lost before it gets to the server, or the server's response may similarly not get back to the client. Like many other protocols using UDP, BOOTP clients take care of this by using a retransmission timer. If after a certain period of time the client has not received a response, it re-sends its request.

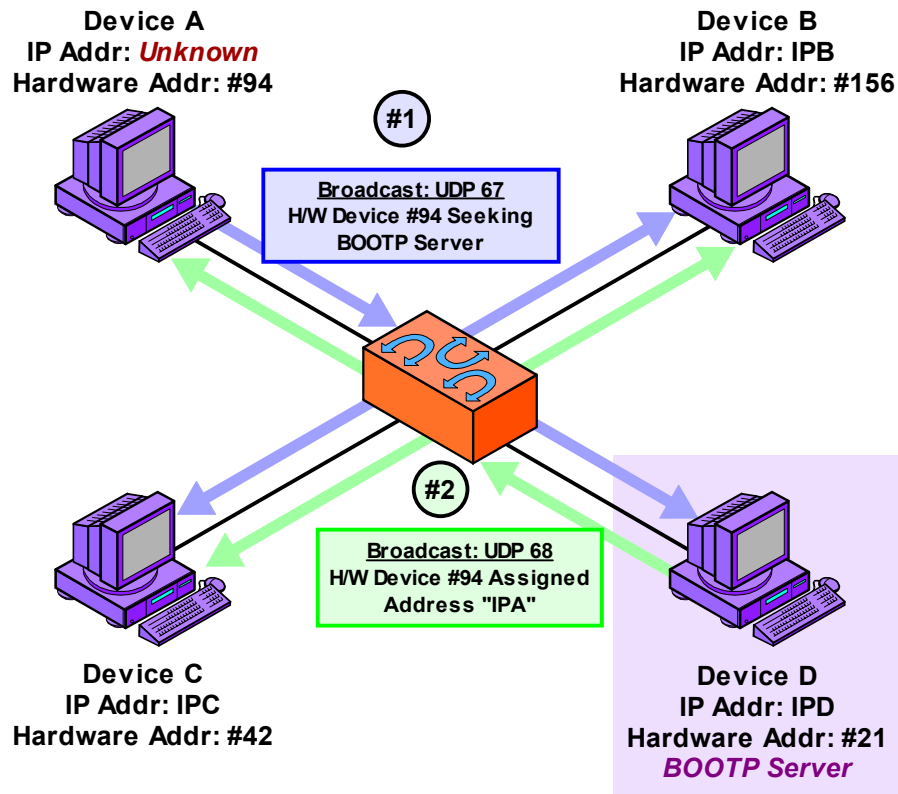

Figure 254: General Operation Of the Boot Protocol

BOOTP is a relatively simple client/server protocol that relies on broadcasts to permit communication with devices that do not have an assigned IP address. In this example Device A is trying to determine its IP address and other parameters. It broadcasts a BOOTP request on the local network using UDP port 67 and then listens for a reply on port 68. Device D is configured as a BOOTP server and listens on this port. When it receives the request it sends a broadcast on port 68 telling A what its IP address is.

However, BOOTP clients must take care in how they implement their retransmission strategy. Consider a scenario where a network with 200 BOOTP clients loses power. These machines are all pretty much the same, so when the power comes back on they all restart, and all try to send BOOTP requests at about the same time. Most likely, problems will occur due to all these requests; some will be lost, or the server may have to drop some due to overload.

If all the clients use the same amount of time for retransmission, then after that time elapses, a whole bunch of machines will again send requests and recreate the original problem. To avoid this, the BOOTP standard recommends using an exponential backoff scheme for retransmissions, starting with a retransmission interval of 4 seconds and doubling it for successive tries. A randomness element is also added to prevent many devices from overlapping their retransmissions. The idea is very similar to the backoff method used by Ethernet (in fact, the standard even refers to the Ethernet specification).

For example, the first retransmission would occur after a random period of time between 0 and 4 seconds (plus or minus a random amount); a second retransmission, if needed, after a random time interval between 0 and 8 seconds, plus or minus, and so forth. This helps reduce the chances of retransmissions being lost, and also helps ensure BOOTP traffic doesn't bog down the network.



Key Concept: BOOTP uses UDP for transport, which provide no reliability features. For this reason, the BOOTP client must detect when its requests are lost and if necessary, retransmit them.

BOOTP Detailed Operation

Now that we have seen [how BOOTP messaging works in general terms](#), let's take a closer look at the detailed operation of the protocol. This will let us more clearly see how clients and servers create and process messages, and also help make sense of some of the important fields in the BOOTP message field format. Understanding the basic operation of BOOTP will also be of use when we examine [BOOTP relay agents](#), and even when we discuss [DHCP](#).

BOOTP Bootstrapping Steps

The following are the basic steps performed by the client and server in a regular BOOTP bootstrapping procedure (see [Figure 255](#)).

1. Client Creates Request

The client machine begins the procedure by creating a BOOTP request message. In creating this message, it fills in the following information:

- ☉ It sets the message type (*Op*) to the value 1, for a *BOOTREQUEST* message.
- ☉ If it knows its own IP address that it plans to keep using, it specifies it in the *CIAddr* field. Otherwise, it fills this field with zeroes. (See below for more on this.)
- ☉ It puts its own layer-two hardware address in the *CHAddr* field. This is used by the server to determine the right address and other parameters for the client.
- ☉ It generates a random transaction identifier, and puts this in the *XID* field.
- ☉ The client may specify a particular server that it wants to send it a reply and put that into the *SName* field. It may also specify the name of a particular type of boot file that it wants the server to provide in the *File* field.
- ☉ The client may specify vendor-specific information, if programmed to do so.

2. Client Sends Request

The client broadcasts the *BOOTREQUEST* message by transmitting it to address 255.255.255.255. Alternately, if it already knows the address of a BOOTP server, it may send the request unicast.

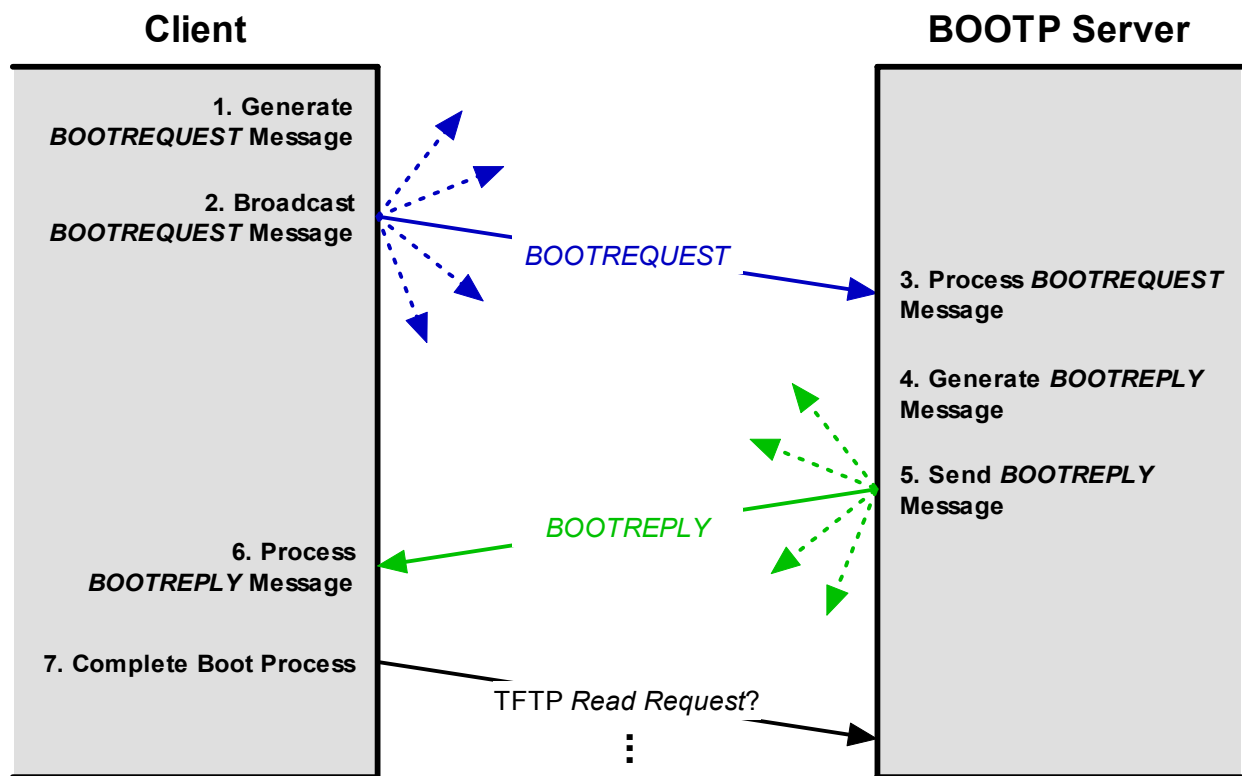

Figure 255: Boot Protocol Operation

The Boot Protocol uses a simple two-step message exchange consisting of a broadcast request and broadcast reply. After the client receives configuration information from the BOOTP server, it completes the bootstrapping process using a protocol such as TFTP.

3. Server Receives Request and Processes It

A BOOTP server, listening on UDP port 67, receives the broadcasted request and processes it. If a name of a particular server was specified and this name is different than the name of this server, the server may discard the request. This is especially true if the server knows that the server the client asked for is also on the local network. If no particular server is specified, or this particular server was the one the client wanted, the server will reply.

4. Server Creates Reply

The server creates a reply message by copying the request message and changing several fields:

- ☉ It changes the message type (*Op*) to the value 2, for a *BOOTREPLY* message.
- ☉ It takes the client's specified hardware address from the *CHAddr* field, and uses it in a table lookup to find the matching IP address for this host. It then places this value into the *YIAddr* ("your IP address") of the reply.

-
- ☉ It processes the *File* field and provides the filename type the client requested, or if the field was blank, the default filename.
 - ☉ It puts its own IP address and name in the *SIAddr* and *SName* fields.
 - ☉ It sets any vendor-specific values in the *Vend* field.

5. Server Sends Reply

The server sends the reply, the method depending on the contents of the request:

- ☉ If the *B* (*Broadcast*) flag is set, this indicates that the client can't have the reply sent unicast, so the server will broadcast it.
- ☉ If the *CIAddr* field is non-zero, the server will send the reply unicast back to that *CIAddr*.
- ☉ If the *B* flag is zero and the *CIAddr* field is also zero, the server may either use an ARP entry or broadcast, as described in [the previous topic](#).

6. Client Processes Reply

The client receives the server's reply and processes it, storing the information and parameters provided. (See below for one important issue related to this processing.)

7. Client Completes Boot Process

Once configured, the client proceeds to “phase two” of the bootstrapping process, by using a protocol such as TFTP to download its boot file containing operating system software, using the filename the server provided.

Interpretation of the Client IP Address (CIAddr) Field

A complication can arise when a client chooses to specify an IP address in the *CIAddr* field in its request. The problem is how exactly to interpret this field. Does it mean that the client is already using this IP address? Or is it just the one it used last time it was booted? Then there is the related problem of what to do if the server supplies an address in the *YIAddr* that is different from the one the client is using. Should the server's provided address override the client's address? Or should the client ignore it? Who makes the decision, the server or the client?

Much confusion occurred due to the vagueness of the original standard in this regard, and this led to non-uniformity in how different implementations chose to handle this issue. There were even some implementations that used the *CIAddr* to mean “the client requests this IP address”, which was never part of BOOTP functionality. This is an especially bad idea since it could lead directly to BOOTP replies never reaching the client.

RFC 1542 was written in part to try to clean up this mess. It suggests that the following is the best way to handle the meaning of these fields:

- ☉ If a client is willing to accept whatever IP address the server provides, it sets *CIAddr* to all zeroes, even if it knows a previous address.

- ☉ If the client fills in a value for the field, it is saying it will use this address, and must be prepared to receive unicast messages sent to that address.
- ☉ If the client specifies an address in *CIAddr* and receives a different address in the *YIAddr* field, the server-provided address is ignored.

Note that not all hardware devices may necessarily agree with this interpretation as provided by RFC 1542, so there are still potential interoperability issues here with older equipment. RFC 1542 was written in 1993, so this is probably not much of an issue any more.

BOOTP Message Format

The exchange of information in BOOTP takes the form of a request sent by a client, and a reply sent back by the server. BOOTP, like a number of other request/reply protocols, uses a common message format for requests and replies. The client starts by setting aside memory space for the message and clearing it to all zeroes. It then fills in the fields of the message and sends the request, as we saw in [the previous topic](#). The server creates its reply not from scratch, but by copying the request and changing certain fields.

BOOTP messages contain a considerable number of fields, so the message format is rather large. It is described fully in [Table 187](#) and illustrated in [Figure 256](#).

Table 187: BOOTP Message Format (Page 1 of 3)

Field Name	Size (bytes)	Description																				
Op	1	Operation Code: Specifies the type of message. A value of 1 indicates a request (<i>BOOTREQUEST</i> message) while a value of 2 is a reply (<i>BOOTREPLY</i> message).																				
HType	1	<p>Hardware Type: This field specifies the type of hardware used for the local network, and is used in exactly the same way as the equivalent field (<i>HRD</i>) in the Address Resolution Protocol (ARP) message format. Some of the most common values for this field:</p> <table border="1"> <thead> <tr> <th>HType Field Value</th> <th>Hardware Type</th> </tr> </thead> <tbody> <tr> <td>1</td> <td>Ethernet (10 Mb)</td> </tr> <tr> <td>6</td> <td>IEEE 802 Networks</td> </tr> <tr> <td>7</td> <td>ARCNET</td> </tr> <tr> <td>15</td> <td>Frame Relay</td> </tr> <tr> <td>16</td> <td>Asynchronous Transfer Mode (ATM)</td> </tr> <tr> <td>17</td> <td>HDLC</td> </tr> <tr> <td>18</td> <td>Fibre Channel</td> </tr> <tr> <td>19</td> <td>Asynchronous Transfer Mode (ATM)</td> </tr> <tr> <td>20</td> <td>Serial Line</td> </tr> </tbody> </table>	HType Field Value	Hardware Type	1	Ethernet (10 Mb)	6	IEEE 802 Networks	7	ARCNET	15	Frame Relay	16	Asynchronous Transfer Mode (ATM)	17	HDLC	18	Fibre Channel	19	Asynchronous Transfer Mode (ATM)	20	Serial Line
HType Field Value	Hardware Type																					
1	Ethernet (10 Mb)																					
6	IEEE 802 Networks																					
7	ARCNET																					
15	Frame Relay																					
16	Asynchronous Transfer Mode (ATM)																					
17	HDLC																					
18	Fibre Channel																					
19	Asynchronous Transfer Mode (ATM)																					
20	Serial Line																					

Table 187: BOOTP Message Format (Page 2 of 3)

Field Name	Size (bytes)	Description									
HLen	1	Hardware Address Length: Specifies how long hardware addresses are in this message. For Ethernet or other networks using IEEE 802 MAC addresses, the value is 6. This too is the same as the field with a similar name (<i>HLEN</i>) in the ARP field format .									
Hops	1	Hops: Set to 0 by a client before transmitting a request and used by BOOTP relay agents to control the forwarding of BOOTP messages.									
XID	4	Transaction Identifier: A 32-bit identification field generated by the client, to allow it to match up the request with replies received from BOOTP servers.									
Secs	2	Seconds: According to RFC 951, the client enters into this field the number of seconds “elapsed since [the] client started trying to boot”. This is supposed to provide information to BOOTP servers to help them decide which requests to respond to first. Unfortunately, this definition was somewhat vague; it wasn't clear if this meant the amount of time since the machine was powered on, or since the first <i>BOOTREQUEST</i> message was sent. In addition, some devices incorrectly implemented this field. As a result, it is not always used.									
Flags	2	Flags: In the original BOOTP standard (RFC 951), this was an empty two-byte field. RFC 1542 changed this to a <i>Flags</i> field, which at present contains only one flag. The structure of the field is thus as follows: <table border="1" data-bbox="591 1073 1451 1430"> <thead> <tr> <th>Subfield Name</th> <th>Size (bytes)</th> <th>Description</th> </tr> </thead> <tbody> <tr> <td>B</td> <td>1/8 (1 bit)</td> <td>Broadcast Flag: A client that doesn't know its own IP address at the time it sends its BOOTP request sets this flag to 1. This serves as an immediate indicator to the BOOTP server or relay agent that receives the request that it definitely should send its reply by broadcast.</td> </tr> <tr> <td>Reserved</td> <td>1 7/8 (15 bits)</td> <td>Reserved: Set to zero and not used.</td> </tr> </tbody> </table>	Subfield Name	Size (bytes)	Description	B	1/8 (1 bit)	Broadcast Flag: A client that doesn't know its own IP address at the time it sends its BOOTP request sets this flag to 1. This serves as an immediate indicator to the BOOTP server or relay agent that receives the request that it definitely should send its reply by broadcast.	Reserved	1 7/8 (15 bits)	Reserved: Set to zero and not used.
Subfield Name	Size (bytes)	Description									
B	1/8 (1 bit)	Broadcast Flag: A client that doesn't know its own IP address at the time it sends its BOOTP request sets this flag to 1. This serves as an immediate indicator to the BOOTP server or relay agent that receives the request that it definitely should send its reply by broadcast.									
Reserved	1 7/8 (15 bits)	Reserved: Set to zero and not used.									
CIAddr	4	Client IP Address: If the client has a current IP address that it plans to keep using, it puts it in this field. By filling in this field, the client is committing to responding to unicast IP datagrams sent to this address. Otherwise, it sets this field to all zero to tell the server it wants an address assigned. See the end of the detailed operation topic for important information on this field.									
YIAddr	4	“Your” IP Address: The IP address that the server is assigning to the client. This may be different than the IP address currently used by the client. See the topic describing BOOTP operation in detail for an explanation of what happens in that case.									
SIAddr	4	Server IP Address: The IP address of the BOOTP server sending a <i>BOOTREPLY</i> message.									

Table 187: BOOTP Message Format (*Page 3 of 3*)

Field Name	Size (bytes)	Description
GIAddr	4	Gateway IP Address: This field is used to route BOOTP messages when BOOTP relay agents facilitate the communication of BOOTP requests and replies between a client and a server on different subnets or networks. To understand the name, remember that the old TCP/IP term for “router” is “gateway”; BOOTP relay agents are typically routers. Note that this field is set to 0 by the client and should be ignored by the client when processing a <i>BOOTREPLY</i> . It specifically does not represent the server giving the client the address of a default router address to be used for general IP routing purposes.
CHAddr	16	Client Hardware Address: The hardware (layer two) address of the client sending a <i>BOOTREPLY</i> . It is used both to look up a device's assigned IP address and also possibly in delivery of a reply message.
SName	64	Server Name: The server sending a <i>BOOTREPLY</i> may optionally put its name in this field. This can be a simple text “nickname” or a fully-qualified DNS domain name (such as “myserver.organization.org”). Note that a client may specify a name in this field when it creates its request. If it does so, it is saying that it wants to get a reply only from the BOOTP server with this name. This may be done to ensure that the client is able to access a particular boot file stored on only one server
File	128	Boot Filename: Contains the full directory path and file name of a boot file that can be downloaded by the client to complete its bootstrapping process. The client may request a particular type of file by entering a text description here, or may leave the field blank and the server will supply the filename of the default file.
Vend	64	Vendor-Specific Area: Originally created to allow vendors to customize BOOTP to the needs of different types of hardware, this field is now also used to hold additional vendor-independent configuration information. See the next topic, on BOOTP vendor information extensions . It may be used by the client and/or the server.

As I mentioned in [the topic on BOOTP messaging](#), both requests and replies are encapsulated into UDP messages for transmission. The BOOTP standard specifies that the use of UDP checksums is optional. Using the checksum provides protection against data integrity errors and is thus recommended. This may cause unacceptable processing demands on the part of very simple clients, so the checksum can legally be skipped.

Similarly, for simplicity, BOOTP assumes that its messages will not be [fragmented](#). This is to allow BOOTP clients to avoid the complexity of reassembling fragmented messages. Since BOOTP messages are only 300 bytes in length, under the minimum MTU required for all TCP/IP links, this is not normally an issue.

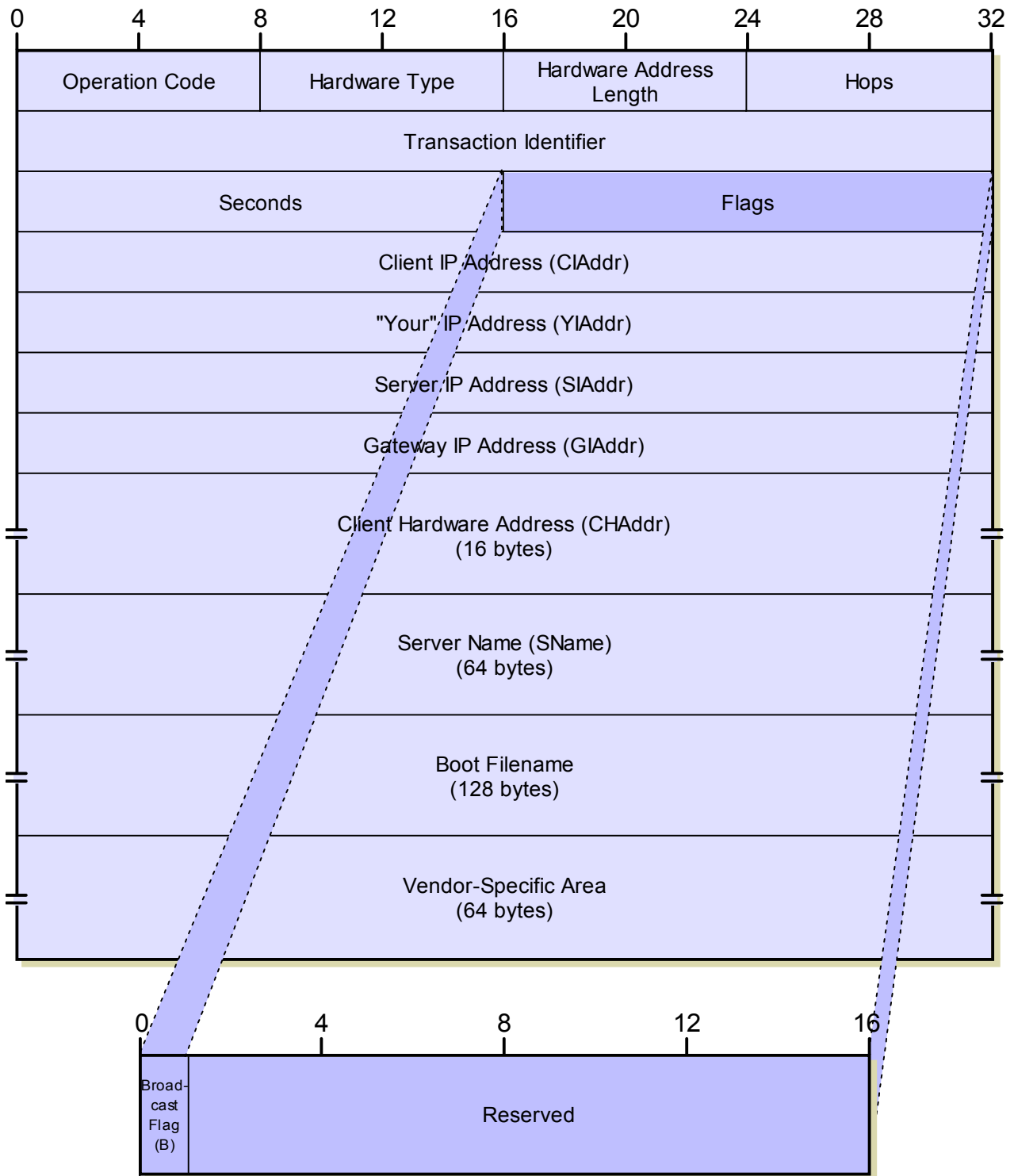

Figure 256: BOOTP Message Format

BOOTP Vendor-Specific Area and Vendor Information Extensions

The creators of the Boot Protocol realized that certain types of hardware might require additional information to be passed from the server to the client in order for the client to boot up. For this reason, they put into the BOOTP field format the 64-byte *Vend* field, also called the *Vendor-Specific Area*. Including this field makes BOOTP flexible, since it allows vendors to decide for themselves how they want to use the protocol, and to tailor it to their needs.

Traditional Use of the Vendor-Specific Area

A client can use the *Vend* field by asking for certain types of information in the field when composing its request. The server can then respond to these requests, and may also include parameters it wants the client to have even if they were not requested. The original BOOTP protocol does not define any structure for the *Vendor-Specific Area*, leaving this up to each manufacturer to decide.

Obviously, there is nothing preventing a client made by one manufacturer from trying to send a request to a server made by another one. If each one is expecting the *Vend* field to contain something different, the results will be less than satisfactory. Thus, for the *Vend* field to be used properly, both devices must be speaking the same “language” when it comes to the meaning of this field. This is done by setting the first four bytes of the field to a special value. Each manufacturer chooses its own “magic number” for this four-byte subfield, which is also sometimes called a “magic cookie”.



Note: Why is it called a magic “cookie”? I’m not sure, to be honest. I have heard tale that its origin may be the cookie that Alice ate to grow or shrink in the story *Alice in Wonderland*. Who knows. 😊

BOOTP Vendor Information Extensions

Including the *Vend* field in BOOTP gives the protocol extensibility for vendor-specific information. Unfortunately, the original field format didn't include any way of extending the information sent from a server to a client for **generic**, non-vendor-specific TCP/IP information.

This was a significant oversight in the creation of the protocol, because there are many types of information that a TCP/IP host needs when it starts up that really have nothing to do with its vendor. For example, when a host boots, we probably want it to be told the address of a [default router](#); the [subnet mask](#) for its local subnet; the address of a local [DNS server](#); the [MTU](#) of the local network; and much more. None of these things are vendor-specific, but there is no place to put them in the BOOTP reply message.

Since there was no “non-vendor-specific area” field in BOOTP, the decision was made to define a way of using the *Vendor-Specific Area* for communicating this additional generic information. This was first standardized in RFC 1048, and then refined in later RFCs as I explained in [the BOOTP overview](#). This scheme basically represents one particular way of

using the *Vend* field that most TCP/IP BOOTP implementations have chosen to adopt, regardless of their vendor. This enhancement is formally referred to as *BOOTP vendor information extensions*.

To clearly mark that this particular meaning of the *Vend* field is being used, a special, universal “magic cookie” value of “99.130.83.99” is inserted into the first four bytes of the field. Then, the remaining 60 bytes can contain a sequence of one or more *vendor information fields*. The overall structure of the *Vendor-Specific Area* when vendor information extensions are used is shown in [Figure 257](#).

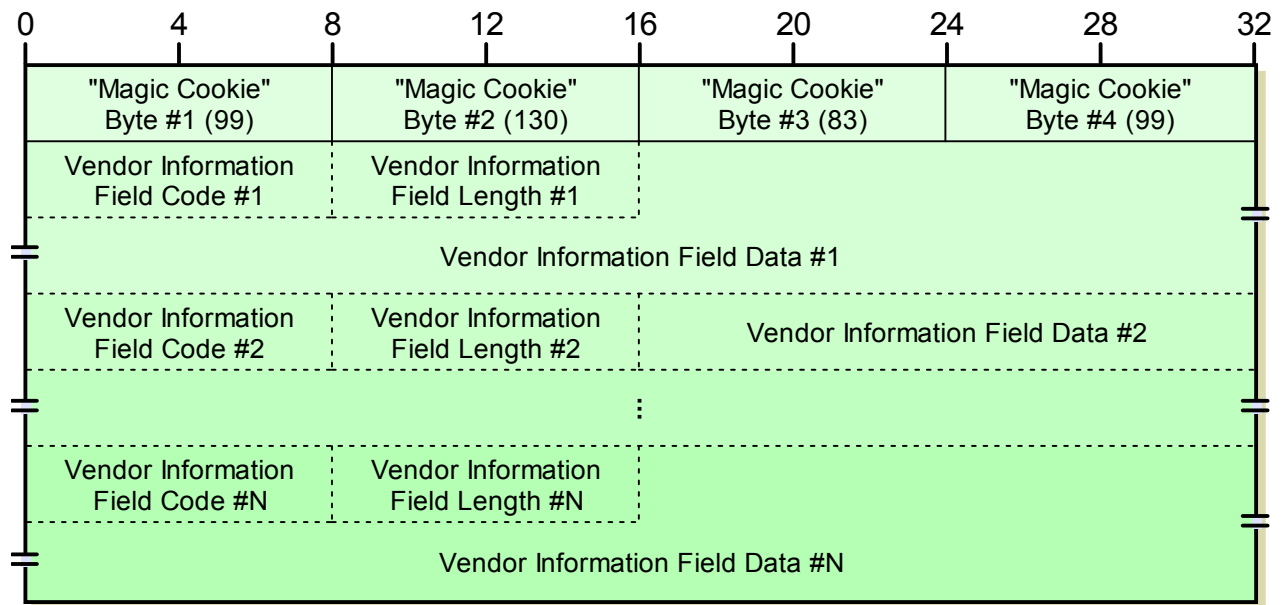

Figure 257: BOOTP Vendor-Specific Area Format Showing Vendor Information Fields

The BOOTP Vendor-Specific Area begins with the four-byte “magic cookie” and then contains a number of variable-length vendor information fields, each of which has the format shown above and in [Table 188](#).



Note: Despite the use of [dotted decimal notation](#) to represent the value “99.130.83.99”, this is *not* an IP address. It's just a marker, a “magic number” that is universally recognized.



Key Concept: The BOOTP message format includes a *Vend* field that was originally intended for vendor-specific customized fields. It was later changed to a place where additional generic information could be sent from a BOOTP server to a BOOTP client. Each such parameter is carried in a BOOTP *vendor information field*.

BOOTP Vendor Information Fields

Each vendor information field specifies a particular type of information to be communicated, and is encoded using a special subfield structure that specifies the field's type, length and value. This is a common method of specifying options, called *TLV-encoding* (for *type*, *length*, *value* of course). The same basic method is used for encoding IPv4 and IPv6 options. [Table 188](#) shows the structure and the common names for the subfields of each vendor information field.

Table 188: BOOTP Vendor Information Field Format

Subfield Name	Size (bytes)	Description
Code	1	Vendor Information Field Code: A single octet that specifies the vendor information field type.
Len	1	Vendor Information Field Length: The number of bytes in this particular vendor information field. This does not include the two bytes for the <i>Code</i> and <i>Len</i> fields.
Data	Variable	Vendor Information Field Data: The data being sent, which has a length indicated by the <i>Len</i> subfield, and which is interpreted based on the <i>Code</i> subfield.

There are two special cases that violate the field format of [Table 188](#). A *Code* value of 0 is used as a *pad*, when subfields need to be aligned on word boundaries; it contains no information. The value 255 is used to mark the end of the vendor information fields. Both of these codes contain no actual data, so to save space, when either is used just the single *Code* value is included; the *Len* and *Data* fields are omitted. A device seeing a *Code* value of 0 just skips it as filler; a device seeing a *Code* value of 255 knows it has reached the end of the vendor information fields in this *Vend* field.

The vendor information extensions of BOOTP have become so popular that the use of this field for sending extra generic information is pretty much standard. In fact, I am not even sure if anyone today still uses the *Vend* field solely for vendor-specific information at all.

When the vendor information extensions were introduced, one was created that points to a file where vendor-specific information can be found. This lets devices have the “best of both worlds”—they can use the standard vendor-independent fields and also incorporate vendor-specific fields (through the referenced file) where needed. Later, another field type was created that lets vendor-specific fields be mixed with vendor-independent ones right in a BOOTP message.

When DHCP was created, the same vendor extension mechanism was maintained and enhanced further, but instead of the field being called “vendor information extensions”, it was renamed to *Options*. (A much better name!) The BOOTP vendor information fields were retained in DHCP and new DHCP-specific options were defined. To avoid duplication, I have listed all the BOOTP vendor information fields and DHCP options in [a set of tables in the section on DHCP](#). This includes a discussion of how vendor-specific and vendor-

independent information can be mixed as I mentioned in the previous paragraph. You may also want to read [the topic describing DHCP options](#) and discussing how they were created from BOOTP vendor information extensions.

BOOTP Relay Agents (Forwarding Agents)

One reason why the [Reverse Address Resolution Protocol \(RARP\)](#) was quickly replaced by BOOTP is that RARP required the client being configured and the server providing it with an IP address to be on the same physical network. Sure, this is fine when you run a small organization with 10 machines. In this case, all 10 are probably on the same physical network anyway. Larger networks must be divided into multiple physical networks for efficiency, however. RARP would require a separate RARP server for each network, meaning having to duplicate all the functions of a single server onto multiple machines. Worse yet, all the configuration information would also be duplicated, and any changes would have to be made to all the different servers each time.

Why BOOTP Relay Agents Are Necessary

Unlike RARP, BOOTP is designed to allow the BOOTP server and the clients it serves to be on different networks. This centralizes the BOOTP server and greatly reduces the amount of work required of network administrators. However, implementing this feature means increasing the complexity of the protocol. In particular, we need to involve a “third party” device in the configuration process.

You might rightly wonder why this would be the case. Sure, RARP is a low-level protocol that works at the link layer, so that explains why it would have problems putting the client and server on different physical networks. But wasn't the whole point of making BOOTP a high-level protocol that it was able to use IP? And if BOOTP uses IP, can't we sent from one network to another arbitrarily just like any IP-based messaging protocol?

The answer is that even though we are indeed using IP and UDP, BOOTP still has one of the same issues that RARP had: a reliance on *broadcasts*. The client usually doesn't know the address of a server, so it has to [send out its request as a broadcast](#), saying in essence, “can anyone hear this and give me the information I need?” For efficiency reasons, routers do not route such broadcasts, as they would clog the network. This means that if the server and client are not on the same network, the server can't hear the client's broadcast. Similarly, if the server ever did get the request and broadcast its reply back to the client, the client would never get it anyway.

The Function of BOOTP Relay Agents

To make this all work, then, we need ***something*** to act as an intermediary between the client and the server: a *BOOTP relay agent*. The job of a BOOTP relay agent is to sit on a physical network where BOOTP clients may be located and act as a proxy for the BOOTP server. The agent gets its name because it relays messages between the client and server, and thus enables them to be on different networks.



Note: BOOTP relay agents were originally called *forwarding agents*. That name was considered too easy to cause confusion between BOOTP operation and the general “forwarding” behavior of regular routers. RFC 1542 changed the name to make explicit the fact that BOOTP relaying was not the same as conventional IP datagram forwarding.

In practice, a BOOTP relay agent is not usually a separate piece of hardware. It's a software module that runs on an existing piece of hardware that performs other functions. It is common for BOOTP relay agent functionality to be implemented on an IP router. In that case, the router is acting both as a “regular” router and also playing the **role** of a BOOTP agent. The forwarding functions required of a BOOTP relay agent are distinct from the normal IP datagram forwarding tasks of a router (though there are certain similarities as we will see.)

Naturally, the placement of the client and server on different networks and the presence of a relay agent changes [the normal request/reply process of BOOTP](#) significantly. A couple of specific fields in the BOOTP message format are used to control the process. RFC 951 was rather vague in describing how this process works, so RFC 1542 described it in much more detail.



Key Concept: Since BOOTP uses broadcasts, the BOOTP client and BOOTP server must be on the same physical network to be able to hear each others broadcasted transmissions. For a client and server on different networks to communicate, a third party is required to facilitate the transaction: a *BOOTP relay agent*. This device, which is often a router, listens for transmissions from BOOTP clients and relays them to the BOOTP server. The server responds back to the agent, which then sends the server's response back to the client.

Normal BOOTP Operation Using a Relay Agent

The following shows, in simplified form, a revised set of BOOTP operation steps when a relay agent is involved. To keep the size of this topic manageable I have omitted the details of the basic request/reply process to focus on the relaying functionality, which you can also see graphically in [Figure 258](#):

1. **Client Creates Request:** The client machine creates its request normally. The existence of a relay agent is totally transparent to the client.
2. **Client Sends Request:** The client broadcasts the *BOOTREQUEST* message by transmitting it to address 255.255.255.255. (Note that in the case where a client already knows both its own address and the address of a BOOTP server, we don't need the relay agent at all—both the request and reply can be sent unicast over an arbitrary internetwork.)

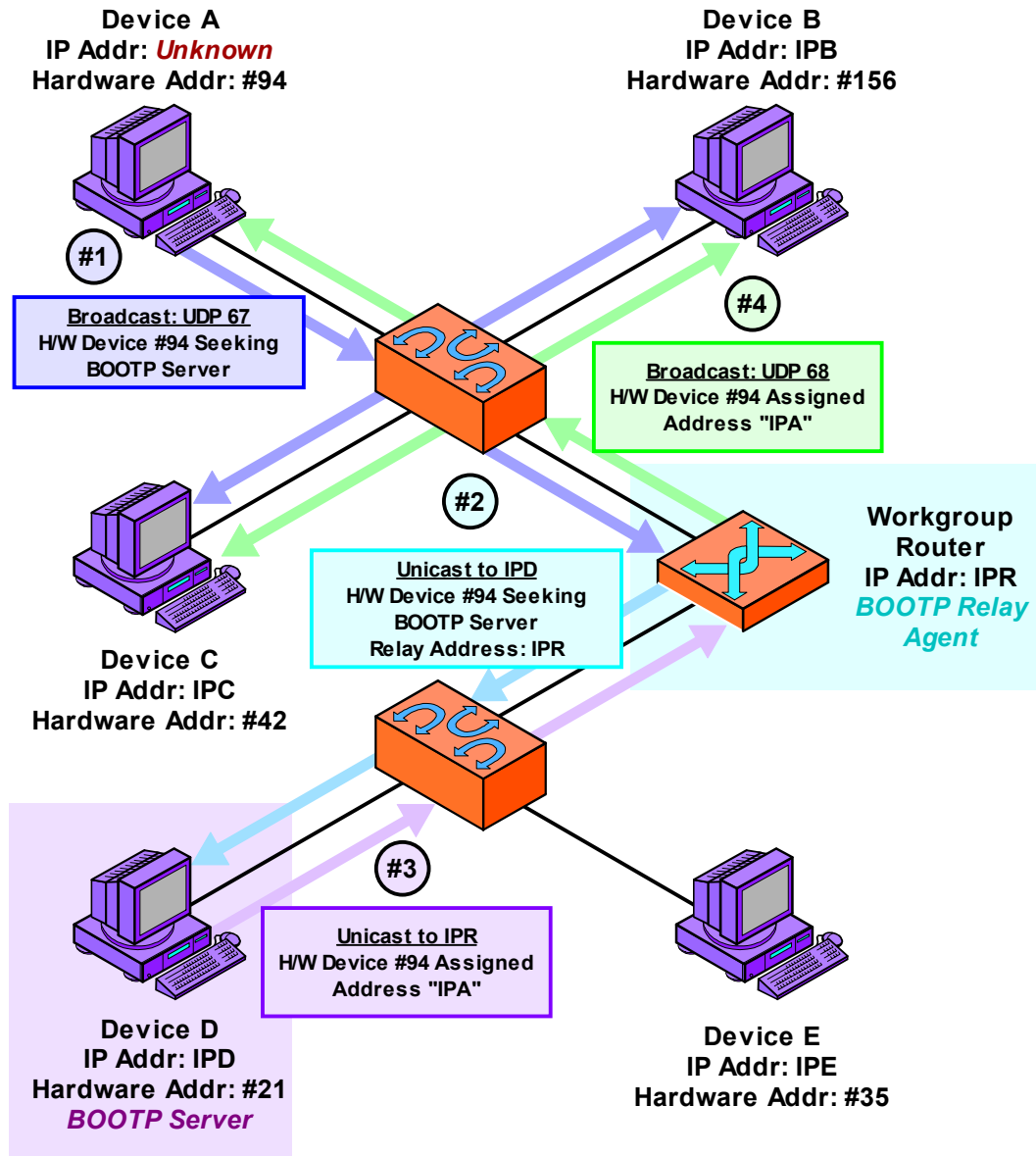

Figure 258: BOOTP Operation Using A Relay Agent

In this example, Device A is trying to access a BOOTP server, but the only one is on a different network; the two are connected by a workgroup router that is configured to act as a BOOTP relay agent. Device A broadcasts its request, which the router receives. It relays the request to the BOOTP server, Device D, and puts its own IP address (IPR) into the BOOTP *GIAddr* field. The BOOTP server sends the reply back to the router using address *IPR*. The router then broadcasts it on Device A's local network so that A can receive it.

3. **Relay Agent Receives Request and Processes It:** The BOOTP relay agent on the physical network where the client is located is listening on UDP port 67 on the server's behalf. It processes the request as follows:
 - It checks the value of the *Hops* field. If the value is less than or equal to 16, it increments it. If the value is greater than 16, it discards the request and does nothing further.

-
- ☉ It examines the contents of the *GIAddr* field. If this field is all zeroes, it knows it is the first relay agent to handle the request and puts its own IP address into this field. (If the agent is a router it has more than one IP address, so it chooses the one of the interface upon which it received the request.)
4. **Relay Agent Relays Request:** The relay agent sends the BOOTP request to the BOOTP server. If the relay agent knows the server's IP address it will send it unicast directly to the server. Otherwise, if the agent is a router, it may choose to broadcast the request on a different interface from the one on which it received the request. In the latter case, it is possible that multiple relay agents may be required to convey the request to the server. See below for more on this.
 5. **Server Receives Request and Processes It:** The BOOTP server receives the relayed request from the BOOTP relay agent. It processes it as normal.
 6. **Server Creates Reply:** The server creates a reply message as normal.
 7. **Server Sends Reply:** Seeing that the *GIAddr* field in the request was non-zero, the server knows the request was relayed. Instead of trying to send its reply back to the client that sent the request, it transmits the reply unicast back to the relay agent specified in *GIAddr*.
 8. **Relay Agent Relays Reply:** The BOOTP relay agent transmits the *BOOTREPLY* message back to the client. It does this either unicast or broadcast, depending on the value of the *CIAddr* field and the *B* (*Broadcast*) flag, just like a server does in the non-relay case.

Relaying BOOTP Requests Using Broadcasts

The simplest case of relaying is when each network has a relay agent that knows the IP address of the BOOTP server. The relay agent “captures” the request in step 3 above, and sends it directly to the BOOTP server, wherever it may be on the network. The request is relayed as a regular unicast UDP message and routed to the BOOTP server. The BOOTP server's reply is routed back to the BOOTP relay agent just like any UDP message in an IP datagram, and the relay agent forwards the reply.

It is also possible to set up BOOTP relay agents to relay requests even if they don't know the BOOTP server's address. These agents take requests received on one network and relay them to the next, where they expect another agent to continue the relaying process until a BOOTP server is reached. For example, suppose we have a set of three networks. Network *N1* is connected to Network *N2* using Router *RA*, and *N2* connects to *N3* using Router *RB*. Both of these routers function as relay agents but don't know the IP address of the BOOTP server. Here's what would happen if a client on *N1* sent a request and the server was on *N3*:

1. The client would send its request.
2. *RA* would capture the request and put its address into *GIAddr*. It would increment the *Hops* field to a value of 1 and then broadcast the request out on Network *N2*.
3. *RB* would capture this request. It would see there is already an address in *GIAddr* so it would leave that alone. It would increment the *Hops* field to 2 and broadcast the request on Network *N3*.

-
4. The BOOTP server would receive the request, process it and return the reply directly back to *RA*.
 5. *RA* would relay the reply back to the client.

As you can see, the purpose of the *Hops* field is to ensure that errant requests don't circle around the network endlessly. Each relay agent increments it and if the value of 16 is ever exceeded, the request is dropped. You can also see that any relay agents other than the first are involved only for handling the request; the reply is sent unicast back to the agent closest to the client.

Incidentally, if this multiple-step relaying process sounds like IP routing (only using broadcasts), and the *Hops* field sounds like the *Time To Live* field in an [IP datagram](#), then you've been paying attention. It is essentially the same idea.



TCP/IP Dynamic Host Configuration Protocol (DHCP)

In some ways, technological advancement can be considered more a journey than a destination. When a particular technology is refined or replaced with a superior one, it's usually only a matter of time before it too is replaced with something better. And so it was with the [TCP/IP Boot Protocol](#). While BOOTP was far more capable than the protocol it replaced ([RARP](#)), after a number of years BOOTP itself was replaced with a new TCP/IP configuration protocol: the *Dynamic Host Configuration Protocol (DHCP)*.

Where BOOTP represented a revolutionary change from RARP, DHCP is more of an evolution of BOOTP. It was built using BOOTP as a foundation, with the same basic message format. The most significant addition in DHCP is the ability to *dynamically* assign addresses to clients and to centrally manage them. It is this capability that both gives DHCP its name, and makes it so powerful. DHCP today is the standard TCP/IP host configuration protocol and is used in everything from single-client home networks to enterprise-class internetworks.

In this section I describe the concepts behind DHCP and explain how it works in detail. I begin with a topic that provides an overview of the protocol, discussing its history and the standards that define it. I then have four subsections that describe DHCP concepts and operation. The first talks about the different ways DHCP can assign addresses, with a focus on dynamic addressing. The second discusses how DHCP operates, including a look at configuration parameter management and the procedures for allocating addresses and managing those allocations. The third describes DHCP messaging and illustrates the DHCP message format. The fourth gets into more of the details of DHCP clients and servers, and also looks at special features and issues with DHCP. Finally, I conclude with a topic describing how DHCP changes to support the new IP version 6.



Related Information: Since DHCP builds upon BOOTP, they have a number of things in common. For example, DHCP makes use of [BOOTP relay agent functionality](#), and DHCP options are basically the same as [BOOTP vendor information fields](#). Since DHCP is the more common of the two protocols, I have tried to be complete in describing the operation of these features here, highlighting especially any differences between how they work for DHCP compared to BOOTP.

However, I have avoided duplicating the history and reasoning for the existence of many of these features. Since BOOTP came first, I have placed more of the historical information in the BOOTP section. In general, if you plan to read about DHCP as well as BOOTP, I recommend reading [the section on BOOTP first](#). If you don't plan to read up on BOOTP, you may wish to check [the topic on DHCP/BOOTP interoperability](#) instead.

DHCP Overview, Motivation, History and Standards

BOOTP represents a significant improvement over RARP because it solves so many of RARP's problems. BOOTP is a higher-layer protocol, not hardware-dependent like RARP. It can support sending extra information beyond an IP address to a client to enable customized configuration. Also, through the use of **BOOTP relay agents**, it allows a large organization to use just one or two BOOTP servers to handle clients spread out over many physical networks.

In so doing, BOOTP effectively solves one of the major classes of problems that administrators have with manual configuration: the "I have to go configure each host myself" issue. It allows "dumb" (storageless) hosts to configure themselves automatically, and saves techies the hassles of needing to trek to each host individually to specify important configuration parameters.

The Need for Dynamic Address Assignment

BOOTP normally uses a static method of determining what IP address to assign to a device. When a client sends a request, it includes its hardware address, which the server looks up in a table to determine the IP address for that client. (It is possible for BOOTP to use other methods of determining the relationship between an IP and hardware address, but static mapping is usually used.) This means BOOTP works well in relatively static environments, where changes to the IP addresses assigned to different devices are infrequent. Such networks were basically the norm in the 1980s and early 1990s.

Over time, many networks quickly started to move away from this model, for a number of reasons. As computers became smaller and lighter, it was more common for them to move from one network to another, where they would require a different address using the new network's **network ID**. Laptop and even palmtop computers could literally move from one network to another many times per day. Another major issue was the **looming exhaustion of the IP address space**. In many organizations, permanently assigning a static IP address to each and every computer that might connect to their network was a luxury they could not afford.

In many organizations, trying to keep track of constant IP address changes became a daunting task in and of itself. BOOTP, with its static table of mappings between hardware addresses and IP addresses, simply wasn't up to the task. It also offered no way to reuse addresses; once an address had been assigned, a device could keep it forever, even if it were no longer needed.

DHCP: Building on BOOTP's Strengths

A new host configuration protocol was needed to serve modern networks, which would move away from static, permanent IP address assignment. The IETF supplied this in the form of the *Dynamic Host Configuration Protocol (DHCP)*, first formalized in RFC 1541, October 1993. (Actually, it was really originally specified in RFC 1531 in that same month, but due to minor errors in 1531 the standard was quickly revised and 1541 published.)

Of course, it's not like BOOTP was a bad protocol or anything. It certainly worked well, for what it was capable of doing. It was also already widely deployed. Given these factors, it really made no sense to start over from scratch with DHCP. This was especially so given that such a decision would have meant dealing with the inevitable “painful” transition, as well as compatibility problems associated with having both BOOTP and DHCP around for many years.

So, instead of tossing out BOOTP, DHCP was built upon it as a foundation. In its simplest form, DHCP consists of two major components: an address allocation mechanism, and a protocol that allows clients to request, and servers to provide, configuration information. DHCP performs both functions in a manner similar to BOOTP, but with improvements.

Overview of DHCP Features

The most significant changes are in the area of [address allocation](#), which is enhanced through the support for *dynamic* address assignment mentioned above. Rather than using a static table that absolutely maps hardware addresses to IP addresses, a *pool* of IP addresses is used to dynamically allocate addresses. This allows addresses to be shared amongst many machines, as well as providing other benefits. Dynamic addressing allows IP addresses to be efficiently allocated, and even shared amongst devices. At the same time, DHCP still supports static mapping of addresses for devices where this is needed.

The [overall operation and communication between clients and servers](#) is again similar to that used by BOOTP, but with changes. The same basic request/reply protocol using UDP was retained for communicating configuration information, but additional message types were created to support DHCP's enhanced capabilities. BOOTP relay agents can be used by DHCP in a manner very similar to how they are used by BOOTP clients and server. The vendor information extensions from BOOTP were retained as well, but were formalized, renamed *DHCP options*, and extended to allow the transmission of much more information.

The result of all of this development effort is a widely-accepted, universal host configuration protocol for TCP/IP that retains compatibility with BOOTP while significantly extending its capabilities. Today, DHCP is found on millions of networks worldwide. It is used for everything from assigning IP addresses to multi-thousand-host corporate networks, to allowing a home Internet access router to automatically providing the correct Internet configuration information to a single user's computer.

The original DHCP specification was revised in March 1997 with the publishing of RFC 2131, also entitled *Dynamic Host Configuration Protocol*. This standard defined another new DHCP message type to allow [active IP hosts to request additional configuration information](#). It also made several other small changes to the protocol. Since that time numerous other DHCP-related RFCs have been published, most of which either define new DHCP option types (other kinds of information DHCP servers can send to DHCP clients) or slightly refine the way that DHCP is used in particular applications.



Key Concept: The *Dynamic Host Configuration Protocol (DHCP)* is the host configuration protocol currently used on modern TCP/IP internetworks. It was based on BOOTP and is similar to its predecessor in many respects, including the use of request/reply message exchanges and a nearly-identical message format. However, DHCP includes added functionality, the most notable of which is *dynamic address assignment*, which allows clients to be assigned IP addresses from a shared pool managed by a DHCP server.



DHCP Address Assignment and Dynamic Address Allocation and Management

The Dynamic Host Configuration Protocol (DHCP) was created as an extension of the older Boot Protocol (BOOTP). The first word in “DHCP” describes the most important new capability that was added to BOOTP: the ability to assign IP addresses *dynamically*. Moving from a static to a dynamic address allocation model dramatically changes the way we deal with IP addresses in DHCP. Host configuration is transformed from a simple way to tell a host what its address and other parameters are, to a complete tool for managing IP addresses in an organization.

In this section I begin my detailed look at DHCP by describing the concepts behind DHCP address assignment and leases. I begin with a look at how DHCP address assignment works, and a description of the three DHCP address allocation mechanisms. I then delve into DHCP leases and the policies and techniques used to decide how to implement DHCP leasing. I provide an overview of the lease “life cycle” from start to finish, and describe the two DHCP lease timers that help control the process. Finally, I describe DHCP lease address pools and ranges and the general concepts behind address management.

DHCP Address Assignment and Allocation Mechanisms

The two main functions of the Dynamic Host Configuration Protocol are to provide a mechanism for assigning addresses to hosts, and a method by which clients can request addresses and other configuration data from servers. Both functions are based on the ones implemented in DHCP's predecessor, BOOTP, but the changes are much more significant in the area of address assignment than they are in communication. It makes sense to start our look at DHCP here, since this will naturally lead us into a detailed discussion of defining characteristic of DHCP: *dynamic addressing*.

DHCP Address Allocation Mechanisms

Providing an IP address to a client is the most fundamental configuration task performed by a host configuration protocol. To provide flexibility for configuring addresses on different types of clients, the DHCP standard includes three different address allocation mechanisms:

- ☉ **Manual Allocation:** A particular IP address is pre-allocated to a single device by an administrator. DHCP only communicates the IP address to the device.
- ☉ **Automatic Allocation:** DHCP automatically assigns an IP address permanently to a device, selecting it from a pool of available addresses.
- ☉ **Dynamic Allocation:** DHCP assigns an IP address from a pool of addresses for a limited period of time chosen by the server, or until the client tells the DHCP server that it no longer needs the address.

I don't really care for the names “automatic” and “dynamic” allocation, because they don't do a good job of clearly conveying the differences between these methods. Both can be considered “automatic” because in each the DHCP server assigns an address with no

administrator intervention required. The real difference between them is only in how long the IP address is retained, and therefore, whether a host's address varies over time. I think better names would be “static/permanent automatic allocation” and “dynamic/temporary automatic allocation”. But then, nobody really cares much what I think. ☺

Regardless of what you call them, all three of these methods exist for configuring IP hosts using DHCP. It is not necessary for an administrator to choose one over the others. Instead, he or she will normally combine the methods, using each for the devices where it makes the most sense.

Manual Allocation

Manual allocation is the simplest method, and is equivalent to [the method BOOTP uses for address assignment](#). Each device has an address that an administrator gives it ahead of time, and all DHCP does is look up the address in a table and send it to the client for which it is intended. This technique makes the most sense for devices that are “mainstays” of the network, such as servers and routers. It is also appropriate for other devices that for whatever reason must have a stable, permanent IP address.

Okay, now here's a fair question you might have. DHCP acts basically like BOOTP in the case of manual allocation. But BOOTP was created for devices that needed help with configuration. Servers and routers are complex devices with their own internal storage, and obviously don't need a DHCP server to tell them their IP address like a diskless workstation does, so why bother using DHCP for them at all?

Well, in fact, you could just manually assign the address to the device directly and tell DHCP to ignore those addresses. However, using DHCP for manual assignments yields a different benefit: an **administrative** one. It keeps all the IP address information centralized in the DHCP address database, instead of requiring an administrator to go from machine to machine checking addresses and ensuring there are no duplicates. Updates can also be made in a single place as well.

Dynamic Allocation

While manual allocation is possible in DHCP, dynamic allocation is its real “raison d'être”. An administrator sets up a *pool* (usually a range or set of ranges) of IP addresses that are available for use. Each client that is configured to use DHCP contacts the server when it needs an IP address. The server keeps track of which IP addresses are already assigned, and *leases* one of the free addresses from the pool to the client. The server decides the amount of time that the lease will last. When the time expires, the client must either request permission to keep using the address (renewing the lease) or must get a new one. This matter of leases and how they are handled will be the subject of most of the rest of this section.

Dynamic allocation is the method used for most client machines in modern DHCP-enabled IP internetworks. It offers numerous benefits, including the following:

-
- ④ **Automation:** Each client can be automatically assigned an IP address when it is needed with no intervention and no need for an administrator to manually decide which address goes with which client.
 - ④ **Centralized Management:** All the IP addresses are managed by the DHCP server. An administrator can easily look to see which devices are using which addresses and perform other network-wide maintenance tasks.
 - ④ **Address Reuse and Sharing:** By limiting the amount of time that each device holds an IP address, the DHCP server can ensure that the pool of IP addresses is only used by devices actively using the network. After a period of time, addresses no longer being used are returned to the pool, allowing other devices to use them. This allows an internetwork to support a total number of devices larger than the number of IP addresses available, as long as not all the devices connect to the internetwork at the same time.
 - ④ **Portability and Universality:** BOOTP (and DHCP manual allocation) both require that the DHCP server “know” the identity of each client that connects to it, so the server can find the client's assigned address. With dynamic allocation, there are no predefined allocations, so any client can request an IP address. This inherently makes dynamic allocation the ideal choice for supporting mobile devices that travel between networks.
 - ④ **Conflict Avoidance:** Since IP addresses are all assigned from a pool that is managed by the DHCP server, IP address conflicts are avoided.

The last point, of course, assumes that all the clients use DHCP. The administrator must ensure that the address pool is not used by non-DHCP devices. More about this in [a later topic on DHCP address ranges and address management](#).

Automatic Allocation

The third option, automatic allocation, can be used in cases where there are enough IP addresses for each device that may connect to the network, but where devices don't really care what IP address they use. Once an address is assigned to a client, that device will keep using it. Automatic allocation can be considered a “special case” of dynamic allocation: it is essentially dynamic allocation where the time limit on the use of the IP address by a client (the lease length) is “forever”.

In practice, automatic allocation is not used nearly as much as dynamic allocation, for a simple reason: automatically assigning an IP address to a device permanently is a risky move. Most administrators feel it is better to use manual allocation for the limited number of machines that really need a permanent IP address assignment, and dynamic addressing for others. We'll discuss this more in the next topic.



Key Concept: DHCP defines three basic mechanisms for address assignment. *Dynamic allocation* is the method most often used, and works by having each client *lease* an address from a DHCP server for a period of time; the server chooses the address dynamically from a shared address pool. *Automatic allocation* is like dynamic allocation but the address is assigned permanently instead of being leased. *Manual allocation* pre-assigns an address to a specific device, just as BOOTP does, and is normally used only for servers and other permanent, important hosts.

DHCP Leases, Lease Length Policies and Management

Of the [three address allocation methods](#) supported by DHCP, dynamic address allocation is by far the most popular and important. The significance of the change that dynamic addressing represents to how IP addresses are used in TCP/IP can be seen in the semantics of how addresses are treated in DHCP. Where conventionally a host was said to **own** an IP address, when dynamic address allocation is used, hosts are said instead to **lease** an address.

The notion of a “lease” conveys very accurately the difference between dynamic allocation and the other types. A host no longer is strictly “entitled” to a particular address, with a server merely telling it what the address is. In DHCP, the server remains the real owner of all the IP addresses in the address pool, and merely gives permission for a client to use the address for a period of time. The server guarantees that it will not try to use the address for another client only during this time. The client is responsible for taking certain actions, as we will see later in this section, if it wants to continue using the address. If it does not successfully reacquire permission for using the address after a period of time, it must stop using it, or risk creating an IP address conflict on the network.



Key Concept: DHCP’s most significant new feature is dynamic allocation, which changes the way that IP addresses are managed. Where in traditional IP each device owns a particular IP address, in DHCP the server owns all the addresses in the address pool, and each client *leases* an address from the server, usually only for a limited period of time.

DHCP Lease Length Policy and Choosing Lease Durations

When dynamic address allocation is used, the administrator of the network must provide parameters to the DHCP server to control how leases are assigned and managed. One of the most important decisions to be made is the *lease length policy* of the internetwork: how long the administrator wants client leases to last. There of course is no “right answer”—the right lease length interval depends on the network, the server, and the clients. The choice of lease time, like so many other networking parameters, boils down to a trade-off between *stability* and *allocation efficiency*.

The primary benefit of using long lease times is that the addresses of devices are relatively stable. A device doesn't have to worry about its IP address changing all the time—and neither does its user. This is a significant advantage in many cases, especially when it is necessary for the client to perform certain server functions, accept incoming connections, or use a DNS domain name (ignoring for the moment [dynamic DNS](#) capabilities). In those situations, having the IP address of a device moving all over the place can cause serious complications.

The main drawback of using long leases is that they substantially increase the amount of time that an IP address, once no longer needed, is “tied up” before it can be reused. In the worst case scenario, the amount of “wasted time” for an allocation can be almost as long as the lease itself. If we give a device a particular address for six months and after two weeks the device is shut down and no longer used, the IP address that it was using is still “unavailable” for another five and a half more months.

For this reason, many administrators prefer to use short leases. This forces a client to continually renew the lease as long as it needs it. When it stops asking for permission again, the address is quickly put back into the pool. This makes shorter leases a better idea in environments where the number of addresses is limited and must be conserved. The drawback, of course, is the opposite of the benefit of long leases: constantly-changing IP addresses.

Common Lease Durations

The administrator need not pick from “short” and “long” lease durations. He or she can “compromise” by choosing a number that best suits the network. Some examples of lease times and the reasoning behind them:

- ☉ **One Hour Or Less:** Ensures maximum IP address allocation efficiency in a very dynamic environment where there are many devices connecting and disconnecting from the network, and the number of IP addresses is limited.
- ☉ **One Day:** Suitable for situations where “guest” machines typically stay for a day, to increase IP efficiency when many employees work part-time, or otherwise to ensure that every day each client must ask again for permission to use an address.
- ☉ **Three Days:** This is the default used by Microsoft. This alone makes it a popular choice.
- ☉ **One Week:** A reasonable “compromise” between the shorter and longer times.
- ☉ **One Month:** Another “compromise”, closer to the longer end of the lease time range.
- ☉ **Three Months:** Provides reasonable IP address stability so that addresses don't change very often in reasonably static environments. Also a good idea if there are many IP addresses available and machines are often turned off for many days or weeks at a time. May be used in a university setting to ensure that IP addresses of returning students are maintained over the summer recess.
- ☉ **One Year:** An approximation of an “infinite” lease; see below.

Assigning Lease Length By Client Type

In fact, not only is the administrator not restricted to a limited number of possible lease durations, it is not necessary for the administrator to choose a constant lease length policy for all clients. Depending on the capabilities of the DHCP server, an administrator may select different lease lengths for certain clients than others. For example, the administrator may decide to use long leases for desktop computers that are permanently assigned to a particular subnet and not moved, and a pool of short-leased addresses for notebooks and “visitors”. In some DHCP implementations this can be done by assigning clients to particular “classes”. Of course, this requires more work (and may even require multiple servers.)

Factoring Lease Renewal Into Lease Length Selection

In selecting a lease time policy, the administrator must also bear in mind that by default, after half the length of a lease, the client will begin attempting to renew the lease. This may make it more advisable to use a longer lease time, to increase the amount of time between when a client tries to renew the lease and when the lease expires. For example, in a network with a single DHCP server, an administrator may want to use leases no shorter than eight hours. This provides a four-hour “window” for maintenance on the server without leases expiring.

When a lease is very short, such as minutes or hours, it will typically expire when a client machine is turned off for a period of time, such as overnight. Longer leases will persist across reboots. The client in this case will still contact the DHCP server each time it is restarted to *reallocate* the address—confirm that it may continue using the address it was assigned.



Key Concept: A key decision that a network administrator using DHCP must make is what the network’s lease length policy will be. Longer leases allow devices to avoid changing addresses too often, while shorter leases are more efficient in terms of reallocating addresses that are no longer required. An administrator can choose from a variety of different lease times, and may choose longer leases for some devices than for others.

Issues With “Infinite” Leases

In addition to choosing a particular lease length number, it is possible to specify an “infinite” lease length duration for certain clients. This effectively turns dynamic allocation into automatic allocation for a particular client. As I said in [the previous topic](#), however, this is generally not done. The reason is that an infinite lease never expires, and as the old saw goes, “never is a long time”. ☺

Permanently assigning an IP address from a pool is a somewhat “risky” move, because once assigned, if anything occurs that causes that address to be no longer used, it can never be recovered. A worst-case scenario would be a visitor to a company site who plugs

a notebook computer in to the network to check e-mail or transfer a file. If that machine is assigned an IP address using automatic allocation, the visitor will “take it with him” when he leaves. Obviously, not a great idea.

For this reason, most administrators prefer to use dynamic allocation instead, with addresses set to a very long time frame, such as a year or two years. This is considered “near enough to infinity” that it approximates a permanent assignment, but allows an IP address to *eventually* be recovered if a device for whatever reason stops using it. In such a policy, anything that really, truly needs a permanent assignment is given an address using *manual* assignment, which requires a conscious decision to dedicate the address to a particular device.



Related Information: For a little more information related to lease length selection, see [the topic on DHCP server implementation problems and issues](#).

DHCP Lease "Life Cycle" Overview (Allocation, Reallocation, Renewal, Rebinding and Release) and Lease Timers

The use of dynamic address allocation in DHCP means a whole new way of thinking about addresses. A client no longer owns an address, but rather *leases* it. This means that when a client machine is set to use DHCP dynamic addressing, it can never assume that it has an address on a permanent basis. Each time it powers up, it must engage in communications with a DHCP server to begin or confirm the lease of an address. It also must perform other activities over time to manage this lease and possibly terminate it.

The DHCP Lease "Life Cycle"

Calling dynamic address assignments *leases* is a good analogy, because a DHCP IP address lease is similar to a “real world” lease in a number of respects. For example, when you rent an apartment, you sign the lease. Then you use the apartment for a period of time. Typically, assuming you are happy with the place, you will *renew* the lease before it expires, so you can keep using it. If by the time you get near the end of the lease the owner of the apartment has not allowed you to renew it, you will probably lease a different apartment to ensure you have somewhere to live. And if you decide, say, to move out of the country, you may terminate the lease and not get another at all.

DHCP leases follow a similar lease “life cycle”, which generally consists of the following phases:

- ☉ **Allocation:** A client begins with no active lease, and hence, no DHCP-assigned address. It acquires a lease through a process of *allocation*.
- ☉ **Reallocation:** If a client already has an address from an existing lease, then when it reboots or starts up after being shut down, it will contact the DHCP server that granted it the lease to confirm the lease and acquire operating parameters. This is sometimes called *reallocation*; it is similar to the full allocation process but shorter.

-
- ⦿ **Normal Operation:** Once a lease is active, the client functions normally, using its assigned IP address and other parameters during the “main part” of the lease. The client is said to be *bound* to the lease and the address.
 - ⦿ **Renewal:** After a certain portion of the lease time has expired, the client will attempt to contact the server that initially granted the lease, to *renew* the lease so it can keep using its IP address.
 - ⦿ **Rebinding:** If renewal with the original leasing server fails (because, for example, the server has been taken offline), then the client will try to *rebind* to any active DHCP server, trying to extend its current lease with any server that will allow it to do so.
 - ⦿ **Release:** The client may decide at any time that it no longer wishes to use the IP address it was assigned, and may terminate the lease, *releasing* the IP address. Like the apartment-renter moving out of the country, this may be done if a device is moving to a different network, for example. Of course, unlike DHCP servers, landlords usually don't let you cancel a lease at your leisure, but hey, no analogy is perfect.

Figure 259 illustrates the DHCP life cycle using an example that spans three leases.

Renewal and Rebinding Timers

The processes of renewal and rebinding are designed to ensure that a client's lease can be extended before it is scheduled to end, so no loss of functionality or interruption occurs to the user of the client machine. Each time an address is allocated or reallocated, the client starts two timers that control the renewal and rebinding process:

- ⦿ **Renewal Timer (T1):** This timer is set by default to 50% of the lease period. When it expires, the client will begin the process of renewing the lease. It is simply called “T1” in the DHCP standards.
- ⦿ **Rebinding Timer (T2):** This timer is set by default to 87.5% of the length of the lease. When it expires, the client will try to rebind, as described above. It is given the snappy name “T2” in the DHCP standards.

Naturally, if the client successfully renews the lease when the *T1* timer expires, this will result in a “fresh lease”, and both timers will be reset. *T2* only comes into play if the renewal is not successful. It is possible to change the amount of time to which these timers are set, but obviously *T1* must expire before *T2*, which must in turn expire before the lease itself ends. These usually are not changed from the default, but may be modified in certain circumstances.



Key Concept: DHCP leases follow a conceptual *life cycle*. The lease is first assigned to the client through a process of *allocation*; if the device later reboots it will *reallocate* the lease. After a period of time controlled by the *renewal timer (T1)*, the device will attempt to *renew* its lease with the server that allocated it. If this fails, the *rebinding timer (T2)* will go off and the device will attempt to *rebind* the lease with any available server. The client may also *release* its IP address if it no longer needs it.

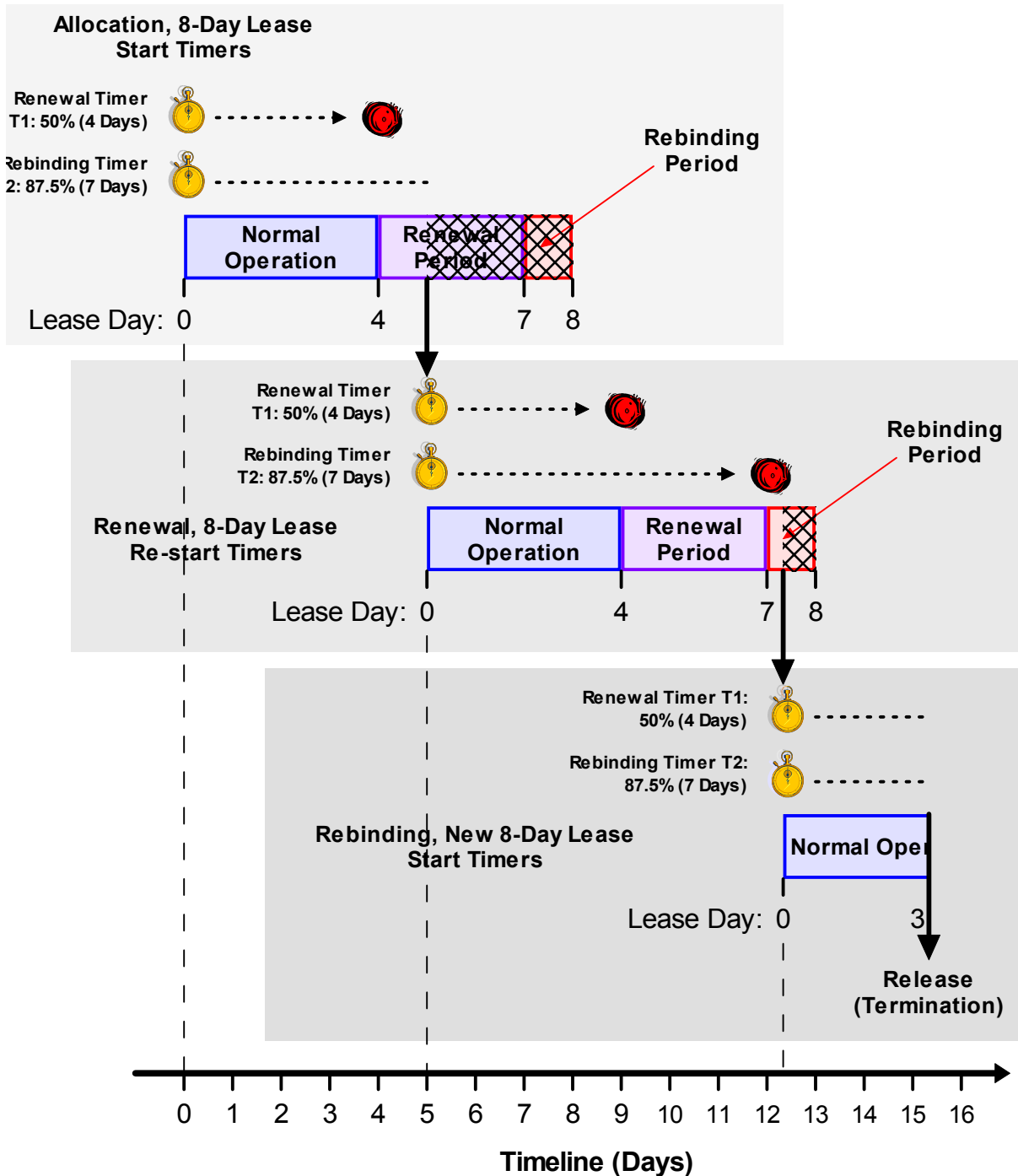

Figure 259: DHCP “Life Cycle” Example

In this example, the initial lease has a duration of eight days and begins at Day 0. The T1 and T2 timers are set for 4 days and 7 days respectively. When the T1 timer expires the client enters the renewal period, and successfully renews at Day 5 with a new 8-day lease. When this second lease’s T1 timer expires, the client is unable to renew with the original server. It enters the rebinding period when its T2 timer goes off, and is granted a renewed 8-day lease with a different server. Three days into this lease it is moved to a different network and no longer needs its leased address, so it voluntarily releases it.

The lease life cycle is described in the DHCP standards in the form of states that the client moves through as it acquires a lease, uses it, and then either renews or ends it. The next [section on DHCP configuration](#) describes these states and the specific exchanges of messages between a client and server to accomplish different lease activities.

DHCP Lease Address Pools, Ranges (Scopes) and Address Management

Simpler host configuration methods such as BOOTP (or DHCP manual allocation for that matter) associate a single IP address with each client machine. DHCP dynamic addressing removes this one-to-one correspondence, in favor of flexible address mapping to clients on an “as needed basis”. The clients no longer own the addresses but lease them from the true owner, the server. Obviously, then, a primary job of both a DHCP server and the administrator of that server is to maintain and manage these client addresses.

Address Pool Size Selection

The set of all addresses that a DHCP server has available for assignment is most often called the *address pool*. The first issue related to address management is ensuring that the address pool is large enough to serve all the clients that will be using the server. The number of addresses required depends on a number of factors:

- ☉ **Number Of Clients:** Obviously.
- ☉ **Stability and Frequency of Use Of Clients:** If most clients are left on and connected to the network all the time, you will probably need to plan on an address for each one. In contrast, if you are serving part-time employees, or consultants who frequently travel, you can get away with sharing a smaller number of addresses.
- ☉ **Consequences Of Over-Allocation:** If having certain clients be unable to get a free address is a problem, you need to more carefully manage the address pool to ensure that you don't run out. If having a client not get an address is *never* acceptable, make sure you have as many or more addresses as clients.

I'm sure you've probably noticed that these issues are similar to [those that I raised in discussing lease lengths](#) earlier in this section. In fact, the two matters are intimately related. Generally speaking, having more addresses gives the administrator the “luxury” of using longer leases. If you are short on addresses you probably need to use shorter leases to reduce the chances of any unused addresses continuing to be allocated to devices not needing them.

Lease Address Ranges (Scopes)

In its simplest form, the address pool takes the form of a list of all addresses that the DHCP server has reserved for dynamic client allocation. Along with each address, the server stores certain parameters, such as a default lease length for the address and other configuration information to be sent to the client when it is assigned that address (for example, a subnet mask and the address of a default router). All of this data is stored in a special database on the server.

Of course, many clients will request addresses from this pool. Most of these clients are “equals” as far as the DHCP server is concerned, and it doesn’t matter which address each individual client gets. This means most of the information stored with each of the addresses in a pool may be the same except for the address number itself. Due to this similarity, it would be inefficient to have to specify each address and its parameters individually. Instead, a *range* of addresses is normally handled as a single group defined for a particular network or subnet. These are not given any particular name in the DHCP standards, but are commonly called *scopes*. This term has been popularized by Microsoft in its DHCP server implementations. Other operating systems sometimes just call these blocks of addresses *ranges*, but I prefer “scope” so that is what I am using here.



Key Concept: Each DHCP server maintains a set of IP addresses that it uses to allocate leases to clients. These are usually contiguous blocks of addresses assigned to the server by an administrator, called DHCP *address ranges* or *scopes*.

Simple Address Assignment For a Single Scope

The exact method for setting up scopes depends on the particular operating system and DHCP server software, and I am not going to get into that here. However, each scope definition typically begins by specifying a range of addresses using a starting and an ending IP address. For example, if a company was assigned the IP address block 111.14.56.0/24, the administrator might set up a scope encompassing addresses 111.14.56.20 through 111.14.56.254, as shown in [Figure 260](#). Then for that scope, the administrator can set up various parameters to be specified to each client assigned an address from the scope.

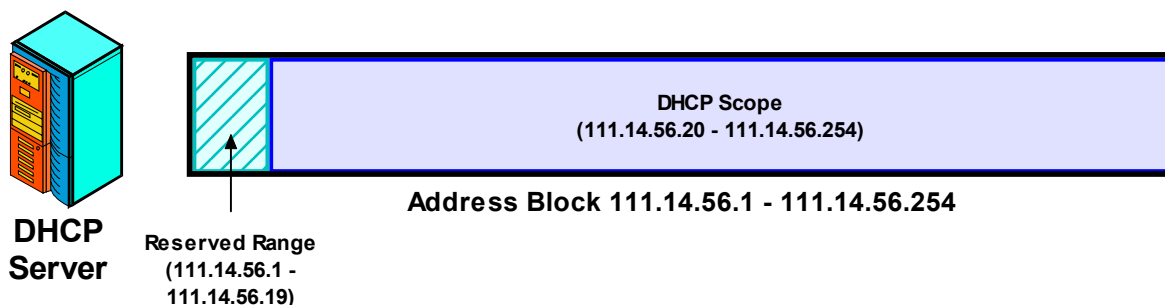

Figure 260: DHCP Scope

Why not start at 111.14.56.1? Usually we will want to set aside certain IP addresses for manual configuration of servers, routers and other devices requiring a fixed address. One easy way to do that is to simply reserve a block of addresses that aren’t used by DHCP. Alternately, most DHCP server software will allow you to specify a range but *exclude* an address or set of addresses from the range. So we could specify 111.14.56.1 through 111.14.56.254 and individually mark as “not available” addresses we manually assign. Or specify that 111.14.56.1 through 111.14.56.19 are reserved.

Address Assignment With Multiple Scopes

Instead of putting all of its addresses (except excluded ones) in a single scope, a server may use multiple scopes. One common reason for the latter approach is to support more than one subnet on a server. Multiple scopes are also commonly used when multiple DHCP servers are used to serve the same clients. There are two ways to do this: either by having *overlapping* or *non-overlapping* scopes.

Overlapping scopes allows each server to assign any address from the same pool. However, the DHCP standard doesn't specify any way for servers to communicate with each other when they assign an address, so if both servers were told they could assign addresses from the same address pool, this could result in both servers trying to assign a particular address to two different devices.

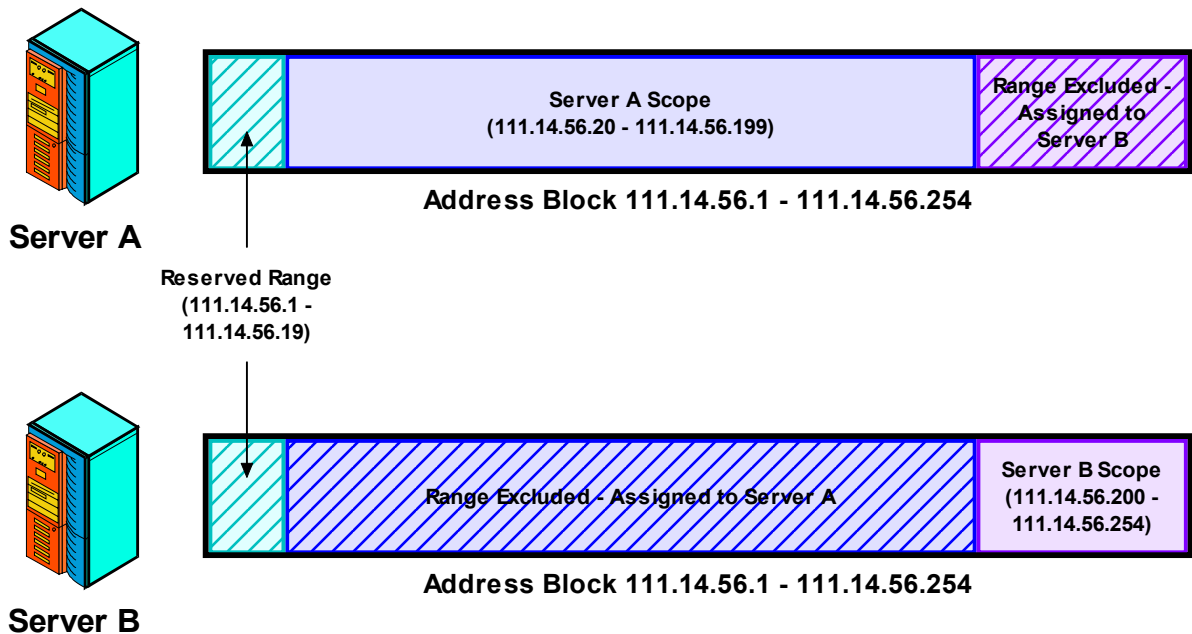

Figure 261: DHCP Multi-Server Non-Overlapping Scopes

DHCP servers *A* and *B* have been assigned non-overlapping scopes to ensure that they do not conflict. This has been done by starting with the same scope definition for both. The common reserved range is excluded from each. Then, server *A* has server *B*'s address range excluded (shaded purple at top) and *B* has *A*'s range excluded (shaded blue, bottom).

As a result, if you are using two DHCP servers (as is often recommended for redundancy reasons), the administrator generally gives them different, non-overlapping scope assignments. Alternately, the same scope is given to each server, with each server told to exclude from use the addresses the other server is assigning.

For example, suppose we have two DHCP servers: *A* (the main server) and *B* (the backup). We want to assign most of the addresses to *A* and a few as backup to *B*. We could give both *A* and *B* the scope 111.14.56.1 through 111.14.56.254. We'd exclude 111.14.56.1 through 111.14.56.19 from both. Then we'd exclude from server *A* the range 111.14.56.200

through 111.14.56.254, and exclude from server *B* the range 111.14.20 through 111.14.56.199. [Figure 261](#) shows how this would work. The main advantage of this method is that if one server goes down, the administrator can quickly remove the exclusion and let the remaining server access all addresses. Also, if one server runs out of addresses while the other has plenty, the allocations can be easily shifted.

Other Issues With Address Management

There are many other issues related to address management, which start to get into the “guts” of DHCP server implementation. For example, as was the case with BOOTP, we may need to use relay agents when the DHCP server is responsible for addresses on a subnet different from its own. There are also special DHCP features that affect how addresses are managed. For example, [the DHCP conflict detection feature](#) can actually allow two servers to have overlapping scopes, despite what we said above. [The section on DHCP implementation and features](#) gets into these issues in more detail.



Key Concept: If a site has multiple DHCP servers, they can be set up with either *overlapping* or *non-overlapping* scopes. Overlapping scopes allow each server to assign from the same pool, providing flexibility, but raising the possibility of two clients being assigned the same address unless a feature such as *server conflict detection* is employed. Non-overlapping scopes are “safer” because each server has a dedicated set of addresses for its use, but this means one server could run out of addresses while the other still has plenty, and if a server goes down its addresses will be temporarily unallocatable.



DHCP Configuration and Operation

The “big news” in DHCP is dynamic address allocation, and [the concept of address leasing](#). It is in fact this new functionality that makes DHCP significantly more complex than its predecessor. BOOTP is a simple request/reply protocol because a server only needs to look up a client's hardware address and send back the client's assigned IP address and other parameters. In contrast, DHCP clients and servers must do much more to carry out both parameter exchange and the many tasks needed to manage IP address leasing.

In this section I delve into the “nuts and bolts” of how DHCP operates. I begin with two background topics. The first provides an overview of the responsibilities of clients and servers in DHCP, and shows in general terms how they relate to each other. The second discusses DHCP configuration parameters and how they are stored and communicated.

The remaining five topics illustrate the operation of DHCP in detail. The first of the five describes the DHCP client *finite state machine*, which will give you a high-level look at the entire client lease “life cycle”, including address allocation, reallocation, renewal, rebinding and optionally, lease termination. This theoretical description is then used as the basis for several topics that explain the actual processes by which DHCP client lease activities occur. These show the specific actions taken by both client and server and when and how DHCP messages are created and sent. The last of the five topic describes the special mechanism by which a device not using DHCP for address allocation can request configuration parameters.



Note: If you are going to read this section, I strongly recommend reading the first three topics in sequence. Then, if you plan to read any of the following four “Process” topics, start with the first one on allocation, as it contains a number of important notes that apply also to the topics that follow it.

DHCP Overview of Client and Server Responsibilities

DHCP is the newest and most current TCP/IP host configuration protocol. However, as we saw in its [overview](#), it wasn't built “from scratch”—it was designed as an extension of the Boot Protocol. In many ways, DHCP is like “BOOTP with more”, and this can be seen in the basic setup of the protocol and how it works.

Both BOOTP and DHCP are designed based on [the common TCP/IP model of client/server operation](#). In any interaction, one device plays the role of client and the other server. Each has specific responsibilities and must send and receive messages following the protocol described in the DHCP standard. The difference is that where BOOTP involves relatively little work for servers and clients and uses a simple single-message exchange for communication, DHCP requires that both servers and clients do more, and uses several types of message exchanges.

DHCP Server Responsibilities

A DHCP server is a network device that has been programmed to provide DHCP services to clients. The server plays a central role in DHCP because DHCP's main function is host configuration, and the server is what configures hosts (clients) that communicate with it. On smaller networks there may be only a single server to support many clients, while larger networks may use multiple servers; regardless of the number of servers, each will usually service many clients.

The following are the key responsibilities of servers in making DHCP work:

- ① **Address Storage and Management:** DHCP servers are the owners of the addresses used by all DHCP clients. The server stores the addresses and manages their use, keeping track of which addresses have been allocated and which are still available.
- ② **Configuration Parameter Storage and Management:** DHCP servers also store and maintain other parameters that are intended to be sent to clients when requested. Many of these are important configuration values that specify in detail how a client is to operate.
- ③ **Lease Management:** As we saw in the previous section, DHCP servers use leases to dynamically allocate addresses to clients for a limited time. The DHCP server maintains information about each of the leases it has granted to clients, as well as policy information such as lease lengths.
- ④ **Responding To Client Requests:** DHCP servers respond to different types of requests from clients to implement the DHCP communication protocol. This includes assigning addresses, conveying configuration parameters and granting, renewing or terminating leases.
- ⑤ **Providing Administration Services:** To support all of the above, the DHCP server includes functionality to allow a human administrator to enter, view, change and analyze addresses, leases, parameters and all other information needed to run DHCP.

DHCP Client Responsibilities

A DHCP client is any device that sends DHCP requests to a server to obtain an IP address or other configuration information. Due to the advantages of DHCP, most host computers on TCP/IP internetworks today include DHCP client software, making them **potential** DHCP clients if their administrator chooses to enable the function. The main responsibilities of a DHCP client are:

- ① **Configuration Initiation:** The client takes the *active* role by initiating the communication exchange that results in it being given an IP address and other parameters. The server, in contrast, is *passive* and will not really do anything for the client until the client makes contact.
- ② **Configuration Parameter Management:** The client maintains parameters that pertain to its configuration, some or all of which may be obtained from a DHCP server.
- ③ **Lease Management:** Assuming its address is dynamically allocated, the client keeps track of the status of its own lease. It is responsible for renewing the lease at the appropriate time, rebinding if renewal is not possible, and terminating the lease early if the address is no longer needed.

-
- ☉ **Message Retransmission:** Since DHCP uses the unreliable [User Datagram Protocol](#) for messaging, clients are responsible for detecting message loss and retransmitting requests if need be.

DHCP Device Roles and Interaction

The DHCP server and client obviously play complementary roles. The server maintains configuration parameters for all clients; each client maintains its own parameters, as discussed in the next topic. IP address assignment and lease creation, renewal, rebinding and termination are accomplished through specific exchanges using a set of eight DHCP message types, which we will see later in this section. To accomplish this messaging, special rules are followed to generate, address and transport messages, which are [explained in a topic in the section on DHCP messaging](#).

Like BOOTP, DHCP also supports a third type of device, the *relay agent*. Relay agents are neither clients nor servers, but rather intermediaries that facilitate cross-network communication between servers and clients. They are described in more detail in [the section on DHCP implementation and features](#) (where you can also find more of the implementation details of servers and clients.)



Key Concept: *DHCP servers* are devices programmed to provide DHCP services to clients. They manage address information and other parameters and respond to client configuration requests. *DHCP clients* are TCP/IP devices that have been set to use DHCP to determine their configuration. They send requests and read responses, and are responsible for managing their own leases, including renewing or rebinding a lease when necessary.

DHCP Configuration Parameters, Storage and Communication

One of the more important oversights in DHCP's predecessor, BOOTP, is that the original protocol allowed a server to tell a client only three pieces of information: its IP address, the name of the server it could use to download a boot file, and the name of the boot file to use. This was a result of BOOTP's legacy as a protocol created primarily to let diskless workstations be bootstrapped.

Obviously, the IP address is a very important parameter, but in modern networks it isn't the only one that a client needs to be given for it to function properly. A typical host needs to be given other essential information to allow it to know how it should operate on its local network and interact with other devices. For example, it needs to know the address of a default local router, the subnet mask for the subnet it is on, parameters for creating outgoing IP datagrams, and much more.

Configuration Parameter Management

The inability to specify additional configuration parameters in BOOTP was resolved by using the special [BOOTP Vendor-Specific Area](#) for vendor-independent *vendor information fields*, as first defined in RFC 1048. In DHCP, this idea has been extended further, and more important, formalized, as part of the effort to make DHCP a more general-purpose configuration tool. Configuration parameter storage, maintenance and communication is no longer an optional feature, but an essential part of the host configuration process.

Just as DHCP servers are the “bosses” that own and manage IP addresses, they also act as the repository for other configuration parameters that belong to DHCP clients. This centralization of parameter storage provides many of the same benefits that centralizing IP addresses in DHCP does: parameters can be checked and adjusted in a single place rather than having to go to each client machine.

Each DHCP server is programmed with parameters that are to be communicated to clients in addition to an IP address when an address is assigned. Alternately, a client that has already been assigned an address using some other mechanism [may still query the DHCP server to get parameter information](#), using the *DHCPINFORM* message type. (This was actually added to the protocol in RFC 2131; it was not in the original DHCP standard.)

The exact method of storage of client parameters is to some extent implementation-dependent. Typically, there will be some parameters that apply to all clients. For example, on a small network with only one router, that router will probably be the default router for every DHCP client regardless of address.

Client-Specific Parameters and Client Identifiers

The DHCP server will also have certain parameters that are client-specific; the IP address itself is an obvious example, but there are other parameters that may apply to only certain clients on a network. These parameters are stored in some sort of a database, and indexed using a particular *client identifier*.

The default identifier consists of the client's IP subnet number and its hardware address. Thus, when a server gets a request from a particular subnet it can use the client's hardware address in the request to look up client-specific parameters and return them. The client identifier can be changed if a different identification scheme is desired.

Client Parameter Storage

Clients are also responsible for parameter storage, but of course, only their own parameters. Many of these will be obtained from the DHCP server, though some may be supplied in other ways. The specific implementation of the client determines which parameters it considers important and how they are discovered.

Configuration Parameter Communication

Communication of configuration parameters between DHCP clients and servers is accomplished using *DHCP options*, which replace BOOTP vendor information fields. A number of options were defined when DHCP was first created, and additional new ones have been created over the years. There are today several dozen of these options. Obviously, the ability to have so many different parameters automatically delivered to a client provides a great deal of host configuration flexibility to administrators. [DHCP options are described further in the section on DHCP message formats.](#)

DHCP General Operation and Client Finite State Machine

Dynamic address allocation is probably the most important new capability introduced by DHCP. In [the last section](#) I discussed in detail the significance of the change from IP address *ownership* to IP address *leasing*. I also provided a high-level look of the activities involved in leasing, by providing an overview of [the DHCP lease “life cycle”](#).

An overview of this sort is useful to get a general handle on how leases work, but to really understand the mechanics of DHCP address assignment and client/server communication, we need more detail on how the devices behave and what messages they send. One tool often employed by networking engineers to describe a protocol is a theoretical model called a *finite state machine (FSM)*. In this technique, the protocol's specific behavior is illustrated by showing the different *states* a device can be in, what possible *transitions* exist from one state to another, what *events* cause transitions to occur, and what *actions* are performed in response to an event. The [TCP operational overview](#) contains more general background information on finite state machines.

The DHCP standard uses an FSM to describe the lease life cycle from the perspective of a DHCP client. The client begins in an initial *INIT* state where it has no lease, and then transitions through various states as it acquires, renews, rebinds and/or releases its IP address. The FSM also indicates what message exchanges occurs between the server and client at various stages.

Some people think finite state machines are a little “dense” and hard to understand, and I can see why. You can skip this topic of course, but I think the FSM provides a useful way of illustrating in a comprehensive way most of the behavior of a DHCP client. [Table 189](#) describes each of the DHCP client states, and summarizes the messages sent and received by the client in each, as well as showing the state transitions that occur in

response. The FSM's states, events and transitions are easier to envision in [Figure 262](#), which also incorporates a color coding scheme so you can see which states are associated with each of the main DHCP processes.

Table 189: DHCP Client Finite State Machine (Page 1 of 3)

State	State Description	Event and Transition
INIT	This is the initialization state, where a client begins the process of acquiring a lease. It also returns here when a lease ends, or when a lease negotiation fails.	Client Sends <i>DHCPDISCOVER</i>: The client creates a <i>DHCPDISCOVER</i> message and broadcasts it to try to find a DHCP server. It transitions to the <i>SELECTING</i> state.
SELECTING	The client is waiting to receive <i>DHCPOFFER</i> messages from one or more DHCP servers, so it can choose one.	Client Receives Offers, Selects Preferred Offer, Sends <i>DHCPREQUEST</i>: The client chooses one of the offers it has been sent, and broadcasts a <i>DHCPREQUEST</i> message to tell DHCP servers what its choice was. It transitions to the <i>REQUESTING</i> state.
REQUESTING	The client is waiting to hear back from the server to which it sent its request.	Client Receives <i>DHCPACK</i>, Successfully Checks That IP Address Is Free: The client receives a <i>DHCPACK</i> message from its chosen server, confirming that it can have the lease that was offered. It checks to ensure that address is not already used, and assuming it is not, records the parameters the server sent it, sets the lease timers <i>T1</i> and <i>T2</i> , and transitions to the <i>BOUND</i> state.
		Client Receives <i>DHCPACK</i>, But IP Address Is In Use: The client receives a <i>DHCPACK</i> message from its chosen server, confirming that it can have the lease that was offered. However, it checks and finds the address already in use. It sends a <i>DHCPDECLINE</i> message back to the server, and returns to the <i>INIT</i> state.
		Client Receives <i>DHCPNAK</i>: The client receives a <i>DHCPNAK</i> message from its chosen server, which means the server has withdrawn its offer. The client returns to the <i>INIT</i> state.
INIT-REBOOT	When a client that already has a valid lease starts up after a power-down or reboot, it starts here instead of the <i>INIT</i> state.	Client Sends <i>DHCPREQUEST</i>: The client sends a <i>DHCPREQUEST</i> message to attempt to verify its lease and re-obtain its configuration parameters. It then transitions to the <i>REBOOTING</i> state to wait for a response.

Table 189: DHCP Client Finite State Machine (Page 2 of 3)

State	State Description	Event and Transition
REBOOTING	A client that has rebooted with an assigned address is waiting for a confirming reply from a server.	Client Receives DHCPACK, Successfully Checks That IP Address Is Free: The client receives a <i>DHCPACK</i> message from the server that has its lease information, confirming that the lease is still valid. To be safe, the client checks anyway to ensure that the address is not already in use by some other device. Assuming it is not, the client records the parameters the server sent it and transitions to the <i>BOUND</i> state.
		Client Receives DHCPACK, But IP Address Is In Use: The client receives a <i>DHCPACK</i> message from the server that had its lease, confirming that the lease is still valid. However, the client checks and finds that while the client was offline, some other device has grabbed its leased IP address. The client sends a <i>DHCPDECLINE</i> message back to the server, and returns to the <i>INIT</i> state to obtain a new lease.
		Client Receives DHCPNAK: The client receives a <i>DHCPNAK</i> message from a server. This tells it that its current lease is no longer valid; for example, the client may have moved to a new network where it can no longer use the address in its present lease. The client returns to the <i>INIT</i> state.
BOUND	Client has a valid lease and is in its normal operating state.	Renewal Timer (T1) Expires: The client transitions to the <i>RENEWING</i> state.
		Client Terminates Lease, Sends DHCPRELEASE: The client decides to terminate the lease (due to user command, for example.) It sends a <i>DHCPRELEASE</i> message and returns to the <i>INIT</i> state.
RENEWING	Client is trying to renew its lease. It regularly sends <i>DHCPREQUEST</i> messages with the server that gave it its current lease specified, and waits for a reply.	Client Receives DHCPACK: The client receives a <i>DHCPACK</i> reply to its <i>DHCPREQUEST</i> . Its lease is renewed, it restarts the <i>T1</i> and <i>T2</i> timers, and returns to the <i>BOUND</i> state.
		Client Receives DHCPNAK: The server has refused to renew the client's lease. The client goes to the <i>INIT</i> state to get a new lease.
		Rebinding Timer (T2) Expires: While attempting to renew its lease, the <i>T2</i> timer expires, indicating that the renewal period has ended. The client transitions to the <i>REBINDING</i> state.

Table 189: DHCP Client Finite State Machine (Page 3 of 3)

State	State Description	Event and Transition
REBINDING	The client has failed to renew its lease with the server that originally granted it, and now seeks a lease extension with any server that can hear it. It periodically sends <i>DHCPREQUEST</i> messages with no server specified until it gets a reply or the lease ends.	Client Receives <i>DHCPACK</i>: Some server on the network has renewed the client's lease. The client binds to the new server granting the lease, restarts the <i>T1</i> and <i>T2</i> timers, and returns to the <i>BOUND</i> state.
		Client Receives <i>DHCPNAK</i>: A server on the network is specifically telling the client it needs to restart the leasing process. This may be the case if a new server is willing to grant the client a lease, but only with terms different than the client's current lease. The client goes to the <i>INIT</i> state.
		Lease Expires: The client receives no reply prior to the expiration of the lease. It goes back to the <i>INIT</i> state.

This is just a summary of the finite state machine, and does not show every possible event and transition, since it is complex enough already. For example, if a client that received two offers in the *SELECTING* state receives a *DHCPNAK* from its chosen server in the *REQUESTING* state, it may choose to send a new *DHCPREQUEST* to its "second choice" instead of starting over from scratch. Also, the client must have logic that lets it "time out" if it receives no reply to sent messages in various states, such as not receiving any offers in the *SELECTING* state. The next few topics discuss these matters in more detail.

Note also that the DHCP standard does not describe the DHCP **server's** behavior in the form of a finite state machine, only the client's. Here too, there is more information on what exactly DHCP servers do in the pages that follow.

I should also point out explicitly that this finite state machine applies to dynamically-allocated clients; that is, ones with conventional leases. A device configured using "automatic" allocation will go through the same basic allocation process, but does not need to renew its lease. The process for manual allocation is somewhat different.

DHCP Lease Allocation Process

To implement DHCP, an administrator must first set up a DHCP server and provide it with configuration parameters and policy information: IP address ranges, lease length specifications, and configuration data that DHCP hosts will need to be delivered to them. Host devices can then have their DHCP client software enabled, but nothing will happen until the client initiates communication with the server. When a DHCP client starts up for the first time, or when it has no current DHCP lease, it will be in an initial state where it doesn't have an address and needs to acquire one. It will do so by initiating the process of *lease allocation*.

Notes on Lease Communication Descriptions

Before I begin, some notes about this description, which also apply to subsequent topics in this section on DHCP lease communications:

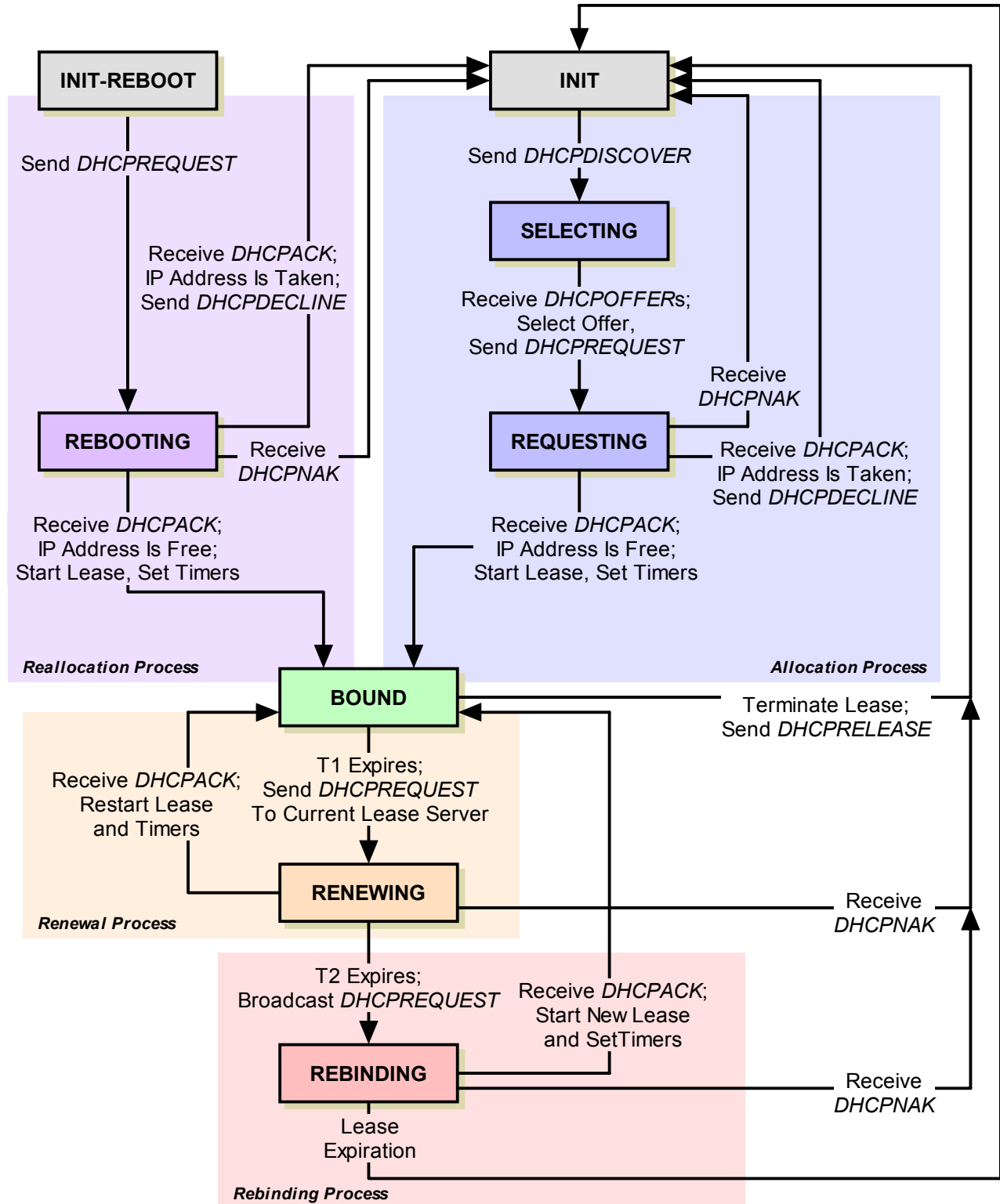

Figure 262: DHCP Client Finite State Machine

This diagram shows the finite state machine used by DHCP clients. The colored background areas show the transitions taken by a DHCP client as it moves through the four primary DHCP processes: allocation, reallocation, renewal and rebinding.

-
- ④ **Addressing:** DHCP assumes that clients will normally broadcast messages, since they don't know the address of servers when they initiate contact, but that servers will send replies back unicast to the client. This can be done even before the client has an IP address, by sending the message at the link layer. Some clients don't support this and require that messages to them be broadcast instead. The details of how messages are created and addressed are discussed in [the section on DHCP messaging](#).
 - ④ **DHCP Message Fields and Options:** DHCP uses many of the same basic fields as BOOTP, but much of the extra information the protocol requires is carried in DHCP *options*. Obviously, some of these “options” aren't really optional, despite the name—they are needed for the basic function of DHCP. An obvious example would be the *DHCP Message Type* option, which is what specifies the message type itself. Again, you can find a full description of all DHCP fields and options in [the section on DHCP messaging](#).
 - ④ **DHCP Relay Agents:** I have assumed that no relay agents are in use here; see [the topic on DHCP/BOOTP relay agents](#) for more on how they change the allocation process (and other processes).

Lease Allocation Process Steps

Below I have described the steps that are followed by a DHCP client and server in the initial allocation of an IP address lease. This is a basic description, and I have not included all the details of what the client and server do, as that would make this description incredibly long. Instead, I have focused on the most important tasks each device performs, and also specified the message types exchanged and critical pieces of data included in each message, as well as client states and transitions. The process is also illustrated in [Figure 263](#).

1. Client Creates *DHCPDISCOVER* Message

The client begins in the *INIT (initialization)* state. It has no IP address and doesn't even know whether or where a DHCP server may be on the network. To find one, it creates a *DHCPDISCOVER* message, including the following information:

- ④ Its own hardware address in the *CHAddr* field of the message, to identify itself.
- ④ A random transaction identifier, put into the *XID* field. This is used to identify later messages as being part of the same transaction.
- ④ Optionally, the client may request a particular IP address using a *Requested IP Address* DHCP option, a particular lease length using an *IP Address Lease Time* option, and/or specific configuration parameters by including a *Parameter Request List* option in the message.

2. Client Sends *DHCPDISCOVER* Message

The client broadcasts the *DHCPDISCOVER* message on the local network. The client transitions to the *SELECTING* state, where it waits for replies to its message.

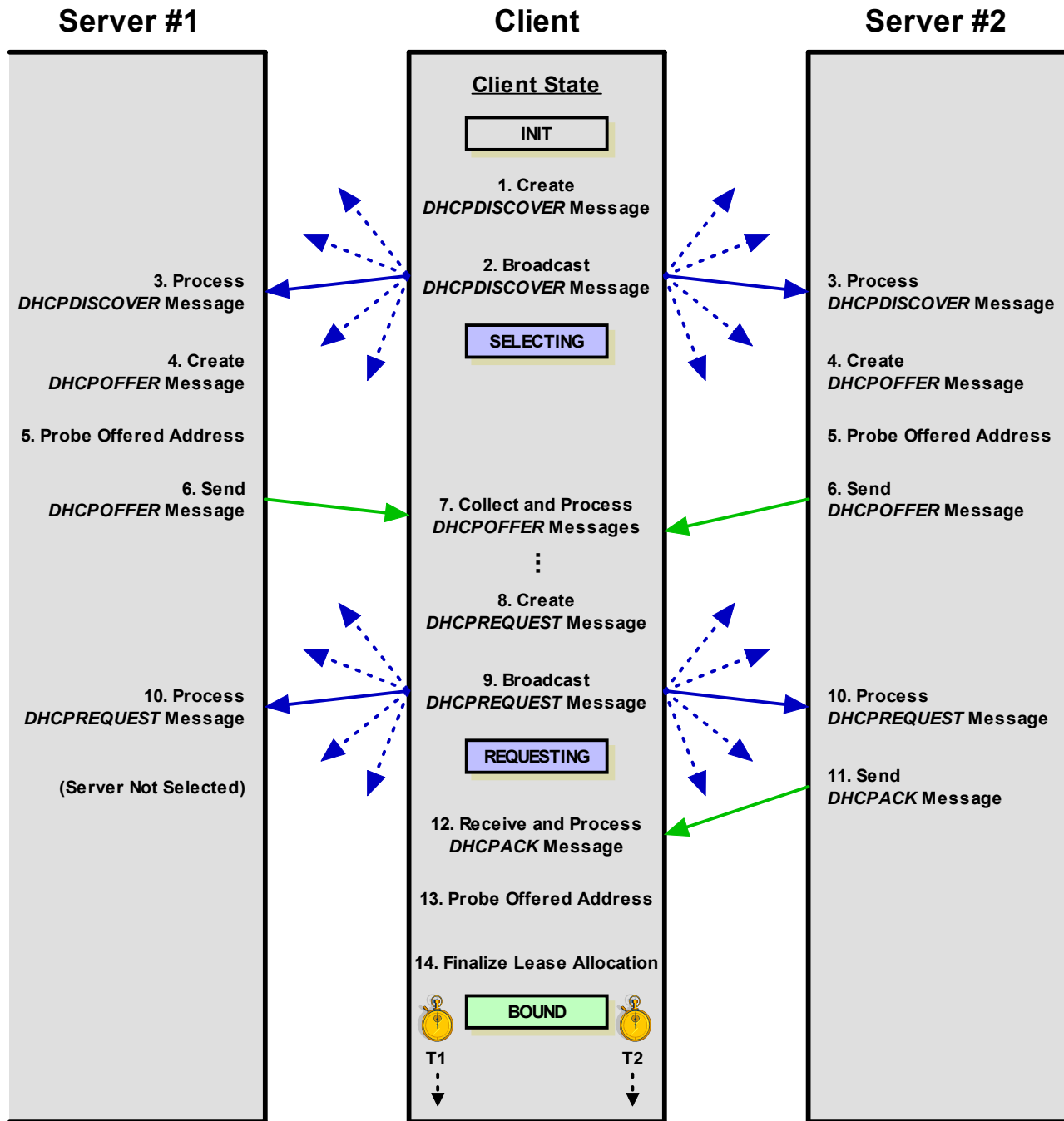

Figure 263: DHCP Lease Allocation Process

This diagram shows the steps involved in DHCP client lease allocation. This diagram is a bit different from most of the other client/server exchange diagrams in this Guide in that I have shown two servers instead of one. This shows how a client handles responses from multiple DHCP servers and how each servers react differently depending on whether or not its lease offer was chosen by the client.

3. Servers Receive and Process *DHCPDISCOVER* Message

Each DHCP server on the local network receives the client's *DHCPDISCOVER* message and examines it. The server looks up the client's hardware address in its database and determines if it is able to offer the client a lease, and what the terms of the lease will be. If the client has made requests for a particular IP address, lease length, or other parameters, the server will attempt to satisfy these requests, but is not required to do so. A server may decide not to offer a lease to a particular client if it has not been programmed to provide service for it, it has no remaining IP addresses or for other reasons.

4. Servers Create *DHCPOFFER* Messages

Each server that chooses to respond to the client creates a *DHCPOFFER* message including the following information:

- ☉ The IP address to be assigned to the client, in the *YIAddr* field. If the server previously had a lease for this client it will attempt to reuse the IP address it used last time. Failing that, it will try to use the client's requested address if present; otherwise, it will select any available address.
- ☉ The length of the lease being offered.
- ☉ Any client-specific configuration parameters either requested by the client or programmed into the server to be returned to the client.
- ☉ Any general configuration parameters to be returned to all clients or clients in this client's class.
- ☉ The server's identifier in the DHCP *Server Identifier* option.
- ☉ The same transaction ID (*XID*) used in the *DHCPDISCOVER* message.

5. Servers Probe And/Or Reserve Offered Address (Optional)

The DHCP standard specifies that before sending a *DHCPOFFER* to a client, the server “SHOULD” check to see that the IP address isn't already in use by sending an [ICMP Echo message](#) to that address. If the probe is made and the address is in use, the server will of course not offer it to the client. This may be disabled by an administrator. It is considered a key part of the [DHCP server conflict detection feature](#).

Whether or not it probes the address offered, the server may also *reserve* the address so that if the client decides to use it, it will be available. This isn't mandatory, because as we'll see below, the protocol handles the case where an offered lease is retracted. It is more efficient if servers do reserve addresses, but if IP addresses are in very short supply, such reservation may not be practical.

6. Servers Send *DHCPOFFER* Messages

Each server sends its *DHCPOFFER* message. They of course may not all be sent at exactly the same time. The messages are sent either unicast or broadcast, as mentioned earlier.

7. Client Collects and Processes *DHCPOFFER* Messages

The client waits for *DHCPOFFER* messages to arrive in response to its *DHCPDISCOVER*. The exact behavior of the client here is implementation-dependent. The client may decide to simply take the first offer it receives, for expediency. Alternately, it may choose to “shop around” by waiting for a period of time. It can then process each offer and take the one with the most favorable terms—for example, the one with the longest lease.

If no *DHCPOFFER* messages are received, the client will enter a retransmission mode and try sending the *DHCPDISCOVER* again for a period of time.

8. Client Creates *DHCPREQUEST* Message

The client creates a *DHCPREQUEST* message for the server offer it has selected. This message serves two purposes: it tells the server whose offer the client has accepted “yes, I accept your offer, assuming it is still available” and also tells the other servers “sorry, your offer was rejected”. (Well, except for the “sorry” part; servers are pretty thick-skinned about rejection. ☺) In this message, the client includes the following information:

- ☉ The identifier of the “chosen” server in the *DHCP Server Identifier* option, so everyone knows “who won”.
- ☉ The IP address that the DHCP server assigned the client in the *DHCPOFFER* message, which the client puts in the *Requested IP Address* DHCP option as a confirmation.
- ☉ Any additional configuration parameters it wants in a *Parameter Request List* option in the message.

9. Client Sends *DHCPREQUEST* Message

The client sends the *DHCPREQUEST* message. Since it is intended for not just the selected DHCP server but all servers, it is broadcast. After doing this, the client transitions to the *REQUESTING* state, where it waits for a reply from the chosen server.

10. Servers Receive and Process *DHCPREQUEST* Message

Each of the servers receives and processes the client's request message. The servers not chosen will take the message as a rejection. However, note that a client may select one offer, attempt to request the lease and have the transaction not complete successfully. The client may then come back and try its “second choice” offer by sending a *DHCPREQUEST* containing a different *Server Identifier*. This means that if Server *A* receives a single *DHCPREQUEST* with a *Server Identifier* of Server *B*, that doesn't necessarily mean that Server *A* is done with the transaction. For this reason, “rejected” servers will wait for a while before offering a previously-offered lease to another client.

11. Server Sends *DHCPACK* or *DHCPNAK* Message

The chosen server will see that its lease has been selected. If it did not previously reserve the IP address that was offered to the client, it must check to make sure it is still available. If it is not, the server sends back a *DHCPNAK* (*negative acknowledgment*) message, which

essentially means “never mind, that lease is no longer available”. Usually, however, the server will still have that lease. It will create a *binding* for that client, and send back a *DHCPACK* (*acknowledgment*) message that confirms the lease and contains all the pertinent configuration parameters for the client.

12. Client Receives and Processes *DHCPACK* or *DHCPNAK* Message

The client receives either a positive or negative acknowledgment for its request. If the message is a *DHCPNAK*, the client transitions back to the *INIT* state and starts over: back to square one (step #1). If it is a *DHCPACK*, the client reads the IP address from the *YIAddr* field, and records the lease length and other parameters from the various message fields and DHCP options.

If the client receives neither message, it may retransmit the *DHCPREQUEST* message one or more times. If it continues to hear nothing then it must conclude that the server flaked out and go back to step #1.

13. Client Checks That Address Is Not In Use

The client device should perform a final check to ensure that the new address isn't already in use before it concludes the leasing process. This is typically done by generating an [Address Resolution Protocol \(ARP\)](#) request on the local network, to see if any other device thinks it already has the IP address this client was just leased. If another device responds, the client sends a *DHCPDECLINE* message back to the server, which basically means “hey server, you screwed up, someone's already using that address”. The client then, you guessed it, goes back to step #1 and starts over.

14. Client Finalizes Lease Allocation

Assuming that the address is not already in use, the client finalizes the lease and transitions to the *BOUND* state. It also sets its two lease timers, *T1* and *T2*. It is now ready for normal operation.

Dealing With Lost Messages or Failure of the Allocation Process

You can see in this description that there are a number of situations that may occur that require a client to retransmit messages. This is because [DHCP uses UDP](#) which is unreliable and can cause messages to be lost. If retransmissions don't fix a problem such as not receiving a *DHCPOFFER* or a *DHCPACK* from a server, the client may have to start the allocation process over from scratch. The client must include enough “intelligence” to prevent it from simply trying forever to get a lease when there may not be a point—for example, if there are no DHCP servers on the network, no number of retransmissions will help.

Thus, after a number of retries the client will give up and the allocation process will fail. If the client is configured to use the [Automatic Private IP Addressing](#) feature, this is where it would be used to give the client a default address. Otherwise, the client will be, well, “dead in the water”.



Key Concept: The most important configuration process in DHCP is the *lease allocation process*, used by clients to acquire a lease. The client broadcasts a request to determine if any DHCP servers can hear it. Each DHCP server that is willing to grant the client a lease sends it an offer. The client selects the lease it prefers and sends a response to all servers telling them its choice. The selected server then sends the client its lease information.

DHCP Lease Reallocation Process

When a DHCP client starts up for the first time and has no lease, it begins in the *INIT* (*initialize*) state and goes through [the allocation process described in the preceding topic](#) to acquire a lease. The same process is used when a lease ends, if a lease renewal fails, or some error or other happening causes a client to need a new lease.

Situations Where Reallocation Is Performed

There are certain situations in which a client starts up while it still has a lease already in place. In this situation, the client does not need to go through the entire process of getting an IP address allocation and a new lease setup. Instead, it simply tries to re-establish its existing lease, through a process that I call *reallocation*.

There are two primary circumstances under which a client performs reallocation rather than allocation:

- ☉ **Power On With Existing Lease:** The length of time that a client lease lasts can range from minutes to years; it is entirely a matter of the [lease length policy](#) set for the network and client by the administrator. Many, if not most client machines are not left connected to the network 24 hours a day; they are turned on during the day and then shut down at night, and also shut down on weekends. A client with a very short lease that is shut down and then later started again will probably find that its lease has expired, and will have to get a new one. However, if a lease is longer than a few days, it will still probably be in effect when the client starts up again.
- ☉ **Reboot:** Clients are also sometimes rebooted, to install new software or correct a problem. In this case even when the lease length is very short, the restarting client will still have a valid lease when it starts up.

Lease Reallocation Process Steps

The reallocation process is essentially an abbreviated version of the allocation process described in the previous topic. There is no need for the client to go through the whole “yoo-hoo, any servers out there want to give me a lease” routine. Instead, the client attempts to find the server that gave it the lease in the first place, seeking a confirmation that the lease is still valid and that it may resume using its previously-allocated IP address. It also receives confirmation of the parameters it should use.

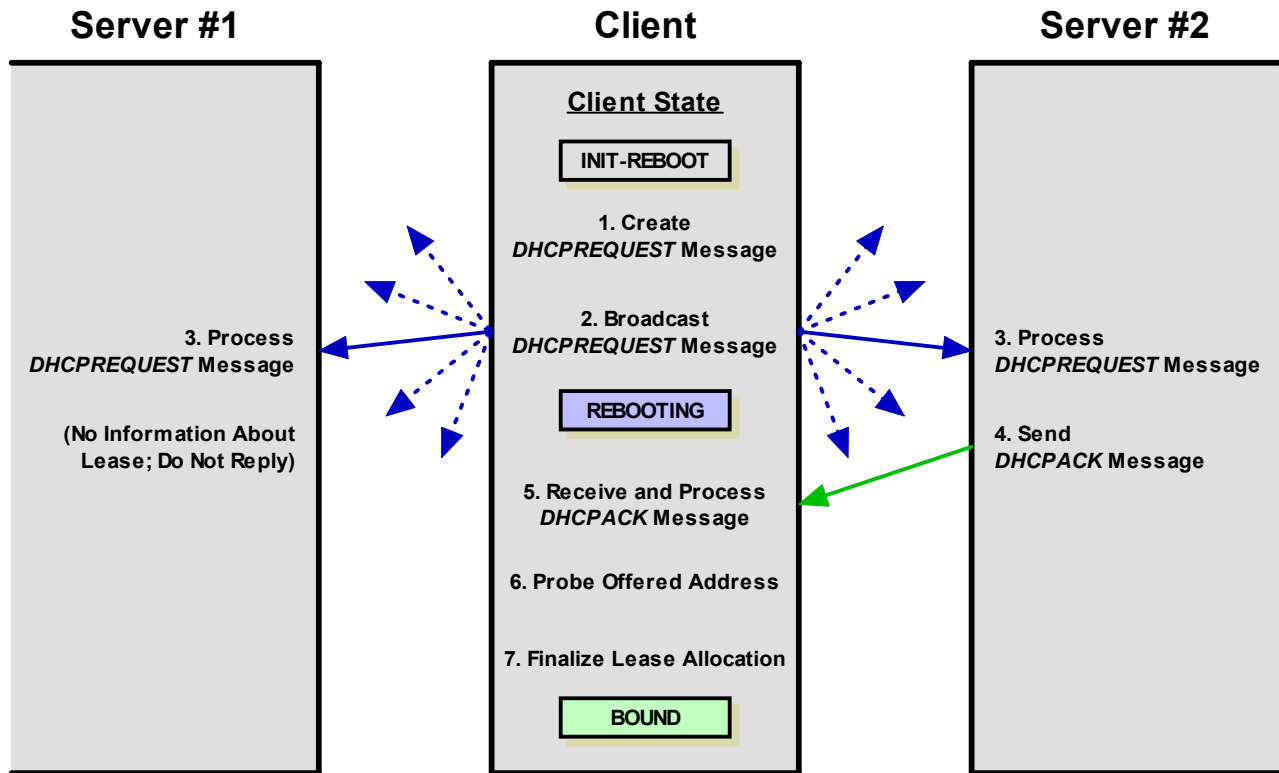

Figure 264: DHCP Lease Reallocation Process

The lease reallocation process consists of seven steps that correspond approximately to steps 8 through 14 of the full lease allocation process shown in [Figure 263](#). In this example, the server that originally granted the lease to the client is Server #2, so it is normally the only one that responds.

The following steps summarize the reallocation process, which is also shown in [Figure 264](#). (Note that the same notes about addressing fields, relay agents and such that I mentioned in [the discussion of lease allocation](#) apply here as well):

1. Client Creates *DHCPREQUEST* Message

The client begins in the *INIT-REBOOT* state instead of the *INIT* state. It creates a *DHCPREQUEST* message to attempt to find a server with information about its current lease. Note that this may or may not be the server that originally granted the lease; the server responsible for a lease could, theoretically, have changed in the time since the client obtained the lease. Thus, unlike the *DHCPREQUEST* message in step #8 in the allocation process, the client does **not** include a *DHCP Server Identifier* option. It does include the following information:

- ☉ Its own hardware address in the *CHAddr* field of the message, to identify itself.
- ☉ The IP address of its existing lease, in the *Requested IP Address* DHCP option. Note that this address is **not** put into the *CIAddr* field.
- ☉ A random transaction identifier, put into the *XID* field. This is used to identify later messages as being part of the same transaction.

-
- ④ Any additional configuration parameters it wants, in a *Parameter Request List* option in the message.

2. Client Sends *DHCPREQUEST* Message

The client broadcasts the *DHCPREQUEST* message. It then transitions to the *REBOOTING* state, where it waits for a reply from a server.

3. Servers Receive and Process *DHCPREQUEST* Message and Generate Replies

Each server on the network receives and processes the client's request. The server looks up the client in its database, attempting to find information about the lease. Each server then decides how to reply to the client:

- ④ **Server Has Valid Client Lease Information:** The server has information about the client's lease. It sends a *DHCPACK* message to confirm the lease. It will also reiterate any parameters the client should be using.
- ④ **Server Determines Client Lease Is Invalid:** The server determines that the client's lease is no longer valid. Common reasons for this happening are the client trying to confirm a lease after it has moved to a different network, or after the lease has in fact already expired. In such a case the server sends a *DHCPNAK* message to negate the lease request.
- ④ **Server Has No Definitive Information About Client Lease:** A server that has no information about the lease does not respond. A server is also required not to respond unless its information is guaranteed to be accurate. So, for example, if a server has knowledge of an old expired lease, it cannot assume that the lease is no longer valid and send a *DHCPNAK*, unless it also has certain knowledge that no other server has a newer, valid lease for that client.

4. Servers Send Replies

Servers that are going to respond to the client's *DHCPREQUEST* send their *DHCPACK* or *DHCPNAK* messages.

5. Client Receives and Processes *DHCPACK* or *DHCPNAK* Message

The client waits for a period of time to get a reply to its request. Again, there are three possibilities that match the three in the previous step:

- ④ **Positive Acknowledgment:** The client receives a *DHCPACK* message; this confirms the validity of the lease. The client will prepare to begin using the lease again, and continue with the next step below.
- ④ **Negative Acknowledgment:** The message is a *DHCPNAK*, which tells the client that its lease is no longer valid. The client transitions back to the *INIT* state to get a new lease—step #1 in the allocation process.
- ④ **No Reply:** If the client receives no reply at all, it may retransmit the *DHCPREQUEST* message. If no reply is received after a period of time, it will conclude that no server has information about its lease and will return to the *INIT* state to try to get a new lease.

6. Client Checks That Address Is Not In Use

Before resuming use of its lease, the client device should perform a final check to ensure that the new address isn't already in use. Even though this should not be the case when a lease already exists, it's done anyway, as a "safety measure" of sorts. The check is the same as described in step #13 of the allocation process: an ARP request is issued on the local network, to see if any other device thinks it already has the IP address this client was just leased. If another device responds, the client sends a *DHCPDECLINE* message back to the server, which tells it that the lease is no good because some other device is using the address. The client then goes back to the *INIT* state to get a new lease.

7. Client Finalizes Lease Allocation

Assuming that the address is not already in use, the client finalizes the lease and transitions to the *BOUND* state. It is now ready for normal operation.



Key Concept: If a client starts up and already has a lease, it need not go through the full lease allocation process; instead, it can use the shorter *reallocation process*. The client broadcasts a request to find the server that has the current information on its lease; that server responds back to confirm that the client's lease is still valid.

DHCP Lease Renewal and Rebinding Processes

Once a DHCP client completes the allocation or reallocation process, it enters the *BOUND* state. The client is now in its regular operating mode, with a valid IP address and other configuration parameters it received from the DHCP server, and can be used like any regular TCP/IP host.

While the client is in the *BOUND* state, DHCP essentially lies dormant. As long as the client stays on and functioning normally, no real DHCP activity will occur while in this state. The most common occurrence that causes DHCP to "wake up" and come active again is arrival of the time when the lease is to be *renewed*. Renewal ensures that a lease is perpetuated so it can be used for a prolonged period of time, and involves its own message exchange procedure. (The other way that a client can leave the *BOUND* state is when it [terminates the lease early](#).)

If DHCP's [automatic allocation](#) is used, or if [dynamic allocation](#) is used with an infinite lease period, the client's lease will never expire, so it never needs to be renewed. Short of early termination, the device will remain in the *BOUND* state forever, or at least until it is rebooted. However, as we've already discussed, most leases are finite in nature. A client must take action to ensure that its lease is extended and normal operation continues.

To manage the lease extension process, two timers are set at the time that a lease is allocated. The *renewal timer (T1)* goes off to tell the client it is time to try to renew the lease with the server that initially granted it. The *rebinding timer (T2)* goes off if the client is not

successful in renewing with that server, and tells it to try any server to have the lease extended. If the lease is renewed or rebound, the client goes back to normal operation. If it cannot be rebound, it will expire and the client will need to seek a new lease.

Lease Renewal/Rebinding Process Steps

The following steps summarize the renewal/rebinding process. Obviously, the exact sequence of operations taken by a client depends on what happens in its attempts to contact a server; for example, if it is successful with renewal, it will never need to attempt rebinding. An example renewal and rebinding is illustrated in [Figure 265](#). Note also that the same notes about addressing fields, relay agents and such that I mentioned in [the allocation process topic](#) apply here as well.

1. Renewal Timer (*T1*) Expires

The renewal timer, *T1*, is set by default to 50% of the length of the lease. When the timer goes off, the client transitions from the *BOUND* state to the *RENEWING* state.

Note that a client *may* initiate lease renewal prior to *T1* timer expiration if it desires.

2. Client Sends *DHCPREQUEST* Renewal Message

The client creates a *DHCPREQUEST* message that identifies itself and its lease. It then transmits the message directly to the server that initially granted the lease, unicast. Note that this is different from the *DHCPREQUEST* messages used in the allocation/reallocation processes, where the *DHCPREQUEST* is broadcast. The client may request a particular new lease length, just as it may request a lease length in its requests during allocation, but as always, the server makes the final call on lease length.

3. Server Receives and Processes *DHCPREQUEST* Message and Creates Reply

Assuming the server is reachable, it will receive and process the client's renewal request. There are two possible responses:

- ① **Server Agrees To Renew Client Lease:** The server decides that the client's lease can be renewed. It prepares to send to the client a *DHCPACK* message to confirm the lease's renewal, indicating the new lease length and any parameters that may have changed since the lease was created or last renewed.
- ② **Server Refuses To Renew Client Lease:** The server decides for whatever reason not to renew the client's lease. It will create a *DHCPNAK* message.

4. Server Sends Reply

The server sends the *DHCPACK* or *DHCPNAK* message back to the client.

5. Client Receives and Processes Server Reply

The client takes the appropriate action in response to the server's reply:

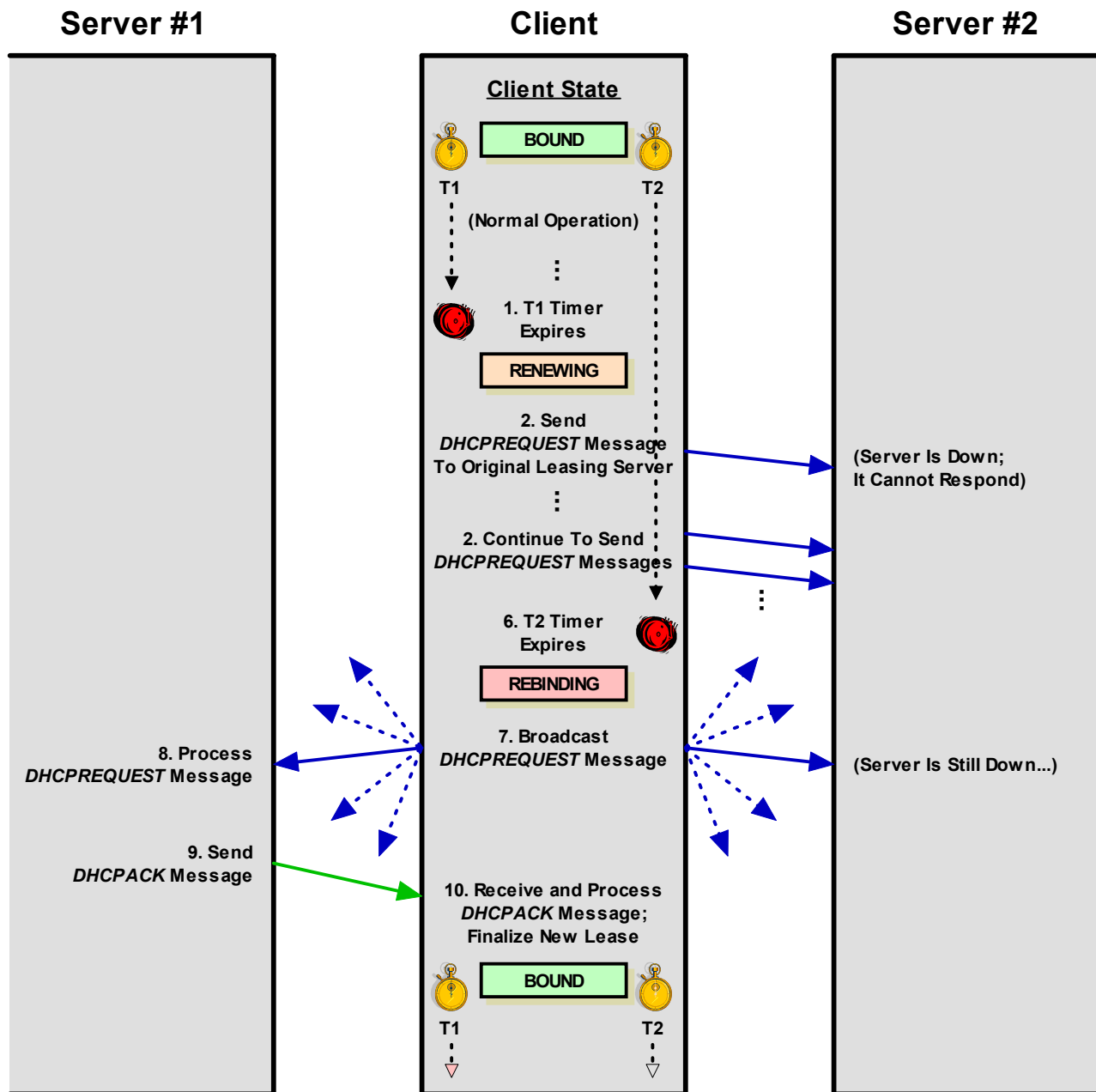

Figure 265: DHCP Lease Renewal and Rebinding Processes

This diagram shows the example of a client that presently holding a lease with Server #2 attempting to contact it to renew the lease. However, in this case, Server #2 is down for maintenance. The server is unable to respond and the client remains stuck at Step #2 in the renewal/rebinding process. It keeps sending *DHCPREQUEST* messages to Server #2 until its T2 timer expires. It then enters the rebinding state and broadcasts a *DHCPREQUEST* message, which is heard by Server #1, which in this case agrees to extend its current lease.

- 🕒 **Positive Acknowledgment:** The client receives a *DHCPACK* message, renewing the lease. The client makes note of the new lease expiration time and any changed parameters sent by the server, resets the T1 and T2 timers, and transitions back to the *BOUND* state. Note that the client does *not* need to do an ARP IP address check when it is renewing.

-
- ④ **Negative Acknowledgment:** The message is a *DHCPNAK*, which tells the client that its lease renewal request has been denied. The client will immediately transition to the *INIT* state to get a new lease—step #1 in the allocation process.

6. Rebinding Timer (*T2*) Expires

If the client receives no reply from the server, it will remain in the *RENEWING* state, and will regularly retransmit the unicast *DHCPREQUEST* to the server. During this period of time, the client is still operating normally, from the perspective of its user. If no response from the server is received, eventually the rebinding timer (*T2*) expires. This will cause the client to transition to the *REBINDING* state. Recall that by default, the *T2* timer is set to 87.5% (7/8ths) of the length of the lease.

7. Client Sends *DHCPREQUEST* Rebinding Message

Having received no response from the server that initially granted the lease, the client “gives up” on that server and tries to contact any server that may be able to extend its existing lease. It creates a *DHCPREQUEST* message and puts its IP address in the *CIAddr* field, indicating clearly that it presently owns that address. It then broadcasts the request on the local network.

8. Servers Receives and Processes *DHCPREQUEST* Message and Send Reply

Each server receives the request, and responds according to the information it has for the client (a server that has no information about the lease or may have outdated information does not respond):

- ④ **Server Agrees To Rebind Client Lease:** A server has information about the client's lease and agrees to extend it. It prepares for the client a *DHCPACK* message to confirm the lease's renewal, indicating any parameters that may have changed since the lease was created or last renewed.
- ④ **Server Decides Client Cannot Extend Its Current Lease:** A server determines that for whatever reason, this client's lease should not be extended. It gets ready to send back to the client a *DHCPNAK* message.

9. Server Sends Reply

Each server that is responding to the client sends its *DHCPACK* or *DHCPNAK* message.

10. Client Receives Server Reply

The client takes the appropriate action in response to the two possibilities in the preceding step:

- ④ **Positive Acknowledgment:** The client receives a *DHCPACK* message, rebinding the lease. The client makes note of the server that is now in charge of this lease, the new lease expiration time, and any changed parameters sent by the server. It resets the *T1* and *T2* timers, and transitions back to the *BOUND* state. (It may also probe the new address as it does during regular lease allocation.)

-
- 🕒 **Negative Acknowledgment:** The message is a *DHCPNAK*, which tells the client that some server has determined that the lease should not be extended. The client immediately transitions to the *INIT* state to get a new lease—step #1 in the [allocation process](#).

11. Lease Expires

If the client receives no response to its broadcast rebinding request, it will, as in the *RENEWING* state, retransmit the request regularly. If no response is received by the time the lease expires, it transitions to the *INIT* state to get a new lease.

The Purpose of the Two-Step Rebinding/Renewal Process

One valid question is: why bother with a two-step process, rebinding and renewal? The reason is that this provides the best blend of efficiency and flexibility. We first try to contact the server that granted the lease using a unicast request, to avoid taking up the time of other DHCP servers and disrupting the network as a whole with broadcast traffic. Usually this will work, because DHCP servers don't change that often and are usually left on continuously. If that fails, we then fall back on the broadcast, giving other servers a chance to take over the client's existing lease.



Key Concept: Each client's lease has associated with it a *renewal timer (T1)*, normally set to 50% of the length of the lease, and a *rebinding timer (T2)*, usually 87.5% of the lease length. When the *T1* timer goes off the client will try to renew its lease by contacting the server that originally granted it. If the client cannot renew the lease by the time the *T2* timer expires, it will broadcast a rebinding request to any available server. If the lease is not renewed or rebound by the time the lease expires, the client must start the lease allocation process over again.

DHCP Early Lease Termination (Release) Process

A TCP/IP host can't really do much without an IP address; it's a fundamental component of the Internet Protocol, upon which all TCP/IP protocols and applications run. When a host has either a manual IP address assignment or an "infinite" lease, it obviously never has to worry about losing its IP address. When a host has a finite DHCP lease, it will use the [renewal/rebinding process](#) to try to "hang on" to its existing IP address as long as possible.

So, under normal circumstances, a client will continue trying to extend its existing lease indefinitely. In certain cases, however, a host may decide to terminate its lease. This usually will not be something the client just decides to do spontaneously; it will occur in response to a specific request from the user to end the lease. A user may terminate a lease for a number of reasons, including the following:

- 🕒 The client is being moved to a different network;
- 🕒 The network is having its IP addresses renumbered;
- 🕒 The user wants the host to negotiate a new lease with a different server;

-
- ☉ The user wants to reset the lease to fix some sort of a problem.

In any of these cases, the user can end the lease through a process called *early lease termination* or *lease release*. This is a very simple, unidirectional communication. The client sends a special *DHCPRELEASE* message unicast to the server that holds its current lease, to tell it that the lease is no longer required. The server then records the lease as having been ended. It does not need to reply back to the client.

The reason that the client can just assume that the lease termination has been successful is that this is not a mandatory part of the DHCP protocol. Having clients send *DHCPRELEASE* to end a lease is considered a courtesy, rather than a requirement. It is more efficient to have clients inform servers when they no longer need a lease, and this also allows the IP address in the terminated lease to be reused more quickly. However, DHCP servers are designed to handle the case where a client “disappears” without formally ending an existing lease.

DHCP Parameter Configuration Process For Clients With Non-DHCP Addresses

The majority of DHCP clients make use of the protocol to obtain both an IP address and other configuration parameters. This is the reason why so much of DHCP is oriented around address assignment and leasing. A conventional DHCP client obtains all its configuration parameters at the same time it gets an IP address, using the message exchanges and processes we have seen in the preceding topics of this section.

The Motivation for a Distinct Parameter Configuration Process

There are cases, however, where a device with an IP address assigned using a method other than DHCP still wants to use DHCP servers to obtain other configuration parameters. The main advantage of this is administrative convenience; it allows a device with a static IP address to still be able to automatically get other parameters the same way that regular DHCP clients do.

Ironically, one common case where this capability can be used is... configuring DHCP servers themselves! Administrators normally do not use DHCP to provide an IP address to a DHCP server, but they may want to use it to tell the server other parameters. In this case, the server requesting the parameters actually acts as a client for the purpose of the exchange with another server.

The original DHCP standard did not provide any mechanism for this sort of non-IP configuration to take place. RFC 2131 revised the protocol, adding a new message type (*DHCPINFORM*) that allows a device to request configuration parameters without going through the full leasing process. This message is used as part of a simple bidirectional communication that is separate from the leasing communications we have looked at so far. Since it doesn't involve IP address assignment, it is not part of the [lease “life cycle”](#), nor is it part of the [DHCP client finite state machine](#).

Parameter Configuration Process Steps

The following steps show how a device with an externally-configured address uses DHCP to get other parameters (see [Figure 266](#) as well).

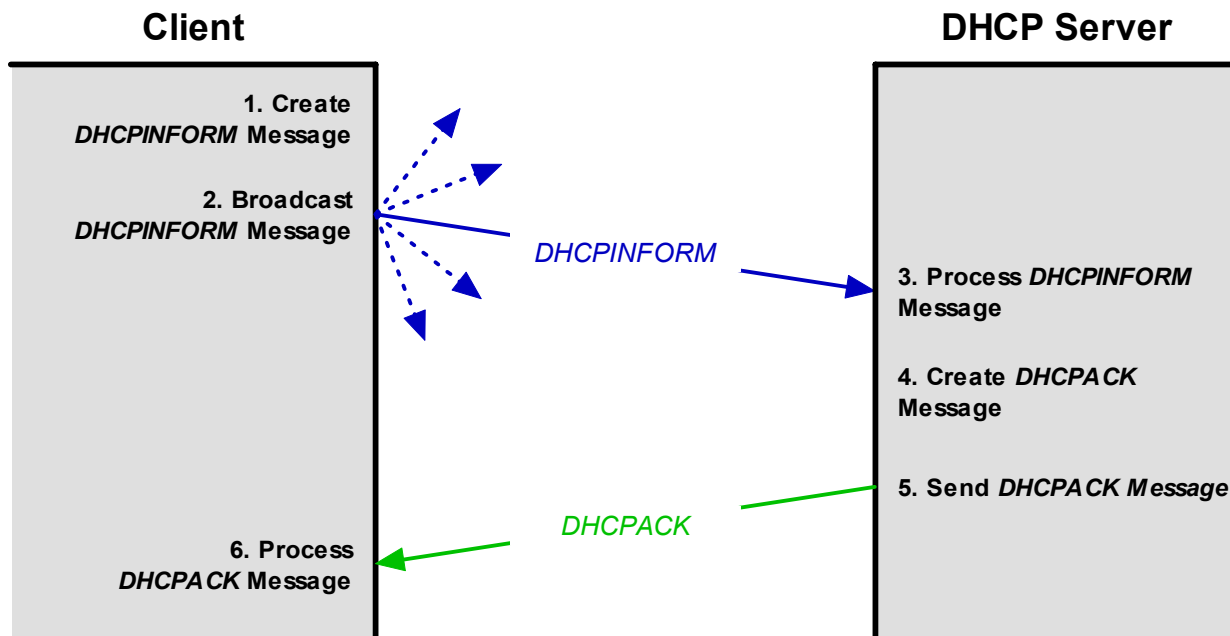

Figure 266: DHCP Parameter Configuration Process

A device that already has an IP address can use the simple request/reply exchange shown above to get other configuration parameters from a DHCP server. In this case I have shown the client broadcasting its request.

1. Client Creates *DHCPINFORM* Message

The client (which again, may be a DHCP server acting as a client) creates a *DHCPINFORM* message. It fills in its own IP address in the *CIAddr* field, since that IP address is current and valid. It may request specific parameters using the *Parameter Request List* option, or simply accept the defaults provided by the server.

2. Client Sends *DHCPINFORM* Message

The client sends the *DHCPINFORM* message unicast, if it knows the identity and address of a DHCP server, otherwise, it broadcasts it.

3. Server Receives and Processes *DHCPINFORM* Message

The message is received and processed by the DHCP server or servers (if there are multiple and the request was broadcast). Each server checks to see if it has the parameters needed by the client in its database.

4. Server Creates *DHCPACK* Message

Each server that has the information the client needs creates a *DHCPACK* message, which includes the needed parameters in the appropriate DHCP [option fields](#). (Often this will be only a single server.)

5. Server Sends *DHCPACK* Message

The server sends the message unicast back to the client.

6. Client Receives and Processes *DHCPACK* Message

The client receives the *DHCPACK* message sent by the server, processes it, and sets its parameters accordingly.

Dealing with Failure of the Configuration Process

If a client receives no reply to its *DHCPINFORM* message it will retransmit it periodically. After a retry period it will give up and use default configuration values. It will also typically generate an error report to inform an administrator or user of the problem.



Key Concept: Devices that are not using DHCP to acquire IP addresses can still utilize its other configuration capabilities. A client can broadcast a *DHCPINFORM* message to request that any available server send it parameters for how the network is to be used. DHCP servers respond with the requested parameters and/or default parameters, carried in DHCP options of a *DHCPACK* message.



DHCP Messaging, Message Types and Formats

The [topics on DHCP configuration and operation](#) demonstrated how DHCP works by showing the processes by which various leasing and information-exchange activities are accomplished. All of these procedures rely heavily on the exchange of information between client and server, which are carried in DHCP *messages*. Like all protocols, DHCP uses a special message format, and a set of rules that govern how messages are created, addressed and transported.

In this section I provide the details of how DHCP creates and sends messages, and show the formats used for DHCP messages and options. I begin with a description of how DHCP creates, addresses and transports messages, and how it deals with message retransmission. I then outline the DHCP general message format, showing how it is similar to the BOOTP message format upon which it is based, and also where it differs. I describe DHCP options, the format used for them, and the special option “overloading” feature used for efficiency. I conclude the section with a complete list of DHCP options.



Related Information: DHCP is most closely related to BOOTP in the area of messaging, so you'll find lots of references to BOOTP in this section. Note especially that DHCP options are based closely on [BOOTP vendor extensions](#), and many of the specific DHCP option types are the same as BOOTP vendor information fields. To avoid duplication, the summary table in this section lists the options/extensions for both protocols, indicating which ones are used by both BOOTP and DHCP, and which are used only by DHCP.

DHCP Message Generation, Addressing, Transport and Retransmission

In [the previous section](#), we examined extensively the operation of DHCP, and its client/server nature. Pretty much every aspect of the protocol's operation is oriented around the notion of a client device exchanging information with a server. We can also see this reflected in all of the major characteristics of DHCP messaging. This includes the format of DHCP messages, as well as the specifics of how DHCP messages are created, addressed and transmitted—and when necessary, *retransmitted*.

Message Generation and General Formatting

DHCP messaging is similar in many ways to that of BOOTP, the protocol upon which DHCP was based. BOOTP defined only two message types, a request and a reply. DHCP is of course much more complex, using some eight different types of messages, but these are still categorized as either request or reply messages, depending on who sends them and why. DHCP uses a special *DHCP Message Type option* to indicate the exact DHCP message type, but still treats a message from a client seeking information as a request, and a response from a server containing information as a reply.

A client generates a message using the [general DHCP message format](#), which is very similar to the [BOOTP message format](#). When a server replies to a client message it does not generate the reply as a completely new message, but rather copies the client request, changes fields as appropriate, and sends the reply back to the client. A special transaction identifier (*XID*) is placed in the request and maintained in the reply, which allows a client know which reply goes with a particular request.

Message Transport

DHCP uses [UDP](#) for transport just as BOOTP does, and for the same reasons: simplicity and support for broadcasts. It also has many of the same addressing concerns that we discussed in [the topic on BOOTP messaging and addressing](#). Clients usually will send requests by broadcast on the local network, to allow them to contact any available DHCP server. The exception to this is when a client is trying to renew a lease with a server that it already knows. For compatibility with BOOTP, DHCP uses the same well-known (reserved) UDP port number, 67, for client requests to servers.

Use of Broadcasts and Layer Two Message Delivery

Some DHCP message exchanges require a server to respond back to a client that has a valid and active IP address. An example is a *DHCPACK* sent in reply to a *DHCPINFORM* request. In this situation, the server can always send a reply unicast back to the client. Other message exchanges, however, present the same “chicken and egg” conundrum that we saw with BOOTP: if a client is using DHCP to obtain an IP address, we can't assume that IP address is available for us to use to send a reply.

In BOOTP, there were two specified solution to this situation: first, the server could send back its reply using broadcast addressing as well; second, the server could send back a reply directly to the host at layer two. Due to the performance problems associated with broadcasts, DHCP tries to make the latter method the default for server replies. It assumes that a client's TCP/IP software will be capable of accepting and processing an IP datagram delivered at layer two, even before the IP stack is initialized.

As the standard itself puts it, “DHCP requires creative use of the client's TCP/IP software and liberal interpretation of RFC 1122”. RFC 1122 is a key standard describing the detailed implementation requirements of TCP/IP hosts. The DHCP standard, however, acknowledges the fact that not all devices may support this behavior. It allows a client to force servers to send back replies using broadcasts instead. This is done by the client setting the special *Broadcast (B)* flag to 1 in its request.

Since DHCP, like BOOTP, must use either layer two delivery or layer three broadcasts for server replies, it requires a separate well-known port number for servers to send to. Again, for compatibility with BOOTP, the same port number is used, 68. This port number is used whether a server reply is sent unicast or broadcast.



Key Concept: Requests from BOOTP clients are normally sent broadcast, to reach any available DHCP server. However, there are certain exceptions, such as in lease renewal, when a request is sent directly to a known server. DHCP servers can send their replies either broadcast to the special port number reserved for DHCP clients, or unicast using layer two. The DHCP standards specify that layer two delivery should be used when possible to avoid unnecessary broadcast traffic.

Retransmission of Lost Messages

Using UDP provides benefits such as simplicity and efficiency to DHCP, but since UDP is unreliable, there is no guarantee that messages will get to their destination. This can lead to potential confusion on the part of a client. Consider, for example, a client sending a *DHCPDISCOVER* message and waiting for *DHCPOFFER* messages in reply. If it gets no response, does this mean that there is no DHCP server willing to offer it service, or simply that its *DHCPDISCOVER* got “munched” somewhere on the network? The same applies to most other request/reply sequences, such as a client waiting for a *DHCPACK* or *DHCPNAK* in reply to a *DHCPREQUEST* or *DHCPINFORM*.

The fact that messages can be lost means that DHCP itself must keep track of messages sent and if there is no response, retransmit them. Since there are so many message exchanges in DHCP, there is much more that can “go wrong”. As in BOOTP, DHCP puts responsibility for this squarely on the shoulders of the client. This makes sense, since the client initiates contact and can most easily keep track of messages sent and retransmit them when needed. A server can't know when a client's request is lost, but a client **can** react to a server's reply being lost.

In any request/reply message exchange, the client uses a retransmission timer that is set to a period of time that represents how long it is reasonable for it to wait for a response. If no reply is received by the time the timer expires, the client assumes that either its request or the response coming back was lost. The client then retransmits the request. If this request again elicits no reply, the client will continue retransmitting for a period of time.

To prevent large numbers of DHCP clients from retransmitting requests simultaneously (which would potentially clog the network), the client must use a randomized exponential backoff algorithm to determine when exactly a retransmission is made. As in BOOTP, this is similar to the technique used to recover from collisions in Ethernet. The DHCP standard specifies that the delay should be based on the speed of the underlying network between the client and the server. More specifically, it says that in a standard Ethernet network, the first retransmission should be delayed 4 seconds plus or minus a random value from 0 to 1 second—in other words, some value is chosen between 3 and 5 seconds. The delay is then doubled with each subsequent transmission (7 to 9 seconds, then 15 to 17 seconds and so forth) up to a maximum of 64 +/- 1 second.

To prevent it from retrying endlessly, the client normally has logic that limits the number of retries. The amount of time that retransmissions go on depends on the type of request being sent; that is, what process is being undertaken. If a client is forced to “give up” due to too many retries it will generally either take some sort of default action or generate an error message.



Key Concept: Like BOOTP, DHCP uses UDP for transport, which provide no reliability features. DHCP clients must detect when requests are sent and no response is received, and retransmit requests periodically. Special logic is used to prevent clients from sending excessive numbers of requests during difficult network conditions.

DHCP Message Format

When DHCP was created, its developers had a bit of an issue related to how exactly they should structure DHCP messages. BOOTP was already widely used, and maintaining compatibility between DHCP and BOOTP was an important goal. This meant that DHCP's designers needed to continue using the existing BOOTP message format. However, DHCP has more functionality than BOOTP, and this means more information than can easily be held in the limited [BOOTP message format](#).

This apparent contradiction was resolved in two ways. First, the existing BOOTP message format was maintained for basic functionality, but DHCP clients and servers were programmed to use the BOOTP message fields in slightly different ways. Second, the BOOTP vendor extensions were formalized and became DHCP *options*, as we'll see in the next two topics. Despite the name “options”, some of these are in fact the additional fields needed for basic DHCP functionality, and are quite mandatory. 😊

With this dual approach, DHCP devices have access to the extra information they need. Meanwhile, the basic field format is unchanged, which allows DHCP servers to communicate with older BOOTP clients, which ignore the extra DHCP information that doesn't relate to them. [See the topic on BOOTP/DHCP interoperability for more](#).

[Table 190](#) describes the format of DHCP messages, which is also shown in [Figure 267](#). In the table, I have specifically indicated which fields are used in DHCP in a manner similar to how they are used in BOOTP, and which are significantly different.

Table 190: DHCP Message Format (Page 1 of 3)

Field Name	Size (bytes)	Description																										
Op	1	<p>Operation Code: Specifies the general type of message. A value of 1 indicates a request message, while a value of 2 is a reply message.</p> <p>This code represents the general category of the DHCP message; a client sending a request to a server uses an <i>Op</i> code of 1, while a server replying uses a code of 2. So, for example, a <i>DHCPREQUEST</i> would be a request, while a <i>DHCPACK</i> or <i>DHCPNAK</i> is a reply. The actual specific type of DHCP message is encoded using the DHCP Message Type option.</p>																										
HType	1	<p>Hardware Type: This field specifies the type of hardware used for the local network, and is used in exactly the same way as the equivalent field (<i>HRD</i>) in the Address Resolution Protocol (ARP) message format. Some of the most common values for this field:</p> <table border="1"> <thead> <tr> <th>HType Field Value</th> <th>Hardware Type</th> </tr> </thead> <tbody> <tr> <td>1</td> <td>Ethernet (10 Mb)</td> </tr> <tr> <td>6</td> <td>IEEE 802 Networks</td> </tr> <tr> <td>7</td> <td>ARCNET</td> </tr> <tr> <td>11</td> <td>LocalTalk</td> </tr> <tr> <td>12</td> <td>LocalNet (IBM PCNet or SYTEK LocalNET)</td> </tr> <tr> <td>14</td> <td>SMDS</td> </tr> <tr> <td>15</td> <td>Frame Relay</td> </tr> <tr> <td>16</td> <td>Asynchronous Transfer Mode (ATM)</td> </tr> <tr> <td>17</td> <td>HDLC</td> </tr> <tr> <td>18</td> <td>Fibre Channel</td> </tr> <tr> <td>19</td> <td>Asynchronous Transfer Mode (ATM)</td> </tr> <tr> <td>20</td> <td>Serial Line</td> </tr> </tbody> </table>	HType Field Value	Hardware Type	1	Ethernet (10 Mb)	6	IEEE 802 Networks	7	ARCNET	11	LocalTalk	12	LocalNet (IBM PCNet or SYTEK LocalNET)	14	SMDS	15	Frame Relay	16	Asynchronous Transfer Mode (ATM)	17	HDLC	18	Fibre Channel	19	Asynchronous Transfer Mode (ATM)	20	Serial Line
HType Field Value	Hardware Type																											
1	Ethernet (10 Mb)																											
6	IEEE 802 Networks																											
7	ARCNET																											
11	LocalTalk																											
12	LocalNet (IBM PCNet or SYTEK LocalNET)																											
14	SMDS																											
15	Frame Relay																											
16	Asynchronous Transfer Mode (ATM)																											
17	HDLC																											
18	Fibre Channel																											
19	Asynchronous Transfer Mode (ATM)																											
20	Serial Line																											
HLen	1	<p>Hardware Address Length: Specifies how long hardware addresses are in this message. For Ethernet or other networks using IEEE 802 MAC addresses, the value is 6. This is also the same as a field in the ARP field format, <i>HLN</i>.</p>																										
Hops	1	<p>Hops: Set to 0 by a client before transmitting a request and used by relay agents to control the forwarding of BOOTP and/or DHCP messages.</p>																										
XID	4	<p>Transaction Identifier: A 32-bit identification field generated by the client, to allow it to match up the request with replies received from DHCP servers.</p>																										
Secs	2	<p>Seconds: In BOOTP this field was vaguely defined and not always used. For DHCP, it is defined as the number of seconds elapsed since a client began an attempt to acquire or renew a lease. This may be used by a busy DHCP server to prioritize replies when multiple client requests are outstanding.</p>																										

Table 190: DHCP Message Format (Page 2 of 3)

Field Name	Size (bytes)	Description									
Flags	2	<p>Flags: This corresponds to the formerly empty two-byte field in the BOOTP message format defined by RFC 951, which was redefined as a <i>Flags</i> field in RFC 1542. The field presently contains just one flag subfield, as follows:</p> <table border="1"> <thead> <tr> <th>Subfield Name</th> <th>Size (bytes)</th> <th>Description</th> </tr> </thead> <tbody> <tr> <td>B</td> <td>1/8 (1 bit)</td> <td>Broadcast Flag: A client that doesn't know its own IP address at the time it sends its request sets this flag to 1. This serves as an immediate indicator to the DHCP server or relay agent that receives the request that it should send its reply back by broadcast.</td> </tr> <tr> <td>Reserved</td> <td>1 7/8 (15 bits)</td> <td>Reserved: Set to zero and not used.</td> </tr> </tbody> </table>	Subfield Name	Size (bytes)	Description	B	1/8 (1 bit)	Broadcast Flag: A client that doesn't know its own IP address at the time it sends its request sets this flag to 1. This serves as an immediate indicator to the DHCP server or relay agent that receives the request that it should send its reply back by broadcast.	Reserved	1 7/8 (15 bits)	Reserved: Set to zero and not used.
Subfield Name	Size (bytes)	Description									
B	1/8 (1 bit)	Broadcast Flag: A client that doesn't know its own IP address at the time it sends its request sets this flag to 1. This serves as an immediate indicator to the DHCP server or relay agent that receives the request that it should send its reply back by broadcast.									
Reserved	1 7/8 (15 bits)	Reserved: Set to zero and not used.									
CIAddr	4	<p>Client IP Address: The client puts its own current IP address in this field if and only if it has a valid IP address while in the <i>BOUND</i>, <i>RENEWING</i> or <i>REBINDING</i> states; otherwise, it sets the field to 0. The client can only use this field when its address is actually valid and usable, not during the process of acquiring an address. Specifically, the client does not use this field to request a particular IP address in a lease; it uses the <i>Requested IP Address DHCP option</i>.</p>									
YIAddr	4	<p>"Your" IP Address: The IP address that the server is assigning to the client.</p>									
SIAddr	4	<p>Server IP Address: The meaning of this field is slightly changed in DHCP. In BOOTP, it is the IP address of the BOOTP server sending a <i>BOOTREPLY</i> message. In DHCP, it is the address of the server that the client should use for the next step in the bootstrap process, which may or may not be the server sending this reply.</p> <p>The sending server always includes its own IP address in the <i>Server Identifier DHCP option</i>.</p>									
GIAddr	4	<p>Gateway IP Address: This field is used just as it is in BOOTP, to route BOOTP messages when BOOTP relay agents are involved to facilitate the communication of BOOTP requests and replies between a client and a server on different subnets or networks. See the topic on DHCP relaying. As with BOOTP, this field is not used by clients and does not represent the server giving the client the address of a default router (that's done using the <i>Router DHCP option</i>).</p>									
CHAddr	16	<p>Client Hardware Address: The hardware (layer two) address of the client, which is used for identification and communication.</p>									

Table 190: DHCP Message Format (Page 3 of 3)

Field Name	Size (bytes)	Description
SName	64	<p>Server Name: The server sending a <i>DHCPOFFER</i> or <i>DHCPACK</i> message may optionally put its name in this field. This can be a simple text “nickname” or a fully-qualified DNS domain name (such as “myserver.organization.org”).</p> <p>This field may also be used to carry DHCP options, using the “option overload” feature, indicated by the value of the DHCP <i>Option Overload</i> option.</p>
File	128	<p>Boot Filename: Optionally used by a client to request a particular type of boot file in a <i>DHCPDISCOVER</i> message. Used by a server in a <i>DHCPOFFER</i> to fully specify a boot file directory path and filename.</p> <p>This field may also be used to carry DHCP options, using the “option overload” feature, indicated by the value of the DHCP <i>Option Overload</i> option.</p>
Options	Variable	<p>Options: Holds DHCP options, including several parameters required for basic DHCP operation. Note that this field was fixed at 64 bytes in length in BOOTP but is variable in length in DHCP. See the next two topics for more information. This field may be used by both client and server.</p>

The DHCP standard does not specify the details of how DHCP messages are encapsulated within UDP. I would assume that due to the other similarities to BOOTP, DHCP maintains BOOTP's optional use of message checksums. It also most likely assumes that messages will not be fragmented (sent with the *Do Not Fragment* bit set to 1 in the [IP datagram](#)). This is to allow BOOTP clients to avoid the complexity of [reassembling fragmented messages](#).

I should point out, however, that DHCP messages are variable in length, compared to BOOTP's fixed message size. This was done by changing BOOTP's 64-byte *Vend* field into the variable-length *Options* field. DHCP relies on options much more than BOOTP does, and a device must be capable of accepting a message with an *Options* field at least 312 bytes in length. The *SName* and *File* fields may also be used to carry options, as described in the next topic.

DHCP Options, Option Format and "Option Overloading"

When BOOTP was first developed, its [message format](#) included a 64-byte *Vend* field, called the *Vendor-Specific Area*. The idea behind this field was to provide flexibility to the protocol. The BOOTP standard did not define any specific way of using this field. Instead, the field was left open for the creators of different types of hardware to use it to customize BOOTP to meet the needs of their clients and/or servers.

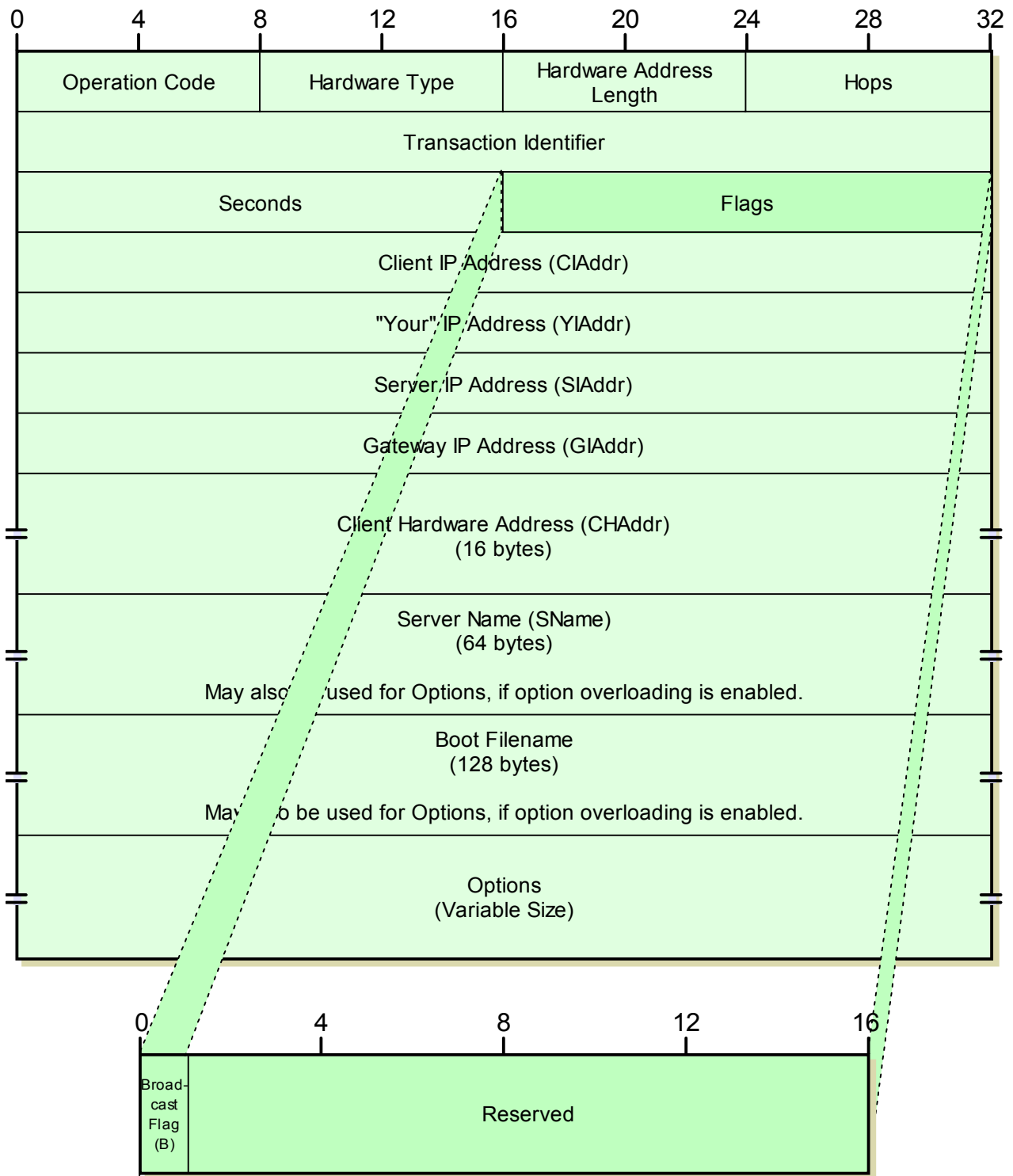

Figure 267: DHCP Message Format

Including this sort of “undefined” field is always a good idea because it makes a protocol easily *extensible*. That is, allows the protocol to be easily enhanced in the future through the definition of new fields while not disturbing any existing fields. The problem with the BOOTP *Vendor-Specific Area*, however, is that the extensibility was in fact **vendor-specific**. It was useful only for special fields that were particular to a single vendor.

What was really needed was a way to define new fields for general purpose, vendor-independent parameter communication, but there was no field in the BOOTP message format that would let this happen. The solution came in the form of RFC 1048, which defined a technique called BOOTP *vendor information extensions*. This method redefines the vendor-specific area to allow it to carry general parameters between client and server. This idea was so successful that it **largely replaced the older vendor-specific use** of the *Vend* field.

Options and Option Format

DHCP maintains, formalizes and further extends the idea of using the *Vend* field to carry general-purpose parameters. Instead of being called vendor information extensions, or vendor information fields, these fields are now called simply DHCP *options*. Similarly, the *Vend* field has been renamed the *Options* field, reflecting its new role as a way of conveying vendor-independent options between client and server.

Keeping with the desire to maintain compatibility between BOOTP and DHCP, the DHCP *Options* field is in most ways the same as the vendor-independent interpretation of the BOOTP *Vend* field introduced by RFC 1048. The first four bytes of the field still carry the “magic cookie” value “99.130.83.99” to identify the information as vendor-independent option fields. The rest of the *Option* field consists of one or more subfields, each of which has a “type, length, value” (*TLV-encoded*) substructure as in BOOTP. The main differences between BOOTP vendor information fields and DHCP options are the field names and the fact that the DHCP *Options* field is variable in length where the BOOTP *Vend* field is fixed at 64 bytes. The structure of the DHCP *Options* field as a whole is shown in [Figure 268](#); the subfield names of each option are described in [Table 191](#).

Table 191: DHCP Option Format

Subfield Name	Size (bytes)	Description
Code	1	Option Code: A single octet that specifies the option type.
Len	1	Option Length: The number of bytes in this particular option. This does not include the two bytes for the <i>Code</i> and <i>Len</i> fields.
Data	Variable	Option Data: The data being sent, which has a length indicated by the <i>Len</i> subfield, and which is interpreted based on the <i>Code</i> subfield.

All of the DHCP options follow the format of [Table 191](#), except for two special cases, again the same as BOOTP. A *Code* value of 0 is used as a *pad*, when subfields need to be aligned on word boundaries; it contains no information. The value 255 is used to mark the end of the vendor information fields. Both of these codes contain no actual data, so to save

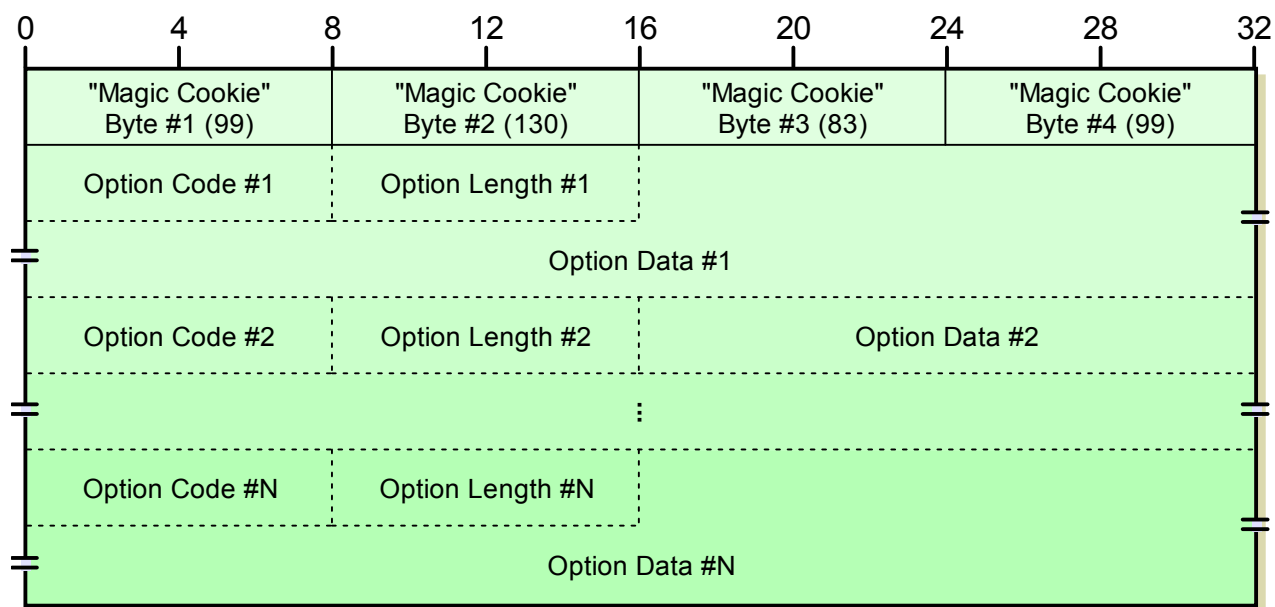

Figure 268: DHCP Options Field Format

The format of the DHCP *Options* field is, unsurprisingly, very similar to that of the BOOTP *Vendor-Specific Area*, as shown in [Figure 257](#). The *Options* field begins with the same four-byte “magic cookie” and then contains a number of variable-length option fields. Each option has the format described in [Table 191](#).

space, when either is used just the single *Code* value is included; the *Len* and *Data* fields are omitted. A device seeing a *Code* value of 0 just skips it as filler; a device seeing a *Code* value of 255 knows it has reached the end of the fields in this *Options* field.

Option Categories

Before DHCP was invented, a series of BOOTP standards was published defining the current list of BOOTP vendor information extensions. When DHCP was developed, a single standard was created that merged both BOOTP vendor information extensions and DHCP options, since again, they are basically the same. The most recent of these is RFC 2132, entitled (ta-da!) *DHCP Options and BOOTP Vendor Extensions*.

RFC 2132 lists several dozen fields that can be used either as DHCP options or BOOTP vendor information fields. For easier “digestion”, these are broken into several categories. In addition, there is also a set of fields that are used only in DHCP, not in BOOTP. Despite being called “options”, only some really are optional; others are necessary for the basic

operation of DHCP. They are carried as “option” fields for only one reason: to allow DHCP to keep using the same basic message format as BOOTP for compatibility. [Table 192](#) summarizes the categories used for DHCP options.

Table 192: DHCP Option Categories

Option Category	Description
RFC 1497 Vendor Extensions	The BOOTP vendor extensions defined in RFC 1497, the last RFC describing vendor extension fields that was BOOTP-specific (before DHCP was created). For easier reference, these were kept in a single group when DHCP options were created, even though some of the functions they represent might better belong in other categories.
IP Layer Parameters Per Host	Parameters that control the operation of the Internet Protocol on a host, which affect the host as a whole and are not interface-specific.
IP Layer Parameters Per Interface	Parameters that affect the operation of the Internet Protocol for a particular interface of a host. (Some devices have only one interface, of course, while others have more.)
Link Layer Parameters Per Interface	Parameters that affect the data link layer operation of a host, on a per-interface basis.
TCP Parameters	Parameters that impact the operation of the TCP layer; specified on a per-interface basis.
Application and Service Parameters	Parameters used to configure or control the operation of various miscellaneous applications or services.
DHCP Extensions	Parameters that are DHCP-specific, and used to control the operation of the DHCP protocol itself.

The [next topic](#) provides a complete list of the DHCP options defined in RFC 2132. Due to the popularity of DHCP, several other options have been defined since that standard was published. Each time a new option is created, documenting it would have required a new successor to RFC 2132, which would be confusing and time-consuming. Instead, the maintenance of these options / extensions has been moved from the RFC process to a set of files maintained by the [IANA](#), just like so many other parameters. There is also a process by which a developer can request additional standard extensions to be added to DHCP. This is described in section 10 of RFC 2132.



Key Concept: DHCP takes BOOTP’s vendor information extensions and formalizes them into an official feature called *DHCP options*. The *BOOTP Vendor-Specific Area* field becomes the *DHCP Options* field, and can contain an arbitrary number of parameters to be sent from the server to the client. Some of these include pieces of data that are actually mandatory for the successful operation of DHCP. There are several dozen DHCP options, which are divided into functional categories.

Option Overloading

Since DHCP relies so much more on the use of options than BOOTP did, the size of the *Options* field could theoretically grow quite large. However, since DHCP is using UDP for transport, the overall size of a message is limited. This could theoretically have led to a situation where a message might run out of room and be unable to carry all its options. Meanwhile, there are two “spacious” fields in the message format, *SName* and *File*, at 64 and 128 bytes respectively. These fields might not even be needed in some cases, because many devices use DHCP for getting a lease and parameters and not to download a boot image. Even if they *are* needed, they might be carrying much less information than their large fixed size allows.

To make better use of the total space in the message format, DHCP includes a special feature called *option overloading*, which allows these two fields to be used to carry more option fields instead of their conventional information. Use of this option is itself indicated through the use of a DHCP option, *Option Overload*, which tells a device receiving a message how to interpret the two fields. If option overload is used, the *SName* and/or *File* fields are read and interpreted in the same way as the *Options* field, after all options in the *Option* field are parsed. If the message actually does need to carry a server name or boot file, these are included as separate options (number 66 and number 67, respectively), which are variable-length and can therefore be made exactly the length needed. Again, [see the next topic for details](#).



Key Concept: Since DHCP messages can contain so many options, a special feature called *option overloading* was created. When enabled, overloading allows options to make use of the large *SName* and *File* fields in the DHCP message format for options.

Combining Vendor-Independent and Vendor-Specific Information

Incidentally, the creators of DHCP did recognize that even though vendor-independent options are important, a vendor might want to be able to send vendor-specific information just as the original BOOTP defined. To this end, they created a DHCP option called *Vendor Specific Information*. This option allows a vendor to encapsulate a set of vendor-specific option fields within the normal DHCP option structure.

In essence, you can think of this as a way of nesting a conventional BOOTP *Vend* field (of variable length) within a single DHCP option. Other DHCP options can be carried simultaneously, subject to overall message length limits. Note that this supplements an already-existing BOOTP option that allows reference to be made to a file containing vendor-specific information.

Summary Of DHCP Options / BOOTP Vendor Information Fields

BOOTP *vendor information fields* are used to carry additional vendor-independent configuration parameters. These were used as the basis for DHCP *options*, which extend the concept to include parameters used to manage the operation of DHCP as a whole, as described in [the preceding topic](#). Since BOOTP vendor information fields and DHCP options are essentially the same (except for the DHCP-specific fields), they are described in the same TCP/IP standard, and hence, in this single Guide topic.

Below I have included a number of tables, organized by the RFC 2132 option categories, that list each of the DHCP options / BOOTP vendor information fields. I have shown each option's *Code* value, and the length of the *Data* subfield for the option, in bytes. I have then provided the formal name of the option and a brief description of how it is used. For simplicity, in the tables below I say just “options”; please read “option” as “option / vendor information field”, since they are the same (except, again, the DHCP-specific options.)

There are a lot of options in these tables, and some of them define parameters that are used by somewhat obscure protocols that I may not cover in this Guide, so don't be put off if the brief description is not enough for you to completely understand how each and every option is used. Other options will seem quite familiar to you based on other discussions in this Guide. Note in particular that many of the original BOOTP vendor information fields that are used to communicate the addresses of certain types of servers are now archaic and may no longer be used.

RFC 1497 Vendor Extensions

[Table 193](#) shows the DHCP/BOOTP options that were originally defined in RFC 1497.

Table 193: DHCP/BOOTP Options: RFC 1497 Vendor Extensions (Page 1 of 3)

Code Value	Data Length (bytes)	Name and Description
0	0	Pad: A single byte used as “filler” to align a subsequent field on a word (two-byte) boundary. Contains no information. One of two options that is a single byte in length, having no <i>Data</i> subfield (the other being the <i>End</i> option below.)
1	4	Subnet Mask: A 32-bit subnet mask being supplied for the client to use on the current network. Must appear in the option list before the <i>Router</i> option if both are present.
2	4	Time Offset: Specifies the time offset of the client's subnet in seconds from <i>Coordinated Universal Time (UTC, formerly Greenwich Mean Time or GMT)</i> . Positive values represent areas east of the prime meridian (in the United Kingdom), negative values areas west. Essentially, this is used to indicate the time zone of the subnet.

Table 193: DHCP/BOOTP Options: RFC 1497 Vendor Extensions (Page 2 of 3)

Code Value	Data Length (bytes)	Name and Description
3	Variable (Multiple of 4)	Router: Specifies a list of 32-bit router addresses for the client to use on the local network. Routers are listed in the order of preference for the client to use.
4	Variable (Multiple of 4)	Time Server: Specifies a list of time server addresses (per RFC 868) for the client to use on the local network. Servers are listed in the order of preference for the client to use.
5	Variable (Multiple of 4)	IEN-116 Name Server: Specifies a list of IEN-116 name server addresses for the client to use on the local network. Servers are listed in the order of preference for the client to use. Note that this option is not used for DNS name servers; see below.
6	Variable (Multiple of 4)	DNS Name Server: Specifies a list of DNS name server addresses for the client to use on the local network. Servers are listed in the order of preference for the client to use.
7	Variable (Multiple of 4)	Log Server: Specifies a list of MIT-LCS UDP log server addresses for the client to use on the local network. Servers are listed in the order of preference for the client to use.
8	Variable (Multiple of 4)	Cookie Server: Specifies a list of RFC 865 “cookie” server addresses for the client to use on the local network. Servers are listed in the order of preference for the client to use.
9	Variable (Multiple of 4)	LPR Server: Specifies a list of RFC 1179 line printer server addresses for the client to use on the local network. Servers are listed in the order of preference for the client to use.
10	Variable (Multiple of 4)	Impress Server: Specifies a list of Imagen Impress server addresses for the client to use on the local network. Servers are listed in the order of preference for the client to use.
11	Variable (Multiple of 4)	Resource Location Server: Specifies a list of RFC 887 resource location server addresses for the client to use on the local network. Servers are listed in the order of preference for the client to use.
12	Variable	Host Name: Specifies a host name for the client. This may or may not be a DNS host name; see option #15 below.
13	2	Boot File Size: Specifies the size of the default boot image file for the client, expressed in units of 512 bytes.
14	Variable	Merit Dump File: Specifies the path and filename of the file to which the client should dump its core image in the event that it crashes.
15	Variable	Domain Name: Specifies the DNS domain name for the client. Compare to option #12.
16	4	Swap Server: Specifies the address of the client's swap server.
17	Variable	Root Path: Specifies the path name of the client's root disk. This allows the client to access files it may need, using a protocol such as NFS .

Table 193: DHCP/BOOTP Options: RFC 1497 Vendor Extensions (Page 3 of 3)

Code Value	Data Length (bytes)	Name and Description
18	Variable	<p>Extensions Path: Specifies the name of a file that contains vendor-specific fields that the client can interpret in the same way as the <i>Options</i> or <i>Vend</i> field in a DHCP/BOOTP message. This was defined to allow a client and server to still exchange vendor-specific information even though the <i>Option/Vend</i> field is now used for the general-purpose fields described in this topic.</p> <p>Also see option #43 below.</p>
255	0	<p>End: Placed after all other options to mark the end of the option list.</p> <p>One of two options that is a single byte in length, having no <i>Data</i> subfield (the other being the <i>Pad</i> option above.)</p>

IP Layer Parameters Per Host

These are parameters that control the operation of IP on a host as a whole (not interface-specific) see [Table 194](#).

Table 194: DHCP/BOOTP Options: IP Layer Parameters Per Host

Code Value	Data Length (bytes)	Name and Description
19	1	<p>IP Forwarding Enable/Disable: A value of 1 turns on IP forwarding (that is, routing) on a client that is capable of that function; a value of 0 turns it off.</p>
20	1	<p>Non-Local Source Routing Enable/Disable Option: A value of 1 tells a client capable of routing to allow forwarding of IP datagrams with non-local source routes. A value of 0 tells the client not to allow this.</p> <p>See the source routing IP datagram option for a bit more information on this and option #21 below.</p>
21	Variable (Multiple of 8)	<p>Policy Filter: A set of address/mask pairs used to filter non-local source-routed datagrams.</p>
22	2	<p>Maximum Datagram Reassembly Size: Tells the client the size of the largest datagram that the client should be prepared to reassemble. The minimum value is 576 bytes.</p>
23	1	<p>Default IP Time-To-Live: Specifies the default value that the client should use for the <i>Time To Live</i> field in creating IP datagrams.</p>
24	4	<p>Path MTU Aging Timeout: Specifies the number of seconds the client should use in aging path MTU values determined using Path MTU discovery.</p>
25	Variable (Multiple of 2)	<p>Path MTU Plateau Table: Specifies a table of values to be used in performing path MTU discovery.</p>

IP Layer Parameters Per Interface

These parameters are specific to a particular host interface at the IP level ([Table 195](#))

Table 195: DHCP/BOOTP Options: IP Layer Parameters Per Interface

Code Value	Data Length (bytes)	Name and Description
26	2	Interface MTU: Specifies the maximum transmission unit (MTU) to be used for IP datagrams on this interface. Minimum value is 68.
27	1	All Subnets Are Local: When set to 1, tells the client that it may assume that all subnets of the IP network it is on have the same MTU as its own subnet. When 0, the client must assume that some subnets may have smaller MTUs than the client's subnet.
28	4	Broadcast Address: Tells the client what address it should use for broadcasts on this interface.
29	1	Perform Mask Discovery: A value of 1 tells the client that it should use ICMP to discover a subnet mask on the local subnet. A value of 0 tells the client not to perform this discovery.
30	1	Mask Supplier: Set to 1 to tell the client that it should respond to ICMP subnet mask requests on this interface.
31	1	Perform Router Discovery: A value of 1 tells the client to use the ICMP router discovery process to solicit a local router. A value of 0 tells the client to not do so. Note that DHCP itself can be used to specify one or more local routers using option #3 above.
32	4	Router Solicitation Address: Tells the client the address to use as the destination for router solicitations.
33	Variable (Multiple of 8)	Static Route: Provides the client with a list of static routes it can put into its routing cache. The list consists of a set of IP address pairs; each pair defines a destination and a router to be used to reach the destination.

Link Layer Parameters Per Interface

[Table 196](#) lists the DHCP/BOOTP options that are specific to a particular link layer (layer two) interface.

Table 196: DHCP/BOOTP Options: Link Layer Parameters Per Interface (Page 1 of 2)

Code Value	Data Length (bytes)	Name and Description
34	1	Trailer Encapsulation: When set to 1, tells the client to negotiate the use of trailers, as defined in RFC 893. A value of 0 tells the client not to use this feature.

Table 196: DHCP/BOOTP Options: Link Layer Parameters Per Interface (Page 2 of 2)

Code Value	Data Length (bytes)	Name and Description
35	4	ARP Cache Timeout: Specifies how long, in seconds, the client should hold entries in its ARP cache .
36	1	Ethernet Encapsulation: Tells the client what type of encapsulation to use when transmitting over Ethernet at layer two. If the option value is 0, specifies that Ethernet II encapsulation should be used, per RFC 894; when the value is 1, tells the client to use IEEE 802.3 encapsulation, per RFC 1042.

TCP Parameters

The options impacting the operation of TCP are shown in [Table 197](#).

Table 197: DHCP/BOOTP Options: TCP Parameters

Code Value	Data Length (bytes)	Name and Description
37	1	Default TTL: Specifies the default <i>Time To Live</i> the client should use when sending TCP segments.
38	4	TCP Keepalive Interval: Specifies how long (in seconds) the client should wait on an idle TCP connection before sending a “keepalive” message. A value of 0 instructs the client not to send such messages unless specifically instructed to do so by an application.
39	1	TCP Keepalive Garbage: When set to 1, tells a client it should send TCP keepalive messages that include an octet of “garbage” for compatibility with implementations that require this.

Application and Service Parameters

These are miscellaneous options that control the operation of various applications and services ([Table 198](#)).

Table 198: DHCP/BOOTP Options: Application and Service Parameters (Page 1 of 3)

Code Value	Data Length (bytes)	Name and Description
40	Variable	Network Information Service Domain: Specifies the client’s NIS domain. Contrast to option #64.
41	Variable (Multiple of 4)	Network Information Servers: Specifies a list of IP addresses of NIS servers the client may use. Servers are listed in the order of preference for the client to use. Contrast to option #65.

Table 198: DHCP/BOOTP Options: Application and Service Parameters (Page 2 of 3)

Code Value	Data Length (bytes)	Name and Description																		
42	Variable (Multiple of 4)	Network Time Protocol Servers: Specifies a list of IP addresses of Network Time Protocol servers the client may use. Servers are listed in the order of preference for the client to use.																		
43	Variable	Vendor Specific Information: Allows an arbitrary set of vendor-specific information to be included as a single option within a DHCP or BOOTP message. This information is structured using the same format as the Options or Vend field itself, except that it does not start with a “magic cookie”. See the end of the previous topic for more details.																		
44	Variable (Multiple of 4)	NetBIOS Over TCP/IP Name Servers: Specifies a list of IP addresses of NetBIOS name servers (per RFC 1001/1002) that the client may use. Servers are listed in the order of preference for the client to use.																		
45	Variable (Multiple of 4)	NetBIOS Over TCP/IP Datagram Distribution Servers: Specifies a list of IP addresses of NetBIOS datagram distribution servers (per RFC 1001/1002) that the client may use. Servers are listed in the order of preference for the client to use.																		
46	1	<p>NetBIOS Over TCP/IP Node Type: Tells the client what sort of NetBIOS node type it should use. Four different bit values are used to define the possible node type combinations. The following table shows the substructure:</p> <table border="1"> <thead> <tr> <th>Subfield Name</th> <th>Size (bytes)</th> <th>Description</th> </tr> </thead> <tbody> <tr> <td>Reserved</td> <td>4/8 (4 bits)</td> <td>Reserved: Not used.</td> </tr> <tr> <td>H-Node</td> <td>1/8 (1 bit)</td> <td>H-Node: Set to 1 to tell the client to act as a NetBIOS H-node.</td> </tr> <tr> <td>M-Node</td> <td>1/8 (1 bit)</td> <td>M-Node: Set to 1 to tell the client to act as a NetBIOS M-node.</td> </tr> <tr> <td>P-Node</td> <td>1/8 (1 bit)</td> <td>P-Node: Set to 1 to tell the client to act as a NetBIOS P-node.</td> </tr> <tr> <td>B-Node</td> <td>1/8 (1 bit)</td> <td>B-Node: Set to 1 to tell the client to act as a NetBIOS B-node.</td> </tr> </tbody> </table>	Subfield Name	Size (bytes)	Description	Reserved	4/8 (4 bits)	Reserved: Not used.	H-Node	1/8 (1 bit)	H-Node: Set to 1 to tell the client to act as a NetBIOS H-node.	M-Node	1/8 (1 bit)	M-Node: Set to 1 to tell the client to act as a NetBIOS M-node.	P-Node	1/8 (1 bit)	P-Node: Set to 1 to tell the client to act as a NetBIOS P-node.	B-Node	1/8 (1 bit)	B-Node: Set to 1 to tell the client to act as a NetBIOS B-node.
Subfield Name	Size (bytes)	Description																		
Reserved	4/8 (4 bits)	Reserved: Not used.																		
H-Node	1/8 (1 bit)	H-Node: Set to 1 to tell the client to act as a NetBIOS H-node.																		
M-Node	1/8 (1 bit)	M-Node: Set to 1 to tell the client to act as a NetBIOS M-node.																		
P-Node	1/8 (1 bit)	P-Node: Set to 1 to tell the client to act as a NetBIOS P-node.																		
B-Node	1/8 (1 bit)	B-Node: Set to 1 to tell the client to act as a NetBIOS B-node.																		
47	Variable	NetBIOS Over TCP/IP Scope: Specifies the NetBIOS over TCP/IP scope parameter for the client.																		
48	Variable (Multiple of 4)	X Window System Font Servers: Specifies a list of IP addresses of X Window System Font servers that the client may use. Servers are listed in the order of preference for the client to use.																		
49	Variable (Multiple of 4)	X Window System Display Manager: Specifies a list of IP addresses of systems running the X Window System Display Manager that the client may use. Addresses are listed in the order of preference for the client to use.																		
64	Variable	Network Information Service+ Domain: Specifies the client's NIS+ domain. Contrast to option #40.																		

Table 198: DHCP/BOOTP Options: Application and Service Parameters (Page 3 of 3)

Code Value	Data Length (bytes)	Name and Description
65	Variable (Multiple of 4)	Network Information Service+ Servers: Specifies a list of IP addresses of NIS+ servers the client may use. Servers are listed in the order of preference for the client to use. Contrast to option #41.
68	Variable (Multiple of 4)	Mobile IP Home Agent: Specifies a list of IP addresses of home agents that the client can use in Mobile IP . Agents are listed in the order of preference for the client to use; normally a single agent is specified.
69	Variable (Multiple of 4)	Simple Mail Transport Protocol (SMTP) Servers: Specifies a list of IP addresses of SMTP servers the client may use. Servers are listed in the order of preference for the client to use.
70	Variable (Multiple of 4)	Post Office Protocol (POP3) Servers: Specifies a list of IP addresses of POP3 servers the client may use. Servers are listed in the order of preference for the client to use.
71	Variable (Multiple of 4)	Network News Transfer Protocol (NNTP) Servers: Specifies a list of IP addresses of NNTP servers the client may use. Servers are listed in the order of preference for the client to use.
72	Variable (Multiple of 4)	Default World Wide Web (WWW) Servers: Specifies a list of IP addresses of World Wide Web (HTTP) servers the client may use. Servers are listed in the order of preference for the client to use.
73	Variable (Multiple of 4)	Default Finger Servers: Specifies a list of IP addresses of Finger servers the client may use. Servers are listed in the order of preference for the client to use.
74	Variable (Multiple of 4)	Default Internet Relay Chat (IRC) Servers: Specifies a list of IP addresses of Internet Relay Chat (IRC) servers the client may use. Servers are listed in the order of preference for the client to use.
75	Variable (Multiple of 4)	StreetTalk Servers: Specifies a list of IP addresses of StreetTalk servers the client may use. Servers are listed in the order of preference for the client to use.
76	Variable (Multiple of 4)	StreetTalk Directory Assistance (STDA) Servers: Specifies a list of IP addresses of STDA servers the client may use. Servers are listed in the order of preference for the client to use.

DHCP Extensions

Last but certainly not least, [Table 199](#) describes the DHCP-only options that control the operation of the DHCP protocol.

Table 199: DHCP Options: DHCP Extensions (Page 1 of 2)

Code Value	Data Length (bytes)	Name and Description																		
50	4	Requested IP Address: Used in a client's <i>DHCPDISCOVER</i> message to request a particular IP address assignment.																		
51	4	IP Address Lease Time: Used in a client request to ask a server for a particular DHCP lease duration, or in a server reply to tell the client the offered lease time. It is specified in units of seconds.																		
52	1	<p>Option Overload: Used to tell the recipient of a DHCP message that the message's <i>SName</i> and/or <i>File</i> fields are being used to carry options, instead having their normal meanings. This option implements the option overload feature. There are three possible values for this single-byte option:</p> <table border="1"> <thead> <tr> <th>Option Value</th> <th>Option Overload Method</th> </tr> </thead> <tbody> <tr> <td>1</td> <td>The <i>File</i> field is carrying option data.</td> </tr> <tr> <td>2</td> <td>The <i>SName</i> field is carrying option data.</td> </tr> <tr> <td>3</td> <td>Both fields are carrying option data.</td> </tr> </tbody> </table>	Option Value	Option Overload Method	1	The <i>File</i> field is carrying option data.	2	The <i>SName</i> field is carrying option data.	3	Both fields are carrying option data.										
Option Value	Option Overload Method																			
1	The <i>File</i> field is carrying option data.																			
2	The <i>SName</i> field is carrying option data.																			
3	Both fields are carrying option data.																			
53	1	<p>DHCP Message Type: Indicates the specific type of DHCP message:</p> <table border="1"> <thead> <tr> <th>Option Value</th> <th>DHCP Message Type</th> </tr> </thead> <tbody> <tr> <td>1</td> <td><i>DHCPDISCOVER</i></td> </tr> <tr> <td>2</td> <td><i>DHCPOFFER</i></td> </tr> <tr> <td>3</td> <td><i>DHCPREQUEST</i></td> </tr> <tr> <td>4</td> <td><i>DHCPDECLINE</i></td> </tr> <tr> <td>5</td> <td><i>DHCPACK</i></td> </tr> <tr> <td>6</td> <td><i>DHCPNAK</i></td> </tr> <tr> <td>7</td> <td><i>DHCPRELEASE</i></td> </tr> <tr> <td>8</td> <td><i>DHCPINFORM</i></td> </tr> </tbody> </table>	Option Value	DHCP Message Type	1	<i>DHCPDISCOVER</i>	2	<i>DHCPOFFER</i>	3	<i>DHCPREQUEST</i>	4	<i>DHCPDECLINE</i>	5	<i>DHCPACK</i>	6	<i>DHCPNAK</i>	7	<i>DHCPRELEASE</i>	8	<i>DHCPINFORM</i>
Option Value	DHCP Message Type																			
1	<i>DHCPDISCOVER</i>																			
2	<i>DHCPOFFER</i>																			
3	<i>DHCPREQUEST</i>																			
4	<i>DHCPDECLINE</i>																			
5	<i>DHCPACK</i>																			
6	<i>DHCPNAK</i>																			
7	<i>DHCPRELEASE</i>																			
8	<i>DHCPINFORM</i>																			
54	4	Server Identifier: The IP address of a particular DHCP server. This option is included in messages sent by DHCP servers to identify themselves as the source of the message. It is also used by a client in a <i>DHCPREQUEST</i> message to specify which server's lease it is accepting.																		
55	Variable	Parameter Request List: Used by a DHCP client to request a list of particular configuration parameter values from a DHCP server.																		
56	Variable	Message: Used by a server or client to indicate an error or other message.																		

Table 199: DHCP Options: DHCP Extensions (Page 2 of 2)

Code Value	Data Length (bytes)	Name and Description
57	2	Maximum DHCP Message Size: Used by a DHCP client or server to specify the maximum size of DHCP message it is willing to accept. The minimum legal value is 576 bytes.
58	4	Renewal (T1) Time Value: Tells the client the value to use for its renewal timer .
59	4	Rebinding (T2) Time Value: Tells the client what value to use for its rebinding timer .
60	Variable	Vendor Class Identifier: Included in a message sent by a DHCP client to specify its vendor and configuration. This may be used to prompt a server to send the correct vendor-specific information using option #43.
61	Variable	Client Identifier: Used optionally by a client to specify a unique client identification for itself that differs from the DHCP default. This identifier is expected by servers to be unique amongst all DHCP clients and is used to index the DHCP server's configuration parameter database .
66	Variable	TFTP Server Name: When the DHCP message's <i>SName</i> field has been used for options using the option overload feature , this option may be included to specify the TFTP server name that would normally appear in the <i>SName</i> field.
67	Variable	Bootfile Name: When the DHCP message's <i>File</i> field has been used for options using the option overload feature , this option may be included to specify the bootfile name that would normally appear in the <i>File</i> field.



DHCP Client/Server Implementation, Features and Issues

The three preceding sections describe the DHCP [address leasing system](#), [configuration processes](#) and [messaging](#). Between them, these sections provide an explanation of all the fundamentals of the operation of DHCP. With this foundation in place, we can now proceed to look into some of the more interesting details of how DHCP is implemented. We can also delve into some of the extra capabilities and special features that change the basic DHCP mechanisms we have already studied.

In this section, I discuss DHCP client/server implementation issues, special features that enhance the protocol, and some of the problems and issues related to making DHCP work. I begin with a discussion of DHCP server and client implementation and management issues. I discuss DHCP message relaying and how it is related to the relaying feature used for BOOTP. I describe the DHCP feature for providing automatic default addressing when a client cannot contact a server, and the conflict detection feature for multiple servers. I then cover some of the issues related to interoperability of DHCP and BOOTP, and provide an outline of some of the more important problems and issues related to DHCP security.



Background Information: This section assumes that you are already familiar with the basic operation of DHCP. In particular, you should be sure that you have read through and understood [the section on DHCP operation](#) before proceeding.

DHCP Server General Implementation and Management Issues

DHCP is a client/server protocol, relying on both server and client to fulfill [certain responsibilities](#). Of the two device roles, the DHCP server is arguably the more important, because it is in the server that most of the functionality of DHCP is actually implemented. The server maintains the configuration database, keeps track of address ranges and manages leases. For this reason, DHCP servers are also typically much more **complex** than DHCP clients.

In essence, without a DHCP server, there really is no DHCP. Thus, deciding how to implement DHCP servers is a large part of implementing the protocol. This overall chapter is about describing the function of protocols like DHCP and not getting into details of how to implement them. However, I feel it is useful to look at some of the general issues related to how DHCP servers are set up and used, to help put into perspective how the protocol really works.

DHCP Server Implementations

A “classical” DHCP server consists of DHCP server software running on a server hardware platform of one sort or another. A DHCP server usually will not be a dedicated computer except on very large networks. It is more common for a hardware server to provide DHCP services along with performing other functions, such as acting as an application server,

general database server, providing [DNS](#) services and so forth. So, a DHCP server need not be a special computer; any device that can run a DHCP server implementation can act as a server.

In fact, the DHCP server may not even need to be a host computer at all. Today, many **routers** include DHCP functionality. Programming a router to act as a DHCP server allows clients that connect to the router to be automatically assigned IP addresses. This provides numerous potential advantages in an environment where a limited number of public IP addresses is shared amongst multiple clients, or where [IP Network Address Translation \(NAT\)](#) is used to dynamically share a small number of addresses. Since DHCP requires a database, a router that acts as a DHCP server requires some form of permanent storage. This is often implemented using flash memory on routers, while “true” servers of course use hard disk storage.

Virtually all modern operating systems include support for DHCP, including most variants of UNIX, Linux, newer versions of Microsoft Windows, Novell NetWare and others. In some cases, you may need to run the “server version” of the operating system to have a host act as a DHCP server. For example, while Microsoft Windows XP supports DHCP, I don't believe that a DHCP server comes in “Windows XP Home”, the “home user” version. (Of course, you could install one yourself!)

DHCP Server Software Features

In most networks you will choose the operating system based on a large number of factors. The choice of OS will then dictate what options you have for selecting DHCP server software. Most common operating systems have a number of options available for software. While all will implement the core DHCP protocol, they will differ in terms of the usual software attributes: cost, performance, ease of use and so. They may also differ in terms of their features, such as the following:

- ☉ How they allow [address ranges \(scopes\)](#) to be defined.
- ☉ How clients can be grouped and managed.
- ☉ The level of control an administrator has over parameters returned to a client.
- ☉ The level of control an administrator has over general operation of the protocol, such as specification of the [T1 and T2 timers](#) and other variables, and how leases are [allocated](#) and [renewals](#) handled.
- ☉ [Security features](#).
- ☉ Ability to interact with DNS to support dynamic device naming.
- ☉ Optional features such as [BOOTP support](#), [conflict detection](#), and [automatic private IP addressing](#).

Choosing the Number of Servers

In setting up DHCP for a network, there are a number of important factors to consider and decisions to be made. One of the most critical is the number of servers you want to have. In theory, each network requires only one DHCP server; in practice, this is often not a great

idea. Servers sometimes experience hardware or software failures, or have to be taken down for maintenance. If there is only one server and clients can't reach it, no DHCP clients will be able to get addresses. For this reason, two or more servers are often used.

If you do use more than one server, you have to carefully plan how you will configure each one. One of the first decisions you will need to make is which servers will be responsible for which addresses and clients. You have to determine whether you want the servers to have distinct or overlapping address pools, as discussed in [the topic on DHCP address ranges](#). Distinct pools ensure that addresses remain unique but result in unallocatable addresses if a server fails; overlapping addresses are more flexible, but risk address conflicts unless a feature like [conflict detection](#) is used.

Server Placement, Setup and Maintenance

Once you know how many servers you want, you have to determine on which part of the network you want to place them. If you have many physical networks, you may also need to use [DHCP relaying](#) to allow all clients to reach a server. Of course, the structure of the network may affect the number of servers you use, so many of these decisions are interrelated.

You must make policy decisions related to all the DHCP operating parameters we have seen earlier. The two biggies are deciding on the size and structure of the address pool, and making lease policy decisions such as [lease length](#) and the settings for the [T1 and T2 timers](#). You also must decide what clients will be dynamically allocated addresses and how [manually-configured clients](#) will be handled.

Finally, it's essential for the administrator to remember that an organization's DHCP server is a **database server** and must be treated accordingly. Like any database server, it must be maintained and managed carefully. Administrative policies must be put into place to ensure the security and efficient operation of the server. Also, unlike certain other types of database systems, the DHCP database is not automatically replicated; the server database should therefore be routinely backed up, and using RAID storage is also a good idea.

DHCP Client General Implementation and Management Issues

I said in the previous topic that without DHCP servers, there would be no DHCP, which is true. DHCP servers are where most of the protocol is implemented, so they are the heart of the protocol. With servers you have DHCP, but without **clients**, there's nothing to actually use DHCP, so nobody would even care. Thus, even though they are less critical than servers when viewed strictly from the point of view of the protocol, DHCP clients are still quite important.

Just as a DHCP server consists of server software running on a server platform or hardware acting as a server, a DHCP client is simply DHCP client software running on a client device. Most often, a client device is a host computer connected to a TCP/IP internetwork. DHCP is today so widely accepted that virtually all hosts include DHCP client software. The DHCP client is usually integrated into graphical operating systems like Windows, or is implemented using a specific client daemon like *dhclient* or *dhcpcd* on UNIX/Linux.

Since the entire idea behind DHCP is to put the server in charge of parameter storage, configuration and address management, DHCP clients are relatively simple. The client implements the messaging protocol and communicates parameters received from the DHCP server to the rest of the TCP/IP software components as needed. It doesn't do a whole lot else.

In fact, there's not really much for an administrator to do to set up a client to use DHCP. In some operating systems, it's as simple as "throwing a switch", by enabling DHCP support within the client itself. This prompts the client to then stop using any manually-configured parameters and start searching for a DHCP server instead. The server then becomes responsible for the client's configuration and address assignment.

Since the client doesn't do a great deal in DHCP other than communicate with the server, not much is required in the way of user software for a DHCP client. In most cases, control over the DHCP client software is accomplished using a [TCP/IP configuration utility](#). Windows clients use the programs *ipconfig* or *winiptcfg* to display the status of their current DHCP leases. These programs also allow the client to manually release the current lease or renew it.

Releasing the lease means [early lease termination](#) using the *DHCPRELEASE* message. This is usually the only way that a lease is terminated. Renewing the lease is a manual version of the automated renewal process. Releasing and renewing the lease may be done in sequence to reset a client that is in a confused state or is having some other type of DHCP or connectivity problem.

DHCP Message Relaying and BOOTP Relay Agents

DHCP is the third-generation host configuration protocol for TCP/IP. We've already seen extensively how it was based directly on the [Boot Protocol](#); BOOTP was in turn an enhancement of the earlier [Reverse Address Resolution Protocol \(RARP\)](#). Even though each new protocol has made significant improvements over its predecessor, each iteration has retained certain limits that are actually common to all host configuration protocols.

One of the most important limitations with host configuration protocols is the reliance on broadcasts for communication. Whenever we are dealing with a situation where a client needs to communicate but doesn't know its IP address and doesn't know the address of a server that will provide it, the client needs to use [broadcast addressing](#). However, for performance reasons, broadcasts are normally only propagated on the local network. This means that the client and server would always need to be on the same physical network for host configuration to occur. Of course, we don't want this to be the case. It would require that a large internetwork have a different server on every network, greatly reducing the benefits of centralized configuration information, and creating numerous administrative hassles.

Use of BOOTP Relay Agents for DHCP

RARP didn't have any solution to the problem of clients and servers on different networks, which is one reason why it was so limited in usefulness. BOOTP did: it allows a client and server to be on different networks through the use of BOOTP *relay agents*. A relay agent is

a device that is not a BOOTP server, but which runs a special software module that allows it to act in the place of a server. A relay agent can be placed on networks where there are BOOTP clients but no BOOTP servers. The relay agent intercepts requests from clients and relays them to the server. The server then responds back to the agent, which forwards the response to the client. A full rationale and description of operation of BOOTP relay agents can be found in [the topic discussing them](#).

The designers of DHCP were satisfied with the basic concepts and operation behind BOOTP relay agents, which had already been in use for many years. For this reason, they made the specific decision to continue using BOOTP relay agent functionality in DHCP. In fact, this is one of the reasons why the decision was made to retain the BOOTP message format in DHCP, and also the basic two-message “request/reply” communication protocol. This allows BOOTP relay agents to handle DHCP messages as if they are BOOTP messages.

This is also why the mention of BOOTP in the title of this topic is not a typo—DHCP in fact uses BOOTP relay agents. Even the DHCP standard says that a “BOOTP relay agent is an Internet host or router that passes DHCP messages between DHCP clients and DHCP servers.” In practice, the agents are indeed sometimes called “DHCP relay agents”; you may also see the mixed terms “BOOTP/DHCP relay agent” and “DHCP/BOOTP relay agent”.

DHCP Relaying Process

Since DHCP was designed specifically to support BOOTP relay agents, the agents behave in DHCP much as they do in BOOTP. Of course DHCP has much more complex message exchanges, but as we've already seen, they are all still designed around the notion of a client request and server response. There are just more requests and responses. The BOOTP agent looks for broadcasts sent by the client and then forwards them to the server [just as described in the topic on BOOTP relay agent behavior](#), and then returns replies from the server. The additional information in the DHCP protocol is implemented using additions to the BOOTP message format in the form of DHCP options, which the relay agent doesn't look at. It just treats them as it does BOOTP requests and replies.

So, in summary, when a relay agent is used, here's what the various client requests and server replies in the DHCP operation section become:

- ① **Client Request:** When a client broadcasts a request, the relay agent intercepts it on UDP port 67. It checks the *Hops* field, and discards the request if the value is greater than 16; otherwise it increments the field. The agent puts its own address into the *GIAddr* field unless another relay agent has already put its address in the field. It then forwards the client request to a DHCP server, either unicast or broadcast on another network.
- ② **Server Reply:** The server sees a non-zero value in *GIAddr* and sends the reply to the relay agent whose IP address is in that field. The relay agent then sends the reply back to the client, using either unicast or broadcast as discussed in [the topic on DHCP addressing](#).

One difference between BOOTP and DHCP is that certain communications from the client to the server are unicast. The most noticeable instance of this is when a client tries to renew its lease with a specific DHCP server. Since it sends this request unicast, it can go to a DHCP server on a different network using conventional IP routing, and the relay agent does not need to be involved.



Key Concept: To permit DHCP clients and DHCP servers to reside on different physical networks, an intermediary device is required to facilitate message exchange between networks. DHCP uses the same mechanism for this as BOOTP: the deployment of *BOOTP relay agents*. The relay agent captures client requests, forwards them to the server, and then returns the server's responses back to the client.

DHCP Autoconfiguration / Automatic Private IP Addressing (APIPA)

The IP address of a TCP/IP host is, in many ways, its identity. Every TCP/IP network requires that all hosts have unique addresses to facilitate communication. When a network is manually configured with a distinct IP address for each host, the hosts permanently know "who they are". When hosts are made DHCP clients, they no longer have a permanent identity; they rely on a DHCP server to tell them "who they are".

Client Recovery From Failure to Obtain an IP Address

The dependency of DHCP clients on servers is not a problem as long as DHCP is functioning normally and a host can get a lease, and in fact has many benefits that we have explored. Unfortunately, a number of circumstances can arise that result in one of the DHCP processes not resulting in a lease for the client. The client may not be able to obtain a lease, re-acquire one after reboot, or renew an existing lease. There are many possible reasons why this might happen:

- ☉ The DHCP server may have experienced a failure, or may be taken down for maintenance;
- ☉ The relay agent on the client's local network may have failed;
- ☉ Another hardware malfunction or power failure may make communication impossible;
- ☉ The network may have run out of allocatable addresses.

Without a lease, the host has no IP address, and without an address, the host is effectively dead in the water. The base DHCP specification doesn't really specify any recourse for the host in the event that it cannot successfully obtain a lease. It is essentially left up to the implementor to decide what to do, and when DHCP was first created, many host implementations would simply display an error message and leave the host unusable until an administrator or user took action.

Clearly this is far from an ideal situation. It would be better if we could just have a DHCP client that is unable to reach a server automatically configure itself. In fact, the IETF reserved a [special IP address block](#) for this purpose. This block, 169.254.0.1 through 169.254.255.254 (or 169.254.0.0/16 in classless notation) is reserved for autoconfiguration, as mentioned in RFC 3330:

“Hosts obtain these addresses by auto-configuration, such as when a DHCP server may not be found.”

Strangely, however, no TCP/IP standard was defined to specify how such autoconfiguration works. To fill the void, Microsoft created an implementation that it calls *Automatic Private IP Addressing (APIPA)*. Due to Microsoft's market power, APIPA has been deployed on millions of machines, and has thus become a de facto standard in the industry. Many years later, the IETF did define a formal standard for this functionality, in RFC 3927, *Dynamic Configuration of IPv4 Link-Local Addresses*.

APIPA Operation

APIPA is really so simple that it's surprising it took so long for someone to come up with the idea. It takes over at the point where any DHCP lease process fails. Instead of just halting with an error message, APIPA randomly chooses an address within the aforementioned private addressing block. It then performs a test very similar to the one in step #13 in [the DHCP allocation process](#): it uses ARP to generate a request on the local network to see if any other client responds using the address it has chosen. If there is a reply, APIPA tries another random address and repeats the test. When the APIPA software finds an address that is not in use, it is given to the client as a default address. The client will then use default values for other configuration parameters that it would normally receive from the DHCP server. This process is illustrated in [Figure 269](#).

A client using an autoconfigured address will continue to try to contact a DHCP server periodically. By default, this check is performed every five minutes. If and when it finds one, it will obtain a lease and replace the autoconfigured address with the proper leased address.

APIPA is ideally suited to small networks, where all devices are on a single physical link. Conceivably, with 20 APIPA-enabled DHCP clients on a network with a single DHCP server, you could take the server down for maintenance and still have all the clients work properly, using 169.254.x.x addresses.

APIPA Limitations

Bear in mind that APIPA is not a proper replacement for full DHCP. The 169.254.0.0/16 block is a private IP range and comes with all [the limitations of private IP addresses](#), including inability to use these addresses on the Internet. Also, APIPA cannot provide the other configuration parameters that a client may need to get from a DHCP server. Finally, APIPA will not work properly in conjunction with [proxy ARP](#), because the proxy will respond for any of the private addresses, so they will all appear to be used.

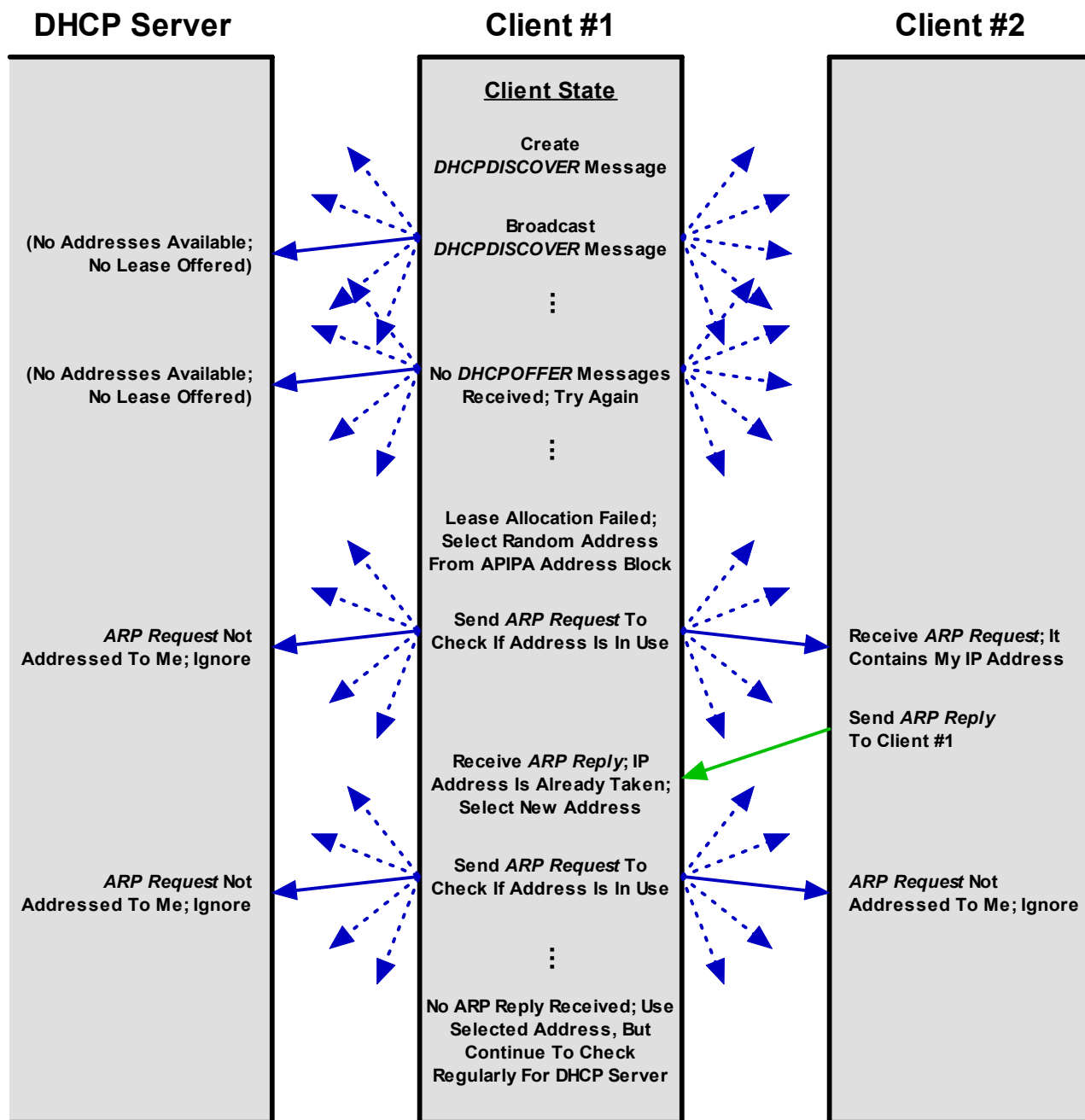

Figure 269: DHCP Automatic Private IP Addressing (APIPA)

In this example, Client #1 is trying to get an IP address from its DHCP server, but the server is out of addresses, so it does not respond to the client's requests. The client is configured to use APIPA, so it randomly selects an address from the APIPA address block. It sends an *ARP Request* on the local network to see if any other device is using that address; in this case, Usually there will be no conflict, but here Client #2 is in fact using the address, so it responds. Client #1 chooses a different address and this time gets no reply. It begins using that address, while continuing to check regularly for a DHCP server to come online.

Since it uses ARP to check for address conflicts, APIPA is not well-suited for large internetworks. To use it on an internetwork with multiple subnets, you would require software that allows each subnet to use a different portion of the full 169.254.0.0/16 blocks, to avoid

conflicts. In practice, APIPA is a solution for small networks; large internetworks deal with the problem of not being able to contact a DHCP server by making sure that a client can always contact a DHCP server. ☺



Key Concept: An optional DHCP feature called Automatic Private IP Addressing (APIPA) was developed to allow clients to still be able to communicate in the event that they are unable to obtain an IP address from a DHCP server. When enabled, the client chooses a random address from a special reserved block of private IP addresses, and checks to make sure the address is not already in use by another device. It continues to check for a DHCP server periodically until it is able to find one.

DHCP Server Conflict Detection

As we saw in [the first topic of this section](#), one of the primary decisions any TCP/IP administrator using DHCP must make is how many DHCP servers to deploy. A single server has the advantage of simplicity, but provides no redundancy in the event of failure. It also means that whenever the DHCP server is down, clients can't get addresses. For these reasons, most larger networks use two or more servers.

The Need to Prevent Duplicate Assignment of the Same Address

When you have two servers or more—and let's just say two for sake of this discussion—you then have another decision to make: how do you divide the address pool between the servers? As I explored in detail in [the discussion of DHCP address pools](#), there are two options: either giving the servers overlapping addresses, or making them non-overlapping. Unfortunately, in classical DHCP, neither is really a great solution. Overlapping ranges mean both servers might try to assign the same address, since DHCP includes no provision for communication between servers. Non-overlapping ranges avoids this problem, but makes only some of the addresses available to each server.

It's strange that the DHCP standard didn't provide better support for cross-server coordination, even though there clearly was a need for it. However, certain DHCP implementations implement an optional feature to in fact allow two servers to have overlapping scopes without address clashes occurring. Again, this is a feature commonly found on Microsoft DHCP servers, and may also be present in other implementations. It is called *DHCP server conflict detection*.

Conflict Detection Operation

The idea behind conflict detection is very simple. Suppose a DHCP server receives a *DHCPDISCOVER* message from a client and decides to offer it a lease. Before sending the *DHCPOFFER* message, the server conducts a *probe* by sending [ICMP Echo \(ping\) messages](#) out to the address it plans to offer. It then waits a short period of time to hear if it receives any [ICMP Echo Reply messages](#) back. If it does, it knows the IP address is in use and chooses a different one.

If all DHCP servers are configured to do this before offering an address, then it is possible to give all of them the same, overlapping addresses for assignment. They won't have any way of coordinating with each other, but as long as they “ask first” by doing an ICMP check, there won't be any problems. This provides an administrator with the advantages of overlapping address ranges—simplicity and access to all addresses by all servers—without risk of address conflicts. The only small drawback is a little bit of extra network traffic to perform the check, and possibly a few milliseconds of server CPU time if a new address needs to be chosen.

If you were paying attention when you read about the DHCP allocation process, you may have noticed that what I am describing here sounds familiar. In fact, it's true: this feature really isn't anything new. The use of ICMP to check an address before offering it is actually mentioned in RFC 2131 as part of the standard DHCP allocation process, and you can find it mentioned as step #5 in [the allocation process](#) in this Guide.

So why was “conflict detection” required to be an extra feature? Simple: the use of ICMP wasn't mandatory because the standard says servers **SHOULD** do it and not that they **MUST** do it. That's why they capitalize those words in the standards. ☺ This choice was made to provide flexibility in implementing DHCP, but that flexibility comes at a cost. So, if you want to use this feature, you need to look for support for it in your server software.



Key Concept: Some DHCP implementations include a feature called *server conflict detection*. When this feature is activated, it causes each server to always check to make sure an address is not in use before granting it to a client. When conflict detection is used by all DHCP servers on a network, the servers can be given overlapping scopes, so each can assign any of the organization's IP addresses, while at the same time not needing to be concerned about two clients being assigned the same address by different servers.

DHCP and BOOTP Interoperability

I've talked extensively about how DHCP was designed based on the [Boot Protocol](#), and how they use the same basic communication method and message format. This was done for several reasons, one of the most important of which was ensuring interoperability of the two protocols. Given this, you might expect that we could simply say that BOOTP and DHCP are compatible with each other, and that's that. Then again, given that you can see I have a whole topic on the subject, maybe you wouldn't think that at all...

It is in fact true that DHCP was intended to be compatible with BOOTP. RFC 2131 lists the following as one of DHCP's design goals: “DHCP must provide service to existing BOOTP clients.”. This seems pretty clear. The “reuse” of the [BOOTP message format](#) is one of the keys to DHCP and BOOTP compatibility. DHCP functionality is implemented not through new fields but rather through DHCP-specific options, such as the *DHCP Message Type* option that specifies the all important type of DHCP messages. DHCP devices can look for this extra information, while BOOTP devices can ignore it.

However, while DHCP and BOOTP are similar, they are not the same, and so there are some interoperability concerns that crop up when they are used together. The DHCP message format is structurally the same as the BOOTP format, but the interpretation of certain fields is slightly different. BOOTP clients don't understand DHCP, so when BOOTP and DHCP are used together, the DHCP client or server must sometimes behave slightly differently to compensate. Further complicating matters is the fact that not all implementations of DHCP and BOOTP are necessarily exactly the same, and the fact that certain specifications in the DHCP standard are not mandatory.

For these reasons, we cannot just assume that DHCP and BOOTP will work together. To address some of these issues, the IETF published RFC 1534, *Interoperation Between DHCP and BOOTP*, at the same time that DHCP was originally created. This document looks at how the protocols work together, focusing on the two distinct client/server interoperating combinations: a BOOTP client connecting to a DHCP server, and a DHCP client connecting to a BOOTP server. Let's consider each case one at a time.

BOOTP Clients Connecting to a DHCP Server

As indicated by the quote above from RFC 2131, DHCP was specifically intended to allow a DHCP server to handle requests from BOOTP clients. The protocol itself is set up to enable this, but it does require that the DHCP server be given certain intelligence to know how to deal with BOOTP clients. One of the most important issue is, of course, that BOOTP clients will follow the [BOOTP configuration process](#) and not the [DHCP leasing processes](#). The DHCP server must use BOOTP messages with the BOOTP meanings for fields when dealing with BOOTP clients. A server determines that a client is using BOOTP instead of DHCP by looking for the presence of the *DHCP Message Type option*, which must be present in all DHCP messages but of course is not used for BOOTP.

If a DHCP server detects that it is dealing with a BOOTP client, it can respond with configuration information for the client. The server can use either [manual or automatic allocation](#) for the client. Automatic allocation of course means the server chooses an address from its pool of unused addresses, but assigns it permanently. BOOTP clients are not capable of dynamic allocation since BOOTP is static in nature.

A DHCP server may include [BOOTP vendor information fields](#) in its response to a BOOTP client, including ones defined since BOOTP was created. However, it obviously must not send any DHCP-specific options.

DHCP Clients Connecting to a BOOTP Server

Now, for the other case. A DHCP client can obtain configuration information from a BOOTP server, because the server will respond to the client's initial *DHCPDISCOVER* message as if it were a BOOTP *BOOTREQUEST* message. The DHCP client can tell that a BOOTP reply has been received because there will be no *DHCP Message Type* option. A response from a BOOTP server should be treated as an infinite lease, since again, that's all that BOOTP supports. Note that if a DHCP client receives a response from both a BOOTP server and a DHCP server, it should use the DHCP response and not the BOOTP response (even if this means it gets a shorter lease).

DHCP Security Issues

DHCP was designed in the early 1990s, when the number of organizations on the Internet was relatively small. Furthermore, it was based on BOOTP, which was created in the 1980s when the Internet as we know it today barely even existed. In those days, Internet security wasn't a big issue, because it was mostly a small group of research and educational organizations using TCP/IP on the Internet. As a result, DHCP, like many protocols of that era, doesn't do much to address security concerns.

Actually, this is a bit understated. Not only does DHCP run over IP and UDP, which are inherently insecure, the DHCP protocol itself has in fact *no* security provisions whatsoever. This is a fairly serious issue in modern networks, because of the sheer power of DHCP: the protocol deals with critical configuration information. There are two different classes of potential security problems related to DHCP:

- ① **Unauthorized DHCP Servers:** If a malicious person plants a “rogue” DHCP server, it is possible that this device could respond to client requests and supply them with spurious configuration information. This could be used to make clients unusable on the network, or worse, set them up for further abuse later on. For example, a hacker could exploit a bogus DHCP server to direct a DHCP client to use a router under the hacker's control, rather than the one the client is supposed to use.
- ② **Unauthorized DHCP Clients:** A client could be set up that masquerades as a legitimate DHCP client and thereby obtain configuration information intended for that client; this could then be used to compromise the network later on. Alternately, a “bad guy” could use software to generate lots of bogus DHCP client requests to use up all the IP addresses in a DHCP server's pool. More simply, this could be used by a thief to steal an IP address from an organization for his own use.

Adding Security to DHCP

These are obviously serious concerns. The normal recommended solutions to these risks generally involve providing security at lower layers. For example, one of the most important techniques for preventing unauthorized servers and clients is careful control over physical access to the network: layer one security. Security techniques implemented at layer two may also be of use, for example, in the case of wireless LANs. Since DHCP runs over UDP and IP, one could use [IPSec](#) at layer three to provide authentication.

DHCP Authentication

To try to address some of the more specific security concerns within DHCP itself, in June 2001 the IETF published RFC 3118, [Authentication for DHCP Messages](#). This standard describes an enhancement that replaces the normal DHCP messages with authenticated ones. Clients and servers check the authentication information and reject messages that come from invalid sources. The technology involves the use of a new DHCP option type, the *Authentication* option, and operating changes to several of the leasing processes to use this option.

Unfortunately, 2001 was pretty late in the DHCP game, and there are millions of DHCP clients and servers around that don't support this new standard. Both client and server must be programmed to use authentication for this method to have value. A DHCP server that supports authentication could use it for clients that support the feature and skip it for those that do not. However, the fact that this option is not universal means that it is not widely deployed, and most networks must rely on more conventional security measures.



DHCP For IP Version 6 (DHCPv6)

DHCP is currently the standard host configuration protocol for the TCP/IP protocol suite. TCP/IP is built upon version 4 of the Internet Protocol, also known sometimes as *IPv4*. However, development work has been underway since the early 1990s on a successor to IPv4: version 6 of the Internet Protocol, or *IPv6*. This new IP standard will be the future of TCP/IP; it is described in detail in [its own section of this Guide](#).

While most of the changes that IPv6 brings impact technologies at the lower layers of the TCP/IP architectural model, the significance of the modifications means that many other TCP/IP protocols are also affected. This is particularly true of protocols that work with addresses or configuration information, including DHCP. For this reason, a new version of DHCP is required for IPv6. Development has been underway for quite some time on *DHCP For IPv6*, also sometimes called *DHCPv6*. At the time that I write this topic, DHCPv6 has not yet been formally published—it is still an Internet draft under discussion. I will provide a summary of the protocol here, and may expand this into a larger section later.



Note: In discussions purely oriented around IPv6, DHCPv6 is sometimes just called “DHCP”, and the original DHCP is called “DHCPv4”, so watch out for that! For obvious reasons, I am not going to do that here.

Two Methods for Autoconfiguration in IPv6

One of the many enhancements introduced in IPv6 is an overall strategy for easier administration of IP devices, including host configuration. There are two basic methods defined for autoconfiguration of IPv6 hosts:

- ☉ **Stateless Autoconfiguration:** A method defined to allow a host to configure itself without help from any other device.
- ☉ **“Stateful” Autoconfiguration:** A technique where configuration information is provided to a host by a server.

Which of these methods is used depends on the characteristics of the network. Stateless autoconfiguration is described in RFC 2462, and discussed in [a separate topic in the IPv6 section](#). “Stateful” autoconfiguration for IPv6 is provided by DHCPv6. As with regular DHCP, DHCPv6 may be used to obtain an IP address and other configuration parameters, or just to get configuration parameters when the client already has an IP address.

DHCPv6 Operation Overview

The operation of DHCPv6 is similar to that of DHCPv4, but the protocol itself has been completely rewritten. It is not based on the older DHCP or on BOOTP, except in conceptual terms. It still uses UDP but uses new port numbers, a new message format, and restructured options. All of this means that the new protocol is not strictly compatible with DHCPv4 or BOOTP, though I believe work is underway on a method to allow DHCPv6 servers to work with IPv4 devices.



Key Concept: Since DHCP works with IP addresses and other configuration parameters, the change from IPv4 to IPv6 requires a new version of DHCP commonly called *DHCPv6*. This new DHCP represents a significant change from the original DHCP, and is still under development. DHCPv6 is used for IPv6 “*stateful*” *autoconfiguration*; the alternative is *stateless autoconfiguration*, a feature of IPv6 that allows a client to determine its IP address without need for a server.

DHCPv6 is also oriented around IPv6 methods of addressing, especially the use of [link-local scoped multicast addresses](#). This allows efficient communication even before a client has been assigned an IP address. Once a client has an address and knows the identity of a server it may communicate with the server directly using unicast addressing.

DHCP Message Exchanges

There are two basic client/server message exchanges that are used in DHCPv6: the *four-message exchange* and the *two-message exchange*. The former is used when a client needs to obtain an IPv6 address and other parameters. This process is similar to [the regular DHCP address allocation process](#); highly simplified, it involves these steps:

1. The client sends a multicast *Solicit* message to find a DHCPv6 server and ask for a lease.
2. Any server that can fulfill the client's request responds to it with an *Advertise* message.
3. The client chooses one of the servers and sends a *Request* message to it asking to confirm the offered address and other parameters.
4. The server responds with a *Reply* message to finalize the process.

There is also a shorter variation of the four-message process above, where a client sends a *Solicit* message and indicates that a server should respond back immediately with a *Reply* message.

If the client already has an IP address, either assigned manually or obtained in some other way, a simpler process can be undertaken, similar to [how in regular DHCP](#) the *DHCPINFORM* message is used:

1. The client multicasts an *Information-Request* message.
2. A server with configuration information for the client sends back a *Reply* message.

As in regular DHCP, a DHCPv6 client renews its lease after a period of time by sending a *Renew* message. DHCPv6 also supports [relay agent functionality](#) as in DHCPv4.



TCP/IP Network Management Framework and Protocols (SNMP and RMON)

Modern networks and internetworks are larger, faster and more capable than their predecessors of years gone by. As we expand, speed up and enhance our networks, they become more complex, and as a result, more difficult to manage. Where years ago an administrator could get by with very simple tools to keep a network running, today this is simply insufficient. More sophisticated network management technologies are required to match the sophistication of our networks.

Some of the most important tools in the network manager's "toolbox" are now in fact software, not hardware. To manage a sprawling, heterogeneous and complex internetwork, software applications have been developed that allow information to be gathered and devices controlled using the internetwork itself. TCP/IP, being the most popular internetworking suite, of course has such software tools. One of the most important is a pair of protocols that have been implemented as part of an overall method of network management called the *TCP/IP Internet Standard Management Framework*.

In this section I describe in detail the TCP/IP Internet Standard Management Framework, looking at each of its architectural and protocol components and how they interoperate. The first subsection provides an overview of the network management framework itself and serves as an introduction to the sections that follow. The second subsection discusses the way that network management information is structured and arranged into information stores called Management Information Bases (MIBs). The third subsection describes the operation of the key protocol in TCP/IP network management, the Simple Network Management Protocol (SNMP). Finally, I round out the section with a brief look at Remote Network Monitoring (RMON), an enhancement of SNMP—sometimes called a protocol, even though it really isn't—that provides administrators with greater management and monitoring abilities on a TCP/IP internetwork.



Note: While you may be tempted to jump straight to the subsection on SNMP, what is written there will make a *lot* more sense if you read the subsections here in order.

TCP/IP Internet Standard Management Framework Overview, Architecture, Components and Concepts

TCP/IP network management functions are most commonly associated with the key protocol responsible for implementing those functions: the *Simple Network Management Protocol (SNMP)*. Many people have heard of SNMP, and it is common for SNMP to be considered “the” way that network management is performed in TCP/IP.

This is true to an extent, but is really an oversimplification. The actual SNMP protocol is only one part of a higher-level network management strategy called the *Internet Standard Management Framework*. In order to really understand how SNMP works, we need to first have some background on the way this network management is structured as a whole.

In this section I provide an introduction to TCP/IP network management by describing the concepts and components of the TCP/IP Internet Standard Management Framework. I begin with an overview and history of the framework, and discuss how it is related to the Simple Network Management Protocol (SNMP). I describe the TCP/IP network management model and the key components that comprise a network management system. I provide a summary of the architecture of the Internet Standard Management Framework. I then describe the three main versions of the Framework and SNMP, and how they are similar and different. I conclude with a discussion of the many standards used to describe this technology.

Overview and History of the TCP/IP Internet Standard Management Framework and Simple Network Management Protocol (SNMP)

An adage from the world of professional sports says that a baseball umpire is doing a good job when you forget that he is there. In many ways, the same could be said of a network administrator. The administrator is doing a good job when the network is running so smoothly and efficiently that users forget that the administrator exists. Because as the administrator knows all too well, the second there is a problem, the users will all remember that he or she is there very quickly. ☺

This means that a primary job of a network administrator is to keep tabs on the network and ensure that it is operating normally. Information about the hardware and software on the network is a key to performing this task properly. When networks were small, an administrator could stay informed about the status of hardware and software using simple means, such as physically walking over to a computer and using it, or using a low-level link layer management protocol.

This is simply not possible with modern internetworks, which are large, geographically diverse, and often consist of many different lower-layer technologies. Usually, the only thing all the devices on the network have in common is an implementation of a particular internetworking protocol suite, such as TCP/IP. This makes the internetwork itself a logical way to facilitate the communication of network management information between devices and a network administrator.

Early Development of SNMP

Many people recognized during the early days of the Internet that some sort of network management technology would be needed for TCP/IP. Unfortunately, at first there was no single standard—in the 1980s, several different technologies were developed by different working groups. There were three main contestants: the *High-level Entity Management System (HEMS) / High-level Entity Management Protocol (HEMP)* as defined by RFCs 1021 through 1024; the *Simple Gateway Monitoring Protocol (SGMP)*, defined by RFC 1028; and the *Common Management Information Protocol (CMIP)*, which is actually part of the OSI protocol suite.

The [Internet Engineering Task Force \(IETF\)](#) recognized the importance of having a unifying management standard for TCP/IP, and in 1988 published RFC 1052, *IAB Recommendations for the Development of Internet Network Management Standards*. This memo is not a standard, but more of a statement of intention and documentation of a meeting held on this subject. The conclusion of RFC 1052 was that SGMP be used as the basis of a new Internet standard to be called the *Simple Network Management Protocol (SNMP)*. This development was to be carried out by the *SNMP Working Group*.

The Two Meanings of "SNMP"

The rationale of the middle two words in the name “Simple Network Management Protocol” is obvious, but the other two words are slightly more problematic. ☺ The word “Protocol” implies that SNMP is just a TCP/IP communication protocol, like other protocols such as [DHCP](#) or [FTP](#). Unfortunately, this is both true and untrue: the term “SNMP” is ambiguous.

At a lower level, SNMP does indeed refer specifically to the actual protocol that carries network management information between devices. This is in fact what most people think of when they talk about “SNMP”. However, as defined by the SNMP working group, the TCP/IP network management solution as a whole consists of a number of different elements arranged in an architecture.

This architecture originally had no specific name, but is now called the *Internet Standard Management Framework*. Oddly, this higher-level framework is not abbreviated “ISMF” or anything like that; it is **also** called “SNMP”, which means that context is important in understanding that term.



Note: To avoid confusion, I will often use the phrases “SNMP Framework” and “SNMP Protocol” to differentiate these two uses of the term “SNMP”.

Design Goals of SNMP

The word “Simple” in “Simple Network Management Protocol” is another sore spot for me; having researched and written about this technology, I now consider the presence of this term in the name “SNMP” to be almost a taunt. Let's put it this way: if a brain surgeon tells

you that something is a “simple procedure”, you probably know to take that with a grain of salt—well, the same applies here. Even in its first iteration it was only somewhat simple; the most current version of SNMP is fairly complicated indeed, with many different standards defining the SNMP Framework, the SNMP Protocol itself, and a number of supporting elements.

So why is it called “simple”? Well, as they say, everything's relative; SNMP is “simple” when compared to other protocols that are even more complex. Some of this can be seen by looking at the basic goals of the Internet Standard Management Framework and the SNMP protocol as a whole:

- SNMP defines a universal way that management information can be easily defined for any object and then exchanged between that object and a device designed to facilitate network management;
- SNMP separates the functions of defining and communicating management information from the applications that are used for network management;
- The actual SNMP protocol is fairly simple, consisting of only a few easy-to-understand protocol operations;
- The implementation of SNMP is relatively simple for the designers and manufacturers of products.

Since SNMP is a TCP/IP application layer protocol, it can theoretically run over a variety of transport mechanisms. It is most commonly implemented over IP, of course, but the most recent versions also define *transport mappings* that can allow SNMP information to be carried over other internetworking technologies. Again, my focus will continue to be almost exclusively on TCP/IP.



Key Concept: The *Simple Network Management Protocol (SNMP)* defines a set of technologies that allows network administrators to remotely monitor and manage TCP/IP network devices. The term “SNMP” refers both to a specific communication protocol (sometimes called the *SNMP Protocol*) and an overall framework for Internet management (the *SNMP Framework*).

Further Development of SNMP and the Problem of SNMP Variations

The description above provides the history of how the first version of SNMP was developed, leading to the publishing of the first Internet Standard Management Framework in 1988; this is now called *SNMP version 1 (SNMPv1)*. This initial version of SNMP achieved widespread acceptance, and it is still probably the most common version of SNMP.

Much of the history of SNMP since that time has been a rather confusing “standards nightmare”. SNMPv1 had a number of weaknesses, particularly in the area of security. For this reason, shortly after SNMPv1 was done, work began on a new version of SNMP. Unfor-

tunately, this effort became a quagmire, with many competing variations of SNMPv2 being created. After many years of confusion, none of the SNMPv2 variants achieved significant success.

Recently, a third version of the SNMP Framework and Protocol has been published, which adds new features and “reunites” SNMP back under a single universal protocol again. The topics on [SNMP versions](#) and [SNMP standards](#) later in this section further explore the history of SNMP since 1988; they can be considered a continuation of this topic, as they help clarify the very confusing story behind SNMP versions over the last decade and a half.

This overview may have put more questions in your mind about the Internet Standard Management Framework and SNMP than it answered. This is part of why I said this stuff isn't really that simple. ☺ The next two topics in this section provide more information about the Framework and its components, and what those components do, so you can understand better what the Framework is all about.



Related Information: More background on the SNMP protocol proper can be found in [the overview topic on the actual protocol itself](#).

TCP/IP SNMP Operational Model, Components and Terminology.

So, it seems the “Simple” Network Management Protocol (SNMP) isn't quite so simple after all. There are many versions and standards and uses of SNMP, and so a lot we need to learn. I think a good place to start in understanding what SNMP does is to look at its *model of operation*, and examine the components that comprise a TCP/IP network management system and the terminology used to describe them.

SNMP Device Types

As we saw in the preceding [high-level overview topic](#), the overall idea behind SNMP is to allow the information needed for network management to be exchanged using TCP/IP. More specifically, the protocol allows a network administrator to make use of a special network device that interacts with other network devices to collect information from them, and modify how they operate. In the simplest sense, then, two different basic types of hardware devices are defined:

- ☉ **Managed Nodes:** Regular nodes on a network that have been equipped with software to allow them to be managed using SNMP. These are, generally speaking, conventional TCP/IP devices; they are also sometimes called *managed devices*.
- ☉ **Network Management Station (NMS):** A designated network device that runs special software to allow it to manage the regular managed nodes mentioned just above. One or more NMSes must be present on the network, as these devices are the ones that really “run” SNMP.

SNMP Entities

Each device that participates in network management using SNMP runs a piece of software, generically called an *SNMP entity*. The SNMP entity is responsible for implementing all of the various functions of the SNMP protocol. Each entity consists of two primary software components. Which components comprise the SNMP entity on a device depends of course on whether the device is a managed node or a network management station.

Managed Node Entities

An SNMP managed node can be pretty much any network device that can communicate using TCP/IP, as long as it is programmed with the proper SNMP entity software. SNMP is designed to allow regular hosts to be managed, as well as intelligent network interconnection devices such as routers, bridges, hubs and switches. Other “unconventional” devices can likewise be managed, as long as they connect to a TCP/IP internetwork: printers, scanners, consumer electronic devices, even specialty medical devices and more.

The SNMP entity on a managed node consists of the following software elements and constructs:

- ① **SNMP Agent:** A software program that implements the SNMP protocol and allows a managed node to provide information to an NMS and accept instructions from it.
- ② **SNMP Management Information Base (MIB):** Defines the types of information stored about the node that can be collected and used to control the managed node. Information exchanged using SNMP takes the form of objects from the MIB.

Network Management Station Entities

On a larger network, a network management station may be a separate, high-powered TCP/IP computer dedicated to network management. However, it is really software that makes a device into an NMS, so the NMS may not be a separate hardware device. It may act as an NMS and also perform other functions on the network.

The SNMP entity on a network management station consists of:

- ① **SNMP Manager:** A software program that implements the SNMP protocol, allowing the NMS to collect information from managed nodes and to send instructions to them.
- ② **SNMP Applications:** One or more software applications that allow a human network administrator to use SNMP to manage a network.

SNMP Terminology Summary

So, to integrate and reiterate all of this, let's summarize. SNMP consists of a small number of network management stations (NMSes) that interact with regular TCP/IP devices that are called managed nodes. The SNMP manager on the NMS and the SNMP agents on the managed nodes implement the SNMP protocol and allows network management infor-

mation to be exchanged. SNMP applications run on the NMS and provide the interface to the human administrator, and allow information to be collected from the MIBs at each SNMP agent, as shown in [Figure 270](#). Simple! See, the name is good after all. 😊

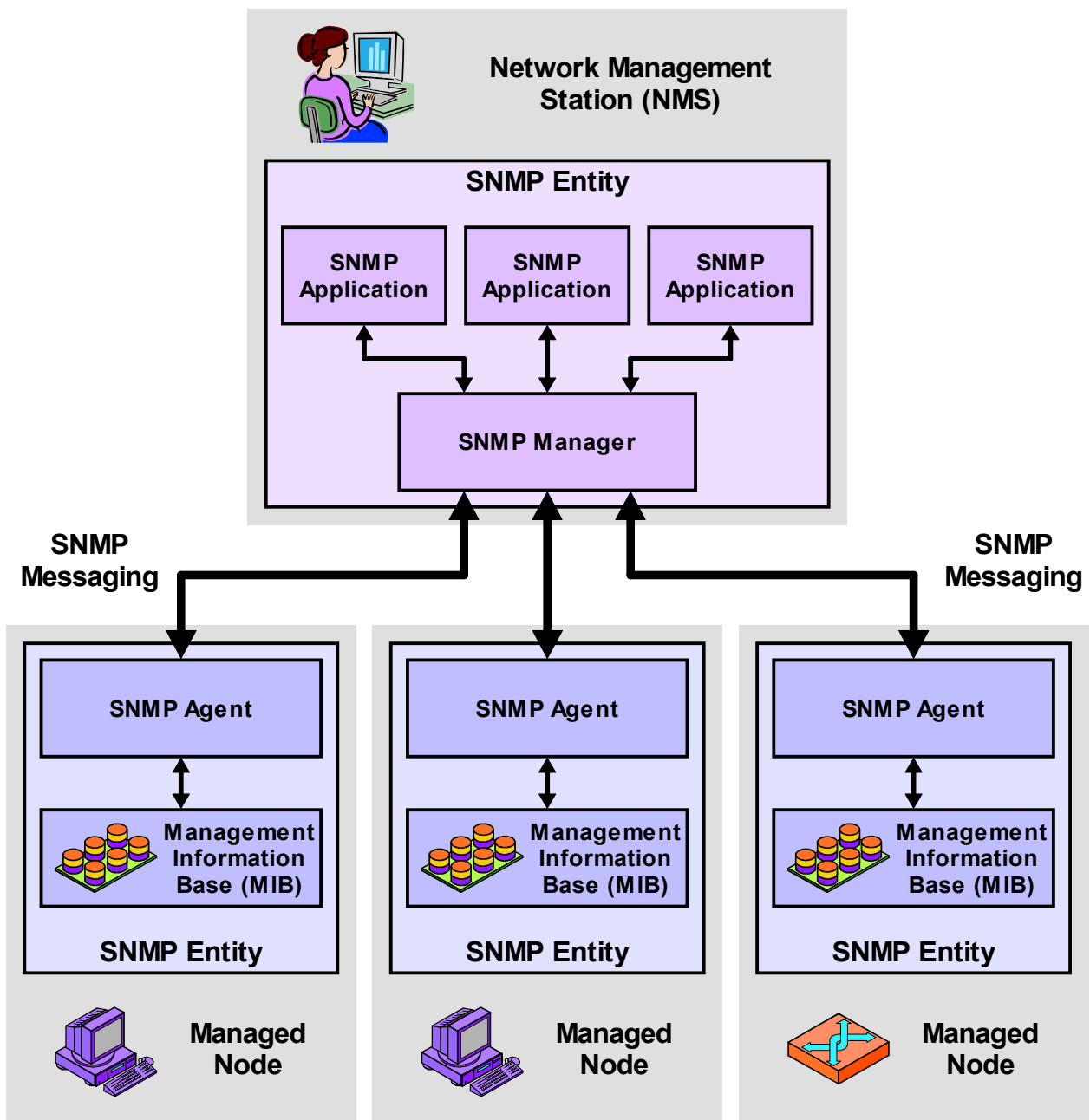

Figure 270: SNMP Operational Model

This diagram shows a simplified implementation of SNMP, with one network management station used to maintain three managed nodes. Each device has an *SNMP Entity*, and they communicate using SNMP messages. The SNMP entity of the NMS consists of the *SNMP Manager* and one or more *SNMP Applications*; the managed nodes each run an *SNMP Agent* and maintain a *Management Information Base (MIB)*.



Key Concept: SNMP allows a network administrator using a *network management station (NMS)* to control a set of *managed nodes*. Each device incorporates an *SNMP entity* that implements the technology. In an NMS, the entity consists of an *SNMP manager* module and a set of *SNMP applications*; in a managed node, an *SNMP agent* and *management information base (MIB)*.

TCP/IP Internet Standard Management Framework Architecture and Protocol Components

TCP/IP network management is based on the Simple Network Management Protocol, abbreviated SNMP. As we saw in [the overview topic](#), however, this term is ambiguous. While it is commonly used to refer to [the actual communication protocol](#) used to exchange network management information, the term also refers to the entire set of technologies that enable TCP/IP network management. The technical name for this larger architecture is the *Internet Standard Management Framework*. Again, even though it may seem strange, this term is actually abbreviated in the standards as “SNMP”. For simplicity, I abbreviate it as the “SNMP Framework”, to differentiate it from the SNMP protocol.

The Internet Standard Management Framework encompasses all of the technologies that comprise the TCP/IP network management solution. The SNMP Framework consists of a number of architectural components that define how management information is structured, how it is stored, and how it is exchanged using the SNMP protocol. The Framework also describes how the different components fit together, how SNMP is to be implemented in network devices, and how the devices interact.

SNMP Framework Components

As we will explore in more detail later, the Internet Standard Management Framework is entirely *information-oriented*. It includes the following primary components (see [Figure 271](#)):

- ☉ **Structure of Management Information (SMI):** To ensure interoperability of various devices, we want to have a consistent way of describing the characteristics of devices to be managed using SNMP. In computer science, a *data description language (DDL)* is the tool for this job. The *Structure of Management Information (SMI)* is a standard that defines the structure, syntax and characteristics of management information in SNMP.
- ☉ **Management Information Bases (MIBs):** Each managed device contains a set of variables that is used to manage it. These variables represent information about the operation of the device that is sent to a network management station, and/or parameters sent to the managed device to control it. The *management information base (MIB)* is the full set of these variables that describe the management characteristics of a particular type of device.

Each variable in a MIB is called a *MIB object*, and is defined using the SMI data description language. A device may have many objects, corresponding to the different

hardware and software elements it contains. Initially, a single document defined the MIB for SNMP, but this model was inflexible. To allow new MIB objects to be more easily defined, groups of related MIB objects are now defined in separate RFC standards called *MIB modules*. Over 100 such MIB modules have been defined so far.

- **Simple Network Management Protocol (SNMP):** This is the actual SNMP protocol itself. It defines how information is exchanged between SNMP agents and network management stations. The SNMP *protocol operations* define the various SNMP messages and how they are created and used. SNMP *transport mappings* describe how SNMP can be used over various underlying internetworks, such as TCP/IP, IPX and others.
- **Security and Administration:** To the three main architectural components above, the SNMP Framework adds a number of supporting elements. These provide enhancements to the operation of the SNMP protocol for security, and address issues related to SNMP implementation, version transition and other administrative issues.

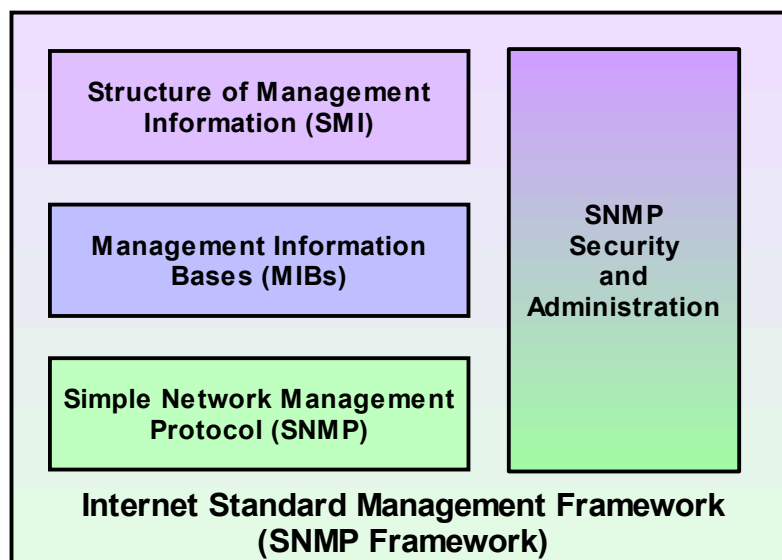

Figure 271: Components of the TCP/IP Internet Standard Management Framework

SNMP Framework Architecture

The creators of SNMP specifically designed the Framework to be modular because when SNMP was originally created, it was seen as only a temporary solution until a transition could be made to another network management protocol from the OSI protocol suite. The modular architecture separated definitional, data and functional (protocol) elements, to allow the SNMP protocol itself to be replaced without changing how network management information was defined and described.

This transition to the OSI protocol never occurred, but the architecture has still proven valuable in defining the entire scope of SNMP and in making its implementation much simpler. Each of the major components above, the SMI, MIBs and SNMP itself, are described in different standards. The modularity of the SNMP Framework has also allowed

changes to be made to these components relatively independently of each other, making the transition between SNMP versions easier than it would have been if one huge document defined everything.



Key Concept: The three main components of the Internet Standard Management Framework (SNMP Framework) are the Structure of Management Information (SMI), Management Information Bases (MIBs) and the SNMP Protocol itself. These are supported by SNMP security and administration elements.

TCP/IP Internet Standard Management Framework and SNMP Versions (SNMPv1, SNMPv2 Variants, SNMPv3)

In the [Networking Fundamentals chapter](#) near the beginning of this Guide, I have a [section that discusses networking standards and their importance](#). I also explain the differences between [proprietary, de facto and open standards](#), and explain the many benefits of open standards. History is replete with examples of technologies that have succeeded because they used an open standard where a competing standard was proprietary.

TCP/IP and the Internet are often held up as a model for proper open standards development. Thousands of TCP/IP standards have been developed and published using the well-known “Request For Comments” (“RFC”) standardization process. The result has been the most successful set of internetworking protocols in computing history, accepted and used worldwide.

Nobody is perfect, however, and no process is perfect either. Some problems occurred in the introduction of SNMP version 2, leading to a virtual breakdown in the normally smooth protocol standardization method, and a proliferation of incompatible “variants” that we aren’t used to seeing in TCP/IP. The story behind this is a continuation of [the general SNMP overview and history](#) from earlier in this section, and explains the many SNMP standard names and numbers, so you can make sense of them. At the same time, the discussion serves as a vivid reminder of how important proper standard development is, and what the consequences are when there isn’t universal agreement on how a standard should evolve.

SNMPv1

The first version of SNMP was developed in early 1988, and published in the form of three RFC standards in August 1988. This first version is now known as *SNMP version 1* or *SNMPv1*. The three SNMPv1 standards provided the initial description of the three main [Internet Standard Management Framework components](#): the Structure of Management Information (SMI), Management Information Bases (MIB) and the SNMP protocol itself. However, the term “Internet Standard Management Framework” was not actually used at that time.

SNMPv1 was generally accepted and widely deployed in many networks. SNMPv1 got the job done and became the standard for TCP/IP network management; it is still widely used today. It is the “Old Faithful” of SNMP versions. Slight revisions were made to the initial standards and more and more MIB modules were defined over time, but the technology remained the same for a number of years.

As with any technology, users of SNMPv1 identified weaknesses in it and opportunities for improvement, over time. One of the areas in which SNMPv1 was most criticized was the area of **security**. SNMP version 1 used only a “trivial” (as RFC 3410 puts it) authentication scheme using a password-like construct called a *community string*.

The issue of security turned out to be the bone of contention that eventually led to serious problems in the development of SNMP. Some people felt that community strings were sufficient security, but many others felt it was important that better security be put into SNMP. There were many different ways proposed to add security to SNMP, and no universal agreement on how to do it. The points raised about the security weaknesses in the original SNMPv1 had some validity, [as I explore in the SNMP protocol operations section](#).

SNMPsec

The first attempt to add security to SNMP came in the form of three standards published in July 1992 that defined a new security mechanism using logical identifiers called *parties*. This is sometimes called *SNMP Security* or *SNMPsec*. This method was more secure than the original SNMPv1, but SNMPsec was never widely accepted, and is now considered “historic”.

SNMPv2

While SNMPsec went away, the idea of party-based security it introduced never did. It was used as the basis of the definition of the first full revision of SNMP, when *SNMP Version 2* (*SNMPv2*) was published in RFCs 1441 through 1452 in April 1993. This new version incorporated the new security model, as well as making changes to the actual [SNMP protocol operations](#), changes to the [Structure of Management Information \(SMI\)](#) standard (defining version 2 of SMI, SMIv2), and formalizing the concept of the Internet Standard Management Framework.

Unfortunately, this new standard too was never universally accepted. Some people thought the whole new version was a great advance, but others took issue with the party-based security, claiming it was too complex. I am not familiar with all the details, but from what I understand, a great deal of debate and discussion took place over the next couple of years, as an attempt was made to get everyone “on board” with the new version.

SNMPv2 Variants

Acceptance of SNMPv2 never happened. Instead, different “splinter groups” broke off and began work on *variants* of SNMPv2. To prevent confusion, the original SNMPv2 became known as either *SNMPv2 classic* (reminiscent of the name a particular soft drink) or *SNMPv2p*, with the “p” referring to “party-based” security. Things got very interesting (and confusing) when the following were proposed and/or developed:

- ☉ **SNMPv1.5:** I can tell immediately that an idea is probably going to be a problem when it proposes a version number lower than a number already standardized. SNMPv1.5 was an attempt to retain the “uncontroversial” elements in SNMPv2p—the enhancements to the SNMP protocol and SMI—while going back to community-based security as in SNMPv1. It never became a standard itself, but became the basis of...
- ☉ **Community-Based SNMPv2 (SNMPv2c):** This is SNMPv2p modified to use community strings instead of party-based security; in essence, the same idea as SNMPv1.5 but with a more “official-sounding” name and a few changes. Interestingly, the standard that defines this, RFC 1901, still has an “experimental” status, despite the fact that SNMPv2c actually achieved some degree of commercial success where the “standard” SNMPv2p did not.

SNMPv2c was defined by standards RFC 1902 through 1908, which incorporate other changes including a new version of SMI (SMIv2).

- ☉ **User-Based SNMPv2 (SNMPv2u):** This is an alternative security method for SNMPv2c, which is based on users rather than community strings. It is considered simpler than party-based but more secure than community-string security. It is defined by RFC 1909 and RFC 1910. It too is formally considered “experimental”.
- ☉ **SNMPv2*:** As if all of the above was not enough, a well-known vendor decided to define another variant called *SNMPv2** that combined elements of SNMPv2p and SNMPv2u. This was never formally standardized. (Yes, that's an asterisk in the name. No, there's no footnote at the bottom of this topic, so don't bother looking for one. Yes, putting an asterisk in a name is extremely confusing. No, I don't know how it is that marketing people get paid good money to come up with names like that. ☺)

Now, imagine that you were a network administrator in the mid-1990s and were faced with SNMPv2p, SNMPv2c, SNMPv2u and SNMPv2*. Which one would you choose? Well, if you are like most people, you'd choose “none of the above”, saying “I think I'll stick with SNMPv1 until these version 2 folks get their act together”. And that's basically what happened. Some proponents of these variations promoted them, but there was never any agreement and the result was that the success of all of the various and sundry SNMPv2's was limited. As I said, a classic illustration of how important universal standardization is.

SNMPv3

I would imagine that at some point, everyone realized that the situation was a mess, and decided “enough is enough”. In 1996 work began on a new approach to resolve the outstanding issues and return universality to SNMP. In 1998, *SNMP version 3 (SNMPv3)* was developed, which includes additional enhancements to SNMP and finally gets all the players back on the same team.

SNMPv3 is the most current version of SNMP and is still being actively revised. One of the important changes in SNMPv3 is a more formalized way of handling different security approaches to SNMP—obviously, a lesson learned from the SNMPv2 experience.

SNMPv3 uses SNMPv2 protocol operations and its PDU message format, and the SMIV2 standard from SNMPv2 as well. SNMPv3 allows a number of different security methods to be incorporated into its architecture, and includes standards describing user-based security as defined in SNMPv2u and SNMPv2* as well as a new view-based access control model. It also includes additional tools to aid in the administration of SNMP.

TCP/IP Internet Standard Management Framework and SNMP Standards

We've now seen that there are [three different versions of the Internet Standard Management Framework](#). Some of these versions have different variants. Each version or variant of the Framework includes multiple modular components. Each component has one or more documents that define it. Some of *these* have multiple revisions. Add to that dozens of individual [Management Information Bases \(MIBs\)](#) defined for SNMP and other support documents and what do you have? A boatload of TCP/IP standards, that's what. There are probably more RFCs defining parts of SNMP than any other single TCP/IP protocol or technology.

It is specifically because there are so many versions and components and documents associated with SNMP that I feel it is important to keep all the standards straight. To that end I have created a number of tables, which show the major SNMP standards for each of the versions and variants of the SNMP Framework. Each individual RFC defines one component of one version of the Framework.

The usual way that RFCs work is that when new versions of a standard are released that are direct replacements for older ones, the older ones are “obsoleted” by the new ones. With SNMP, due to the many versions and the controversy over the variants, this is a bit unclear. For example, the standards defining SNMPv2p are not considered by the IETF to obsolete the standards for SNMPv1, but the IETF says the standards for SNMPv2c and SNMPv2u **do** obsolete those of SNMPv2p.

To keep all of this distinct I have made the decision to show the standards for each version or variant separately. I only put the RFC numbers for obsolete RFCs where those RFCs are for the same SNMP version or variant. For example, RFC 3410 obsoletes 2570 because they both deal with SNMPv3 and 3410 is a direct replacement for 2570. Also, there are a few cases where the name of a standard changed slightly between RFC numbers; I have shown the current name.

Each of the six tables below shows the current and obsoleted standards for one of the SNMP versions or variants: SNMPv1 ([Table 200](#)); SNMPSec ([Table 201](#)); SNMPv2p ([Table 202](#)); SNMPv2c ([Table 203](#)); SNMPv2u ([Table 204](#)) and SNMPv3 ([Table 205](#)). (SNMPv2* was not standardized using the regular RFC process.)

Table 200: SNMP Version 1 (SNMPv1) Standards

Obsolete RFCs	Most Recent RFC	Date of Most Recent RFC	Standard Name
1065	1155	May 1990	<u>Structure and identification of management information for TCP/IP-based internets</u>
1066	1156	May 1990	<u>Management Information Base for network management of TCP/IP-based internets</u>
1067, 1098	1157	May 1990	<u>Simple Network Management Protocol (SNMP)</u>
1158	1213	March 1991	<u>Management Information Base for Network Management of TCP/IP-based internets: MIB-II</u>

Table 201: SNMP Security (SNMPSec) Standards

Obsolete RFCs	Most Recent RFC	Date of Most Recent RFC	Standard Name
—	1351	July 1992	<u>SNMP Administrative Model</u>
—	1352	July 1992	<u>SNMP Security Protocols</u>
—	1353	July 1992	<u>Definitions of Managed Objects for Administration of SNMP Parties</u>

Table 202: Party-Based SNMP Version 2 (SNMPv2p) Standards (Page 1 of 2)

Obsolete RFCs	Most Recent RFC	Date of Most Recent RFC	Standard Name
—	1441	April 1993	<u>Introduction to version 2 of the Internet-standard Network Management Framework</u>
—	1442	April 1993	<u>Structure of Management Information for version 2 of the Simple Network Management Protocol (SNMPv2)</u>
—	1443	April 1993	<u>Textual Conventions for version 2 of the Simple Network Management Protocol (SNMPv2)</u>
—	1444	April 1993	<u>Conformance Statements for version 2 of the Simple Network Management Protocol (SNMPv2)</u>
—	1445	April 1993	<u>Administrative Model for version 2 of the Simple Network Management Protocol (SNMPv2)</u>
—	1446	April 1993	<u>Security Protocols for version 2 of the Simple Network Management Protocol (SNMPv2)</u>

Table 202: Party-Based SNMP Version 2 (SNMPv2p) Standards (Page 2 of 2)

Obsolete RFCs	Most Recent RFC	Date of Most Recent RFC	Standard Name
—	1447	April 1993	<i>Party MIB for version 2 of the Simple Network Management Protocol (SNMPv2)</i>
—	1448	April 1993	<i>Protocol Operations for version 2 of the Simple Network Management Protocol (SNMPv2)</i>
—	1449	April 1993	<i>Transport Mappings for version 2 of the Simple Network Management Protocol (SNMPv2)</i>
—	1450	April 1993	<i>Management Information Base for version 2 of the Simple Network Management Protocol (SNMPv2)</i>
—	1451	April 1993	<i>Manager-to-Manager Management Information Base</i>
—	1452	April 1993	<i>Coexistence between version 1 and version 2 of the Internet-standard Network Management Framework</i>

Table 203: Community-Based SNMP Version 2 (SNMPv2c) Standards

Obsolete RFCs	Most Recent RFC	Date of Most Recent RFC	Standard Name
—	1901	January 1996	<i>Introduction to Community-based SNMPv2</i>
—	1902	January 1996	<i>Structure of Management Information for Version 2 of the Simple Network Management Protocol (SNMPv2)</i>
—	1903	January 1996	<i>Textual Conventions for Version 2 of the Simple Network Management Protocol (SNMPv2)</i>
—	1904	January 1996	<i>Conformance Statements for Version 2 of the Simple Network Management Protocol (SNMPv2)</i>
—	1905	January 1996	<i>Protocol Operations for Version 2 of the Simple Network Management Protocol (SNMPv2)</i>
—	1906	January 1996	<i>Transport Mappings for Version 2 of the Simple Network Management Protocol (SNMPv2)</i>
—	1907	January 1996	<i>Management Information Base for Version 2 of the Simple Network Management Protocol (SNMPv2)</i>
—	1908	January 1996	<i>Coexistence between Version 1 and Version 2 of the Internet-standard Network Management Framework</i>

Table 204: User-Based SNMP Version 2 (SNMPv2u) Standards

Obsolete RFCs	Most Recent RFC	Date of Most Recent RFC	Standard Name
—	1909	February 1996	<i><u>An Administrative Infrastructure for SNMPv2</u></i>
—	1910	February 1996	<i><u>User-based Security Model for SNMPv2</u></i>

Table 205: SNMP Version 3 (SNMPv3) Standards

Obsolete RFCs	Most Recent RFC	Date of Most Recent RFC	Standard Name
—	2576	March 2000	<i><u>Coexistence between Version 1, Version 2, and Version 3 of the Internet-standard Network Management Framework</u></i>
—	2578	April 1999	<i><u>Structure of Management Information Version 2 (SMIv2)</u></i>
—	2579	April 1999	<i><u>Textual Conventions for SMIv2</u></i>
—	2580	April 1999	<i><u>Conformance Statements for SMIv2</u></i>
2570	3410	December 2002	<i><u>Introduction and Applicability Statements for Internet-Standard Management Framework</u></i>
2261, 2271, 2571	3411	December 2002	<i><u>An Architecture for Describing Simple Network Management Protocol (SNMP) Management Frameworks</u></i>
2262, 2272, 2572	3412	December 2002	<i><u>Message Processing and Dispatching for the Simple Network Management Protocol (SNMP)</u></i>
2263, 2273, 2573	3413	December 2002	<i><u>Simple Network Management Protocol (SNMP) Applications</u></i>
2264, 2274, 2574	3414	December 2002	<i><u>User-based Security Model (USM) for version 3 of the Simple Network Management Protocol (SNMPv3)</u></i>
2265, 2275, 2575	3415	December 2002	<i><u>View-based Access Control Model (VACM) for the Simple Network Management Protocol (SNMP)</u></i>
—	3416	December 2002	<i><u>Version 2 of the Protocol Operations for the Simple Network Management Protocol (SNMP)</u></i>
—	3417	December 2002	<i><u>Transport Mappings for the Simple Network Management Protocol (SNMP)</u></i>
—	3418	December 2002	<i><u>Management Information Base (MIB) for the Simple Network Management Protocol (SNMP)</u></i>

In addition to all of these tables, as I mentioned before, there are dozens of supplemental RFCs that describe MIB modules and also clarify various fine points of operation related to SNMP. Listing all of these would... make me go insane. Sorry, those tables were bad enough. ☺ You can find all the MIBs in an online list of RFCs by searching for “MIB” or “SNMP”.



On The Web: A full, hyperlinked list of RFCs can be found at: <http://www.rfc-editor.org/rfc-index.html>



TCP/IP Structure of Management Information (SMI) and Management Information Bases (MIBs)

The Internet Standard Management Framework defines three major components that describe how devices can be managed on a TCP/IP internetwork. One of these, the actual [Simple Network Management Protocol \(SNMP\)](#) is relatively well-known, but is only part of the overall picture. SNMP describes how information is exchanged between SNMP entities, but two other components are equally important because they describe the information itself.

In this section I describe these two important supporting elements of the TCP/IP Internet Standard Management Framework: the Management Information Base (MIB) standard that describes types of information that SNMP works with, and the Structure of Management Information (SMI) standard that specifies how MIB information is defined. Understanding these two parts of the SNMP Framework is an important initial step before we examine the actual SNMP protocol itself.

Since SMI and MIBs are so closely related, they are described in combination here. I begin with an overview description of the SMI data description language and how management information bases (MIBs) work. I discuss the MIB object name hierarchy and the notation used to refer to names. I also describe how MIB objects work, discussing the different object types and MIB object groups.



Background Information: If you have not yet already read [the section describing the SNMP Internet Standard Management Framework](#), you should do so before proceeding here.



Note: I describe here MIB concepts common to all of the versions of SNMP, and discuss both of the specific versions of SMI (SMIv1 and SMIv2) used in those SNMP versions.

TCP/IP Structure of Management Information (SMI) and Management Information Bases (MIBs) Overview

The key to really understanding TCP/IP network management is to comprehend the *information-oriented* nature of the entire [Internet Standard Management Framework \(SNMP Framework\)](#). To see what I mean by this, let's step back for a moment and consider in general terms the problem of network management, and more specifically, the problem of managing devices on a network.

Understanding SNMP's Information-Oriented Design

A network administrator needs to perform two basic types of actions: gather data about devices to learn how they are functioning, and give commands to devices to change how they are functioning. In the simplest terms, the first category can be considered like a “read” operation, and the second is comparable to a “write” operation.

A classical way of implementing this functionality is to define a communication protocol. Most such protocols are *command-oriented*—they consist of a specific set of commands to perform the “read” and “write” operations we mentioned above. For example, a network management protocol might have a read command such as “report on number of hours device has been in use”, and a write command such as “put this device into test mode”. The network manager would control the device by giving the appropriate commands.

A command-oriented management protocol has the advantage of simplicity: it's clear what the commands are for and how they are to be used. It can be reasonably well-suited for use in certain environments, but it doesn't work well on a large, heterogeneous TCP/IP inter-network. The main reason for this is that command-orientation inextricably ties the protocol to the devices being managed. Consider:

- ☉ Every type of device might require a distinct set of commands. For example, the commands given to a router might need to be different than those given to a host. This would lead either to a proliferation of commands in the protocol, or to inflexibility in allowing proper management of different device types.
- ☉ Every time a company created a new type of device, or made a unique version of a type of device, the network management protocol would have to be changed.
- ☉ Whenever the operation of a kind of device changed, due perhaps to a change in another protocol, the management protocol would need to be updated.
- ☉ The protocol itself could not be easily changed without affecting a lot of hardware.

The solution to the problems of command-oriented management protocols was to use an *information-oriented* model. Instead of defining specific commands that interrogate or control devices, the devices are defined in terms of units of information that are to be exchanged between the devices and a management station.

Instead of “read” commands and “write” commands, we have *variables* that can be “read” or “written”. Take the two examples mentioned earlier. Instead of a command like “report on a number of hours device has been in use”, the device keeps a variable called “number of hours in use” and the network management station can “read” this as one of many variables, with no need for a specific protocol command. Instead of a “write” command called “put this device into test mode”, the device has a variable called “current mode”. The network manager can change the mode of the device to “test” by changing the value of the variable.

This difference may seem subtle, but it in fact underlies every aspect of how SNMP works. I believe part of why the SNMP Framework is hard to understand is because insufficient emphasis is placed on looking at things in the “SNMP way”, which means thinking about information objects and not commands.



Key Concept: Unlike most protocols, which are command-oriented, SNMP is *information-oriented*. SNMP operations are implemented using objects called *variables* that are maintained in managed devices. Rather than issuing commands, a network management station checks the status of a device by reading variables, and controls the operation of the device by changing (writing) variables.

The Management Information Base (MIB) and MIB Objects

Given this backdrop, we can look at the SNMP Framework in a new light. The actual SNMP protocol itself, which we'll examine in the next section, has only a few, generic commands to accomplish “read” and “write” tasks as mentioned just above. It deals with only the methods by which network management information is exchanged between [SNMP agents](#) and [SNMP network management stations](#). The network management information is really the heart of TCP/IP network management.

So, instead of SNMP being defined in terms of commands used to control particular devices, it is defined in terms of management information variables, generally called *objects*. Each object describes a particular characteristic of a device. Some objects are fairly generic and are meaningful for any device on a TCP/IP network; for example, an object describing something related to the Internet Protocol itself, such as the device's IP address. Other objects might be particular to a specific type of device; for example, a router will have objects that a regular host's Ethernet network interface card would not.

A collection of objects used in SNMP is called a *management information base*, or *MIB*. (In fact, SNMP objects are often called *MIB objects*.) The first version of SNMP, SNMPv1, had a single standard that defined the entire MIB for SNMP. Newer versions however provide more flexibility by using different *MIB modules* that defines sets of variables particular to the hardware or software used by a device.

Defining objects using modules allows for significant flexibility in defining the variables that allow management of different types of devices. A device can incorporate all the MIB modules appropriate to the hardware and software it uses. For example, if you had a device using Ethernet, it would incorporate variables from the Ethernet MIB; one using Token Ring would use the Token Ring MIB. Both devices would also use the common SNMP MIB that is used by all TCP/IP devices. Other modules might also be included as needed. We'll see more of how this works later in this section.



Key Concept: The management data variables in a managed device are maintained in a logical collection called a *management information base (MIB)*. The objects in the MIB are often called *MIB objects*, and are typically collected into sets called *MIB modules*.

Defining MIB Objects: the Structure of Management Information (SMI)

The use of MIB objects solves the problem of the network management protocol being tied to the network management information. However, we must be very particular about how we define these objects. Again, the reason is the wide variety of devices that TCP/IP allows to be connected together. Each device may represent information in a different way; for them all to communicate with each other, we need to ensure that management information is represented in a consistent manner.

The part of the SNMP Framework that ensures the universality of MIB objects is the *Structure of Management Information (SMI)* standard. SMI defines the rules for how MIB objects and MIB modules are constructed. In SMI, MIB objects are described using a precise set of definitions based on a data description language called the ISO *Abstract Syntax Notation 1 (ASN.1)* standard.

In essence then, we really have three “levels of abstraction” in SNMP. The actual SNMP protocol moves values that represent the state of management devices. The MIB defines what these variables are. And the SMI defines how the variables in the MIB are themselves defined.

There are two main SMI standards. The original, *SMIv1*, was part of the first SNMP Framework, SNMPv1, defined in RFC 1155. It sets out the basic rules for management information bases and MIB variables. The second, *SMIv2*, was defined as part of SNMPv2p in RFC 1442 and further updated in RFC 2578, part of SNMPv3. It is similar to the earlier version but defines more object types as well as the structure of MIB modules.

These SMI standards are responsible for defining the following important information elements in SNMP:

- ☉ The general characteristics associated with all MIB objects. SMI defines the standard way by which all MIB objects are described.
- ☉ The different types of MIB objects that can be created, such as integers, strings and more complex data types.
- ☉ A hierarchical structure for naming MIB objects, so they can be addressed in a consistent manner without names overlapping.
- ☉ The information associated with each MIB module.



Key Concept: The *Structure of Management Information (SMI)* standard is responsible for defining the rules for how MIB objects are structured, described and organized. SMI allows dissimilar devices to communicate by ensuring that they use a universal data representation for all management information.

In fact, the SMI and MIB standards are so closely related that it is hard to discuss one without the other. The rest of this section discusses SNMP management information structures making reference to both SNMP Framework components. We'll see how [MIB objects are defined and the characteristics of each](#), and look at MIB data types, [the structure used to organize MIB objects](#), and the way [MIB modules and object groups](#) work.



Note: Due to its name, the management information base is often called a “database”. This is, strictly speaking, inaccurate. The MIB is a description of objects. The actual MIB in a device *may* be implemented as a software database, but it need not be.

TCP/IP MIB Objects, Object Characteristics and Object Types

The Internet Standard Management Framework (SNMP Framework) is designed to facilitate the exchange of management information. The *Management Information Base (MIB)* defines a device's management information. The MIB contains a number of variables called *MIB objects*; they are also called *managed objects*. These objects are defined according to the rules set out in the [Structure of Management Information \(SMI\)](#) standard.

The best place to begin looking at MIB objects is by examining the SMI rules that define them. As I mentioned earlier in this section, two different versions of SMI have been created: SMIv1 as part of the original SNMP, and SMIv2 as part of SNMPv2 and SNMPv3. The two are similar in terms of how MIB objects are described, but SMIv2 allows more information to be associated with each object.

MIB Object Mandatory Characteristics

Just as a typical protocol uses a field format for specifying the content of messages sent between devices using the protocol, SMI uses a format that specifies the fundamental characteristics of each MIB object. The most basic of these are five mandatory characteristics defined in SMIv1. These are also used in SMIv2, but a couple of names were changed, and the possible values for some of the fields were modified as well. This is shown conceptually in [Figure 272](#).

Object Name

Each object has a name that serves to uniquely identify it. Actually, that's not entirely true. Each object actually has *two* names: a textual name called an *Object Descriptor* and a numeric *Object Identifier* that indicates the object's place in the MIB object name hierarchy. I'm sure that made no sense to you, but that's why I included [the next topic discussing object naming](#) that hopefully will (make sense that is.)

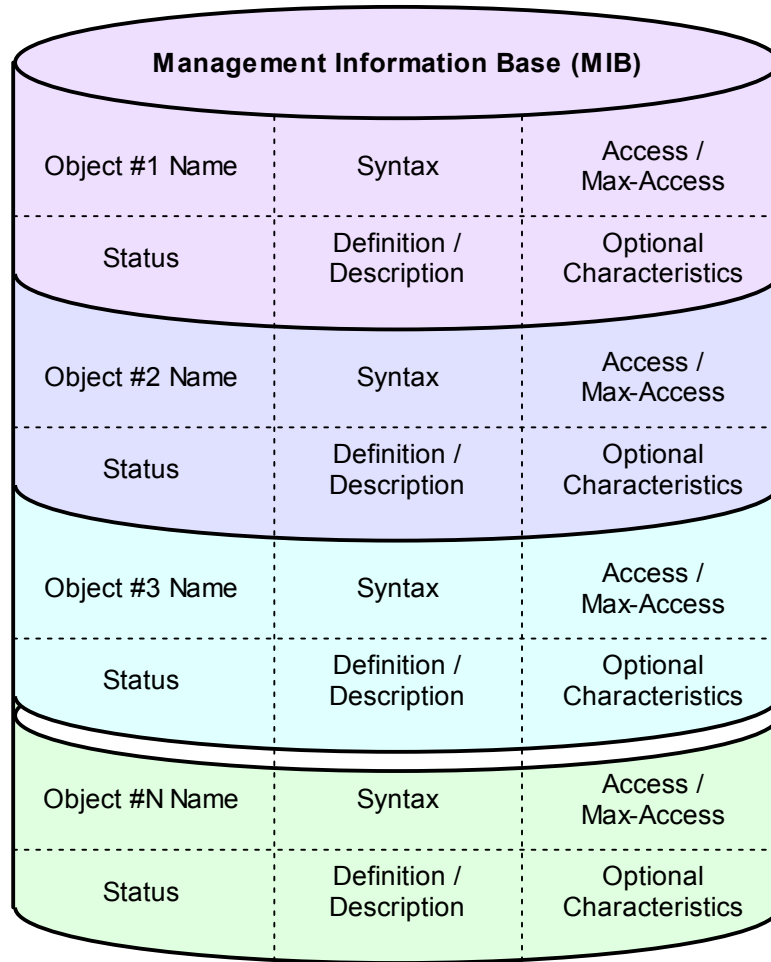

Figure 272: SNMP Management Information Base (MIB)

This diagram shows an SNMP management information base containing "N" MIB objects. Each object has five mandatory characteristics and a variable number of optional characteristics.

Syntax

An object's *Syntax* defines its data type and the structure that describes it. This attribute of an MIB object is very important because it defines the data type of information that the object contains. There are two basic categories of data types allowed:

- ☉ **Regular Data Types:** These are single pieces of information, of the type we are used to dealing with on a regular basis; examples would be integers or strings. These are called *base types* in SMIv2. SMIv1 differentiates between *primitive types* like integers defined in ASN.1, and *defined types* that are special forms of primitive types that are still single pieces of information but with certain special meaning attached to how they are used. SMIv2 doesn't use those two terms.

- ☉ **Tabular Data:** A collection of multiple data elements. This may take the form of a list of base types or a table of base types. For example, a table of integers could be constructed to represent a set of values. In SMIv1 these are called *constructor types*; in SMIv2 they are *conceptual tables*. They can be accessed using special SNMP mechanisms designed for reading tables. See the topic on SNMP table traversal for more on tables.

Access (*Max-Access* in SMIv2)

This field defines the ways that an SNMP application will normally use the object. In SMIv1, there are four different possible values: *read-only*, *read-write*, *write-only*, and *not-accessible*.

In SMIv2 there are five values, which are described as a hierarchy of sorts. SMIv2 calls this characteristic *Max-Access* (*maximum access*) to make it explicit that higher access levels include the lower levels as well. For example, an object with *read-create* access can also be used in any of the modes “below it”, such as *read-write*, but not vice versa. Table 206 shows the five SMIv2 access values, in decreasing order of access. Note that *write-only* has been removed in SMIv2:

Table 206: SNMP SMI Version 2 *Max-Access* Values

<i>Max-Access Value</i>	Description
<i>read-create</i>	Object can be read, written or created.
<i>read-write</i>	Object can be read or written.
<i>read-only</i>	Object can only be read.
<i>accessible-for-notify</i>	Object can be used only using SNMP notification (SNMP traps).
<i>not-accessible</i>	Used for special purposes.

Status

Indicates the currency of the object definition. In SMIv1 there are three values: *mandatory*, *optional* and *obsolete*. In SMIv2, the first two are combined into simply *current*, meaning a current definition. The value *obsolete* is retained, and *deprecated* is added, meaning the definition is obsolete but maintained for compatibility.

Definition (*Description* in SMIv2)

A textual description of the object.



Key Concept: Each management information variable, called a *MIB object*, has associated with it five key attributes: its name, syntax, maximum access, status and definition. It may also have a number of optional characteristics.

SMIv2 MIB Object Optional Characteristics

SMIv2 adds the following optional characteristics that may appear in the definition of an object:

- ☉ **Units:** A text description of the units associated with the object.
- ☉ **Reference:** A text cross-reference to a related document or other information of relevance to the object.
- ☉ **Index:** A value used to define objects that are actually more complex “rows” of other objects.
- ☉ **Augments:** An alternative to the *Index* field.
- ☉ **DefVal:** Defines an acceptable default value for the object.

SMI Regular Data Types

Table 207 shows the regular data types supported for objects in both SMIv1 and SMIv2. (The names with “32” in them are the ones used in SMIv2; they were changed to make the type’s bit size explicit.) The first five entries in the table are primitive types, the rest are defined types, using the SMIv1 terminology.

Table 207: SNMP SMI Regular Data Types (Page 1 of 2)

Data Type Code	Description	SMIv1?	SMIv2?
<i>Integer / Integer32</i>	A 32-bit signed integer in two's complement notation, capable of holding a value from -2,147,483,648 to +2,147,483,647. Can also be used to represent an enumerated type; for example, where 1 represents a particular constant, 2 represents a different one, and so on.	Yes	Yes
<i>Octet String</i>	A variable-length string of binary or text data.	Yes	Yes
<i>Null</i>	Nothing.	Yes	—
<i>Bits</i>	An enumeration of named bits. Used to allow a set of bit flags to be treated as a single data type.	—	Yes
<i>Unsigned</i>	A 32-bit unsigned integer, from 0 to 4,294,967,295.	—	Yes
<i>Network Address / IpAddress</i>	An IP address, encoded as a 4-byte octet string.	Yes	Yes
<i>Counter / Counter32</i>	A 32-bit unsigned integer, that begins at 0 and increases up to 4,294,967,295, then wraps back to 0.	Yes	Yes
<i>Gauge / Gauge32</i>	A 32-bit unsigned integer, that may have a value from 0 to 4,294,967,295 and may increase or decrease, like a gauge. A minimum and maximum value are associated with the gauge, indicating its normal range.	Yes	Yes
<i>TimeTicks</i>	A 32-bit unsigned integer that indicates the number of hundredths of seconds since some arbitrary start date. Used for timestamping and to compute elapsed time.	Yes	Yes

Table 207: SNMP SMI Regular Data Types (Page 2 of 2)

Data Type Code	Description	SMIv1?	SMIv2?
<i>Opaque</i>	Data using arbitrary ASN.1 syntax that is to be passed between devices without being interpreted. As in NFS's <i>XDR</i> , the term "opaque" means that the data is treated like a "black box" whose internal details cannot be seen.	Yes	Yes
<i>Counter64</i>	A counter like Counter32 but 64 bits wide, allowing a value from 0 to 18,446,744,073,709,551,615.	—	Yes

SMIv2 Textual Conventions

In addition to these types, other defined types are also created to again, indicate more specific semantics for a particular data type. These are called *textual conventions* and are described in RFC 2579 for SMIv2. For example, a type called *TimeStamp* is defined which is the same as *TimeTicks*. However, seeing an object using the former rather than the latter makes it more clear that the variable is representing a particular time stamp value. Another is called *TimeInterval*, which is also just an integer underneath its name, but conveys a different interpreted meaning.

Example SMIv2 Object Definition

If all of the above seemed very confusing to you, note that this topic is in fact a significant simplification of SMI's object definitions. SNMP is so much fun! If an example will help, check out [Table 208](#), which shows an object definition from RFC 3418, using SMIv2.

Table 208: Example SNMP SMIv2 Object Definition

<pre> sysLocation OBJECT-TYPE SYNTAX DisplayString (SIZE (0..255)) MAX-ACCESS read-write STATUS current DESCRIPTION "The physical location of this node (e.g., 'telephone closet, 3rd floor'). If the location is unknown, the value is the zero-length string." ::= { system 6 } </pre>
--

Note that *DisplayString* is a textual convention for a displayed text string. The last part, "{ system 6 }", will be explained in the next topic.

TCP/IP MIB Object Descriptors and Identifiers and the Object Name Hierarchy and Name Notation

Of the many [MIB object characteristics](#), only one is sufficiently interesting that it really deserves its own exposition. Or perhaps I should say, only one is sufficiently **complicated** that it does. ☺ This is the object name, part of the larger naming system used for MIB objects.

As I said before, each MIB object actually has two names: an *object descriptor* and an *object identifier*. The object descriptor is a conventional text name that provides a “user-friendly handle” to refer to the object. The name is assigned based on the particular MIB object group in which the object is located. In the example definition I gave at the end of the prior topic, *sysLocation* is the object descriptor for that MIB object. I describe these names in greater detail in the next topic, on [MIB modules and object groups](#).

The MIB Object Name Hierarchy

Text names are convenient, but they are generally ***unstructured***. There are at present over 10,000 different MIB objects, and even if each has a distinct text name, a huge collection of such names doesn't help us to manage these objects and see how they are related. For this, we need a more structured approach to categorizing and naming objects.

This problem is similar to another problem that you may recall reading about: [the problem of how to assign names on the Internet](#). Originally names for hosts were simple, “flat” names, but this quickly grew unwieldy. The [Domain Name System \(DNS\)](#) formalized a structured hierarchy for domain names. The [DNS hierarchical name space](#) allows every device to be arranged into a single hierarchical tree structure. The name of the device can be formed by traversing the tree from the top down to the location of the device, listing the labels traversed separated by dots. For example, the Web server of The PC Guide is at “www.pcguid.com”.

This exact same concept is used to organize MIB objects in SNMP. A single universal hierarchy is used that contains all MIB objects. It is hierarchical in nature, and split into levels from the most general to the most specific. Each object has a particular place in the hierarchy. The names are formed by following the labels from the top of the tree down to the place where the object is located, and separating them with “dots”. (SNMP doesn't reverse the order of the labels the way DNS does, however. They are listed top-down from left to right.)

There is another important difference between the MIB name hierarchy and the DNS one: the MIB name hierarchy is even more universal than the one for DNS. The entire subtree of all MIB objects is just one branch of the full, international object hierarchy maintained by ISO and ITU. This object identification hierarchy is so general that it can contain a name for every object or variable in use by any technology in the entire world. And possibly other planets. Or solar systems. ☺

The reason for my jocularly will become apparent in a moment. Suffice to say, this object tree is enormous. Each node in this tree is identified with both a label and an integer. The labels are for descriptive purposes; object (or subtree) identifiers are formed by listing the numbers in sequence from the top of the tree down to the node, separated by dots. (The text labels can be used for names too but are not because they would get very long due to how deep the tree structure is.)



Key Concept: SNMP MIB objects have two names. The first is a text *object descriptor*, which provides a means of addressing the object in a way that is familiar and easy for humans. The second is the *object identifier*, which consists of a sequence of integers that specifies the location of the object in the global object hierarchy maintained by the international standards bodies ISO and ITU.

Structure of the MIB Object Name Hierarchy

Let's explore how the MIB object tree is structured, and more importantly, how SNMP MIB objects fit into it (you may find referring to [Figure 273](#) useful as you proceed here.) The tree's root has no label, and has three children:

- **ccitt(0):** For ITU (formerly the CCITT) standards. (Also seen as *itu(0)*).
- **iso(1):** For ISO standards.
- **joint-iso-ccitt(2):** For joint standards. (Also seen as *joint-iso-itu(2)*).

Following the *iso(1)* node, we see the following at the next several levels:

- Within *iso(1)*, the ISO has created a subtree for use by other organizations, called *org(3)*.
- Within *org(3)*, there is a subtree for the United States Department of Defense, which as you may recall was the originator of the Internet: *dod(6)*.
- Within *dod(6)*, there is a subtree called *internet(1)*.

Everything we work with in SNMP is under this one very specific subtree: 1.3.6.1, which if we used the text labels would be "iso.org.dod.internet". Within this part of the name space, there are six subtrees below:

- **directory(1):** Reserved for future use by ISO.
- **mgmt(2):** The primary subtree where MIB objects are located. This is "1.3.6.1.2". It contains a subtree called *mib(1)*, which is 1.3.6.1.2.1. When MIB-II was created, a subtree called *mib-2(1)* was created using the same number, 1.3.6.1.2.1.
- **experimental(3):** Contains objects used for standards under development. This is "1.3.6.1.3".
- **private(4):** Used for objects defined by private companies. This node, 1.3.6.1.4, has a subtree called *enterprise(1)*, which is 1.3.6.1.4.1.
- **security(5):** Reserved for security use.
- **snmpV2(6):** Defines objects used specifically for SNMP version 2.

Phew. So, what's the bottom line of all this? Well, basically all MIB module objects are named within one of these two branches of the overall object tree:

- **Regular MIB Objects:** These are in the *mib(1)* subtree under *mgmt(2)*: 1.3.6.1.2.1.

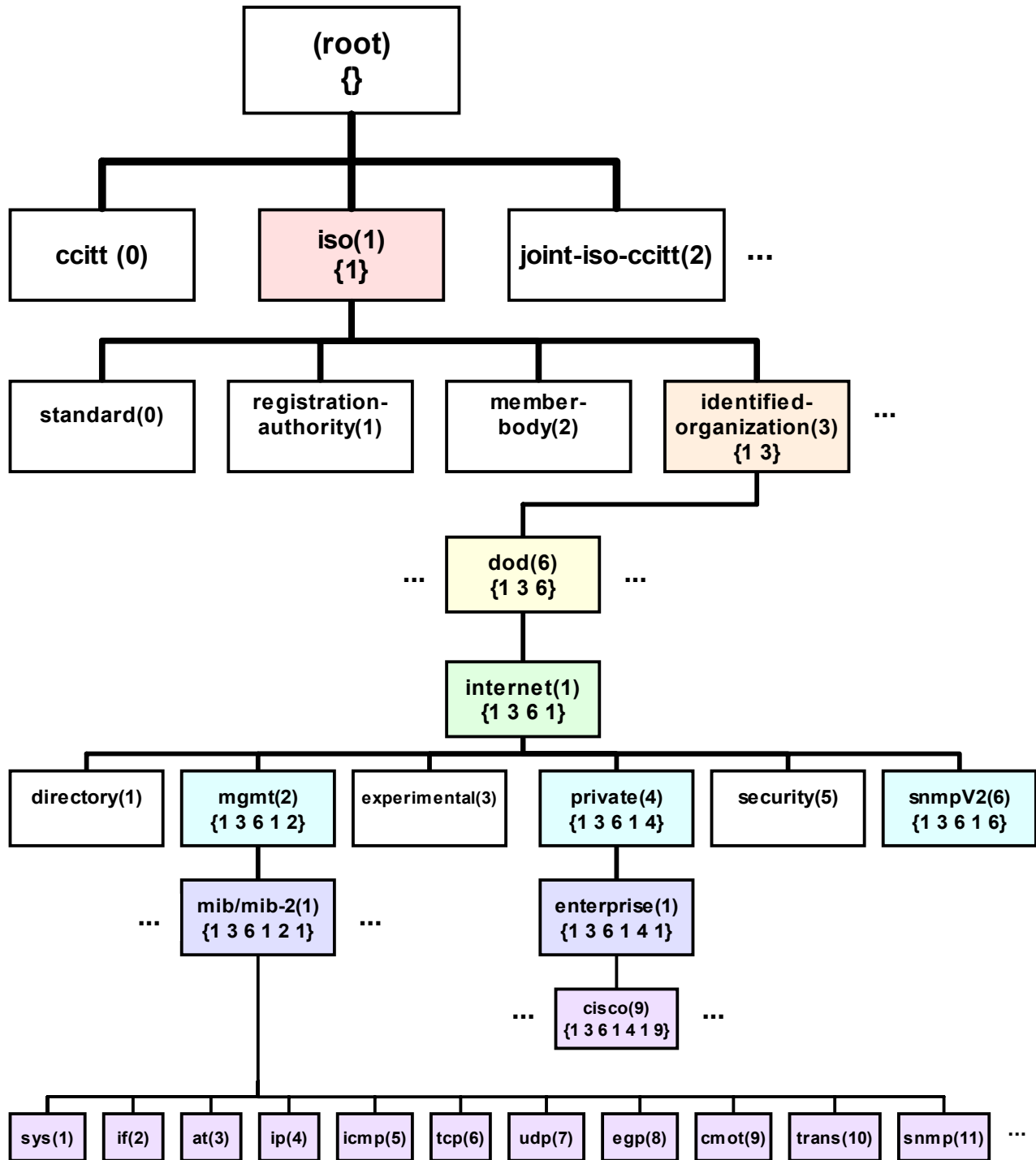

Figure 273: Global Object Name Hierarchy and SNMP MIB Hierarchies

This diagram shows the object name hierarchy defined by ISO and CCITT (ITU) to allow all types of objects to be universally represented. The “path” within this larger tree to the tree branches relevant to SNMP can be found by following the colored boxes. The two subtrees used for SNMP are shown in light blue. Each contains its own substructure (some of which is illustrated by boxes in purple) defining thousands of different MIB objects. The branch on the left side is used for generic MIB objects and the one on the right for private ones. A separate hierarchy is also define for SNMP V2.

-
- ☉ **Private MIB Objects:** These are in the *enterprise(1)* subtree under *private(4)*, which is 1.3.6.1.4.1. For example, within *enterprise(1)* there is an entry *cisco(9)* for Cisco Systems. So all Cisco-specific MIB objects start with 1.3.6.1.4.1.9.

Clear as mud, right? Why didn't they just make a separate hierarchy where “mib” was at the top instead of 6 levels deep? How dare you even suggest such a thing. Don't you understand the importance of global standards? ☺

All facetiousness aside, this name hierarchy is a bit cumbersome to deal with (okay, more than a bit) but it does allow us to keep MIB objects organized in a sensible way. Within the 1.3.6.1.2.1 subtree we find most of the regular MIB objects used in SNMP. Each subtree within 1.3.6.1.2.1 corresponds to one of the [regular SNMP object groups](#) or a [particular MIB module](#).



Key Concept: All MIB objects have object identifiers that fit within two branches of the global object hierarchy. Regular MIB objects (which are not vendor-specific) fit in the *mib(1)* subtree under *mgmt(2)*: 1.3.6.1.2.1. Private objects, which can be created by a hardware vendor to assist in managing that vendor's products, are in the *enterprise(1)* subtree under *private(4)*, which is 1.3.6.1.4.1

Recursive Definition of MIB Object Identifiers

An object is given a text object descriptor by putting its name at the start of the object as shown in [Table 208](#), but the definition of numeric object identifiers is, again, more complex. It is done by defining only the number of the object within its particular subtree. This means the object identifiers are defined **recursively** (one based on another) and are not explicitly stated for each object. Syntactically precise, but makes it hard to see at a glance what the number is for any particular object.

Consider again the example in [Table 208](#). For this object, *sysLocation* is the object descriptor, and “{ system 6 }” is the object identifier. This means it is object number 6 within the node *system*, which is in turn defined as “{ mib-2 1 }”—it is the first node within the *mib-2* subtree. Since *mib-2* is, as we said above, 1.3.6.1.2.1, this means *system* is 1.3.6.1.2.1.1 and *sysLocation* is 1.3.6.1.2.1.1.6.

TCP/IP MIB Modules and Object Groups

The [Management Information Base \(MIB\)](#) contains the collection of MIB objects that describe the characteristics of a device using the [Internet Standard Management Framework \(SNMP Framework\)](#). When SNMP was first created, there were not that many objects in the MIB. Furthermore, they were mostly “generic” objects that applied fairly universally to TCP/IP devices as a whole. In fact, most of the MIB objects were variables related to the operation of TCP/IP protocols such as IP, TCP and ICMP.

For this reason, at first, a single document defined “the” Management Information Base (MIB) for SNMP. The first of these documents was RFC 1066, part of the initial SNMPv1 specification. It was then revised in RFC 1156. In RFC 1158, a second version of the MIB, *MIB II*, was defined, which was essentially the same but made a few changes.

The Organization of MIB Objects into Object Groups

The number of MIB objects defined in these standards was relatively small. However, there were still several dozen of them, and it was recognized from the start that more would be created in time. To help organize the objects in a logical way, they were arranged into *object groups*. These groups serve the purpose of separating the objects and defining how they should be given object identifiers in the overall [object name hierarchy](#).

Each group has associated with it three important pieces of information:

- ☉ **Group Name:** A name that is used as a text label in the object identification tree we saw in the previous topic. These objects are all located within the “iso.org.dod.internet.mgmt.mib” subtree. So for example, the group *system* would be “iso.org.dod.internet.mgmt.mib.system”.
- ☉ **Group Number:** A number corresponding to the group name used for making numeric identifiers from the object name tree. For example, the group *system* has the number 1, and so the group's object identifier is 1.3.6.1.2.1.1. All objects in that group will be under that tree; for example, *sysUpTime* is 1.3.6.1.2.1.1.3.
- ☉ **Group Code:** A text label that may be the same as the group name or may be an abbreviation. It is used as a prefix in making object descriptors (the text names of objects). For example, for the group *system* the code is *sys*, and so an object in this group is *sysUpTime*.

Generic MIB Object Groups

[Table 209](#) shows the eight generic SNMP groups defined in RFC 1158 along with their codes, names and numbers.

Table 209: SNMP Generic MIB Object Groups (Page 1 of 2)

Group Name	Group Code	Group Number	Full Group Identifier	Description
<i>system</i>	<i>sys</i>	1	1.3.6.1.2.1.1	General objects of relevance to all or most devices. For example, a general description of the device is an object in this group, as is the identifier of the object. Later MIB versions greatly expanded the number of variables in this group.
<i>Interfaces</i>	<i>if</i>	2	1.3.6.1.2.1.2	Objects related to the IP interfaces between this device and the internetwork; recall that a regular host normally has one interface while a router has two or more .
<i>at (address translation)</i>	<i>at</i>	3	1.3.6.1.2.1.3	Objects used for IP address translation. (No longer used.)

Table 209: SNMP Generic MIB Object Groups (Page 2 of 2)

Group Name	Group Code	Group Number	Full Group Identifier	Description
<i>ip</i>	<i>ip</i>	4	1.3.6.1.2.1.4	Objects related to the IP layer of the device as a whole (as opposed to interface-specific information in the <i>if</i> group.)
<i>icmp</i>	<i>icmp</i>	5	1.3.6.1.2.1.5	Objects related to the operation of the Internet Control Message Protocol .
<i>tcp</i>	<i>tcp</i>	6	1.3.6.1.2.1.6	Objects related to the operation of the Transmission Control Protocol .
<i>udp</i>	<i>udp</i>	7	1.3.6.1.2.1.7	Objects related to the operation of the User Datagram Protocol .
<i>egp</i>	<i>egp</i>	8	1.3.6.1.2.1.8	Objects related to the operation of the Exterior Gateway Protocol .
<i>cmot</i>	<i>cmot</i>	9	1.3.6.1.2.1.9	Objects related to running the CMIP protocol over TCP (historical, not used.)
<i>transmission</i>	<i>trans</i>	10	1.3.6.1.2.1.10	Objects related to the specific method of information transmission used by each interface on the system.
<i>snmp</i>	<i>snmp</i>	11	1.3.6.1.2.1.11	Objects used to manage SNMP itself.

All of the groups in this table are fairly generic, and with the exception of the one about EGP, apply to pretty much every TCP/IP system using SNMP. The first five groups and the last one are “mandatory” for all systems; the others are used only by devices that use the indicated protocols or functions. The mention of [EGP](#), a routing protocol now considered obsolete, shows the age of this list.

MIB Modules

What's most conspicuous about [Table 209](#) are the groups that are *not* in it. There are no groups for most of the other TCP/IP protocols, nor any for variables that might be needed for specific hardware types. For example, most hosts will have a network card in them using a layer two protocol like Ethernet or Token Ring; how does a manager check or control the operation of this hardware? What about newer routing protocols like [OSPF](#) or [BGP](#)? How about objects related to running the [Domain Name System](#)?

Updating the MIB document constantly would have been impractical. Instead, in SNMPv2, the Management Information Base was changed from a single document to a group of documents. The basic organization into groups of objects was retained, but instead of all groups being in the same standard, they are divided into multiple standards. A method was also defined for how to create *MIB modules* that describe new groups of objects specific to a particular technology. A list of these modules is maintained by [IANA](#), the organization that maintains all of these sorts of numbers.



On The Web: The current list of SNMP MIB modules can be found here: <http://www.iana.org/assignments/smi-numbers>

The use of MIB modules makes putting SNMP support into a device somewhat like “going shopping”. The basic groups common to all devices are incorporated into each device, and then other modules/groups are used as needed. [Table 210](#) provides a brief selection of MIB modules to give you an idea of what is out there, also showing the module's group number (within the 1.3.6.1.2.1 name subtree):

Table 210: Some Common SNMP MIB Modules

MIB Module Name	Group Number	Description
ospf	14	Objects related to the Open Shortest Path First protocol.
bgp	15	Objects related to the Border Gateway Protocol .
rmon	16	Objects used as part of Remote Network Monitoring (RMON) , which we'll examine later in this chapter.
snmpDot3 RptrMgt	22	Objects related to IEEE 802.3 (Ethernet) repeaters.
rip-2	23	Objects used as part of version 2 of the Routing Information Protocol .
snmpDot3 MauMgt	26	Objects related to IEEE 802.3 (Ethernet) medium attachment units.
etherMIB	35	Ethernet-like generic objects.
mipMIB	44	Mobile IP objects.
ipMIB	48	Internet Protocol objects for SNMPv2.
tcpMIB	49	Transmission Control Protocol objects for SNMPv2.
udpMIB	50	User Datagram Protocol objects for SNMPv2.

There are of course, many, many more. The last three entries in the table above might seem a bit confusing, since there are already groups for IP, TCP and UDP in the first table above. The reason for these is that when the new modular architecture for MIB objects was created in SNMPv2, the definition of objects for the individual protocols that was part of the “one document” in SNMPv1 was separated out into individual MIB documents for consistency, and to allow them to be updated independently. In fact, the “base” SNMPv2 and SNMPv3 MIB documents now only define objects in the *system* and *snmp* groups.



Key Concept: MIB objects created early in SNMP's history were organized into *MIB object groups* that reside within *mib(1)* subtree, starting with identifier code 1.3.6.1.2.1. As the popularity of TCP/IP grew, it became impractical to centrally-define all MIB objects, so sets of objects particular to different hardware devices are now specified in *MIB modules*.

MIB Module Format

The format for MIB modules is described in the Structure of Management Information standard, version 2 (SMIv2). The document specifies how modules are to be defined in a way very similar to how objects themselves are defined, by listing a set of characteristics that must be included in each module description. The module fields are:

- ☉ **Module Name:** The name of the module. Remember that modules are really objects, syntactically, so like regular objects they have a textual object descriptor (like *tcpMIB*) and an object identifier (in the case of *tcpMIB*, the number 50).
- ☉ **Last Updated:** The date and time that the module was last revised.
- ☉ **Organization:** The name of the organization that is managing the development of the module.
- ☉ **Contact Information:** The name, address, telephone number and e-mail address of the “point person” for this module.
- ☉ **Description:** A description of the module.
- ☉ **Revision and Revision Description:** One *Revision* entry is placed for each revision of the module to show its history. Each entry has a description associated with it.

After the definition of the module itself, the objects in the module are described. For an example, see RFC 2012, which defines the SNMPv2 TCP MIB we've been discussing in this example.



TCP/IP Simple Network Management Protocol (SNMP) Protocol

The overall network management solution for TCP/IP networks is the Internet Standard Management Framework. In the last two subsections we have taken a look at the framework as a whole, and also discussed the two components that define the management information transmitted between TCP/IP devices to accomplish network management. The third major part of the SNMP Framework is the actual *Simple Network Management Protocol*, *SNMP*, which is responsible for moving management information between devices.

In this section, I describe the concepts and operation of the actual SNMP protocol. I begin with a brief overview and history of the protocol, discussing it in general terms. I then have two subsections that describe SNMP's operation in detail. The first covers the different operations performed by the protocol and how they work. The second discusses protocol messaging and message formats.



Background Information: Please be sure that you have a solid understanding of [SNMP Management Information Bases \(MIBs\)](#) and [MIB objects](#) before proceeding in this section.

SNMP Protocol Overview, History and General Concepts

I have described the [TCP/IP Internet Standard Management Framework \(SNMP Framework\)](#) as being *information-oriented*. A specific decision was made in the design of the SNMP Framework to decouple the management information conveyed between SNMP agents and SNMP managers from the protocol used to carry that information. This provides numerous benefits to the technology as a whole, chief among them flexibility and modularity.

In this model, the operation of the management protocol is not defined in terms of specific commands made to check the status of a device or change how it operates. Instead, the protocol is defined in terms of management information variables called *objects*, and a communication protocol that allows these objects to be either examined or changed by a network administrator. I describe this concept thoroughly in [the topic that overviews the SNMP Management Information Base \(MIB\) and the Structure of Management Information \(SMI\)](#).

The MIB and SMI spell out the rules for how MIB objects are created and described. These MIB objects describe the types of information that can be read from the device or written to the device. The last piece of the puzzle is the actual protocol that is responsible for these “read” and “write” operations. This is the *Simple Network Management Protocol* itself, which I give the somewhat redundant name *SNMP Protocol* to differentiate it from the SNMP Framework.

The result of the separation of the protocol from the management information it carries is that the protocol itself becomes significantly reduced in complexity. Instead of the SNMP Protocol having to define dozens or even hundreds of operations that specify particular network management functions, it only has to deal with the transmission of MIB object information between SNMP agents and managers. The SNMP Protocol does not itself pay attention to what is in these objects; it is merely concerned with moving them around. In some ways, the SNMP Protocol is the only really simple part of SNMP!

Early Development of SNMPv1

The history of the SNMP Protocol goes back to the predecessor of the SNMP Framework, the *Simple Gateway Monitoring Protocol (SGMP)*, which was defined in RFC 1028 in 1987. SGMP was designed as an interim solution for network management while larger issues were being explored as I explained in [the overview of the SNMP Framework](#). However, this standard is where many of the basic design concepts underlying the modern SNMP Protocol can be found.

The SGMP standard specified the basic design model used in SNMP, by describing the SGMP protocol in terms of only retrievals of, or alterations to, variables stored on an Internet gateway (router). The standard also outlines the small number of protocol operations that are still the basis for SNMP's operation today.

The first version of the SNMP Framework, SNMPv1, included the first formal definition of the SNMP Protocol, in RFC 1067 (later revised by RFCs 1098 and 1157). This standard refines the protocol operations given in the SGMP document. It makes the operation of the SNMP Protocol fit into the overall SNMP Framework, working with formally-defined MIB objects.

SNMPv2 and the Division of SNMP into Protocol Operations and Transport Mappings

When SNMPv2 was created, the single document describing the SNMP Protocol was split into two standards, to make the protocol more modular and better reflective of the layers used in internetworks. This division has been maintained in SNMPv3 as well. The two types of documents specify the following:

- ☉ **Protocol Operations:** The first document of the pair describes the actual mechanics by which MIB objects are moved between SNMP devices using particular SNMP message types. In SNMPv3 it is RFC 3416, *Version 2 of the Protocol Operations for the Simple Network Management Protocol (SNMP)*. When people talk about just “the SNMP standard”, this is the document they usually mean.
- ☉ **Transport Mappings:** The second document details how the SNMP protocol operations described in the first standard above can be transported over a variety of different protocol suites. By using the correct mapping, SNMP operations can be carried out using lower-layer technologies other than IP. This standard is represented in SNMPv3 by RFC 3417, *Transport Mappings for the Simple Network Management Protocol (SNMP)*.

I discuss transport mappings in a little more detail in [the topic on SNMP messaging](#), but since IP/UDP is by far the most common transport mechanism, there isn't a great deal to say about that aspect of the SNMP Protocol. The focus of most of our look at SNMP will concentrate on SNMP protocol operations: what messages are used, how they are structured and how they are exchanged. In examining these messages we will see the two main ways that information exchanges occur in SNMP (by polling and by interrupt) and also discover how the SNMP Protocol works with MIB objects.



Key Concept: The actual mechanism used to communicate management information between network management stations and managed devices is called the *Simple Network Management Protocol*, which may be called the *SNMP Protocol* to differentiate it from the SNMP Framework. It consists of a number of *protocol operations* that describe the actual message exchanges that take place between devices, and a set of *transport mappings* that define how these messages are carried over various types of internetworks. The Internet Protocol is the most common transport mapping used for SNMP.



SNMP Protocol Operations

The Simple Network Management Protocol (SNMP) is the protocol responsible for allowing network management stations on a TCP/IP internetwork to perform management tasks with managed devices. The core of the protocol consists of a set of *protocol operations* that allow management information to be exchanged between SNMP agents and managers. Having previously examined the generalities of SNMP and what MIB objects are, we can now get down to the “nitty gritty” of how management information is actually communicated using SNMP. Yes, finally you get to actually see how SNMP “works”.

In this section I provide a detailed description of the operations performed by the SNMP Protocol. I begin with a general description of how SNMP operates and the two basic methods devices use to communicate; I also describe SNMP's message classes. I then provide topics that describe in detail each of the basic operations performed in SNMP and the messages used for those purposes: basic request/response, table traversal, object modification, and notification. I conclude with a discussion of SNMP security issues and a summary of the security methods in each of the SNMP versions.

Note that the number and types of protocol operations in SNMP changed between SNMPv1 and SNMPv2. The operations defined in SNMPv2 have been carried forward into the newest version, SNMPv3. Most of the discussion focuses on SNMPv3 as the newest implementation, while mentioning what differences there are between it and the original and still widely-used SNMPv1.

SNMP Protocol General Operation, Communication Methods and Message Classes

The main function of the SNMP Protocol is to allow management information, in the form of Management Information Base (MIB) objects, to be communicated between SNMP-capable devices. The *protocol operations* of the SNMP Protocol are what describe how this communication is performed. Before looking at these operations individually in detail, it is instructive to take an overall look at information exchange methods used in SNMP.

SNMP Communication Methods

For SNMP to be useful in enabling the management of a network, it must allow a network administrator using a [network management station \(NMS\)](#) to easily check the status of SNMP agents in managed devices. In data communications, there are two general techniques that are used in a situation where one entity needs to be kept informed about activity or occurrences on another:

- ☉ **Poll-Driven:** This term refers to the general technique of having the one who wants the information ask for it; just like someone might conduct a political poll. In SNMP, the NMS would poll SNMP agents for information. A common “real life” example of polling is the model used by the regular mail service; every day you go to check your mailbox to see if you have any mail.

-
- ☉ **Interrupt-Driven:** This term refers to having a device with information that another needs to know decide to send the information of its own “volition”. In SNMP, this would refer to an SNMP agent sending information to an NMS without being asked. This is the model used by that most famous of “interrupters”, the telephone.

Which is “better”? My quotation marks give me away again. The usual answer applies here: neither is better nor worse universally, which is why both options exist. Due to the obvious strengths and weaknesses of these models, The SNMP Protocol is designed to use both. Polling is used for the periodic gathering of routine information, such as checking the usage statistics and general status of a device. Interrupts are used in the form of *traps* that a network administrator can set on a managed device. These traps cause an SNMP agent to interrupt an NMS when an event of import occurs.



Key Concept: SNMP uses two basic methods for exchanging management information. Routine communication uses a *poll-driven* technique, where the network management station requests information from managed nodes. An *interrupt-driven* model is also supported: in situations where a managed device needs to tell a management station immediately about an occurrence, it can send a *trap* message without waiting for a request from the management station.

SNMP Messages and Protocol Data Units (PDUs)

The actual communication of information in the SNMP Protocol is performed in a manner similar to most other protocols, through the exchange of SNMP messages. These messages are sometimes called *protocol data units* or *PDUs*. This is a term you may have heard used in other protocols, and is also part of [the formal definition of data encapsulation in the OSI Reference Model](#). A message is, of course, a “data unit” used by the “protocol”. SNMP messages all have “-PDU” at the ends of their names to identify them.

Some consider “protocol data unit” to be analogous to the military using “oblong metallic-headed manually-operated fastener acceleration device” to refer to a hammer. To be fair though, strictly speaking, in SMNP a PDU and a message are not exactly the same. The PDU is the higher-layer data that SNMP encapsulates, as described by the OSI model. The SNMP message format is a *wrapper* that encapsulates a PDU along with header fields, as I describe in [the section on SNMP messaging](#). However, the point of a message is to send a PDU, so the two are “close enough”, and the terms are sometimes used interchangeably.

SNMP PDU Classes

SNMPv1 originally defined six PDUs. The number of PDUs was expanded and some changes made to their name and use in SNMPv2 and SNMPv3. The current SNMP Framework categorizes the PDUs into different *classes*. These classes describe both the function of each message type and the kind of communication they use to perform their task (polling versus interrupting).

Table 211 shows the main SNMPv2/SNMPv3 PDU classes, describes them, and shows which PDUs are in each class in SNMPv2/SNMPv3. These classes were not used in SNMPv1 but for clarity I also show which messages from SNMPv1 fall into the classes conceptually:

Table 211: SNMP PDU (Message) Classes

SNMPv3 PDU Class	Description	SNMPv1 PDUs	SNMPv2/SNMPv3 PDUs
Read	Messages that read management information from a managed device using a polling mechanism.	<i>GetRequest-PDU</i> , <i>GetNextRequest-PDU</i>	<i>GetRequest-PDU</i> , <i>GetNextRequest-PDU</i> , <i>GetBulkRequest-PDU</i>
Write	Messages that change management information on a managed device to affect the device's operation.	<i>SetRequest-PDU</i>	<i>SetRequest-PDU</i>
Response	Messages sent in response to a previous request.	<i>GetResponse-PDU</i>	<i>Response-PDU</i>
Notification	Messages used by a device to send an interrupt-like notification to an SNMP manager.	<i>Trap-PDU</i>	<i>Trapv2-PDU</i> , <i>InformRequest-PDU</i>

The *GetBulkRequest-PDU* and *InformRequest-PDU* messages are new in SNMPv2/v3. The *GetResponse-PDU* message was renamed just *Response-PDU* (since it is in fact a response and not a message that “gets” anything), and the new *Trapv2-PDU* replaces *Trap-PDU*.

There are three other “special” classes defined by the current SNMP Framework that are of less interest to us because they don't define actively-used messages, but which I should mention for completeness. The *Internal* class contains a special message called *Report-PDU* defined for internal SNMP communication. The SNMP standards also provide two classes called *Confirmed* and *Unconfirmed*, used to categorize the messages in my table above based on whether or not they are acknowledged. The *Report-PDU*, *Trapv2-PDU*, and *Response-PDU* messages are considered *Unconfirmed* and the rest are *Confirmed*.

The next few topics will show how the major message types in the four main classes are used. Note that in general terms, all protocol exchanges in SNMP are described in terms of one **SNMP entity** sending messages to another. Most commonly, the entity sending requests is an SNMP manager and the one responding an SNMP agent, except for traps, which are sent by agents. For greater clarity, I try to use these more specific terms (manager or agent) when possible, rather than just “entity”.



Key Concept: SNMP messages consist of a set of fields wrapped around a data element called a *protocol data unit* or *PDU*. In some cases, the terms “message” and “PDU” are used interchangeably, though they are technically not the same. SNMP PDUs are arranged into *classes* based on their function.

SNMP Protocol Basic Request/Response Information Poll Using GetRequest and (Get)Response Messages

The obvious place to begin our detailed look at SNMP protocol operations is with the simplest type of information exchange. This would be a simple *poll* operation to read one or more management information variables, used by one **SNMP entity** (typically an SNMP manager) to request or read information from another entity (normally an SNMP agent on a managed device). SNMP implements this as a simple two-message request/response protocol exchange, similar the request/reply processes found in so many TCP/IP protocols.

This information request process typically begins with the user of an application wanting to check the status of a device or look at information about it. As we've seen, all this information is stored on the device in the form of **MIB objects**. The communication, therefore, takes the form of a request for particular MIB objects and a reply from the device containing those objects' values. In simplified form, the steps in the process are as follows (and as shown in [Figure 274](#)):

1. **SNMP Manager Creates *GetRequest-PDU***: Based on the information required by the application and user, the SNMP software on the network management station creates a *GetRequest-PDU* message. It contains the names of the MIB objects whose values the application wants to retrieve.
2. **SNMP Manager Sends *GetRequest-PDU***: The SNMP manager sends the PDU to the device that is being polled.
3. **SNMP Agent Receives and Processes *GetRequest-PDU***: The SNMP agent receives and processes the request. It looks at the list of MIB object names contained in the message and checks to see if they are valid (ones the agent actually implements). It looks up the value of each variable that was correctly specified.
4. **SNMP Agent Creates *Response-PDU***: The agent creates a *Response-PDU* to send back to the SNMP Manager. This message contains the values of the MIB objects requested and/or error codes to indicate any problems with the request, such as an invalid object name.
5. **SNMP Agent Sends *Response-PDU***: The agent sends the response back to the SNMP Manager.
6. **SNMP Manager Processes *Response-PDU***: The manager processes the information in the *Response-PDU* received from the agent.



Key Concept: The most basic type of communication in SNMP is an *information poll*, which allows a network management station to read one or more MIB objects from a managed node using a simple request/reply message exchange.

The *Response-PDU* message is called *GetResponse-PDU* in SNMPv1. Presumably, this name was chosen from the fact that it was a response to a get operation, to make the names *GetRequest-PDU* and *GetResponse-PDU* somewhat symmetric. The problem is that this name is confusing, for two reasons. First, it sounds to some people like the purpose of the PDU is to “get a response”. Second, the *GetResponse-PDU* was also

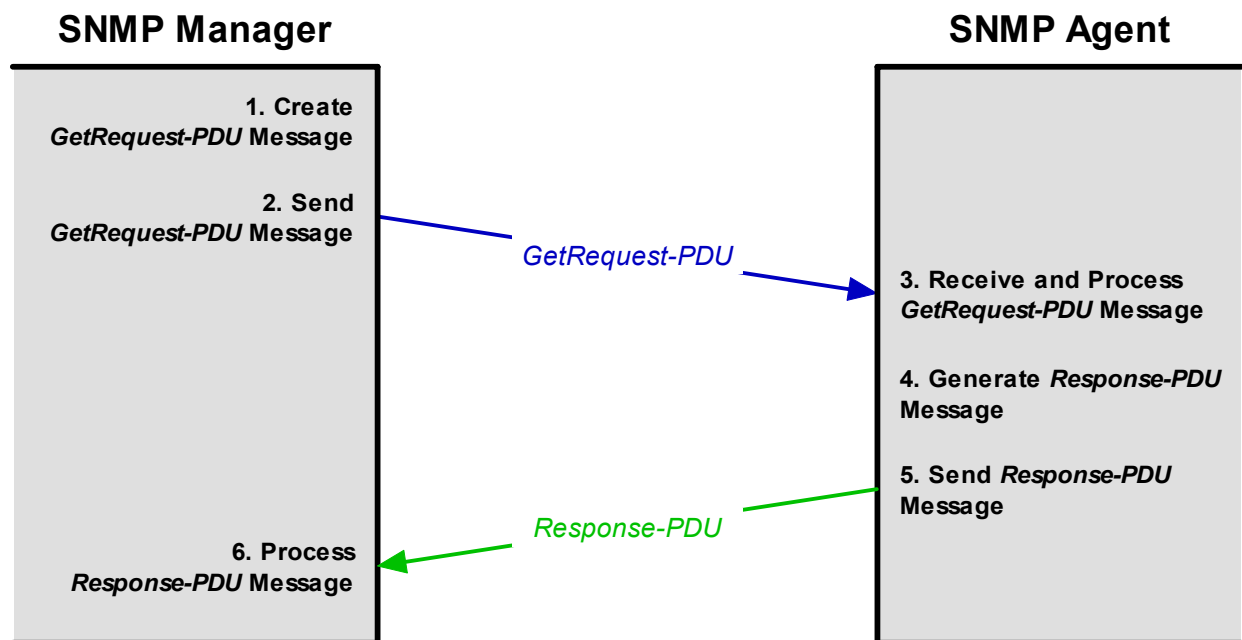

Figure 274: SNMP Information Poll Process

The basic SNMP information polling process involves a simple exchange of a *GetRequest-PDU* sent by an SNMP manager and a *Response-PDU* returned by an SNMP agent.

defined as the response message for operations other than “gets”, including the reply message for *SetRequest-PDU*. Having a “GetResponse” message be sent in reply to a “SetRequest” is disconcerting; the new name is more generic and avoids these problems.

SNMP Protocol Table Traversal Using *GetNextRequest* and *GetBulkRequest* Messages

The *GetRequest-PDU* message we examined [last topic](#) is the one used by applications to request values for regular, single variables in an SNMP managed object's management information base. As I mentioned in [the topic describing MIB objects](#), however, the Structure of Management Information (SMI) also allows a management information base to contain *tabular data*.

MIB tables are a useful way for a device to store and organize a set of related data items. It would be rather inefficient to try to structure these items just as collections of regular objects. For example, a device may have multiple IP addresses. It would be inefficient to define one MIB object called *ipAddr1*, and another called *ipAddr2*, and so on to store IP address information. Instead, an object called *ipAddrTable* is defined in the original SNMPv1 MIB, which specifies a table containing one or more entries called *ipAddrEntry*. Each entry contains the IP address and subnet mask for one of the interfaces of the device.

SNMPv1 Table Traversal Using *GetNextRequest*

There needs to be a way to let an SNMP manager may wish to read the contents of these tables from a device. This can be done using the regular *GetRequest-PDU* message, by specifying each entry in the table one after the other. However, this is somewhat crude, and it leaves a problem: the SNMP manager may not know how many entries are in the table, and therefore, how many entries it should request.

The problem of *table traversal* was addressed in SNMPv1 through the creation of a new message type called *GetNextRequest-PDU*. You can think of this as a “relative” version of the regular *GetRequest-PDU*. The *GetNextRequest-PDU* contains the name of a tabular variable, as well as a particular entry in the table. The device receiving the *GetNextRequest-PDU* uses this to look up the next value in the table and return it in a *GetResponse-PDU* message.

The actual protocol exchange is about the same as [that described in the previous topic](#): a request is sent by the SNMP manager and a reply returned by the SNMP agent. The difference is that instead of the SNMP agent returning the value for the variable specified, it returns the value of the **next** variable in the table. This is then used as the value for the next request, and so on, until the last entry in the table is reached. Once this happens and a *GetNextRequest-PDU* is sent that contains this last entry, the responding device indicates this by returning the MIB object that conceptually follows the table in the implementation of the management information base. This signals to the SNMP manager that the table has been fully traversed.



Key Concept: The SNMP *GetNextRequest-PDU* message allows a network management station to request a series of consecutive variables in a management information base. This is most commonly used to allow tabular data to be more easily retrieved without requiring that each variable in the table be individually specified.

SNMPv2/v3 Table Traversal Using *GetBulkRequest*

The *GetNextRequest-PDU* message is functional, but while it is more elegant than using regular *GetRequest-PDU* messages, it is not any more efficient—each entry in the table must still be requested one at a time. This means that retrieving the information in a table takes a long time, and also results in a great deal of traffic being generated due to the number of requests and replies that must be sent.

To make table traversal easier and more conservative of network resources, SNMPv2 introduced a new message type called *GetBulkRequest-PDU*. You can probably surmise the idea here from the name. Instead of specifying a particular MIB object to get or to “get next”, a *GetBulkRequest-PDU* allows an SNMP manager to send a single request that results in a number of entries in a table being returned in a *Response-PDU* message.

The *GetBulkRequest-PDU* is designed to allow both regular variable and tables to be retrieved in a single request. The PDU includes a list of objects, just as in a *GetRequest-PDU* or *GetNextRequest-PDU*. The list is organized so that regular objects appear first and table objects come afterwards. Two special parameters are included in the request, called *Non Repeaters* and *Max Repetitions*. The first of these specifies the number of non-repeating, regular objects to be retrieved; this is the number of regular objects at the start of the object list. The second specifies the number of iterations, or entries, to read for the remaining tabular objects.

For example, suppose an SNMP manager wanted to request 4 regular variables and 3 entries from a table. The *GetNextRequest-PDU* would contain five MIB object specifications, with the table last. The *Non Repeaters* field would be set to 4, and the *Max Repetitions* field set to 3.

The original method of traversing tables using *GetRequest-PDU* and *GetNextRequest-PDU* from SNMPv1 was retained in SNMPv2 and SNMPv3 when they were developed. However, the introduction of the more efficient *GetBulkRequest-PDU* means that *GetNextRequest-PDU* is not as important as it was in SNMPv1. Bear in mind, however, that using *GetBulkRequest-PDU* does require that the requesting entity know how many entries to ask for. So, some “trial and error” or multiple requests may be required to get a whole table if the number of entries is not known.



Key Concept: To improve the efficiency of table traversal, SNMPv2 introduced the *GetBulkRequest-PDU* message, which allows a network management station to request a sequence of MIB objects from a table using a single request to a managed node.

SNMP Protocol Object Modification Using SetRequest Messages

The *GetRequest-PDU*, *GetNextRequest-PDU*, and *GetBulkRequest-PDU* messages are the three members of the SNMP “Read” [class of PDUs](#)—they are used to let an SNMP manager read MIB objects from an MIB agent. The opposite function is represented by the SNMP “Write” class, which contains a single member: the SNMP *SetRequest-PDU* message.

The use of this PDU is fairly obvious; where one of the three *Get* PDUs specifies a variable whose value is to be retrieved, the *SetRequest-PDU* message contains a specification for variables whose values are to be modified by the network administrator. Remember that [SNMP does not include specific commands](#) to let a network administrator control a managed device. This is in fact the “control method”, by setting variables that affect the operation of the managed device.

The set process is the complement of the get process; the same basic idea, pretty much, but a reversal in how the object values “travel” and what is done with them. The process follows these steps (see [Figure 275](#)):

1. **SNMP Manager Creates *SetRequest-PDU*:** Based on the information changes specified by the user through the SNMP application, the SNMP software on the network management station creates a *SetRequest-PDU* message. It contains a set of MIB object names and the values to which they are to be set.
2. **SNMP Manager Sends *SetRequest-PDU*:** The SNMP manager sends the PDU to the device being controlled.
3. **SNMP Agent Receives and Processes *SetRequest-PDU*:** The SNMP agent receives and processes the set request. It examines each object in the request along with the value to which the object is to be set, and determines if the request should or should not be honored.
4. **SNMP Agent Makes Changes and Creates *Response-PDU*:** Assuming that the information in the request was correct (and any security provisions have been satisfied), the SNMP agent makes changes to its internal variables. The agent creates a *Response-PDU* to send back to the SNMP Manager, which either indicates that the request succeeded, or contains error codes to indicate any problems with the request found during processing.
5. **SNMP Agent Sends *Response-PDU*:** The agent sends the response back to the SNMP Manager.
6. **SNMP Manager Processes *Response-PDU*:** The manager processes the information in the *Response-PDU* to see the results of the set.

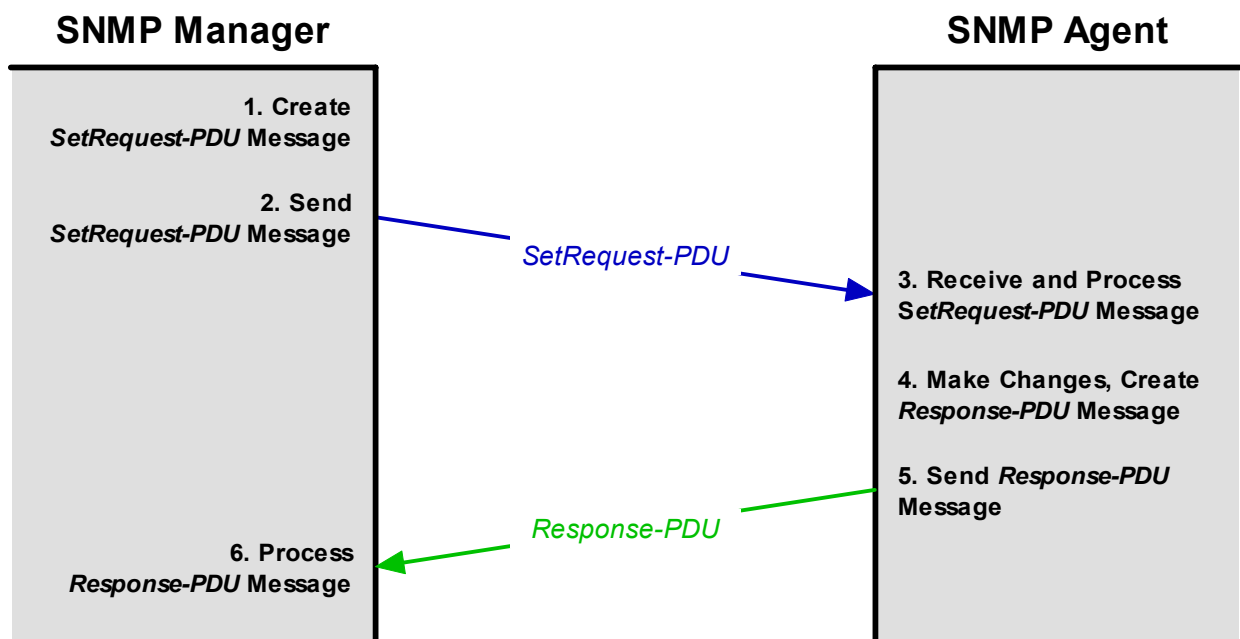

Figure 275: SNMP Object Modification Process

The communication process for setting a MIB object value is very similar to that used for reading one. The main difference is that, of course, the object values are sent from the SNMP Manager to the SNMP Agent, carried in the *SetRequest-PDU* message.

Verification of Object Modification Requests

Obviously, telling a device to change a variable's value is a more significant request than just asking the device to read the value. For this reason, the managed device must very carefully analyze and verify the information in the request to ensure that the request is valid. The checks performed include:

- ① Verifying the names of the objects to be changed.
- ② Verifying that the objects are allowed to be modified (based on their *Access* or *Max-Access* [object characteristic](#).)
- ③ Checking the value included in the request to ensure that its type and size are valid for the object to be changed.

This is also a place where [general protocol security issues](#) become more important.



Key Concept: SNMP network management stations control the operation of managed devices by changing MIB objects on those devices. This is done using the *SetRequest-PDU* message, which specifies the objects to be modified and their values.

SNMP Protocol Information Notification Using Trap(v2) and InformRequest Messages

The [first topic in this section](#) introduced the two basic methods of communicating information between SNMP devices: using polls or interrupts. All of the message types and exchanges we have examined thus far in this section have been poll-driven: they consist of an SNMP manager making a specific request that results in action being taken, and a response being generated by an SNMP agent.

The Need for Traps in SNMP

Polling is ideal for the exchange of routine information that needs to be gathered on a regular basis. For example, the regular *Get* requests could be used to verify the settings on a device, examine error counts over a period of time, or check its up-time or use statistics. And obviously, polling is the only real method for performing a *Set* operation, where data is changed.

But polling is not well-suited for important information that needs to be communicated quickly. The reason is that poll-driven communication is always initiated by the recipient of the information: the SNMP manager. If something significant occurs on a managed device that the manager wasn't expecting, the manager won't find out about it unless it specifically asks to see the variable that has changed. This means that important variables would need to be checked all the time by the SNMP manager, which is highly inefficient.

In the real world, using polling to implement situations where critical information needs to be sent would be like having the emergency response service in your town call everyone every hour to find out if they needed an ambulance or fire truck. Similarly, in SNMP, a mechanism was needed to let an SNMP agent initiate the communication of information. This capability was originally made part of the SNMPv1 protocol through the inclusion of the *Trap-PDU* message type.

In computer science, a *trap* is simply a set of conditions that a device monitors continuously. If the appropriate conditions occur, the trap is *triggered* and causes some sort of action to occur. In SNMP, traps are programmed into SNMP agents, and when they are triggered, an SNMP *Trap-PDU* message is sent to an SNMP Manager to inform it of the occurrence. Examples of traps in the SNMPv1 specification include ones that trigger in the event of a communication link failure, restart of the device, or an authentication problem.

Use of SNMP Trap and Trapv2 Messages

The communication in the case of a trap is trivial; the SNMP Agent sends the trap and the SNMP Manager is thereby considered “informed” of what happened. That's pretty much it. These are “Unconfirmed” messages and no reply is made back to the SNMP Agent. The triggering of the trap may lead the network administrator to take follow-up action at the device that sent the trap.

The designer of a particular management information base must determine what traps to create for a particular group of objects. The implementation must specify the conditions under which the traps will trigger, and also the destination to which the *Trap-PDU* message will be sent when this occurs. In SNMPv2, the original trap notification message was retained in the form of the *Trapv2-PDU* message.

Use of the SNMPv2 InformRequest Message

SNMPv2 also incorporates a second notification message type: *InformRequest-PDU*. This type of message is not the same as a trap, but it is related to traps for two reasons. First, both message types are used to communicate information without the recipient initiating the process, and second, the two messages are sometimes used in conjunction.

The purpose of the *InformRequest-PDU* is actually to facilitate the communication of information between network management stations. The SNMP Manager on one NMS can choose to “inform” another of some piece of information by sending an *InformRequest-PDU* to that other SNMP Manager. The receiving manager then replies back with a *Response-PDU* to the one that sent the *InformRequest-PDU*, confirming receipt of the inform message.

A common way that this message is used is to “spread the news” when a trap occurs. Suppose a device experiences a power failure, which results in a *Trapv2-PDU* being sent to NMS #1. The network administrator may want to set up NMS #1 so that receipt of particular traps causes the information in the trap to be “forwarded” to another. The *InformRequest-PDU* would be used to carry that information from NMS #1 to say, NMS #2.



Key Concept: SNMP managed devices can inform a network management station of an important occurrence by sending it a *Trap-PDU* or *Trapv2-PDU* message. Network administrators determine the circumstances under which one of these messages should be transmitted. SNMPv2 adds to this capability the *InformRequest-PDU* message, which can be used to propagate information about an event between management stations.

SNMP Protocol Security Issues and Methods

In [my description of the various SNMP versions](#), it's possible that I may have been a bit harsh on those who worked on SNMP during the 1990s. The proliferation of many SNMP version 2 variants really was unfortunate, and not something we often see in the world of TCP/IP. However, now that we've seen the sort of work that SNMP does, the need for security in the protocol would seem to be clear. Given that, and given the very low level of security in the initial SNMPv1 protocol, it's understandable to some extent why a conflict over security issues arose.

Why Security is Important in SNMP

The need for security in SNMP is obvious because the MIB objects being communicated contain critical information about network devices. We don't want just anyone “snooping” into our network to find out our IP addresses, or how long our machines have been running, or whether our links are down, or pretty much anything else. When it comes to [object write operations](#) using *SetRequest-PDU*, the concerned are magnified even more: we **definitely** don't want strangers being able to control or interfere with our managed devices by issuing bogus commands to change MIB objects that control device operation!

SNMPv1 Security

Unfortunately, the security incorporated into SNMPv1 was extremely limited; it really took the form of only one policy and one simple technology:

- ☉ **“Weak Objects”:** SNMP was created with the mindset that the MIB objects used in the protocol would be relatively *weak*. This means that the objects are designed so that any problems in working with them result in minimal damage. The policy of the designers of SNMP was that MIB objects that are normally read should not contain critical information, and objects that are written should not control critical functions.

So, a read-only MIB object containing a description of a machine is fine, but one containing the administrative password is **not**. Similarly, a read-write MIB object that controls when the computer next reboots is acceptable, but one that tells the object to reformat its hard disk is (definitely) not!

-
- **Community Strings:** All the devices in an SNMP network managed by a particular set of network management stations are considered to be in a “community”. Each SNMPv1 message sent between members of the community is identified by a *community string* that appears in a field in the message header. This string is like a simple password; any messages received with the wrong string will be rejected by the recipient.

These security features are better than nothing, but not much. The use of weak objects is comparable to a policy that says not to leave your car in front of the convenience store with the doors unlocked and the key in the ignition—it is basically saying “don't ask for trouble”. This is wise, but it's not a complete security solution. The community strings protect against obvious tampering in the form of unauthorized messages. However, the strings are sent in plain open text and can easily be discovered and then used to compromise the “community”. So this is like locking your doors when parking your car—it protects against the casual thief but not a pro.

Of course, for some people, not leaving their car running and locking the doors when they park are enough security, and SNMPv1's security was also sufficient for some users of SNMP. But in newer, larger internetworks, especially ones spanning large distances or using public carriers, SNMPv1 wasn't up to the task. This is why all that fun stuff occurred with SNMP version 2.

SNMPv2/v3 Security Methods

During the “evolution” of SNMPv2 variants, and eventually the creation of SNMPv3, several new security models were created to improve upon SNMPv1's security:

- **Party-Based Security Model:** This was the security model for the original SNMPv2 standard, now called *SNMPv2p*. A logical entity called a *party* is defined for communication that specifies a particular authentication protocol and a privacy (encryption) protocol. The information is used to verify that a particular request is authentic, and to ensure that the sender and receiver agree on how to encrypt and decrypt data.
- **User-Based Security Model (USM):** This was developed in the SNMPv2u variant and used in SNMPv2* (SNMPv2 asterisk); it eventually was adopted in SNMPv3. The idea here is to move away from tying security to the machines and instead use more traditional security based on access rights of a user of a machine. A variety of authentication and encryption protocols can be used to ensure access rights are respected and to protect message privacy. The method relies on time stamps, clock synchronization and other techniques to protect against certain types of attacks.
- **View-Based Access Control Model (VACM):** VACM is part of SNMPv3, and defines a method where more fine control can be placed on access to objects on a device. A *view* specifies a particular set of MIB objects that can be accessed by a particular group in a particular context. By controlling these views an administrator can manage what information is accessed by whom.

These descriptions are “grossly simplified”, to say the least. Security is probably the most complicated subtopic in networking, and describing these methods in detail would require dozens and dozens of topics. You can refer to the relevant standards if you want more information, though unless you are well-read on security topics, you will likely not be able to make heads or tails out of what is written in them.

Use of SNMP Security Methods

Party-based security pretty much died with SNMPv2p; USM and VACM are part of SNMPv3 and provide enhanced security for those who need it (though again, it's interesting to note how many networks continue to use SNMPv1, security warts and all.) SNMPv3 took another important security-related step in redefining the SNMP architecture to seamlessly support multiple security models. This enables different implementations to choose the security model that is best for them. USM is the default model in SNMPv3.



SNMP Protocol Messaging and Message Formats

As we saw extensively in [the previous section](#), the communication of management information is accomplished through the exchange of SNMP messages that contain *protocol data units (PDUs)*. Like the messages of most TCP/IP protocols, these PDUs are designed to use a particular field format, and are created, addressed and transported according to specific protocol rules. SNMP messages include fields that control the operation of the protocol, and carry a “payload” of management information in the form of [Management Information Base \(MIB\) objects](#).

In this section I describe the details of how messaging is accomplished in the SNMP Protocol. I begin with a general discussion of issues related to message generation, addressing and transport, and a description of how retransmission of messages is handled when necessary. I discuss the way fields are defined in SNMP messages and describe their general format, explaining the difference between the overall message and the PDU it contains. I then examine the message format used in all of the important SNMP versions, showing the structure of each message type and the fields used.

SNMP Protocol Message Generation, Addressing, Transport and Retransmission

The [section on SNMP protocol operations](#) described the way that SNMP messages are employed to communicate network management information. Those discussions focused primarily on the logical processes by which different tasks are accomplished using these messages. Let's now take a closer look at the lower-level details of exactly how these messages are created, addressed and sent by an SNMP device.

Message generation in SNMP is a bit different than the typical [TCP/IP client/server model](#) used for most other protocols. There aren't really any formal “clients” and “servers” in SNMP, since management information can be obtained from any device—it is distributed. Most of the message exchanges use a matched pair of request and reply messages. The [network management station \(NMS\)](#) usually *acts* as the client in these exchanges, sending a particular get or set request to an SNMP agent, which plays the role of server for the information it contains. However, SNMP agents aren't usually considered “servers” in the conventional sense of the term.

SNMP traps deviate from the normal request/reply model of message generation entirely. When a trap is triggered, an SNMP agent sends a trap message to a network management station on its own, not in reaction to receiving a request. Since trap messages are unconfirmed there is no reply. Note, however, that the SNMPv2/v3 *InformRequest-PDU* message *is* confirmed, and a response message is thus sent back to the NMS that generates it.

SNMP Transport Mappings

Once a message has been generated, it is sent using the protocols at the levels below the application layer where SNMP resides. As we saw in [the overview of the SNMP Protocol](#), the current SNMP standard set separates description of protocol operations and PDUs from

the methods used to actually send them. Starting with version 2, SNMP has defined several *transport mappings* that describe how SNMP PDUs can be sent over a variety of internet-working protocol suites, including TCP/IP, OSI, IPX/SPX (Novell) and Appletalk.

Many of the specific details of SNMP messaging depend on the transport mapping that is used in a particular implementation. SNMP is of course primarily used on TCP/IP internet-works, and TCP/IP is where our main interest lies in this part of the Guide. I will therefore continue this discussion by looking at transport issues when SNMP is used over IP.

SNMP Message Transport Using UDP

The standard IP transport mapping for SNMP calls for it to be carried using UDP. This decision goes back to the initial implementation of SNMPv1 (before there were distinct transport mappings.) UDP was likely chosen because it is more efficient for the simple request/reply messaging scheme SNMP uses; the many TCP features were not considered necessary and add overhead that SNMP's designers wanted to avoid. It is possible that TCP could be used to carry SNMP, defined as a different transport mapping, but I don't believe this is actually done.

Two [well-known UDP port numbers](#) are reserved for SNMP. The first is port 161, which is the “general-purpose” SNMP number. All devices that are set up to listen for SNMP requests—both agents and managers—listen on port 161. Each device receives any messages sent and replies back to the “client”, the SNMP entity that issued the request, which uses an [ephemeral port number](#) to identify the requesting process. The second UDP port number is 162, which is reserved for [SNMP traps](#). Having two numbers allows regular messages and traps to be kept separate. Normally only NMSes would listen on port 162, since agents are not recipients of traps.

The use of UDP allows SNMP information communication to be “streamlined”, since there is no need to establish a TCP connection, and since message headers are shorter and processing time slightly reduced. But the use of UDP introduces a couple of issues that SNMP implementations must be concerned with.

UDP Message Size Issues

The first issue is that of message length. SNMP PDUs can carry many MIB objects, which means they could potentially be rather large. However, UDP is limited in the size of message it can carry (where [TCP is not](#)). The standards specify that SNMP entities must accept messages up to at least 484 bytes in size. They also recommend that SNMP implementations be able to accept even larger messages, up to 1472 bytes, which would correspond to the largest size message that can be encapsulated in an Ethernet frame (1,500 bytes, allowing 20 bytes for the IP header and 8 for the UDP header.)

The use of the *GetBulkRequest-PDU* message type in SNMPv2/v3 requires particular care, since it allows a single request to result in many MIB objects being sent back in a response. The *Max Repetitions* parameter must be chosen conservatively so the SNMP agent doesn't try to send an enormous message that won't fit.

Dealing with Lost Transmissions

The second issue with UDP is the price we pay for its efficiency and simplicity: a lack of transport features. UDP doesn't guarantee data delivery or handle retransmissions, which means a request or reply could in theory be lost in transit. Only the device that initially sends a request can know if there was a problem with transport—it sends the request, and if it receives no reply knows either the request or response got lost. This puts the responsibility for retransmission on the part of the device that sends the request message.

NMSes sending requests to SNMP agents generally use a timer to keep track of how much time has elapsed since a request was sent. If the response doesn't arrive within a certain time interval, the request is sent again. Because of how SNMP works, having a request be received more than once accidentally will normally not cause any problems (a property known as *idempotence*). The NMS does need to employ an algorithm to ensure that it does not generate too many retransmissions and clog the network (especially since congestion might be causing the loss of its messages in the first place.)

Handling Lost Trap Messages

Since traps are unconfirmed, there is no way for the intended recipient of a trap PDU to know if it did not arrive, nor is there any way for the sender of the trap PDU to know. This is just a weakness in the protocol; the overall reliability of TCP/IP (and the underlying networks) ensures that these messages are not lost very often.



Key Concept: SNMP is designed with a separately-defined set of *protocol operations* and *transport mappings*, so it can be carried over many different internetworking technologies. The most common of these is transport mechanisms is TCP/IP, where SNMP makes use of *UDP* running over IP, for its efficient and simple communication. The lack of reliability features in UDP means that requests must be tracked by the device sending them and retransmitted if no reply is received. The limited size of UDP messages restricts the amount of information that can be sent in any SNMP PDU.

SNMP Message Field Definitions, General Message Format and Message Sections

To structure its messages for transport, SNMP uses a special field format, like most protocols. What's interesting about SNMP, however, is that its standards do not describe the SNMP message format using a simple list of fields the way most TCP/IP standards do. Instead, SNMP messages are defined using the same data description language (*Abstract Syntax Notation 1* or *ASN.1*) that is used to describe MIB objects.

The reason for this is that SNMP messages implement the various SNMP [protocol operations](#) with the ultimate goal of allowing MIB objects to be conveyed between SNMP entities. These MIB objects become fields within the messages to be sent. The MIB objects carried

in SNMP messages are defined using ASN.1 as described in the [Structure of Management Information \(SMI\)](#) standard. So it makes sense to define SNMP messages and all their fields using the same syntax.

Since all SNMP fields are defined like MIB objects, they are like objects in that they have certain characteristics. Specifically, each field has a name, and its contents are described using one of the standard [SMI data types](#). So, unlike normal message formats where each field has just a name and a length, an SNMP message format field has a name and a *syntax*, such as *Integer*, *Octet String* or *IpAddress*. The syntax of the field defines its length and how it is formatted and used.

Just as regular message formats use integers to represent specific values (for example, the numeric *Opcode* field in the [DNS message header](#), which indicates the DNS message type), this can be done in SNMP using an enumerated integer type. An example would be the *Error Status* field, where a range of integer values represents different error conditions.

The decision to define SNMP messages using ASN.1 allows the message format description to be consistent with how the objects in the format are described, which is nice. Unfortunately, it means that the field formats are very hard to determine from the standards, because they are not described in one place. Instead, the overall message format is defined as a set of components; those components contain subcomponents that may be defined elsewhere, and so on. In fact, the full message format isn't even defined in one standard; parts are spread across several standards. So you can't look in one place and see the whole message format.

Well, I should say that you can't if you use the standards, but you can if you look here. To make things easier for you, I have converted these "distributed" syntax descriptions into the same tabular field formats I use throughout the rest of this Guide. I will begin here by describing the general format used for SNMP messages, and in the next three topics explore the more specific formats used in each version of SNMP.

General Message Format

To understand SNMP messages, it is important that we first grasp the difference between SNMP *messages* and SNMP *protocol data units (PDUs)*. We've seen in looking at SNMP protocol operations that the two terms are often used interchangeably. This is because each message carries one PDU, and the PDU is the most important part of the message.

However, strictly speaking, an SNMP PDU and an SNMP message are not exactly the same. The PDU is the actual piece of information that is being communicated between SNMP entities. It is carried *within* the SNMP message along with a number of header fields, which are used to carry identification and security information. Thus, conceptually, the SNMP message format can be considered to have two overall sections:

- ① **Message Header:** Contains fields used to control how the message is processed, including fields for implementing SNMP security.
- ② **Message Body (PDU):** Contains the main portion of the message. In this case, the message body is the protocol data unit (PDU) being transmitted.

The overall SNMP message is sometimes called a *wrapper* for the PDU, since it encapsulates the PDU and precedes it with additional fields. The distinction between the PDU and the message format as a whole began as a formality in SNMP version 1, but became quite important in later versions. The reason is that it allows the fields used for basic protocol operations (which are in the PDU) to be kept separate from fields used to implement security features. In SNMPv2, the implementation of security became a very big deal indeed, as we will see, so this flexibility was quite important.

General PDU Format

The fields in each PDU depend on the PDU type, but can again be divided into the following general substructure:

- ☉ **PDU Control Fields:** A set of fields that describe the PDU and communicate information from one SNMP entity to another.
- ☉ **PDU Variable Bindings:** A set of descriptions of the MIB objects in the PDU. Each object is described as a “binding” of a name to a value.

Each PDU will follow this general structure, which is shown in [Figure 276](#), differing only in the number of control fields, the number of variable bindings, and how they are used. In theory, each PDU could have a different message format using a distinct set of control fields, but in practice, most PDUs in a particular SNMP version use the same control fields (though there are exceptions.)

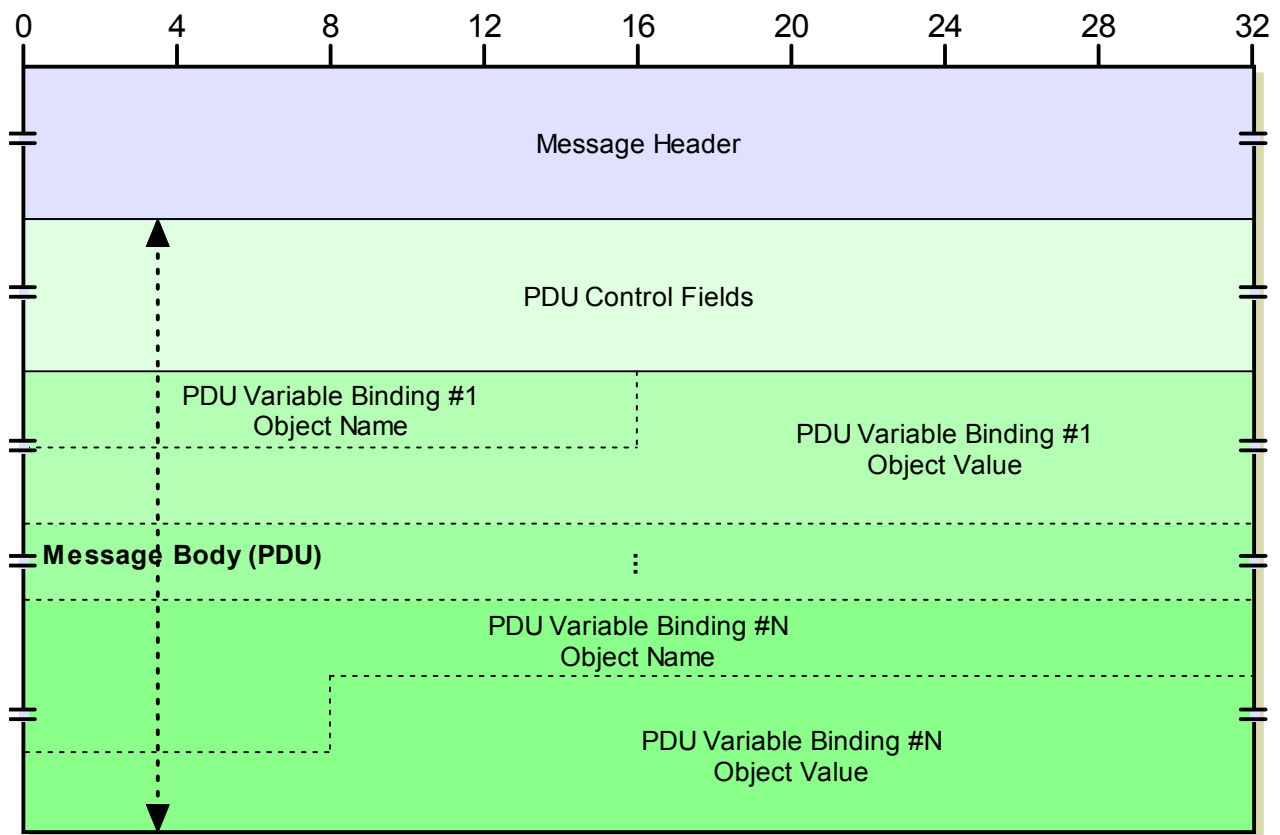

Figure 276: SNMP General Message Format

Each variable binding describes one MIB object. The binding consists of a pair of subfields, one specifying the name of the object in standard SNMP object identifier notation, and one its value, formatted to match the object's SMI syntax. For example, if the object is of type *Integer*, the value field would be 4 bytes wide and contain a numeric integer value. [Table 212](#) describes the subfield format for each PDU variable binding.

Table 212: SNMP Variable Binding Format

Subfield Name	Syntax	Size (bytes)	Description
Object Name	Sequence of <i>Integer</i>	Variable	Object Name: The numeric object identifier of the MIB object, specified as a sequence of integers. For example, the object <i>sysLocation</i> has the object identifier 1.3.6.1.2.1.1.6, so it would be specified as "1 3 6 1 2 1 1 6" using ASN.1
Object Value	Variable	Variable	Object Value: In any type of "get" request, this subfield is a "placeholder"; it is structured using the appropriate syntax for the object but has no value (since the "get" request is asking for that value!) In a "set" request (SetRequest-PDU) or in a reply message carrying requested data (GetResponse-PDU or Response-PDU), the value of the object is placed here.



Key Concept: The general format of SNMP messages consists of a *message header* and a *message body*. The body of the message is also called the *protocol data unit* or *PDU*, and contains a set of *PDU control fields* and a number of *variable bindings*. Each variable binding describes one MIB object and consists of the object's name and value.

SNMP Version 1 (SNMPv1) Message Format

The SNMP general message format was, of course, first used to define the format of messages in the original SNMP Protocol, SNMP version 1 (SNMPv1). This first version of SNMP is probably best known for its relative simplicity, compared to the versions that followed it. This is reflected in its message format, which is quite straight-forward.

The general message format in SNMPv1 is a “wrapper” consisting of a small header and an encapsulated PDU. Not very many header fields were needed in SNMPv1 because the community-based security method in SNMPv1 is very rudimentary. Thus, the short overall format for SNMPv1 messages shown in [Table 213](#) and [Figure 277](#).

Table 213: SNMP Version 1 (SNMPv1) General Message Format

Field Name	Syntax	Size (bytes)	Description
Version	<i>Integer</i>	4	Version Number: Describes the SNMP version number of this message; used for ensuring compatibility between versions. For SNMPv1, this value is actually 0 , not 1.
Community	<i>Octet String</i>	Variable	Community String: Identifies the SNMP community in which the sender and recipient of this message are located. This is used to implement the simple SNMP community-based security mechanism
PDU	—	Variable	Protocol Data Unit: The PDU being communicated as the body of the message.

SNMPv1 PDU Formats

All of the PDUs in SNMPv1 have the same format, with one exception: *Trap-PDU*. The exact semantics of each field in the PDU depends on the particular message. For example, the *ErrorStatus* field only has meaning in a reply and not a request, and object values are used differently in requests and replies as well.

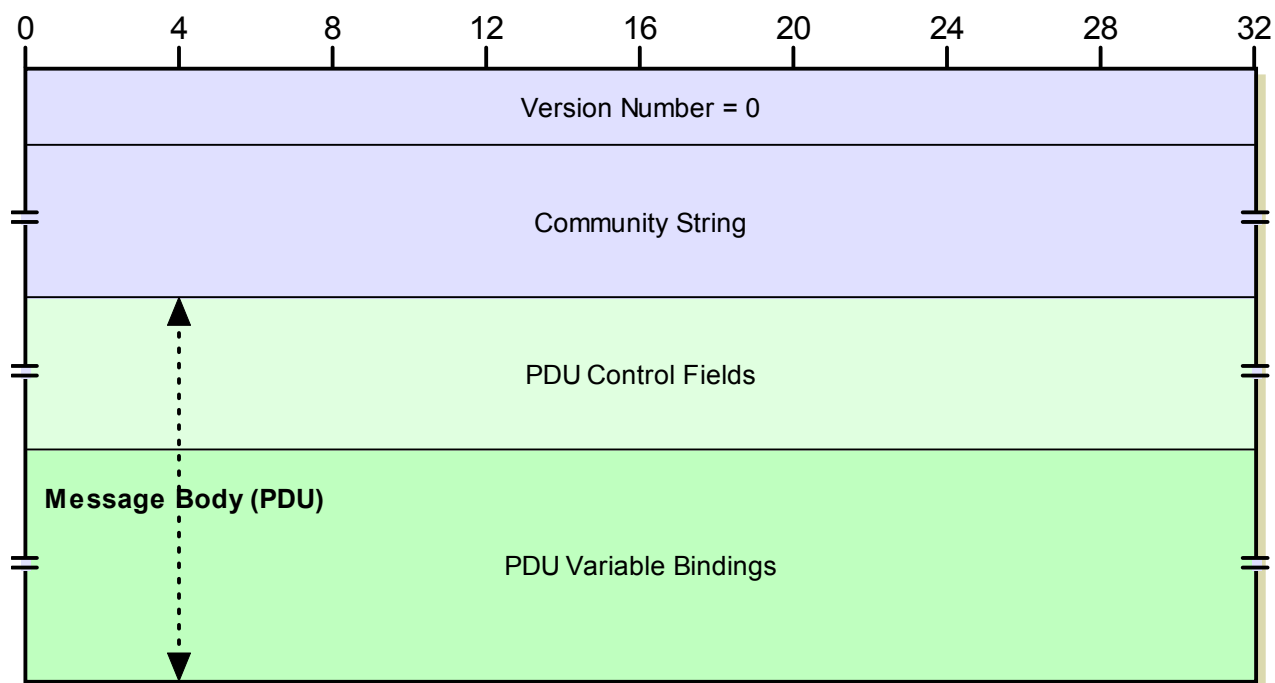

Figure 277: SNMP Version 1 (SNMPv1) General Message Format

SNMPv1 Common PDU Format

Table 214 and Figure 278 show the common format for most of the SNMPv1 PDUs: *GetRequest-PDU*, *GetNextRequest-PDU*, *SetRequest-PDU* and *GetResponse-PDU*:

Table 214: SNMP Version 1 (SNMPv1) Common PDU Format (Page 1 of 2)

Field Name	Syntax	Size (bytes)	Description										
PDU Type	<i>Integer (Enumerated)</i>	4	<p>PDU Type: An integer value that indicates the PDU type:</p> <table border="1"> <thead> <tr> <th>PDU Type Value</th> <th>PDU Type</th> </tr> </thead> <tbody> <tr> <td>0</td> <td><i>GetRequest-PDU</i></td> </tr> <tr> <td>1</td> <td><i>GetNextRequest-PDU</i></td> </tr> <tr> <td>2</td> <td><i>GetResponse-PDU</i></td> </tr> <tr> <td>3</td> <td><i>SetRequest-PDU</i></td> </tr> </tbody> </table>	PDU Type Value	PDU Type	0	<i>GetRequest-PDU</i>	1	<i>GetNextRequest-PDU</i>	2	<i>GetResponse-PDU</i>	3	<i>SetRequest-PDU</i>
PDU Type Value	PDU Type												
0	<i>GetRequest-PDU</i>												
1	<i>GetNextRequest-PDU</i>												
2	<i>GetResponse-PDU</i>												
3	<i>SetRequest-PDU</i>												
Request ID	<i>Integer</i>	4	<p>Request Identifier: A number used to match requests with replies. It is generated by the device that sends a request and copied into this field in a <i>GetResponse-PDU</i> by the responding SNMP entity.</p>										

Table 214: SNMP Version 1 (SNMPv1) Common PDU Format (Page 2 of 2)

Field Name	Syntax	Size (bytes)	Description																					
Error Status	<i>Integer (Enumerated)</i>	4	<p>Error Status: An integer value that is used in a <i>GetResponse-PDU</i> to tell the requesting SNMP entity the result of its request. A value of zero indicates that no error occurred; the other values indicate what sort of error happened:</p> <table border="1"> <thead> <tr> <th>Error Status Value</th> <th>Error Code</th> <th>Description</th> </tr> </thead> <tbody> <tr> <td>0</td> <td><i>noError</i></td> <td>No error occurred. This code is also used in all request PDUs, since they have no error status to report.</td> </tr> <tr> <td>1</td> <td><i>tooBig</i></td> <td>The size of the <i>GetResponse-PDU</i> would be too large to transport.</td> </tr> <tr> <td>2</td> <td><i>noSuchName</i></td> <td>The name of a requested object was not found.</td> </tr> <tr> <td>3</td> <td><i>badValue</i></td> <td>A value in the request didn't match the structure that the recipient of the request had for the object. For example, an object in the request was specified with an incorrect length or type.</td> </tr> <tr> <td>4</td> <td><i>readOnly</i></td> <td>An attempt was made to set a variable that has an <i>Access</i> value indicating that it is read-only.</td> </tr> <tr> <td>5</td> <td><i>genErr</i></td> <td>An error other than one of the preceding four specific types occurred.</td> </tr> </tbody> </table>	Error Status Value	Error Code	Description	0	<i>noError</i>	No error occurred. This code is also used in all request PDUs, since they have no error status to report.	1	<i>tooBig</i>	The size of the <i>GetResponse-PDU</i> would be too large to transport.	2	<i>noSuchName</i>	The name of a requested object was not found.	3	<i>badValue</i>	A value in the request didn't match the structure that the recipient of the request had for the object. For example, an object in the request was specified with an incorrect length or type.	4	<i>readOnly</i>	An attempt was made to set a variable that has an <i>Access</i> value indicating that it is read-only.	5	<i>genErr</i>	An error other than one of the preceding four specific types occurred.
Error Status Value	Error Code	Description																						
0	<i>noError</i>	No error occurred. This code is also used in all request PDUs, since they have no error status to report.																						
1	<i>tooBig</i>	The size of the <i>GetResponse-PDU</i> would be too large to transport.																						
2	<i>noSuchName</i>	The name of a requested object was not found.																						
3	<i>badValue</i>	A value in the request didn't match the structure that the recipient of the request had for the object. For example, an object in the request was specified with an incorrect length or type.																						
4	<i>readOnly</i>	An attempt was made to set a variable that has an <i>Access</i> value indicating that it is read-only.																						
5	<i>genErr</i>	An error other than one of the preceding four specific types occurred.																						
Error Index	<i>Integer</i>	4	<p>Error Index: When <i>Error Status</i> is non-zero, this field contains a pointer that specifies which object generated the error. Always zero in a request.</p>																					
Variable Bindings	Variable	Variable	<p>Variable Bindings: A set of name-value pairs identifying the MIB objects in the PDU, and in the case of a <i>SetRequest-PDU</i> or <i>GetResponse-PDU</i>, containing their values. See the general message format topic for more on these bindings.</p>																					

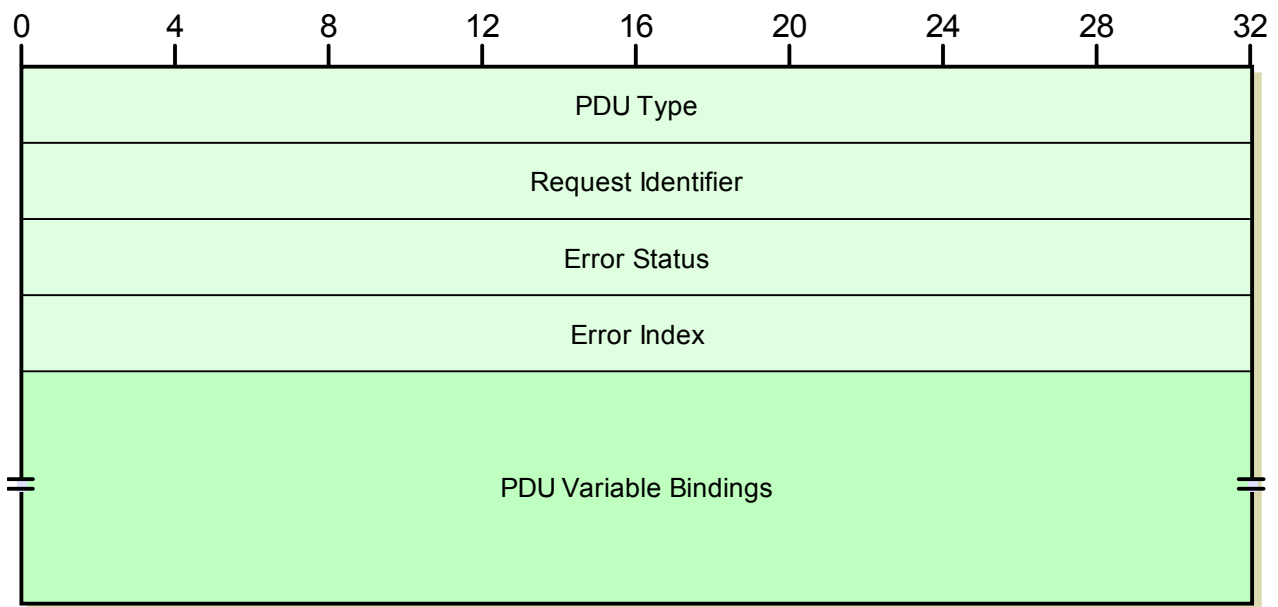

Figure 278: SNMP Version 1 (SNMPv1) Common PDU Format

SNMPv1 Trap-PDU Format

Table 215 and Figure 279 show the special format for the SNMPv1 *Trap-PDU*:

Table 215: SNMP Version 1 (SNMPv1) *Trap-PDU* Format

Field Name	Syntax	Size (bytes)	Description
PDU Type	<i>Integer (Enumerated)</i>	4	PDU Type: An integer value that indicates the PDU type, which is 4 for a <i>Trap-PDU</i> message.
Enterprise	Sequence of <i>Integer</i>	Variable	Enterprise: An object identifier for a group, which indicates the type of object that generated the trap.
Agent Addr	<i>NetworkAddress</i>	4	Agent Address: The IP address of the SNMP agent that generated the trap. This is of course also in the IP header at lower levels but inclusion in the SNMP message format allows for easier trap logging within SNMP. Also, in the case of a multihomed host, this specifies the preferred address.
Generic Trap	<i>Integer (Enumerated)</i>	4	Generic Trap Code: A code value specifying one of a number of predefined “generic” trap types.
Specific Trap	<i>Integer</i>	4	Specific Trap Code: A code value indicating an implementation-specific trap type.
Time Stamp	<i>TimeTicks</i>	4	Time Stamp: The amount of time since the SNMP entity sending this message last initialized or reinitialized. Used to time stamp traps for logging purposes.
Variable Bindings	Variable	Variable	Variable Bindings: A set of name-value pairs identifying the MIB objects in the PDU. See the general message format topic for more on these bindings.

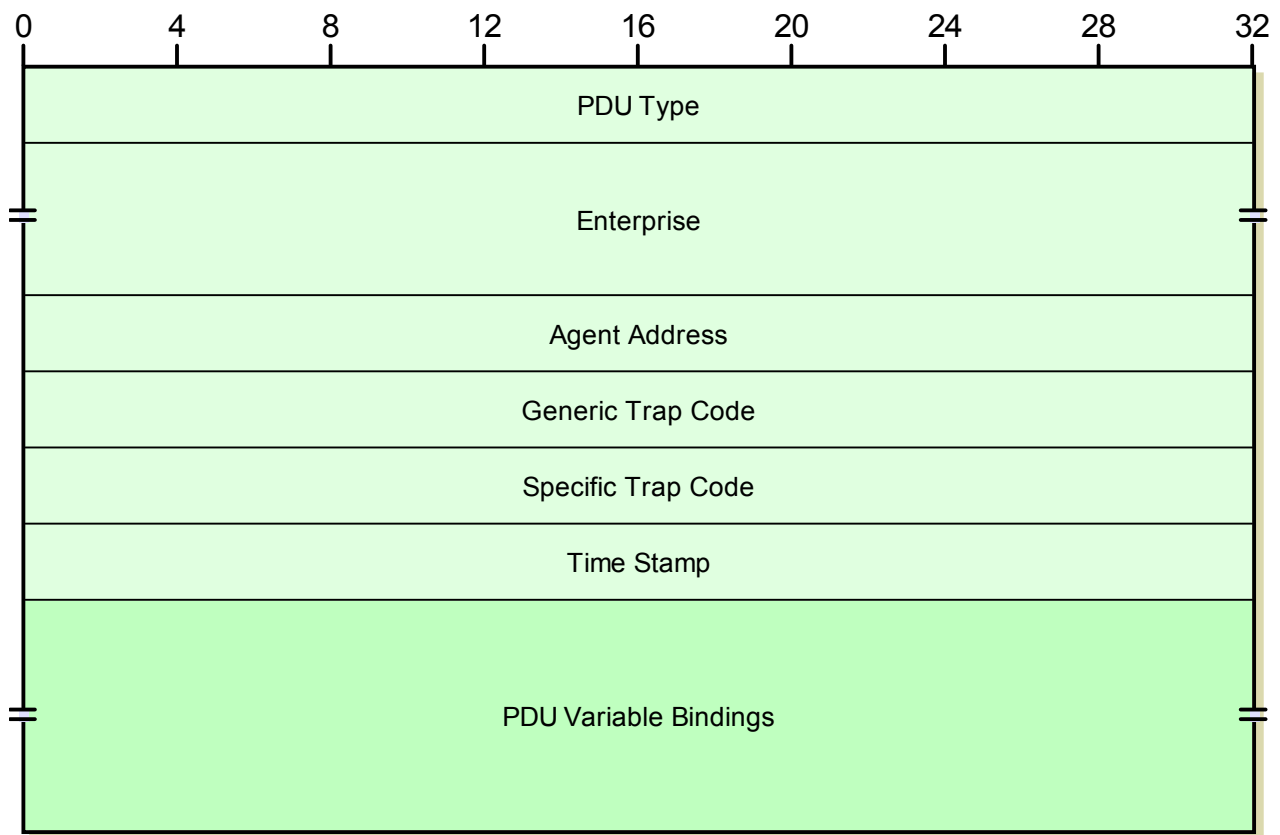

Figure 279: SNMP Version 1 (SNMPv1) Trap-PDU Format

SNMP Version 2 (SNMPv2) Message Formats

After SNMP version 1 had been in use for several years, certain issues with it were noticed and areas for improvement identified. This led to the development of the original SNMP version 2, which was intended to enhance SNMPv1 in many areas, including MIB object definitions, protocol operations and security. This last area, security, led to the proliferation of SNMPv2 version “variants” that I described in [the topic on SNMP versions](#).

Since there are in fact several different “SNMPv2”s, there are also several message formats for SNMPv2, not just one. This is confusing enough, but would be even worse without the modular nature of SNMP messages “coming to the rescue”. The protocol operations in SNMPv2 were changed from SNMPv1, which necessitated some modifications to the format of SNMPv2 PDUs. However, the protocol operations are the same for all the SNMPv2 variations. The differences **between** SNMPv2 variants are in the areas of security implementation. Thus, the result of this is that the **PDU** format is the same for all the SNMPv2 types, while the overall **message** format differs for each variant. (This is why the distinction between a PDU and a message is not just an academic one!)

During the SNMPv2 “divergence”, four variations were defined: the original SNMPv2 (SNMPv2p); community-based SNMPv2 (SNMPv2c), user-based SNMPv2 (SNMPv2u) and “SNMPv2 star” (SNMPv2*). Of these, the first three were [documented in sets of SNMP RFC](#)

standards, the fourth was not. The structure of the overall message format for each variant is discussed in an administrative or security standard for the variation in question, which makes reference to the shared SNMPv2 standard for the PDU format (RFC 1905).

The overall message formats for SNMPv2p, SNMPv2c and SNMPv2u are as follows:

SNMP Version 2 (SNMPv2p) Message Format

The party-based security model is quite complex, but the basic messaging in this version is described through the definition of a *management communication*, which describes the source and destination party and makes reference to a *context* for the communication. The overall message format is described in detail in RFC 1445. This information is summarized in [Table 216](#) and shown graphically in [Figure 280](#).

Table 216: SNMP Version 2 (SNMPv2p) General Message Format

Field Name	Syntax	Size (bytes)	Description
Version	<i>Integer</i>	4	Version Number: Describes the SNMP version number of this message; used for ensuring compatibility between versions. For SNMPv2p, this value is 2.
Dst Party	Sequence of <i>Integer</i>	Variable	Destination Party: An object identifier that specifies the party that is the intended recipient of the message.
Src Party	Sequence of <i>Integer</i>	Variable	Source Party: An object identifier that specifies the party that is the sender of the message.
Context	Sequence of <i>Integer</i>	Variable	Context: Defines a set of MIB object resources that is accessible by a particular entity.
PDU	—	Variable	PDU: The protocol data unit of the message.

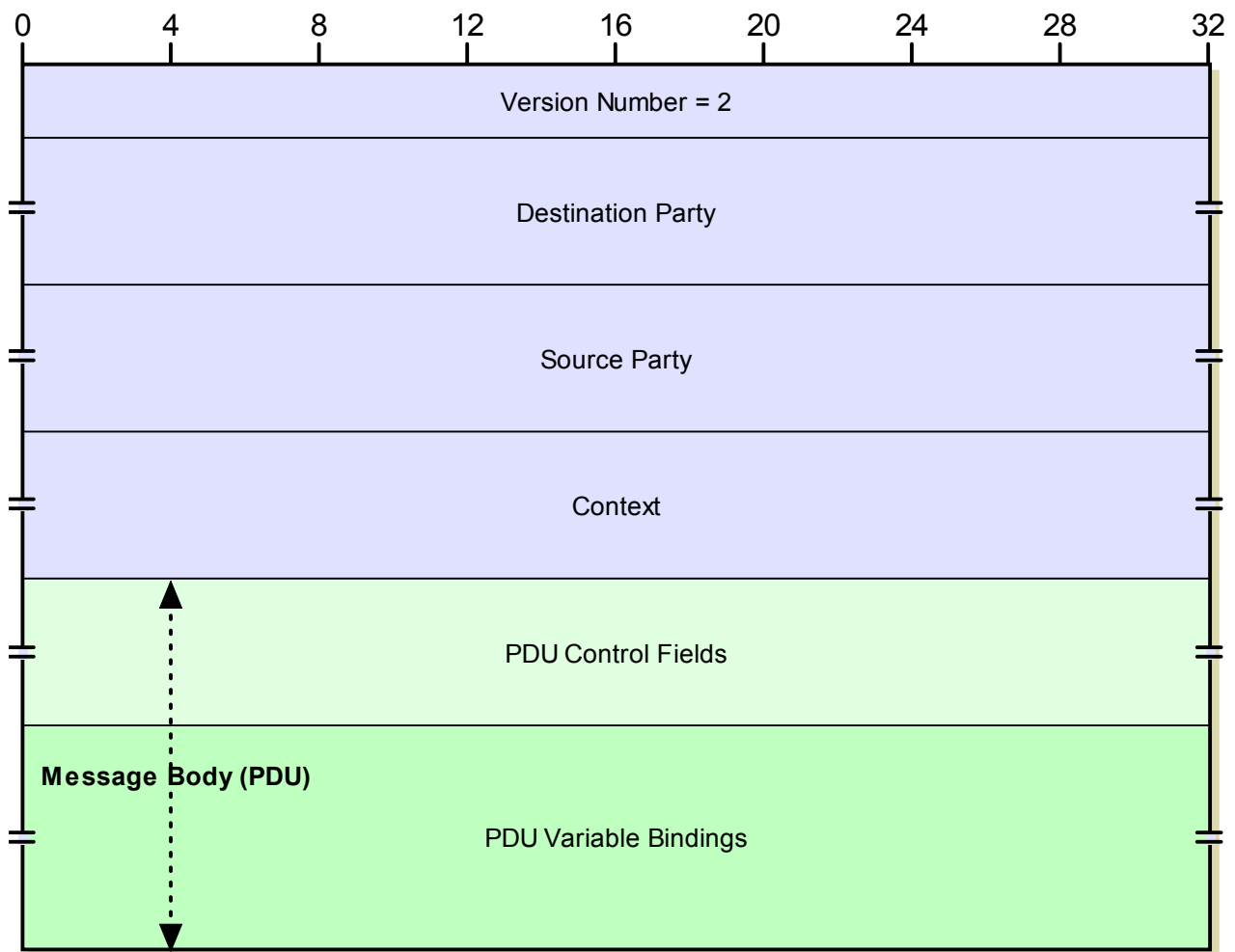

Figure 280: SNMP Version 2 (SNMPv2p) General Message Format

Community-Based SNMP Version 2 (SNMPv2c) Message Format

This version of SNMPv2 was intended to keep the new protocol enhancements introduced by SNMPv2p but go back to the simple SNMPv1 security model. As such, the defining document for SNMPv2c, RFC 1901, specifies that its overall message format is the same as that of SNMPv1, except that the version number is changed. This is shown in [Table 217](#) and [Figure 281](#).

Table 217: Community-Based SNMP Version 2 (SNMPv2c) General Message Format

Field Name	Syntax	Size (bytes)	Description
Version	<i>Integer</i>	4	Version Number: Describes the SNMP version number of this message; used for ensuring compatibility between versions. For SNMPv2c, this value is 1.
Community	<i>Octet String</i>	Variable	Community String: Identifies the SNMP community in which the sender and recipient of this message are located.
PDU	—	Variable	Protocol Data Unit: The PDU being communicated as the body of the message.

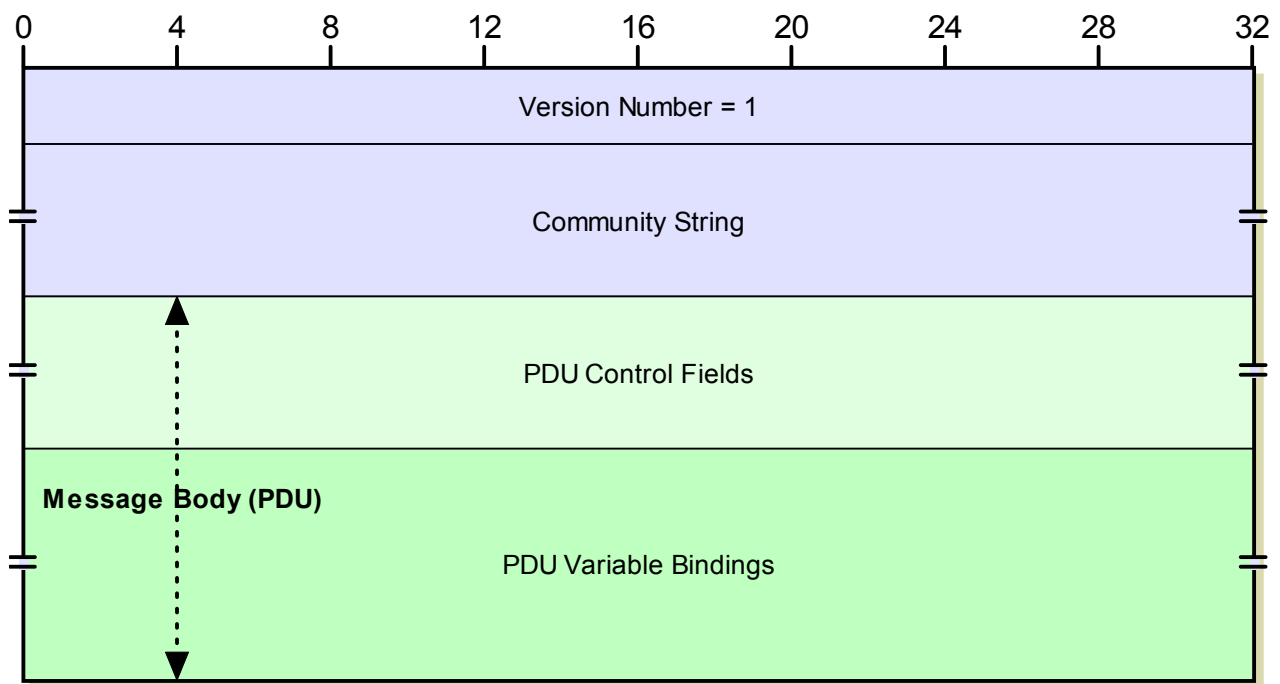

Figure 281: Community-Based SNMP Version 2 (SNMPv2c) General Message Format

User-Based SNMP Version 2 (SNMPv2u) Message Format

SNMPv2u was defined as an optional security model at the time that SNMPv2c was standardized. RFC 1910 defines the user-based security model and the message format described in [Table 218](#) and [Figure 282](#).

Table 218: User-Based SNMP Version 2 (SNMPv2u) General Message Format

Field Name	Syntax	Size (bytes)	Description																																				
Version	<i>Integer</i>	4	Version Number: Describes the SNMP version number of this message; used for ensuring compatibility between versions. For SNMPv2u, this value is 2. Note that this is the same value as used for SNMPv2p.																																				
Parameters	<i>Octet String</i>	Variable	<p>Parameters: A string of parameters used to implement the user-based security model, which is itself non-trivial to describe. Very briefly, these parameters are:</p> <table border="1"> <thead> <tr> <th>Subfield Name</th> <th>Size (bytes)</th> <th>Description</th> </tr> </thead> <tbody> <tr> <td>Model</td> <td>1</td> <td>Model Number: Set to 1 to identify the user-based model.</td> </tr> <tr> <td>QoS</td> <td>1</td> <td>Quality of Service: Indicates whether authentication and/or privacy (encryption) have been used, and whether generation of a <i>Report-PDU</i> is allowed.</td> </tr> <tr> <td>Agent ID</td> <td>12</td> <td>Agent Identifier: The identifier of the agent sending the message. Used to defeat replay attacks and certain other types of security attacks.</td> </tr> <tr> <td>Agent Boots</td> <td>4</td> <td>Agent Number Of Boots: The number of times the agent has been booted or rebooted since its Agent ID was set; used to defeat certain security attacks.</td> </tr> <tr> <td>Agent Time</td> <td>4</td> <td>Agent Time Since Last Boot: The number of seconds since the last boot of this agent. Again, used to defeat replay and other security attacks.</td> </tr> <tr> <td>Max Size</td> <td>2</td> <td>Maximum Message Size: The maximum size of message that the sender of this message can receive.</td> </tr> <tr> <td>User Len</td> <td>1</td> <td>User Length: The length of the <i>User Name</i> field below.</td> </tr> <tr> <td>User Name</td> <td>Variable (1 to 16)</td> <td>User Name: The name of the user on whose behalf the message is being sent.</td> </tr> <tr> <td>Auth Len</td> <td>1</td> <td>Authentication Digest Length: The length of the <i>Auth Digest</i> field below.</td> </tr> <tr> <td>Auth Digest</td> <td>Variable (0 to 255)</td> <td>Authentication Digest: An authentication value used to verify the identity and genuineness of this message, when authentication is used.</td> </tr> <tr> <td>Context Selector</td> <td>Variable (0 to 40)</td> <td>Context Selector: A string that is combined with the <i>Agent ID</i> to specify a particular context that contains the management information referenced by this message.</td> </tr> </tbody> </table>	Subfield Name	Size (bytes)	Description	Model	1	Model Number: Set to 1 to identify the user-based model.	QoS	1	Quality of Service: Indicates whether authentication and/or privacy (encryption) have been used, and whether generation of a <i>Report-PDU</i> is allowed.	Agent ID	12	Agent Identifier: The identifier of the agent sending the message. Used to defeat replay attacks and certain other types of security attacks.	Agent Boots	4	Agent Number Of Boots: The number of times the agent has been booted or rebooted since its Agent ID was set; used to defeat certain security attacks.	Agent Time	4	Agent Time Since Last Boot: The number of seconds since the last boot of this agent. Again, used to defeat replay and other security attacks.	Max Size	2	Maximum Message Size: The maximum size of message that the sender of this message can receive.	User Len	1	User Length: The length of the <i>User Name</i> field below.	User Name	Variable (1 to 16)	User Name: The name of the user on whose behalf the message is being sent.	Auth Len	1	Authentication Digest Length: The length of the <i>Auth Digest</i> field below.	Auth Digest	Variable (0 to 255)	Authentication Digest: An authentication value used to verify the identity and genuineness of this message, when authentication is used.	Context Selector	Variable (0 to 40)	Context Selector: A string that is combined with the <i>Agent ID</i> to specify a particular context that contains the management information referenced by this message.
			Subfield Name	Size (bytes)	Description																																		
			Model	1	Model Number: Set to 1 to identify the user-based model.																																		
			QoS	1	Quality of Service: Indicates whether authentication and/or privacy (encryption) have been used, and whether generation of a <i>Report-PDU</i> is allowed.																																		
			Agent ID	12	Agent Identifier: The identifier of the agent sending the message. Used to defeat replay attacks and certain other types of security attacks.																																		
			Agent Boots	4	Agent Number Of Boots: The number of times the agent has been booted or rebooted since its Agent ID was set; used to defeat certain security attacks.																																		
			Agent Time	4	Agent Time Since Last Boot: The number of seconds since the last boot of this agent. Again, used to defeat replay and other security attacks.																																		
			Max Size	2	Maximum Message Size: The maximum size of message that the sender of this message can receive.																																		
			User Len	1	User Length: The length of the <i>User Name</i> field below.																																		
			User Name	Variable (1 to 16)	User Name: The name of the user on whose behalf the message is being sent.																																		
			Auth Len	1	Authentication Digest Length: The length of the <i>Auth Digest</i> field below.																																		
			Auth Digest	Variable (0 to 255)	Authentication Digest: An authentication value used to verify the identity and genuineness of this message, when authentication is used.																																		
Context Selector	Variable (0 to 40)	Context Selector: A string that is combined with the <i>Agent ID</i> to specify a particular context that contains the management information referenced by this message.																																					
PDU	—	Variable	Protocol Data Unit: The PDU being communicated as the body of the message. This may be in either encrypted or unencrypted form.																																				

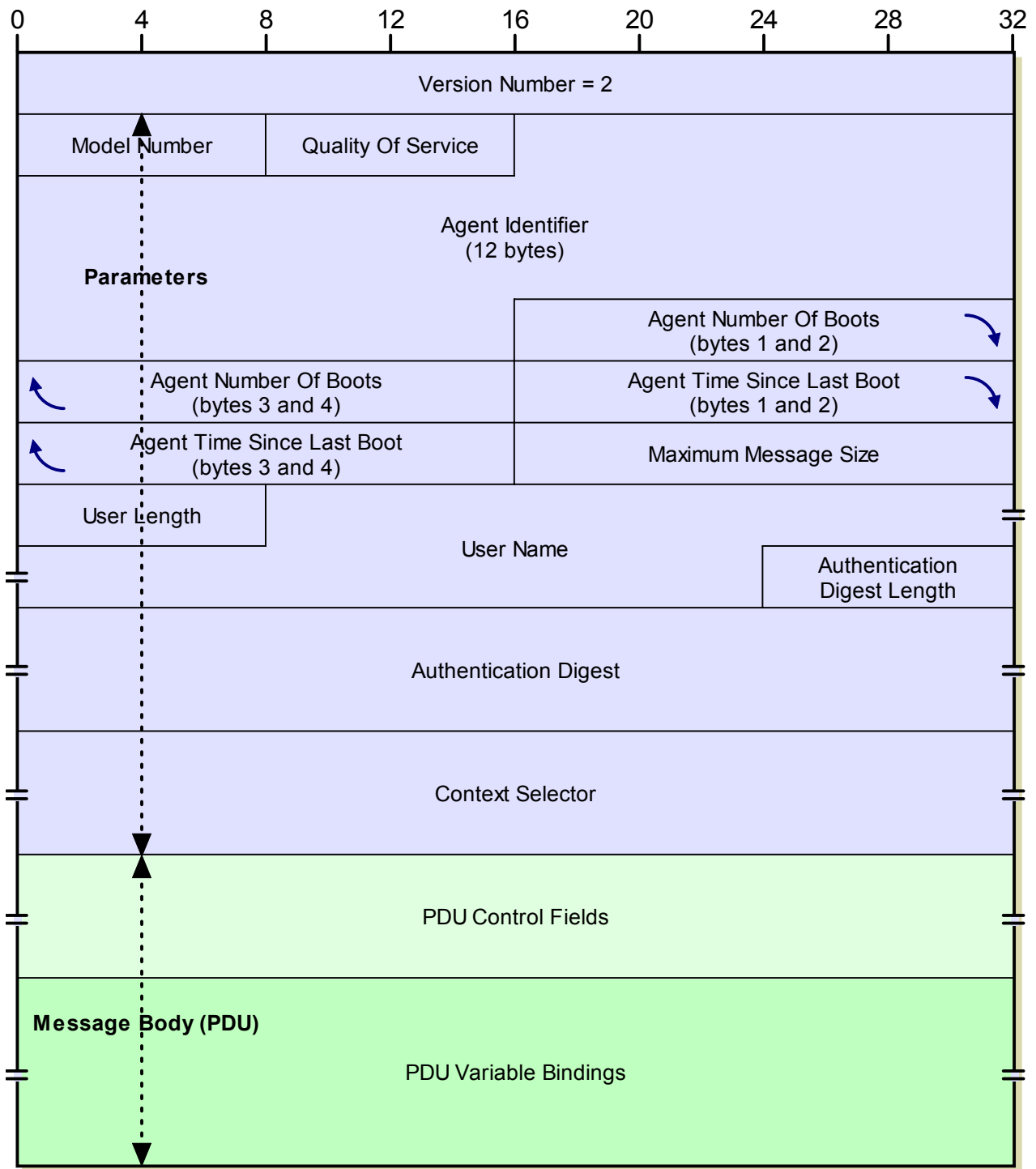

Figure 282: User-Based SNMP Version 2 (SNMPv2u) General Message Format

SNMPv2 PDU Formats

The format of protocol data units in SNMPv2 is described in RFC 1905, and is similar to that of SNMPv1. The format for all PDUs in SNMPv2 is the same, except for the *GetBulkRequest-PDU* message. (Oddly, this includes the *Trapv2-PDU* message, even though the *Trap-PDU* message in SNMPv1 used a distinct format).

SNMPv2 Common PDU Format

Table 219 and Figure 283 show this common PDU format. Table 220 contains a listing of the different values for the *Error Status* field and how they are interpreted.

Table 219: SNMP Version 2 (SNMPv2) Common PDU Format (Page 1 of 2)

Field Name	Syntax	Size (bytes)	Description																				
PDU Type	Integer (Enumerated)	4	<p>PDU Type: An integer value that indicates the PDU type:</p> <table border="1"> <thead> <tr> <th>PDU Type Value</th> <th>PDU Type</th> </tr> </thead> <tbody> <tr> <td>0</td> <td><i>GetRequest-PDU</i></td> </tr> <tr> <td>1</td> <td><i>GetNextRequest-PDU</i></td> </tr> <tr> <td>2</td> <td><i>Response-PDU</i></td> </tr> <tr> <td>3</td> <td><i>SetRequest-PDU</i></td> </tr> <tr> <td>4</td> <td>Obsolete, not used (this was the old <i>Trap-PDU</i> in SNMPv1)</td> </tr> <tr> <td>5</td> <td><i>GetBulkRequest-PDU</i> (has its own format, see below)</td> </tr> <tr> <td>6</td> <td><i>InformRequest-PDU</i></td> </tr> <tr> <td>7</td> <td><i>Trapv2-PDU</i></td> </tr> <tr> <td>8</td> <td><i>Report-PDU</i></td> </tr> </tbody> </table>	PDU Type Value	PDU Type	0	<i>GetRequest-PDU</i>	1	<i>GetNextRequest-PDU</i>	2	<i>Response-PDU</i>	3	<i>SetRequest-PDU</i>	4	Obsolete, not used (this was the old <i>Trap-PDU</i> in SNMPv1)	5	<i>GetBulkRequest-PDU</i> (has its own format, see below)	6	<i>InformRequest-PDU</i>	7	<i>Trapv2-PDU</i>	8	<i>Report-PDU</i>
PDU Type Value	PDU Type																						
0	<i>GetRequest-PDU</i>																						
1	<i>GetNextRequest-PDU</i>																						
2	<i>Response-PDU</i>																						
3	<i>SetRequest-PDU</i>																						
4	Obsolete, not used (this was the old <i>Trap-PDU</i> in SNMPv1)																						
5	<i>GetBulkRequest-PDU</i> (has its own format, see below)																						
6	<i>InformRequest-PDU</i>																						
7	<i>Trapv2-PDU</i>																						
8	<i>Report-PDU</i>																						
Request ID	Integer	4	<p>Request Identifier: A number used to match requests with replies. It is generated by the device that sends a request and copied into this field in a <i>Response-PDU</i> by the responding SNMP entity.</p>																				
Error Status	Integer (Enumerated)	4	<p>Error Status: An integer value that is used in a <i>Response-PDU</i> to tell the requesting SNMP entity the result of its request. A value of zero indicates that no error occurred; the other values indicate what sort of error happened.</p> <p>Note that the first six values (0 to 5) are maintained as used in SNMPv1 for compatibility, but SNMPv2 adds many new error codes that provide more specific indication of the exact nature of an error in a request. The <i>genErr</i> code is still used only when none of specific error types (either the old codes or the new ones) apply.</p> <p>Since there are so many different <i>Error Status</i> codes, I have listed them separately in Table 220.</p>																				

Table 219: SNMP Version 2 (SNMPv2) Common PDU Format (Page 2 of 2)

Field Name	Syntax	Size (bytes)	Description
Error Index	Integer	4	Error Index: When <i>Error Status</i> is non-zero, this field contains a pointer that specifies which object generated the error. Always zero in a request.
Variable Bindings	Variable	Variable	Variable Bindings: A set of name-value pairs identifying the MIB objects in the PDU, and in the case of messages other than requests, containing their values. See the general message format topic for more on these bindings.

Table 220: SNMP Version 2 (SNMPv2) PDU Error Status Field Values (Page 1 of 2)

Error Status Value	Error Code	Description
0	noError	No error occurred. This code is also used in all request PDUs, since they have no error status to report.
1	tooBig	The size of the <i>Response-PDU</i> would be too large to transport.
2	noSuchName	The name of a requested object was not found.
3	badValue	A value in the request didn't match the structure that the recipient of the request had for the object. For example, an object in the request was specified with an incorrect length or type.
4	readOnly	An attempt was made to set a variable that has an <i>Access</i> value indicating that it is read-only.
5	genErr	An error occurred other than one indicated by a more specific error code in this table.
6	noAccess	Access was denied to the object for security reasons.
7	wrongType	The object type in a variable binding is incorrect for the object.
8	wrongLength	A variable binding specifies a length incorrect for the object.
9	wrongEncoding	A variable binding specifies an encoding incorrect for the object.
10	wrongValue	The value given in a variable binding is not possible for the object.
11	noCreation	A specified variable does not exist and cannot be created.
12	inconsistentValue	A variable binding specifies a value that could be held by the variable but cannot be assigned to it at this time.
13	resource-Unavailable	An attempt to set a variable required a resource that is not available.
14	commitFailed	An attempt to set a particular variable failed.
15	undoFailed	An attempt to set a particular variable as part of a group of variables failed, and the attempt to then undo the setting of other variables was not successful.
16	authorization-Error	A problem occurred in authorization.

Table 220: SNMP Version 2 (SNMPv2) PDU Error Status Field Values (Page 2 of 2)

Error Status Value	Error Code	Description
17	notWritable	The variable cannot be written or created.
18	inconsistentName	The name in a variable binding specifies a variable that does not exist.

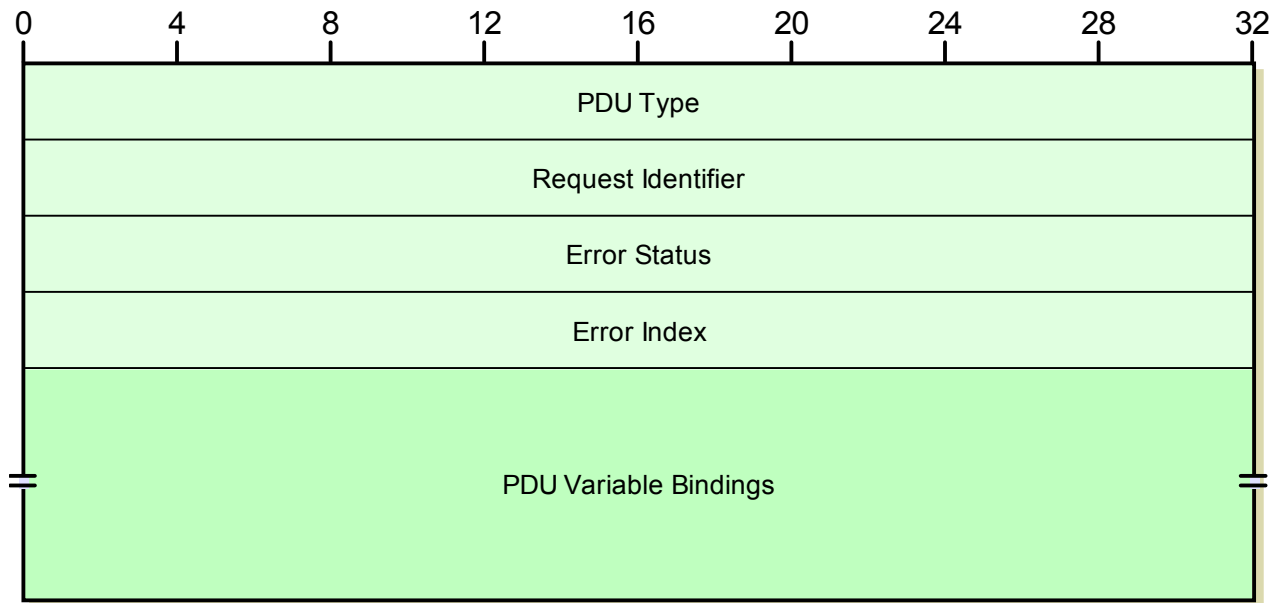

Figure 283: SNMP Version 2 (SNMPv2) Common PDU Format

SNMPv2 *GetBulkRequest-PDU* Format

The special format of the SNMPv2 *GetBulkRequest-PDU* message is shown in [Table 221](#) and [Figure 284](#).

Table 221: SNMP Version 2 (SNMPv2) *GetBulkRequest-PDU* Format (Page 1 of 2)

Field Name	Syntax	Size (bytes)	Description
<i>PDU Type</i>	<i>Integer (Enumerated)</i>	4	<i>PDU Type:</i> An integer value that indicates the PDU type, which is 5 for a <i>GetBulkRequest-PDU</i> message.
<i>Request ID</i>	<i>Integer</i>	4	<i>Request Identifier:</i> A number used to match requests with replies. It is generated by the device that sends a request and copied into this field in a <i>Response-PDU</i> by the responding SNMP entity.
<i>Non Repeaters</i>	<i>Integer</i>	4	<i>Non Repeaters:</i> Specifies the number of non-repeating, regular objects at the start of the variable list in the request.

Table 221: SNMP Version 2 (SNMPv2) *GetBulkRequest-PDU* Format (Page 2 of 2)

Field Name	Syntax	Size (bytes)	Description
Max Repetitions	<i>Integer</i>	4	Max Repetitions: The number of iterations in the table to be read for the repeating objects that follow the non-repeating objects.
Variable Bindings	Variable	Variable	Variable Bindings: A set of name-value pairs identifying the MIB objects in the PDU. See the general message format topic for more on these bindings.

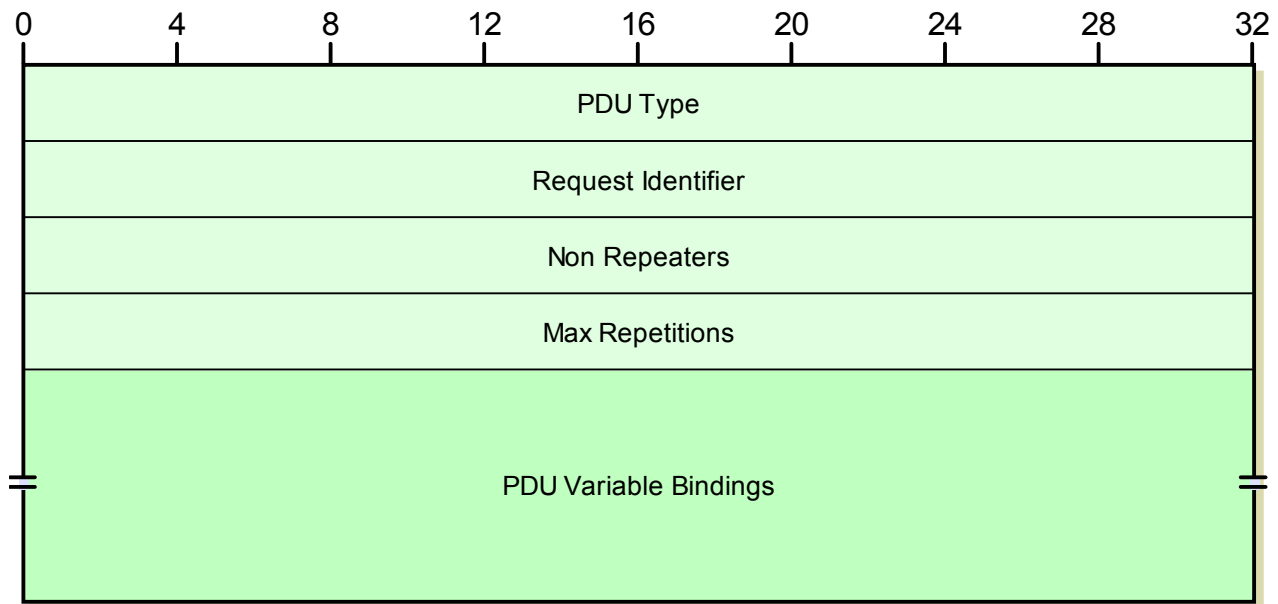

Figure 284: SNMP Version 2 (SNMPv2) *GetBulkRequest-PDU* Format



Note: [The topic on SNMP table traversal](#) contains full details on how *Non Repeaters* and *Max Repetitions* are used.

SNMP Version 3 (SNMPv3) Message Format

In the late 1990s, SNMP version 3 was created to resolve the problems that occurred with the [many different variations of SNMPv2](#). The SNMPv3 Framework adopts many components that were created in SNMPv2, including the SNMPv2 protocol operations, PDU types and PDU format. Amongst the significant changes made in SNMPv3 include a more flexible way of defining security methods and parameters, to allow the coexistence of multiple security techniques.

The general message format for SNMPv3 still follows the same idea of an overall message “wrapper” that contains a header and an encapsulated PDU. However, in version 3 this concept is further refined. The fields in the header have themselves been divided into those dealing with security and those that do not deal with security matters. The “non-security” fields are common to all SNMPv3 implementations, while the use of the security fields can be tailored by each SNMPv3 security model, and processed by the module in an SNMP entity that deals with security. This solution provides considerable flexibility while avoiding the problems that plagued SNMPv2.

The overall SNMPv3 message format is described in RFC 3412, which describes version 3 message processing and dispatching. It is shown in [Table 222](#) and [Figure 285](#).

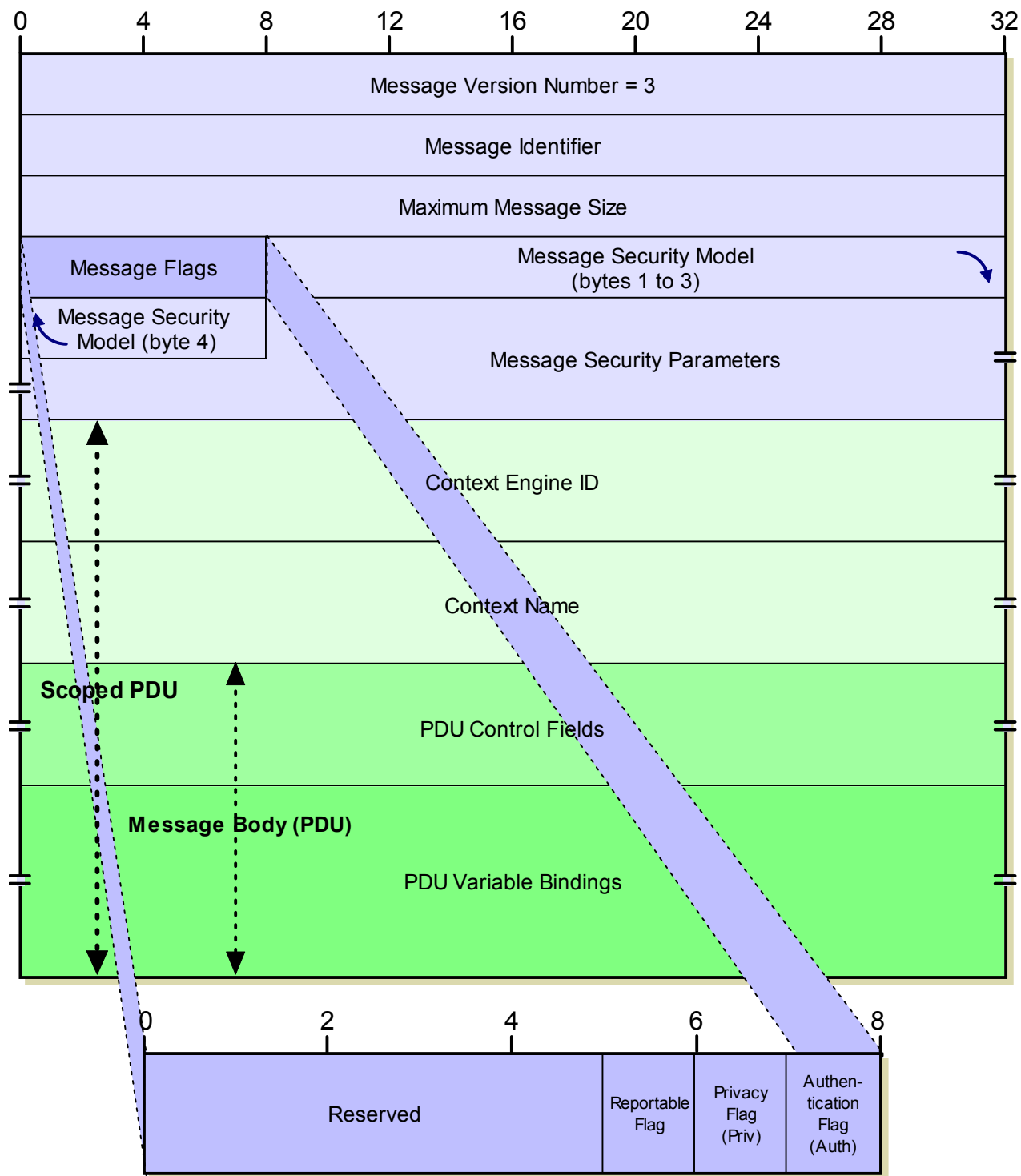

Figure 285: SNMP Version 3 (SNMPv3) General Message Format

Table 222: SNMP Version 3 (SNMPv3) General Message Format (Page 1 of 2)

Field Name	Syntax	Size (bytes)	Description															
Msg Version	<i>Integer</i>	4	Message Version Number: Describes the SNMP version number of this message; used for ensuring compatibility between versions. For SNMPv3, this value is 3.															
Msg ID	<i>Integer</i>	4	Message Identifier: A number used to identify an SNMPv3 message and to match response messages to request messages. The use of this field is similar to that of the <i>Request ID</i> field in the PDU format (see Table 219), but they are not identical. This field was created to allow matching at the message processing level regardless of the contents of the PDU, to protect against certain security attacks. Thus, <i>Msg ID</i> and <i>Request ID</i> are used independently.															
Msg Max Size	<i>Integer</i>	4	Maximum Message Size: The maximum size of message that the sender of this message can receive. Minimum value of this field is 484.															
Msg Flags	<i>Octet String</i>	1	<p>Message Flags: A set of flags that controls processing of the message. The current substructure of this field is:</p> <table border="1"> <thead> <tr> <th>Subfield Name</th> <th>Size (bytes)</th> <th>Description</th> </tr> </thead> <tbody> <tr> <td>Reserved</td> <td>5/8 (5 bits)</td> <td>Reserved: Reserved for future use.</td> </tr> <tr> <td>Reportable Flag</td> <td>1/8 (1 bit)</td> <td>Reportable Flag: When set to 1, a device receiving this message must send back a <i>Report-PDU</i> whenever conditions arise where such a PDU should be generated.</td> </tr> <tr> <td>Priv Flag</td> <td>1/8 (1 bit)</td> <td>Privacy Flag: When set to 1, indicates that encryption was used to protect the privacy of the message. May not be set to 1 unless <i>Auth Flag</i> is also set to 1.</td> </tr> <tr> <td>Auth Flag</td> <td>1/8 (1 bit)</td> <td>Authentication Flag: When set to 1, indicates that authentication was used to protect the authenticity of this message.</td> </tr> </tbody> </table>	Subfield Name	Size (bytes)	Description	Reserved	5/8 (5 bits)	Reserved: Reserved for future use.	Reportable Flag	1/8 (1 bit)	Reportable Flag: When set to 1, a device receiving this message must send back a <i>Report-PDU</i> whenever conditions arise where such a PDU should be generated.	Priv Flag	1/8 (1 bit)	Privacy Flag: When set to 1, indicates that encryption was used to protect the privacy of the message. May not be set to 1 unless <i>Auth Flag</i> is also set to 1.	Auth Flag	1/8 (1 bit)	Authentication Flag: When set to 1, indicates that authentication was used to protect the authenticity of this message.
Subfield Name	Size (bytes)	Description																
Reserved	5/8 (5 bits)	Reserved: Reserved for future use.																
Reportable Flag	1/8 (1 bit)	Reportable Flag: When set to 1, a device receiving this message must send back a <i>Report-PDU</i> whenever conditions arise where such a PDU should be generated.																
Priv Flag	1/8 (1 bit)	Privacy Flag: When set to 1, indicates that encryption was used to protect the privacy of the message. May not be set to 1 unless <i>Auth Flag</i> is also set to 1.																
Auth Flag	1/8 (1 bit)	Authentication Flag: When set to 1, indicates that authentication was used to protect the authenticity of this message.																
Msg Security Model	<i>Integer</i>	4	Message Security Model: An integer value indicating which security model was used for this message. For the user-based security model (the default in SNMPv3) this value is 3.															

Table 222: SNMP Version 3 (SNMPv3) General Message Format (Page 2 of 2)

Field Name	Syntax	Size (bytes)	Description																
Msg Security Parameters	—	Variable	Message Security Parameters: A set of fields that contain parameters required to implement the particular security model used for this message. The contents of this field are specified in each document describing an SNMPv3 security model. For example, the parameters for the user-based model are in RFC 3414.																
Scoped PDU	—	Variable	<p>Scoped PDU: Contains the PDU to be transmitted, along with parameters that identify an SNMP context, which describes a set of management information accessible by a particular entity. The PDU is said to be “scoped” because it is applied within the scope of this context. (Yeah, security stuff is confusing, sorry; it would take pages and pages to properly explain contexts; see RFC 3411.) The field may be encrypted or unencrypted depending on the value of <i>Priv Flag</i> and its structure is:</p> <table border="1"> <thead> <tr> <th>Subfield Name</th> <th>Syntax</th> <th>Size (bytes)</th> <th>Description</th> </tr> </thead> <tbody> <tr> <td>Context Engine ID</td> <td><i>Octet String</i></td> <td>Variable</td> <td>Context Engine ID: Used to identify to which application the PDU will be sent for processing.</td> </tr> <tr> <td>Context Name</td> <td><i>Octet String</i></td> <td>Variable</td> <td>Context Name: An object identifier specifying the particular context associated with this PDU.</td> </tr> <tr> <td>PDU</td> <td>—</td> <td>Variable</td> <td>PDU: The protocol data unit being transmitted.</td> </tr> </tbody> </table>	Subfield Name	Syntax	Size (bytes)	Description	Context Engine ID	<i>Octet String</i>	Variable	Context Engine ID: Used to identify to which application the PDU will be sent for processing.	Context Name	<i>Octet String</i>	Variable	Context Name: An object identifier specifying the particular context associated with this PDU.	PDU	—	Variable	PDU: The protocol data unit being transmitted.
Subfield Name	Syntax	Size (bytes)	Description																
Context Engine ID	<i>Octet String</i>	Variable	Context Engine ID: Used to identify to which application the PDU will be sent for processing.																
Context Name	<i>Octet String</i>	Variable	Context Name: An object identifier specifying the particular context associated with this PDU.																
PDU	—	Variable	PDU: The protocol data unit being transmitted.																

And now, let's look at the PDU format for SNMPv3. Ah ha! We are spared this, because SNMPv3 uses the protocol operations from SNMPv2; this is described in RFC 3416, which is just an update of RFC 1904. Thus, the PDU formats are the same as in [the previous topic](#). Phew!



TCP/IP Remote Network Monitoring (RMON)

The Simple Network Management Protocol (SNMP) defines both a [framework](#) and a [specific protocol](#) for exchanging network information on a TCP/IP internetwork. The [general model used by SNMP](#) is that of a network management station (NMS) that sends requests to SNMP agents running on managed devices. The SNMP agents may also initiate certain types of communication by sending *trap* messages to tell the NMS when particular events occur.

This model works well, which is why SNMP has become so popular. However, one fundamental limitation of the protocol and the model it uses is that it is oriented around the communication of network information from SNMP agents that are normally part of regular TCP/IP devices, such as hosts and routers. The amount of information gathered by these devices is usually somewhat limited, because obviously hosts and routers have “real work to do”—that is, doing the jobs of being hosts and routers. They can't devote themselves to network management tasks.

Thus, in situations where more information is needed about a network than is gathered by traditional devices, administrators often use special hardware units called *network analyzers, monitors* or *probes*. These are dedicated pieces of equipment that are connected to a network and used strictly for the purpose of gathering statistics and watching for events of interest or concern to the administrator. It would obviously be very useful if these devices could use SNMP to allow the information they gather to be retrieved, and to let them generate traps when they notice something important.

To enable this, the *Remote Network Monitoring (RMON)* specification was created. RMON is often called a protocol, and you will sometimes see SNMP and RMON referred to as “the TCP/IP network management protocols”. However, RMON really isn't a separate protocol at all—it defines no protocol operations. RMON is in fact part of SNMP, and the RMON specification is simply a [management information base \(MIB\) module](#) that defines a particular set of MIB objects for use by network monitoring probes. Architecturally, it is just one of the many MIB modules that comprise the SNMP Framework.



Key Concept: SNMP *Remote Network Monitoring (RMON)* was created to enable the efficient management of networks using dedicated management devices such as network analyzers, monitors or probes. RMON is often called a “protocol”, but does not in fact define any new protocol operations; it is a MIB module for SNMP that describes objects that permit advanced network management capabilities.

RMON Standards

The first standard documenting RMON was RFC 1271, *Remote Network Monitoring Management Information Base*, published in 1991. RFC 1271 was replaced by RFC 1757 in 1995, which made a couple of changes to the specification. RFC 2819, May 2000, updates RMON to use the new [Structure of Management Information version 2 \(SMIv2\)](#) specification that is part of SNMPv2 but is functionally the same as RFC 1757.

RMON MIB Hierarchy and Object Groups

Since RMON is a MIB module, it consists almost entirely of descriptions for MIB objects, with each having the standard characteristics belonging to all such objects. All the objects within RMON are arranged into the SNMP object name hierarchy within the *rmon* group, which is group number 16 within the SNMP *mib (mib-2)* object tree, 1.3.6.1.2.1. So, all RMON objects have identifiers starting with 1.3.6.1.2.1.16. This single RMON group is broken down into several lower-level groups that provide more structure for the RMON objects defined by the specification. [Figure 286](#) shows this structure.

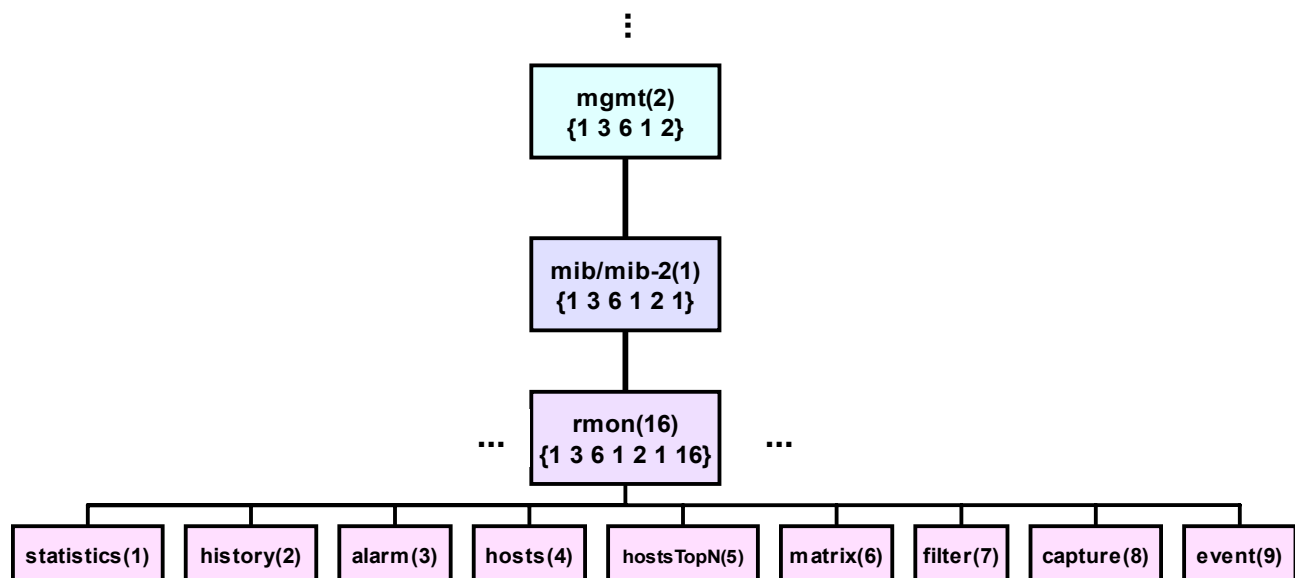

Figure 286: SNMP Remote Network Monitoring (RMON) MIB Hierarchy

RMON uses a special MIB module, *rmon(16)*, which fits into the overall SNMP object hierarchy tree under *mib/mib-2(1)* within *mgmt(2)*—just like other MIB object groups such as *sys(1)* and *if(2)*; see [Figure 273](#).

Within this group, which has the group identifier 1.3.6.1.2.1.16, are 9 subgroups of RMON objects.

Table 223 describes each of the RMON groups, showing for each its name, its group code (which is used as the prefix for [object descriptors](#) in the group), and its RMON group number and SNMP object hierarchy identifier:

Table 223: SNMP RMON MIB Object Groups (Page 1 of 2)

RMON Group Name	RMON Group Code	RMON Group Number	Full Group Identifier	Description
<i>statistics</i>	<i>etherStats</i>	1	1.3.6.1.2.1.16.1	Objects that keep track of network statistics measured by the device. Example statistics include network traffic load, average packet size, number of broadcasts observed, counts of errors that have occurred, the number of packets in various size ranges and so forth.
<i>history</i>	<i>history, ether-History</i>	2	1.3.6.1.2.1.16.2	The history group contains a single table object that controls how often statistical data is sampled by the probe. The additional <i>ether-History</i> group is optional and contains extra Ethernet-specific information; it is contained logically within the <i>history</i> group.
<i>alarm</i>	<i>alarm</i>	3	1.3.6.1.2.1.16.3	This group defines the parameters under which an alarm may be generated to inform an administrator of an occurrence of import. The <i>alarm</i> group contains a table that describes the thresholds that will cause an event to be triggered (see the <i>event</i> group below).
<i>hosts</i>	<i>host</i>	4	1.3.6.1.2.1.16.4	Contains objects that keep track of information for each host on a network.
<i>hostsTopN</i>	<i>hostTopN</i>	5	1.3.6.1.2.1.16.5	This group contains objects that facilitate reporting of hosts sorted in a particular way. The administrator determines how these ordered statistics are tracked. For example, an administrator could generate a report listing hosts sorted by the number of packets transmitted, showing the most active devices.
<i>matrix</i>	<i>matrix</i>	6	1.3.6.1.2.1.16.6	This group keeps track of statistics for data exchanges between particular pairs of hosts. So, the amount of data sent between any two devices on the network could be tracked here. Since a large network could have thousands of such device pairs, to conserve resources on the probe, often only the most recent “conversations” between device pairs are kept in the management information base.
<i>filter</i>	<i>filter</i>	7	1.3.6.1.2.1.16.7	This RMON group allows an administrator to set up filters that control what sorts of network packets the probe will capture.

Table 223: SNMP RMON MIB Object Groups (Page 2 of 2)

RMON Group Name	RMON Group Code	RMON Group Number	Full Group Identifier	Description
<i>capture</i>	<i>buffer, capture</i>	8	1.3.6.1.2.1.16.8	This group is used to allow a probe to capture packets based on particular parameters set up in the filter group.
<i>event</i>	<i>event</i>	9	1.3.6.1.2.1.16.9	When a particular alarm is triggered based on the parameters in the objects in the <i>alarm</i> group, an event is generated. This group controls how these events are processed, including creating and sending an SNMP trap message to a network monitoring station.

The original RMON standard was heavily oriented around Ethernet LANs, and you can see some of that in the table above. Probes can also gather and report information related to other networking technologies, by using other RMON groups created for that purpose. The best example of this was the definition of a set of groups specifically for Token Ring, which was defined in RFC 1513 in 1993.

RMON Alarms, Events and Statistics

Alarms and events are particularly useful constructs in RMON, as they allow the immediate communication of important information to a network management station. The administrator has full control over what conditions will cause an alarm to be “sounded” and how an event is generated. This includes specifying what variables or statistics to monitor, how often to check them, and what values will trigger an alarm. A log entry may also be recorded when an event occurs. If an event results in transmission of a trap message, the administrator will thus be notified and can decide how to respond, depending on the severity of the event.

Like all MIB modules and groups, a particular manufacturer may decide which RMON groups to implement. However, certain groups are related, such as *alarm* and *event*, and some groups such as *statistics* are pretty much always implemented in all RMON probes. Obviously, when RMON is used, the network management station must be aware of RMON groups and must allow a network management application to be run that will exploit the capabilities of the RMON MIB objects.



TCP/IP Key Applications and Application Protocols

For centuries, philosophers have struggled with this question: “what's it all about?” Needless to say, the meaning of life is a bit beyond the scope of this Guide. ☺ However, we **can** examine this quandary within the scope of networking itself. What is networking for? Why do we bother creating networks anyway? What's it all about?

The simplified answer is that all of the hardware devices, software modules and layered protocols examined in this Guide are means to one real end: enabling people to use networking *applications*. The true **power of layering** is that it allows applications to be created that automatically make use of lower-level technologies to communicate without having to worry about the details of how the communication is accomplished. This frees application programmers to create a wide variety of applications that find many different ways to facilitate the exchange information.

The **TCP/IP protocol suite** is the foundation of modern internetworking, and for this reason, has been used as the primary platform for the development and implementation of networking applications. Over the last few decade, as the global TCP/IP Internet has grown, hundreds of new applications have been created. These programs enable a myriad of different tasks and functions to be accomplished, ranging from implementing essential business tasks to pure entertainment, by users who may be in the same room or on different continents.

It would be impossible to try to describe every possible TCP/IP application, and pointless to even try. However, of all the TCP/IP applications, there are a small number that are widely considered to be “key applications” of TCP/IP. Most have been around for a very long time—in some cases, longer than even the modern Internet Protocol itself. They are generally implemented as TCP/IP *application protocols* and are defined using the same **RFC process and standards** as other TCP/IP protocol suite components.

This section describes some of these definitive TCP/IP applications and application layer protocols. Before getting into the applications themselves, I explain the universal system set up for TCP/IP applications to use for addressing Internet resources: uniform resource identifiers (URIs), which can be either uniform resource locators (URLs) or uniform resource names (URNs). These are best known for their use on the World Wide Web, but can in fact be used by a variety of applications.

I then provide several subsections that discuss the application groups themselves. The first describes file and message transfer applications; this group is the largest, as it contains many of the applications we consider central to TCP/IP networking, such as electronic mail, file transfer and the World Wide Web. The second describes interactive and remote application protocols, which are used traditionally to allow a user of one computer to access another, or to permit the real-time exchange of information. The third discusses TCP/IP administration and troubleshooting utilities, which can be employed by both administrators and end users alike.

TCP/IP Application Layer Addressing: Uniform Resource Identifiers, Locators and Names (URIs, URLs and URNs)

The Internet consists of millions of interconnected servers, each of which is capable of providing useful information to Internet users who request it. The more information a network has, the richer it is, but the more difficult it becomes to locate. In order to use information, we need to be able to find it, and that requires at a minimum that we employ some means for labeling each file or object.

For this purpose, TCP/IP has defined a system of *Uniform Resource Identifiers (URIs)* that can be used both on the Internet and on private TCP/IP networks. Each URI uniquely specifies how a client can locate a particular resource and access it so it can be used. URIs are subdivided into *Uniform Resource Locators (URLs)* and *Uniform Resource Names (URNs)*, which serve a similar purpose but work in different ways.

In this section I describe the system of addressing used on the Internet to identify files, objects and resources. I begin with an overview, which introduces the concept of Uniform Resource Identifiers (URIs), and explains the differences between URIs, URLs and URNs. At the present time, URLs are used much more often than URNs. Therefore, I have included a full subsection with several topics that cover in detail the syntax of URLs, as well as important issues related to how they are used. I also have a summary topic that gives a summary overview of URNs and their role in Internet addressing.

Uniform Resource Identifiers, Locators and Names (URIs, URLs and URNs): Overview, History, Significance and Standards

If you've been “working your way up” the [OSI Reference Model layers](#) in reading this Guide, you might well have expected that you'd be done with addressing by this point. After all, we have already discussed [MAC addresses at layer two](#) and [IP addresses at layer three](#), and [mechanisms for converting between them](#). We even have [ports and sockets that provide transport layer addressing capabilities](#) to let each device run multiple software applications. Given all this, the idea of “application layer addressing” may seem a bit strange, and I am aware that using the term to refer to the subject of this section may be a bit unorthodox.

The Rationale for Application Layer Addressing

The concept of addressing for applications isn't really as odd as it might seem at first, however. It's true that with an IP address and a port number we can theoretically access any resource on a TCP/IP internet—the problem is *finding it*. Application layer addressing is not something that is required by the computer software; it is something that makes it easier for humans to identify and locate resources.

This is in fact very much the same rationale that is used to justify the creation of [name systems](#), such as the [Domain Name System \(DNS\)](#). DNS is a form of high-level addressing that allows names to be used instead of IP addresses. It too is important not so much for computers but rather for people, who understand what “www.intel.com” means much more than “198.175.96.33”.

The idea behind a comprehensive application layer addressing scheme is to extend to the next level what DNS has already accomplished. DNS names provide essential high-level abstract addressing, but only of whole devices (whether real or virtual). These names can be used as the basis for a more complete labeling scheme that points not just to a site or device, but to a specific file, object or other resource. In TCP/IP, these labels are called *Uniform Resource Identifiers (URIs)*.

URIs were one of the key technologies developed as part of the [World Wide Web \(WWW\)](#), and are still most often associated with WWW and the protocol that implements it, [HTTP](#). You have likely used URIs thousands of times in the past; whenever you have entered something like “http://www.myfavoritewebsite.com” into a Web browser, you were using a URI. (URI? Isn't that a URL? I'm getting there, I promise.)

The reason why URIs are so important to the Web is that they combine into one string all of the information necessary to refer to a resource. This *compactness of expression* is essential to the entire concept of hypertext resource linking. If we want to be able to have an object in one document point to another, we need to have a simple way of describing that object without requiring a whole set of instructions. URIs allow us to do exactly that.

In fact, URIs are so associated with the Web that they are usually described as being part of Web technology specifically. They are not, however, unique to the Web, which is why this section is separate from that discussing WWW/HTTP.

URI Categories

URIs are in fact a general purpose method for referring to many kinds of TCP/IP resources. They are currently divided into two primary categories based on how they describe a resource:

- ① **Uniform Resource Locators (URLs):** A [URL](#) is a uniform resource identifier that refers to a resource through the combination of a protocol or access mechanism and a specific resource location. A URL begins with the name of the protocol to be used for accessing the resource and then contains sufficient information to point to how it can be obtained.
- ② **Uniform Resource Names (URNs):** A [URN](#) is a uniform resource identifier that provides a way of uniquely naming a resource without specifying an access protocol or mechanism, and without specifying a particular location.

The difference between a URL and a URN is that the former is much more specific and oriented around *how* to access a resource, while the latter is more abstract and designed more to identify *what* the resource is than describe how to get it. Giving someone a URL is like giving them directions to find a book, as follows: “Take the train to Albuquerque, then Bus #11 to 41 Albert Street, a red brick house owned by Joanne Johnson. The book you want is the third from the right on the bottom of the bookshelf on the second floor”. A URN is more like referring to a book using its International Standard Book Number (ISBN); it uniquely identifies the book regardless of where the book may be located, and doesn't tell you how to access it. (In fact, ISBNs are one of the identification systems used with URNs.)

While URLs and URNs are theoretical peers, in practice, URLs are used far more than URNs. In fact, URLs are so dominant that most people have never even *heard of* URIs or URNs. The reason is that even though the example above suggests that URNs are more “natural” than URLs, URLs are easier to use in practice—they provide the information needed to access a resource, and without being able to access a resource, simply knowing how to identify it is of limited value. URNs are an attractive concept because they identify a resource without tying it to a specific access mechanism or location. However, the implementation of URNs requires some means of tying the permanent identifier of a resource to where it is at any given moment, which is not a simple task. For this reason, URNs and the methods for using them have been in development for a number of years, while URLs have been in active use all that time.

While URLs began with the Web and most URLs are still used with HTTP, they can and do refer to resources that are accessed using many other protocols, such as [FTP](#) and [Telnet](#). Again here, the compactness of URIs makes them very powerful; with a URL, we can use one string to tell a program to retrieve a file using FTP. This replaces the [complete FTP process](#) of starting an FTP client, establishing a session, logging in and issuing commands.



Key Concept: Some sort of mechanism is needed on any internetwork to allow resources such as files, directories and programs to be identified and accessed. In TCP/IP, *Uniform Resource Identifiers (URIs)* are used for this sort of “application layer addressing”. The two types of URIs are *Uniform Resource Locators (URLs)*, which specify how to access an object using a combination of an access method and location, and *Uniform Resource Names (URNs)*, which identify an object by name but do not indicate how to access it.

URI Standards

A number of Internet standards published in the 1990s describe the syntax and basic use of URIs, URLs and URNs. The first was RFC 1630, *Universal Resource Identifiers in WWW*, which was published in 1994 and is still a good overview of the topic. In December 1994 a pair of documents, RFCs 1737 and 1738, provided more specific information about URNs and URLs respectively. RFC 1808 describes how to define and use [relative URLs](#), while RFC 2141 provides more information on URN syntax.

RFC 2396, *Uniform Resource Identifiers (URI): Generic Syntax*, was published in August 1998 to revise and replace some of the information in many of the previous RFCs just mentioned. It is probably the definitive standard on URIs at the present time, though RFCs continue to be published discussing issues related to URIs. This is especially true of URNs, which as I said before, are still in active development.

The base documents such as RFC 2396 describe how URLs can be specified for a number of common protocols (called *schemes* in URL-speak, as we will see when we look at URLs more closely). To provide flexibility, a mechanism was also defined to allow new URL schemes to be registered. This is described in RFC 2717, *Registration Procedures for URL Scheme Names*, and RFC 2718, *Guidelines for new URL Schemes*. There are also a few RFCs that describe specific URL schemes for different protocols, including RFCs 2192 ([IMAP](#)), 2224 ([NFS](#)), 2368 ([e-mail](#)) and 2384 ([POP](#)).



Uniform Resource Locators (URLs)

Uniform Resource Locators (URLs) are text strings that allow a resource such as a file or other object to be labelled based on its location on an internet network and the primary method or protocol by which it may be accessed. URLs have become the most common type of [Uniform Resource Identifier \(URI\)](#) used for application layer addressing in TCP/IP because of their simplicity.

In this section I provide a detailed explanation of Uniform Resource Locators and how they are used. I begin with an overview of the general syntax used for standard URLs, sometimes called “absolute” URLs to distinguish them from relative URLs. I then provide a description of the URL schemes used for the most common applications and access methods, and the specific syntax used by each. I then discuss how relative URLs work and why they are important. Finally, I discuss some of the real world issues associated with using URLs; this includes problems related to long and complex URLs, as well as the intentional obfuscation “games” being played by some unscrupulous people.



Background Information: Please be sure you have read [the overview topic on URIs, URLs and URNs](#) before reading this section, as that topic contains an essential overall introduction to what URLs are.

URL General Syntax

Uniform Resource Locators (URLs) are a subset of [Uniform Resource Identifiers \(URIs\)](#) that consist of two components that identify how to access a resource on a TCP/IP inter-network. These two components are the *location* of the resource, and the *method* to be used to access it. These two pieces of information, taken together, allow a user with the appropriate software to obtain, read or otherwise work with many different kinds of resources such as files, objects, programs and much more.

The most general form of syntax for a URL contains only two elements, which correspond to the two pieces of information just described:

`<scheme>:<scheme-specific-part>`

The term *scheme* refers to a type of access method, which describes the way that the resource is to be used; it usually refers to either an application protocol, such as “http” or “ftp”, or a resource type such as “file”. A scheme name must contain only letters, plus signs (“+”), periods (“.”) and hyphens (“-”). In practice, they usually contain only letters. Schemes are case-insensitive but usually expressed in lower case.

The rest of the URL after the scheme (and the required colon separator) is scheme-specific. This is necessary because various protocols and access methods require different types and quantities of information to identify a particular resource. When a URL is read, the scheme name tells the program parsing it how to interpret the syntax of the rest of the URL.



Key Concept: *Uniform Resource Locators (URLs)* are the most widely-used type of URI. In its most basic form, a URL consists of two elements: a *scheme* that defines the protocol or other mechanism for accessing the resource, and a *scheme-specific part* that contains information that identifies the specific resource and indicates how it should be used. Some schemes use a common syntax for their scheme-specific parts, while others use a syntax unique to the scheme.

Common Internet Scheme Syntax

In theory, each scheme may use a completely different syntax entirely for the “<scheme-specific-part>”. However, many of these schemes share a common syntax for this part, by virtue of the similarities in how they refer to internetwork devices and resources on those devices. For example, both HTTP and FTP are used to point to specific TCP/IP devices using a DNS name or IP address, and then access resources stored in a hierarchical directory structure. It makes sense that their URLs would be at least somewhat similar.

The most general form of this common Internet scheme syntax is as follows:

```
<scheme>://<user>:<password>@<host>:<port>/<url-path>;<params>?<query>#<fragment>
```

The elements of this syntax are as follows:

- ① **<scheme>**: The URL scheme, as described above.
- ② **<user> and <password>**: Authentication information for schemes requiring a login, in the form of a user name and password.
- ③ **<host>**: An Internet host, usually specified either as a [fully qualified DNS domain name](#), or an IP address in dotted-decimal notation.
- ④ **<port>**: A [TCP or UDP port number](#) to use when invoking the protocol appropriate to the scheme.
- ⑤ **<url-path>**: A resource location path. This is usually a full directory path expressing the sequence of directories to be traversed from the root directory to the place where the resource is located, and then the resource's name. For example, if on a device there is a directory called “project1” and within it a subdirectory called “memos” containing a text file called “June11th-minutes.txt”, the URL path “project1/memos/June11th-minutes.txt” would refer to that resource.

Note that the slash before the <url-path> is required, and while it is technically not considered part of the path, it serves the purpose of “acting” like the slash denoting the root directory in many file systems. Also, the <url-path> may end in a slash, which means that the path refers specifically to a directory. However, this is often not required, as the server will treat the URL as a directory reference by context when needed. A path may also refer to a virtual file, program or resource other than a “normal” file.

- ☉ **<params>**: Scheme-specific parameters included to control how the scheme is used to access the resource. Each parameter is generally of the form “<parameter>=<value>”, with each parameter specification separated from the next using a semi-colon.
- ☉ **<query>**: An optional query or other information to be passed to the server when the resource is accessed.
- ☉ **<fragment>**: Identifies a particular place within a resource that the user of the URL is interested in.

Figure 287 illustrates this common syntax and its elements using an example HTTP URL.

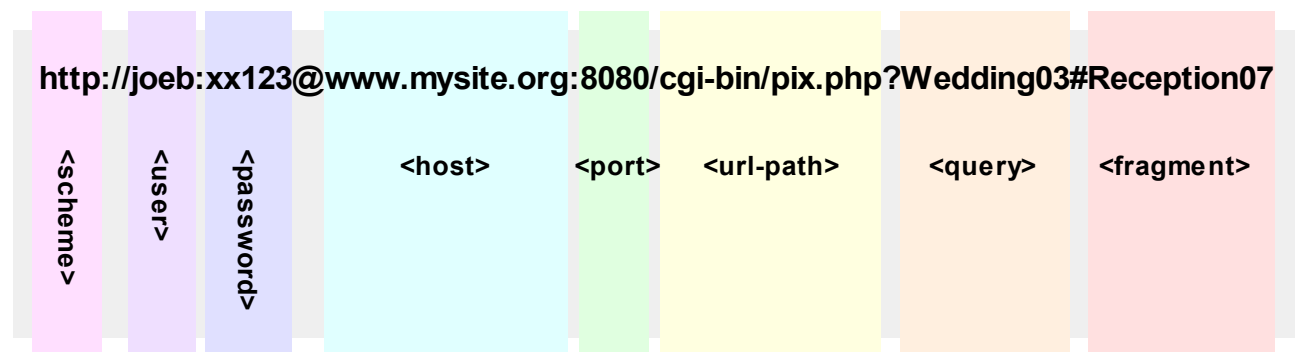

Figure 287: Example Uniform Resource Locator (URL)

This diagram shows a sample URL that includes almost all of the possible elements in the general scheme syntax, each of them highlighted using snazzy rainbow-colored boxes. ☉ This URL identifies a Web (HTTP) resource that must be accessed using a particular password at the site “www.mysite.org” using port 8080. The resource in this case is a PHP program in the site’s “cgi-bin” directory that causes a particular page of photographs to be displayed. The “<fragment>” specifier will cause the picture “Reception07” on the retrieved page of wedding photos to be displayed to the user.

Omission of URL Syntax Elements

The full URL syntax may seem very complicated, but bear in mind that this is a formal definition and shows all of the possible elements in a URL at once. Most schemes do not use every one of these elements, and furthermore, many of them are optional even when they are valid in a particular scheme. For example, the `<login>` and `<password>` are officially supported for HTTP URLs, but are very rarely used. Similarly, port numbers are most often omitted, telling the client software to just use the default port number for the scheme. [The next topic](#) describes some of the most common URL schemes and the specific syntaxes used for them, including discussing how and when these elements are employed.

Even though the richness of the URL syntax isn't often needed, it can be useful for supplying a wide variety of information in special cases. URLs are also very flexible in terms of how they may be expressed. For example, while a “<host>” is usually a DNS name, it can also be an IP address expressed in many forms including dotted-decimal, regular decimal, hexadecimal, octal and even a combination of these. Unfortunately, the lack of familiarity

that most people have with some of these “esoterics” has led to [URLs being abused through deliberate obscurity](#), to get people to visit “resources” they would normally want to avoid.

URL Fragments

Technically, a “<fragment>” is not considered a formal part of the URL by the standards that describe resource naming. The reason is that it only identifies a portion of a resource, and is not part of the information required to identify the resource itself. It is not sent to the server but retained by the client software, to guide it in how to display or use the resource. Some would make a valid argument, however, that this distinction is somewhat arbitrary; consider, for example, that the scheme itself is also used only by the client, as is the host itself.

The most common example of a URL fragment is specifying a particular bookmark to “scroll” to in displaying a Web page. In practice, a fragment identifier is often treated **as if** it were part of a URL since it is part of the string that specifies a URL.

“Unsafe” Characters and Special Encodings

URLs are normally expressed in the standard US ASCII character set, which is the default used by most TCP/IP application protocols. Certain characters in the set are called *unsafe*, because they have special meaning in different contexts, and including them in a URL would lead to ambiguity or problems in of how they should be interpreted. The “space” character is the classical “unsafe” character because spaces are normally used to separate URLs, so including one in a URL would break the URL into “pieces”. Other characters are “unsafe” because they have special significance in a URL, such as the colon (“:”).

The “safe” characters in a URL are alphanumeric (A to Z, a to z and 0 to 9) and the following special characters: the dollar sign (“\$”), hyphen (“-”), underscore (“_”), period (“.”), plus sign (“+”), exclamation point (“!”), asterisk (“*”), apostrophe (“’”), left parenthesis (“(”), and right parenthesis (“)”). All other “unsafe” characters can be represented in a URL using an encoding scheme consisting of a percent sign (“%”) followed by the hexadecimal ASCII value of the character. The most common examples are given in [Table 224](#).

Table 224: URL Special Character Encodings

Character	Encoding	Character	Encoding	Character	Encoding
<space>	%20	<	%3C	>	%3E
#	%23	%	%25	{	%7B
}	%7D		%7C	\	%5C
^	%5E	~	%7E	[%5B
]	%5D	`	%60	;	%3B
/	%2F	?	%3F	:	%3A
@	%40	=	%3D	%	%26

When these sequences are encountered, they are interpreted as the literal character they represent, without any “significance”. So, the URL “http://www.myfavesite.com/are%20you%20there%3F” points to a file called “are you there?” on “www.myfavesite.com”. The “%20” codes prevent the spaces from breaking up the URL, and the “3F” prevents the question mark in the file name from being interpreted as a special URL character.



Note: Since the percent sign is used for this encoding mechanism, it itself is “special”; any time it is seen the next values are interpreted as character encodings, so to embed a literal percent sign, it must be encoded as “%25”.

Again, these encodings are sometimes abused for nefarious purposes, unfortunately, such as using them for regular ASCII characters to [obscure URLs](#).

URL Schemes (Applications / Access Methods) and Scheme-Specific Syntaxes

Uniform Resource Locators (URLs) use a general syntax that describes the location and method for accessing a TCP/IP resource. Each access method, called a *scheme*, has its own specific URL syntax, including the various pieces of information required by the method to identify a resource. RFC 1738 includes a description of the specific syntaxes used by several popular URL schemes. Others have been defined in subsequent RFCs using the procedure established for URL scheme registration.

Several of the URL schemes use the common Internet pattern given in my [overview of URL syntax](#). Other schemes use entirely different (usually simpler) structures based on their needs. For reference, I will repeat the general syntax again here, as it will help you understand the rest of the topic:

```
<scheme>://<user>:<password>@<host>:<port>/<url-path>;<params>?<query>#<fragment>
```

The following are the most common URL schemes and the scheme-specific syntaxes they use.

World Wide Web / Hypertext Transfer Protocol URL Syntax (http)

[The Web](#) potentially uses most of the elements of the common Internet scheme syntax, as follows:

```
http://<user>:<password>@<host>:<port>/<url-path>?<query>#<bookmark>
```

As discussed in the overview, the Web is the primary application using URLs today. A URL can theoretically contain most of the common URL syntax elements, but in practice most are omitted. Most URLs contain only a host and a path to a resource. The port number is usually omitted, implying that the default value of 80 should be used. The “<query>” construct is often used to pass arguments or information from the client to the Web server.

I have provided full details on how Web URLs are used in [a separate topic in the section on HTTP](#).

File Transfer Protocol URL Syntax (ftp)

The syntax for FTP URLs is:

```
ftp://<user>:<password>@<host>:<port>/<url-path>;type=<typecode>
```

FTP is an interactive command-based protocol, so it may seem odd to use a URL for FTP. However, one of the most common uses of FTP is to access and read a single, particular file, and this is what an FTP URL allows a client to do. The `<user>` and `<password>` are used for login and may be omitted for [anonymous FTP access](#). The port number is usually omitted and defaults to the standard FTP control channel port, 21.

The “`<url-path>`” is interpreted as a directory structure and file name. The appropriate “CWD” (“change working directory”) [commands](#) are issued to go to the specified directory, and then a “RETR” (“retrieve”) command is issued for the named file. The optional “type” parameter can be used to indicate the [file type](#): “a” to specify an ASCII file retrieval or “i” for an image (binary) file. The “type” parameter is often omitted from the URL, with the correct mode being set automatically by the client based on the name of the file.

For example, consider this URL:

```
ftp://ftp.hardwarecompanyx.com/drivers/widgetdriver.zip
```

This is equivalent to starting an FTP client, making an anonymous FTP connection to “ftp.hardwarecompanyx.com”, then changing to the “drivers” directory and retrieving the file “widgetdriver.zip”. The client will retrieve the file in binary mode because it is a compressed “zip” file.

It is also possible to use an FTP URL to get a listing of the files within a particular directory. This allows a user to navigate an FTP server’s directory structure using URL links to find the file he or she wants, and then retrieve it. This is done by specifying a directory name for the `<url-path>` and using the “type” parameter with a “`<typecode>`” of “d” to request a directory listing. Again, the “type” parameter is usually omitted and the software figures out to send a “LIST” command to the server when a directory name is given in a URL.

URL Syntax for Sending Electronic Mail (mailto)

A special syntax is defined to allow a URL to represent the command to send mail to a user:

```
mailto:<e-mail-address>
```

The [e-mail address](#) is in standard Internet form: “`<username>@<domainname>`”. This is really an unusual type of URL because it does not really represent an object at all, though a person can be considered a type of “resource”.



Note: Note that optional parameters, such as the subject of the e-mail, can also be included in a *mailto* URL. This facility is not often used, however.

Gopher Protocol URL Syntax (gopher)

The syntax for the Gopher Protocol is similar to that of HTTP and FTP:

```
gopher://<host>:<port>/<gopher-path>
```

See the [topic on the Gopher protocol](#) for more information on Gopher paths and how the protocol operates.

Network News / Usenet URL Syntaxes (news)

Two syntaxes are defined for URL specification of Usenet (NetNews):

```
news://<newsgroup-name>  
news://<message-id>
```

Both of these URLs are used to access a [Usenet newsgroup](#) or a specific message, referenced by message ID. Like the “mailto” scheme, this is a special type of URL because it defines an access method but does not provide the detailed information to describe how to locate a newsgroup or message.

By definition, the first form of this URL is interpreted as being “local”. So for example, “news://alt.food.sushi” means “access the newsgroup *alt.food.sushi* on the local news server, using the default news protocol”. The default news protocol is normally NNTP (see below). The second URL form is global, because message IDs are unique on Usenet (or at least, are supposed to be!)

Network News Transfer Protocol URL Syntax (nntp)

This is a different URL type for news access:

```
nntp://<host>:<port>/<newsgroup-name>/<article-number>
```

Unlike “news”, this URL form specifically requests the use of [NNTP](#) and identifies a particular NNTP server. Then it tells the server which newsgroup to access and which article number within that newsgroup. Note that articles are numbered using a different sequence by each server, so this is still a “local” form of news addressing. The port number defaults to 119.

Even though the “nntp” form seems to provide a more complete resource specification, the “news” URL is more often used, because it is simpler. It's easier just to set up the appropriate NNTP server in the client software once than to specify it each time, since clients usually only use one NNTP server.

Telnet URL Syntax (*telnet*)

This scheme is used to open a [Telnet](#) connection to a server. This is the syntax:

```
telnet://<user>:<password>@<host>:<port>
```

In practice, the user name and password are often omitted, which causes the Telnet server to prompt for this information. Alternately, the “<user>” can be supplied and the password left out (to prevent it being seen) and the server will prompt for just the password. The port number defaults to the standard port for Telnet, 23, and is also often omitted.

This type of URL is interesting in that it identifies a resource that is not an object but rather a *service*.

Local File URL Syntax (*file*)

This is a special URL type used for referring to files on a particular host computer. The standard syntax is:

```
file://<host>:<url-path>
```

This type of URL is also somewhat interesting, in that it describes the location of an object but not an access method. It is not sufficiently general to allow access to a file anywhere on an internetwork, but is often used for referencing files on computers on a local area network where names have been assigned to different devices.

A special syntax is also defined to refer specifically to files on the local computer:

```
file:///<url-path>
```

Here, the entire “//<host>:” element has been replaced by a set of three slashes, meaning specifically, “look on the local host”.

Additional URL Syntax Rules

Additional syntax rules are often used by browsers to support the quirks of Microsoft operating systems, especially for the “file” scheme. First, the backslashes used by Microsoft Windows are expressed as forward slashes as required by TCP/IP. Second, since colons are used in drive letters specifications in Microsoft operating systems, these are replaced by the “vertical pipe” character, “|”, which “sorta looks like a colon” (play along, please. ☺)

So, to refer to the file “C:\WINDOWS\SYSTEM32\DRIVERS\ETC\HOSTS”, the following URL could be used:

`file:///C:/WINDOWS/SYSTEM32/DRIVERS/ETC/HOSTS`

Note however that some browsers actually **do** allow the colon in the drive specification.

URL Relative Syntax and Base URLs

The Uniform Resource Locator syntax described in [the first topic of this section](#) is sometimes said to specify an *absolute* URL. This is because the information in the URL is sufficient to completely identify the resource. Absolute URLs thus have the property of being *context-independent*, meaning that one can access and retrieve the resource using the URL without any additional information required.

Since the entire point of a URL is to provide the information needed to locate and access a resource, it makes sense that we would want them to be absolute in definition most of the time. The problem with absolute URLs is that they can be long and cumbersome. There are cases where many different resources need to be identified that have a relationship to each other; the URLs for these resources often have many common elements. Using absolute URLs in such situations leads to a lot of excess and redundant “verbiage”.

The Motivation for Relative URLs

In my [overview of URIs](#) I gave a “real world” analogy to a URL in the form of a description of an “access method” and location for a person retrieving a book: “Take the train to Albuquerque, then Bus #11 to 41 Albert Street, a red brick house owned by Joanne Johnson. The book you want is the third from the right on the bottom of the bookshelf on the second floor”.

What if I also wanted the same person to get a second book located in the same house on the ground floor after getting the first one? Should I start by saying again “take the train to Albuquerque, then Bus #11 to 41 Albert Street, a red brick house owned by Joanne Johnson”? Why bother, when they are already there at that house? No, I would give a second instruction in **relative** terms: “go back downstairs, and also get the blue book on the wood table”. This instruction only makes sense in the context of the original one.

The same need arises in URLs. Consider a Web page located at “http://www.longdomain-namesareirritating.com/index.htm” that has 37 embedded graphic images in it. The poor guy stuck with maintaining this site doesn’t want to have to put “http://www.longdomain-namesareirritating.com/” in front of the URL of every image.

Similarly, if we have just taken a directory listing at “ftp://ftp.somesitesomewhere.org/very/deep/directory/structures/also/stink/” and we want to explore the parent directory, we would like to just say “go up one level” without having to say “ftp://ftp.somesitesomewhere.org/very/deep/directory/structures/also/”.

Creating and Interpreting Relative URLs

It is for these reasons that URL syntax was extended to include a *relative* form. In simplest terms, a relative URL is the same as an absolute URL but with pieces of information omitted that are implied by context. Like our “go downstairs” instruction, a relative URL does not by itself contain enough information to specify a resource. A relative URL **must** be interpreted within a context that provides the missing information.

The context needed to find a resource from a relative URL is provided in the form of a *base URL* that provides the missing information. A base URL must be either a specific absolute URL, or itself a relative URL that refers to some other absolute base. The base URL may be either explicitly stated or may be inferred from use. The RFCs dealing with URLs define three methods for determining the base URL, which are arranged into the following precedence:

1. **Base URL Within Document:** Some documents allow the base URL to be explicitly stated. If present, this specification is used for any relative URLs in the document.
2. **Base URL From Encapsulating Entity:** In cases where no explicit base URL is specified in a document, but the document is part of a higher-level entity enclosing it, the base URL is the URL of the “parent” document. For example, a document within a body part of a [MIME multipart message](#) can use the URL of the message as a whole as the base URL for relative references.
3. **Base URL From Retrieval URL:** If neither of those two methods are feasible, the base URL is inferred from the URL used to retrieve the document containing the relative URL.

Of these three methods, #1 and #3 are the most common. [HTML](#), the language used for the Web, allows a base URL to be explicitly stated which removes any doubt about how relative URLs are to be interpreted. Failing this, method #3 is commonly used for images and other links in HTML documents that are specified in relative terms.

For example, let's go back to the poor slob maintaining “<http://www.longdomainnamesareirritating.com/index.htm>”. By default, any images referenced from that “index.htm” HTML document can use relative URLs—the base URL will be assumed from the name of the document itself. So he can just say “companylogo.gif” instead of “<http://www.longdomainnamesareirritating.com/companylogo.gif>”, as long as that file is in the same directory on the same server as “index.htm”.

If all three of these methods fail for whatever reason, then no base URL can be determined. Relative URLs in such a document will be interpreted as absolute URLs, and since they do not contain complete information, they will not work properly.

Also, relative URLs only have meaning for certain URL schemes. For others, they make no sense and cannot be used. In particular, relative URLs are never used for the “telnet”, “mailto” and “news” schemes. They are very commonly used for HTTP documents, and may also be used for FTP and file URLs.



Key Concept: Regular URLs are *absolute*, meaning that they include all of the information needed to fully specify how to access a resource. In situations where many resources need to be accessed that are approximately in the same place or are related in some way, completely specifying a URL can be inefficient. Instead, *relative* URLs can be used, which specify how to access a resource relative to the location of another one. A relative URL can only be interpreted within the context of a base URL that provides any information missing from the relative reference.

Practical Interpretation of Relative URLs

The description above probably seems confusing, but relative URLs are actually fairly easy to understand, because they are interpreted in a rather “common sense” way. You simply take the base URL and the relative URL, and you substitute whatever information is in the relative URL for the appropriate information in the base URL to get the resulting equivalent absolute reference. In so doing, you must “drop” any elements that are more specific than the ones being replaced.

What do I mean by “more specific”? Well, most URLs can be considered to move from “most general” to “most specific” in terms of the location they specify. As you go from left to right, you go through the host name, then high-level directories, subdirectories, the file name, and optionally, parameters/query/fragment applied to the file name. If a relative URL specifies a new file name, it replaces the file name in the base URL, and any parameters/query/fragment are dropped as they no longer have meaning given that the file name has changed. If the relative URL changes the host name, the entire directory structure, file name and everything else “to the right” of the host name “goes away”, replaced with any that might have been included in the new host name specification.

This is hard to explain in words but easy to understand with a few examples. Let's assume we start with the following explicit base URL:

`http://site.net/dir1/subdir1/file1?query1#bookmark1`

Table 225 shows some example of relative URLs and how they would be interpreted.

Table 225: Relative URL Specifications and Absolute Equivalents

Relative URL	Equivalent Absolute URL	Explanation
#bookmark2	http://site.net/dir1/subdir1/file1?query1#bookmark2	The URL is the same except that the bookmark is different. This can be used to reference different places in the same document in HTML. (Technically, the URL has not changed here, since the “fragment” (bookmark) is not part of the actual URL. A Web browser given a new bookmark name will usually not try to re-access the resource.)
?query2	http://site.net/dir1/subdir1/file1?query2	The same file but with a different query string. Note that the bookmark reference from the base URL is “stripped off”.
file2	http://site.net/dir1/subdir1/file2	Here we have referred to a file using the name “file2”, which replaces “file1” in the base URL. Here both the query and bookmark are removed.
/file2	http://site.net/file2	Since a single slash was included, this means “file2” is in the root directory; this relative URL replaces the entire <url-path> of the base URL.
..	http://site.net/dir1/	The pair of dots refers to the parent directory of the one in the base URL. Since the directory in the base URL is “dir1/subdir1”, this refers to “dir1”.
../file2	http://site.net/dir1/file2	Specifies that we should go up to the parent directory to find the file “file2” in “dir1”.
../subdir2/file2	http://site.net/dir1/subdir2/file2	Go up one directory with “..”, then enter the subdirectory “subdir2” to find “file2”.
../../dir2/subdir2/file2	http://site.net/dir2/subdir2/file2	Same thing as above but going up two directory levels, then down through “dir2” and “subdir2” to find “file2”.
//file2	http://file2	Two slashes means that “file2” replaces the host name, causing everything to the right of the host name to be stripped. This is probably not what was intended, and shows how important it is to watch those slashes. ☺
//www.newsite.net/otherfile.htm	http://www.newsite.net/otherfile.htm	Here everything but the scheme has been replaced. (In practice this form of relative URL is not that common—the scheme is usually included if the site name is specified, for completeness.)
file2?query2#bookmark2	http://site.net/dir1/subdir1/file2?query2#bookmark2	Here we replace the file name, query name and bookmark name.
ftp://differentsite.net/whatever	ftp://differentsite.net/whatever	Using a new scheme forces the URL to be interpreted as absolute.

Improving Document Portability Using Relative URLs

There is one other very important benefit of using relative URLs: avoiding absolute URLs in a document allows it to be more portable by eliminating “hard-coded” references to names that might change. Going back to our previous example, if the guy maintaining the site “<http://www.longdomainnamesareirritating.com/>” uses only relative links to refer to graphics and other embedded objects, then if the site is migrated to “www.muchshortername.com”, he will not have to edit all of his links to the new name. The significance of this in Web URLs is explored further in [the detailed topic on HTTP URLs](#).



Key Concept: In addition to being more efficient than absolute URLs, relative URLs have the advantage that they allow a resource designer to avoid the specific mention of names. This increases the portability of documents between locations within a site, or between sites.

URL Length and Complexity Issues

Uniform Resource Locators (URLs) are the most ubiquitous form of resource addressing for some very good reasons: they represent a simple, convenient and easy-to-understand way of finding documents. Popularized by their use on the World Wide Web, URLs can now be seen in everything from electronic document lists to television commercials, a testament to their universality and ease of use.

At least, this is true *most* of the time!

When URLs work, they work very well. Unfortunately, there are also some concerns that arise with respect to how URLs are used. Both accidental and intentional misuse of URLs occurs on a regular basis. Part of why I have devoted so much effort to describing URLs is that most people don't really understand how they work, and this is part of why problems occur.

Many of the issues with URLs are directly due to the related matters of *length* and *complexity*. URLs work best when they are short and simple, so it is clear what they are about and so they are easy to manipulate. For example, “<http://www.ibm.com/>” is recognizable to almost everyone as the [World Wide Web \(WWW\)](#) site of the International Business Machines Corporation (IBM). Similarly, you can probably figure out what this URL does without any explanation: “<ftp://www.somecomputercompany.com/drivers/videodivers.zip>”.

However, as we have seen earlier in this section, URLs can be much more complex. In particular, the [common Internet syntax](#) used by protocols such as HTTP and FTP is extremely flexible, containing a large number of optional elements that can be used when required to provide the information necessary for a particular resource access.

Reasons Why Long URLs are Common

The point that many elements in URL syntax are *optional* is important. The majority of the time, most of these optional parts are omitted, which makes URLs much simpler in practical use than they are “on paper”. For example, even though an HTTP URL theoretically contains a user name, password, host, port, path, query and bookmark, most URLs use only a host name and a path. This is what helps keep URLs short and easy to use.

Despite this, you will still find some rather long URLs used on the Internet. Here are some of the most common reasons why.

Long DNS Domain and Host Names

Some people don't realize that long host names are hard to remember. If you run the “Super Auto Body Shop & Pizza Parlor”, having a Web site called “www.superauto.com” will make it easier for your customers to find you than trying to register “www.superautobodyshopand-pizza.com”. Yet DNS names of 15, 20 or even more characters are surprisingly common.

Long Document or Directory Names

Similarly, short file names are better than long ones, and again, many people don't think about this before putting files on the Internet, which makes things more difficult for those who must access them.

Use of “Unsafe” Characters

URLs have [a mechanism for dealing with “unsafe” characters](#), but it makes them longer and harder to decipher. Suppose you have a file named:

“{ABC Corp} budget; draft #3; third quarter 2004.htm”

The URL for this will have to be:

“%7BABC%20Corp%7D%20budget%3B%20draft%20%233%3B%20third%20q
uarter%202004.htm”

The original long file name was readable, but the URL is a mess because of the special character encodings.

Naming the file “ABC budget draft 3, 3Q2004.htm” would be a better choice, and still includes enough information to be understandable. Even better, you could replace the spaces with underscores, to avoid the need for “%20”s entirely: “ABC_budget_draft 3,_3Q2004.htm”.

Parameter Strings

In HTTP URLs, the syntax for specifying a query (following a question mark character) is often used to allow a Web browser to send various types of information to a Web server, especially parameters for interactive queries. These parameter strings can get quite lengthy. For example, I typed in a query to the great Web search engine Google to find recipes for potato salad. This is what the URL for one of the recipe files looks like:

```
“http://groups.google.com/groups?q=%22potato+salad%22&hl=en&lr=&ie=UTF-8&safe=off&selm=B826FB57.89C0%25sbrooks%40ev1.net&rnum=2”.
```

Almost all of that consists of parameters that tell the Google server exactly what document I want based on my query. It is necessary, but still cumbersome.

URL Wrapping and Delimiting Issues

For humans, long and complex URLs are hard to remember and use. In addition to the sheer difficulty of remembering all those characters, there is the issue of URL *wrapping*, which occurs when they are presented in certain forms. Most programs can only display 78 or 80 characters in a single line. If a URL is longer than this, the characters of the URL will “wrap” onto multiple lines; when you read that Google example just above, you probably noticed that.

URL wrapping can lead to mistakes when copying a URL from one form to another, such as if you copied it from this document into your Web browser. If a URL is 81 characters long and 80 are on the first line and the last character on the second line, many users may not realize that the URL has “wrapped” at all. I have seen URLs that are hundreds of characters long, requiring several manual “copy and paste” operations to get the URL to work.

Perhaps surprisingly, some software may not handle this “wrapping” properly either. While this is not a problem when a hyperlink is used in something like an HTML document, it can be troublesome when links are included in an e-mail message or Usenet article.

Another issue is delimiting where a URL starts and ends when it appears. A URL begins with a scheme name that could in theory be used in other contexts that are not URLs. Without a clear way of labeling a URL as being a URL, a software program might not recognize it. Consider discussion of a URL in a document like this one; if I say “Please visit <http://www.thissite.com>; you will see the information you need there”, then we all know the semicolon is part of the sentence and not part of the URL, but a computer program might not be so sure. And again, this problem is worse when a URL is long and complex and wraps on to multiple lines of text?—how does the program recognize the end of the URL?

Explicit URL Delimiting and URL Redirectors

To resolve both the wrapping and delimiting problems, a special URL “super-syntax” is sometimes employed, especially when URLs are used in other text. This is done by surrounding the URL in angle brackets, possibly including the label “URL:” before the scheme name. For example, all of the following are equivalent:

```
http://www.networkingistoodarnedcomplicated.com
```

```
<http://www.networkingistoodarnedcomplicated.com>
```

```
<URL:http://www.networkingistoodarnedcomplicated.com>
```

The angle brackets indicate clearly where the URL begins and ends, making it easier for both programs and humans to deal with long URLs.

Another solution sometimes used for long URLs are *redirection services*, provided by many Web sites. For example, <http://www.tinyurl.com> is a free service that allows someone to create a short URL that automatically loads a resource at a much longer URL.

URL Abbreviation

One final issue I want to discuss isn't related directly to long or complex URLs, but is related indirectly to the matter of length: URL abbreviation. Many people use URLs so often that they become, well, lazy when it comes to specifying URLs. They tend to leave off portions of the full URL syntax to save time and energy. I don't mean by this that they specify relative URLs, but rather, they specify absolute URLs with “missing pieces”.

For example, rather than type “<http://www.sitename.com>”, they might type “<http:www.sitename.com>”, leaving off the two slashes. More commonly, people omit the scheme name entirely, just entering “www.sitename.com”. Technically, this is not a URL, it is just a domain name. However, most Web browsers can handle this, assuming by default that the scheme is “<http://>” if none is provided. (Don't feel bad, I do it too! ☺)

URL Obscuration, Obfuscation and General Trickery

Most of the time, the owner of a resource wants the URL that refers to the resource to be short, simple and easily-understood. Thus, [long and complex URLs](#) are usually the result of necessity, accident or ignorance. Some resources need to have long names for whatever reason, such as the use of the long query string in the Google example; other times, URLs are made long because the owner of the resource doesn't realize that using a long DNS host name or file name will make for a long and unwieldy URL.

Whatever the reasons for these situations, they are not deliberate. Recent years, however, have seen a dramatic rise in the use of *intentionally* long, complex, confusing and deliberately deceptive URLs. These URLs are either structured so that it is impossible to tell what they are, or worse, they are made to appear as if they point to one resource when they really go to another.

Why would people do this? Simple: because they fear being open and honest about their “resources”. And who would these people be? Why, they would be the spammers and con artists who overload our Internet e-mail boxes with offers of every sort imaginable, from making you rich beyond your wildest dreams, to inflating the dimensions of certain body parts to unnatural sizes...

They are afraid that if the URL indicated clearly what the “resource” was, you might not click on the link; or that if you identify them as a spammer you might filter out their e-mail. They also figure that if they can make the URL appear to be something interesting, you'll load it. Even if it turns out to be something you didn't expect, maybe you'll pay attention anyway.

(You mean you are too smart to be tricked into buying a product through a deceptive URL? And you would never support a spammer anyway? What a coincidence, same with me! Yet the spam keeps coming; it must work or they wouldn't keep doing it... would they? ☺)

Common Obscuration and Obfuscation Techniques

It is a cruel irony that [the complex syntax that was built into URLs](#) to allow them to be so flexible, has been exploited by the obnoxious into tricking people. They know that most people are used to seeing simple URLs like “http://www.myfavoritesite.com” and do not realize that the full URL syntax allows the same resource to be specified in literally millions of different ways.

So these people, desperate for hits to their Web sites at any cost, keep coming up with new tricks for manipulating URLs. These are focused on HTTP scheme URLs, though in theory the tricks can be applied to several other types as well (though obviously they won't work with some schemes). Here are some of the more common gimmicks that have been used, past and present (note that if you are trying these out as you read, some examples may not work on certain browsers):

Excessive Length

In some cases, a URL is just made really long by the addition of lots of gibberish as a “query string”, so that the user's eyes glaze over just looking at it. This is a relatively “unsophisticated” technique, however, since one can easily tell what the real host name is by looking at the start of the URL. Most of the better scammers have moved beyond such simple tricks today.

Regular IP Address Hosts

Internet users are so accustomed to using [DNS names](#) that they don't realize that one can access a URL using an IP address at all. So most people don't realize that The PC Guide can be accessed as easily using <http://209.68.14.80> as <http://www.PCGuide.com>. (Note that this is not true of all Internet hosts; those that use virtual names cannot be accessed using just an IP address.)

This is not really trickery per se. It is quite legitimate, and in some ways even necessary—for example, for accessing a site that is having DNS problems. The problem here is that usually one cannot tell what a site is from the IP address alone, and many people will just click on an IP address link without bothering to find out what it is.

Numeric Domain Names

It is possible to register a DNS domain name consisting of just a single number. For example, one could register “114.com”. And then one could create subdomains within it such as “42.12.205.114.com”. At first glance this appears to be an IP address specification, so someone might think it would resolve to the address 42.12.205.114—when in reality, it is some other address.

I believe that DNS name registrars have been cracking down on this sort of trickery, so it may not be as prevalent now as it once was.

Bogus Authentication Information

HTTP URLs theoretically support the inclusion of authentication information, by including “<user>:<password>@” before the host in the URL. Yet the vast majority of Web sites are “open” and neither require nor use it. If you specify an authentication string and it is not needed, it is ignored.

This is one of the most popular techniques at present. One way it is used is by including “authentication information” that looks like a “benign” host, to make the user think the URL is for that host. For example, if I wanted to trick you into visiting The PC Guide, I might use this URL to make it look like clicking it would go to CNN:

```
<http://www.cnn.com@www.PCGuide.com>
```

This is still too obvious, however, so this “method” is often combined with some of the techniques below.

Deceptive Character Encoding

The use of the percent sign to [encode special characters](#) such as spaces and punctuation can also be **abused** to obscure the name of a domain. For example, the following is another way of expressing the DNS name for The PC Guide:

```
<http://%57%57%57.%50%43%47%55%49%44%45.%43%4F%4D>
```

Try it. ☺

IP Address Math Trickery

Okay, this is where things get **really** bizarre. Most of the time, we express an IP address as a [dotted decimal number](#). Remember, however, that to computers, the IP address is just a 32-bit binary number. Most browsers support a rather shocking number of methods for

expressing these numbers. This is unfortunate, because this flexibility is really not needed and almost never used for legitimate purposes. It can lead to some really bizarre URLs that are unrecognizable, or that look like regular IP addresses but are not.

Here are some examples, all of which are the same as the IP address form of The PC Guide (<http://209.68.14.80>):

- ☉ **IP Address in Dotted Octal:** A leading zero signifies an IP address where each byte is in octal:

<http://0321.0104.016.0120>

- ☉ **IP Address in Dotted Hexadecimal:** A leading zero followed by an “x” signifies an IP address where each byte is in hexadecimal:

<http://0xD1.0x44.0x0E.0x50>.

- ☉ **IP Address As Single Number:** We can even take the entire 32-bit number and express it as a single number and that will work too. In decimal:

<http://3510898256/>

In octal:

<http://032121007120/>

And, in hexadecimal:

<http://0xd1440e50/>.

Making Matters Worse: Combining Deceptive Tricks

As if these tricks weren't bad enough taken individually, we can have some real fun by **combining** them! For example, start with the regular PC Guide URL:

<http://www.PCGuide.com>

And convert it to IP:

<http://209.68.14.80>

Then add some bogus authentication gibberish:

<http://www.cnn.com@209.68.14.80>

And convert the real URL into a single number so it looks like a document on the CNN web site:

<http://www.cnn.com@3510898256>

Alternately, we can use the octal form, and even include lots of extra leading zeroes just for fun:

```
<http://www.cnn.com@0000000000000321.00000000104.00000000000016.00000120>
```

Believe it or not, this is just the tip of the iceberg. In some browsers, even the IP address numbers can be expressed using “percent sign” ASCII encoding!

While quite irritating, I must give these people points for creativity at least—some of the tricks are quite ingenious. At the same time, their inventiveness is potentially hazardous. While these false URLs are usually more a waste of time than anything harmful, there are sometimes good reasons a person would go to great lengths to hide the identity of a resource. Deceptive URLs are just one more danger that network administrators must deal with today.



Key Concept: The syntax of Internet URLs includes many elements that provide great flexibility in how URLs can be constructed. Unfortunately, these capabilities of expression are now often abused by people who create intentionally obfuscated URLs to trick users into accessing their Web sites and other resources. Some of these can be potentially hazardous, which means that care is required before clicking unknown links or accessing strange URLs.



Uniform Resource Names (URNs)

“HTTP 404 - NOT FOUND”

Have you ever tried to access a Web site or other Internet resource, only to see those dreaded words appear? You probably have, and in seeing them, you have experienced first-hand one of the most common problems with [Uniform Resource Locators \(URLs\)](#).

URLs specify a resource using two key pieces of information: the resource's location, and a method by which the resource may be accessed or retrieved. This focus on the means of access for the resource makes URLs very practical, in that the URL usually contains all the data we need to use the resource. This is why URLs are so widely used today. However, this “access orientation” also means that URLs have a number of serious limitations.

The Problem With URLs

The main difficulty with URLs is that since they describe a resource based on its location, they tie the resource and its location together inextricably. While this may not seem to be a big deal, it is actually a fairly serious matter in a number of ways, because a resource and its location are not the same thing. It is only because most Internet resources rarely change location that we don't notice this issue more often with URLs.

Suppose that your name is Joe Xavier Zachariah and you live at 44 Glendale Crescent in Sydney, Australia. If someone asked you who you were, would you say “Joe Xavier Zachariah”, or “the man living at 44 Glendale Crescent in Sydney, Australia”? Almost certainly, the former; but a URL would be like describing yourself as a “resource” using the latter description.

Since we realize that Mr. Zachariah is obviously not always going to be at 44 Glendale Crescent, we know that describing him using just a location is not sufficient. The same thing occurs with Internet resources when they are identified using only location.

However, the problem with Internet resources and URLs goes beyond just the matter of movement. Consider a situation where a particular resource is very popular; we might want to duplicate the same resource in multiple locations. Using URLs, we would need a different identifier for each copy of the resource, even though each copy is the same. Again, the problem is that we are not identifying the resource itself but rather the place where it can be found.

Overview of URNs

In recognition of this issue, an alternative identification mechanism for Internet resources was developed, called *Uniform Resource Names (URNs)*. The basic standard describing URNs is RFC 1737, *Functional Requirements for Uniform Resource Names*, which was published in 1994. In 1997, RFC 2141 was published, which specifies the syntax of URNs.

As you can probably tell from that term, a URN is intended to label a resource based on its actual identity, rather than where it can be found. So, where a URL is like Joe Zachariah's address, a URN would be his name. Or, as I gave as an example in [the overview of URIs](#), a URN would be identifying a book based on its ISBN number rather than specifying what bookshelf it is on in a building.

To be useful in identifying a particular resource, it is necessary that a URN be globally unique, and that's not always as simple as it may at first appear. Consider human names, for example. Even though there is probably only one Charles Marlin Kozierek in the entire world, if your name is John Paul Smith or José Garcia, you likely share that name with thousands of others. This means using common names may not be sufficient for identifying human “resources” and some other method might need to be devised.

URN Namespaces and Syntax

There are many types of resources that URNs are intended to identify on the Internet, each of which may require a different form of naming. To allow URNs to represent many kinds of resources, numerous URN *namespaces* are defined. A namespace is referenced using a unique string that tells the person or computer interpreting the URN what type of resource the URN identifies. The namespace also ensures the uniqueness of URNs, when a particular identifier might exist in more than one context. For example, both North American telephone numbers and ISBN numbers consist of ten digits, so a particular number such as “4167819249” could represent both a telephone number and a book number; the namespace identifier tells us what the number means when it is encountered in a URN.

The general syntax of a URN is:

URN:<namespace-ID>:<resource-identifier>

For example, a book with the ISBN number 0-679-73669-7 could be represented as:

URN:isbn:0-679-73669-7

This string identifies that particular book uniquely, wherever it might happen to be in the world. Many other namespaces have also been defined to specify the URNs for other types of resources, such as documents on the Internet.



Key Concept: Where Uniform Resource Locators (URLs) specify a resource based on an access method and location, *Uniform Resource Names (URNs)* identify a resource by name. A URN consists of a *namespace identifier*, which indicates what type of name it contains, and a *resource identifier* that specifies the individual resource within the context of that namespace.

URN Resolution and Implementation Difficulties

URNs are a more “natural” way of identifying resources, which gives them intuitive appeal. Despite this, URNs are still not widely used, even though they have been in development for over a decade. The main reason for this is somewhat ironic: it is in fact because of the fact that URNs are independent of location. The very characteristic that provides URNs with identification advantages over URLs also makes URNs much harder to use practically, which has led to long delays in workable URN systems.

To understand the problem, consider the example string “URN:isbn:0-679-73669-7”. This uniquely identifies a particular book, and will always refer to it no matter where the book may be, unlike a URL. The problem is that while the URL-equivalent tells us how to actually find this book, the URN does not. The same thing goes for our human example before: identifying Joe Xavier Zachariah by his name is more “sensible” than identifying him as “the man living at 44 Glendale Crescent in Sydney, Australia”, but at least with the latter, we know where Joe is!

In order for URNs to be useful on an internetwork, they require an additional mechanism for translating a simple URN identification string into a particular location and/or access method. In other words, we need to be able to change a URN into the equivalent of a URL, so that the resource can be found. This requirement is analogous to the problem of [resolving Internet DNS domain names into IP addresses](#), and the same term is used to describe it: URN *resolution*.

Ideally, we want to be able to use some sort of technique where we specify the name “Joe Xavier Zachariah” and we are told where Joe is so we can find him. Or, we provide the string “URN:isbn:0-679-73669-7” and are provided with a list of libraries or other places where the book can be found. The power of URNs can also be exploited in such a system, by having the resolution system specify the location of a copy of the resource that is closest (in terms of network distance, cost or other measurements) to the entity making the request.

However, setting up URN resolution mechanisms is a non-trivial task. The matter of URN resolution has been the subject of much of the work on URNs over the last decade. RFC 2483, *URI Resolution Services Necessary for URN Resolution*, was published in 1999 and discusses some of the important issues in URN resolution. In October 2002, a series of RFCs, 3401 to 3405, defined a new system called the *Dynamic Delegation Discovery System (DDDS)* that was designed not just to resolve URNs, but to handle the entire class of resolution problems where an identifier is given and the output is information about where to get more information about that identifier. RFC 3406 was published at the same time, providing more information about URN namespaces.



Key Concept: Since URNs identify resources by name rather than location, they are a more *natural* way of identifying resources than using URLs. Unfortunately, this advantage is also a disadvantage, since URNs don't, by themselves, provide a user with the necessary information to find the resource so it can be used. A process of *URN resolution* must be performed to transform the URN into a set of information that allows the resource to be accessed.

Although progress on URNs has been slow, it has been steady. While it may yet be a few years before URNs are widely used, I believe it is likely that they will play an increasingly prominent role in identifying resources on the Internet in the future.



TCP/IP File and Message Transfer Applications and Protocols (FTP, TFTP, Electronic Mail, USENET, HTTP/WWW, Gopher)

The purpose of networking applications is to allow different types of information to be sent between networked devices. In the world of computers, information is most often arranged into discrete units called *files*. When those files are created specifically for the purpose of communication, they are often called *messages*. One of the most important groups of TCP/IP applications is the one that describes the basic mechanisms for moving these files between internetworked devices: *file and message transfer applications*.

In this section I describe in detail the most important applications used in TCP/IP for file and message transfer, and the protocols that implement them. I begin with an overview of these applications, and a description of the differences between them. I then include four subsections that describe the four most important file/message transfer application families: explicit file transfer, electronic mail, network news (Usenet) and hypertext (the World Wide Web). I also provide a brief look at the Gopher protocol, which has fallen out of favor but is worth a quick mention, especially due to its role as an historical precursor of the Web.



Related Information: I have made the decision to draw a distinction between application protocols that are normally used **explicitly** by a user to move messages and files, and those that are used **implicitly** to share files. The former usually use specific commands to transfer data and are described in this section. The latter work by creating the appearance to the user that a file on a remote device is actually local, by transmitting commands and data over the network automatically, and are described in a separate section on [network file and resource sharing protocols](#). In TCP/IP, this sharing function is most often performed by the [Network File System \(NFS\)](#).

File and Message Transfer Overview and Application Categories

I said in [the introduction to this section](#) that file and message transfer applications are one of the most important types used in TCP/IP. Transferring files between networked computers is the most basic type of network communication. In fact, it wouldn't even be an exaggeration to say that this may be **the** most important class of internetworking applications. Some of the members of this group are so common that many people use them every day without even thinking about it.

To understand these applications, let's first take a quick step back to look at the fundamental concept of a "file". Simply put, a file is just a collection of information that is treated as a single unit by a computer system. Files are stored in directories or folders in a *file system*. In modern computers, files are normally expressed as a sequence of bytes or characters, and each file is read, written, copied or otherwise manipulated as an independent object. In addition to the data it contains, each file has associated with it file *attributes* that describe it.

For our purposes, the critical characteristic of a file is that it is a self-contained object carrying arbitrary information. Since files are the building blocks of information in computer systems, it's no surprise that the transfer of information in networking was originally defined in terms of the movement of these files. Some of the protocols describing how to transfer files predate all of the modern protocols in the lower levels of TCP/IP, including [IP version 4](#), [TCP](#) and [UDP](#). It's not the case that file transfer was an early application of internetworking, but that internetworking was invented in large part to permit file transfer!

Files in modern computing systems are inherently designed to be generic; they can contain any type of information. The significance of the contents of a file depends entirely on the user or software program that examines it. The TCP/IP file and message transfer protocols have in common the notion of moving files from one computer to another. Where they differ is in how the files are handled and processed. There are two basic approaches: general file transfer, and message transfer.

General File Transfer

General transfer applications normally treat the file as a "black box", moving them from place to place and paying little or no attention to what the files contain. The TCP/IP [File Transfer Protocol \(FTP\)](#) and [Trivial File Transfer Protocol \(TFTP\)](#) fall into this category. FTP has been around in one form or another for over 30 years now and is still widely used.

Message Transfer

Other TCP/IP applications work with particular types of files, processing and interpreting them in various ways. These files are usually designed for the specific purpose of communication, and are thus called *messages*; these applications allow users to construct, send and receive messages that fit a particular message format. There are several prominent TCP/IP messaging applications we'll examine in this Guide:

-
- ☉ **Electronic Mail (E-Mail):** A system that allows users to exchange “letters” (in fact any type of document) in a manner equivalent to the conventional postal system, but with the advantages of great speed and simplicity. Electronic mail has not replaced regular mail entirely, but many people now use it for the vast majority of their correspondence.
 - ☉ **Network News (Usenet):** An application that is like electronic mail in that it allows users to send messages. However, while e-mail is normally used to allow a message to be sent to one user or a small number of recipients, [network news is a way for thousands of users to share messages](#) on various topics. Any user can contribute a message that can be seen by others, any of whom can respond. Unlike the case with e-mail, recipients do not need to be explicitly identified, which makes network news far more suitable to communication amongst large groups of people who may not even know each other. This was one of the first TCP/IP applications to create something like an “electronic bulletin board”: an online community.
 - ☉ **Hypertext (World Wide Web):** You probably don't even need me to explain what the [World Wide Web](#) is, such is its great significance in modern internetworking. Hypertext moves the idea of messaging beyond the simple exchange of text messages or plain files, to the notion of *rich* messages that can contain a variety of types of information. This includes text, graphics, multimedia and embedded files. Most importantly, hypertext allows one document to be linked to another, forming the “web” of related documents that led to the name “World Wide Web”. The Web is almost certainly the single most important TCP/IP application, used daily by millions of people.

Each of these applications was at one point somewhat distinct, but in recent years a number of developments have caused the lines between them to become greatly blurred. Electronic mail is no longer limited to simple text messages; it can now be used to carry general files by encoding them into text form using special methods, and even to carry hypertext documents. World Wide Web clients (browsers) continue to be enhanced to let them access other types of servers and files, and can also be used for general file transfer. These developments all mean even more functionality and flexibility for the TCP/IP user—and a bit more care required on the part of the TCP/IP learner.



Key Concept: One of the most important groups of TCP/IP applications is the one that enables files to be moved between devices on an internetwork: *file and message transfer* applications. This group contains many of the common applications that TCP/IP users employ every day to communicate. It can be broken into two main categories: *general file transfer* applications that are used to move any type of file between devices, and *message transfer* applications, which allow different types of communication using special file types, such as electronic-mail messages or hypertext files.



TCP/IP General File Transfer Protocols (FTP and TFTP)

As I mentioned in [the preceding overview of file and message transfer protocols](#), they represent the most basic type of network communication: the simple movement of blocks of data. Of the many file and message transfer methods, the most fundamental application is what I call *general file transfer*. General file transfer protocols perform one main function: allowing files to be copied from one computer to another.

Since file transfer protocols move files from place to place without considering their contents much, they are relatively “unsophisticated” compared to certain message-processing applications. However, the idea of being able to move files around is so important that general file transfer protocols were one of the very first applications in inter-networking. While many people now use electronic mail or Web browsers to perform the functions formerly performed exclusively using general file transfer, these older protocols are still very important and widely used, and important to understand.

In this section I take a look at the two TCP/IP general file transfer protocols. The first is called simply the File Transfer Protocol (FTP). The second is called the Trivial File Transfer Protocol (TFTP). Each is described in its own subsection.

The relationship between FTP and TFTP is similar to that of the [Transmission Control Protocol \(TCP\)](#) and [User Datagram Protocol \(UDP\)](#) at layer four. FTP is full-featured, session-oriented and somewhat complex. It is the more often-used of the two protocols, providing a full command interface and taking advantage of the reliability and stream transfer functions of [TCP](#), over which it runs. TFTP, like the [UDP](#) it uses at the transport layer, is a “stripped down” version of FTP. It has far fewer commands and capabilities than FTP, but is ideal for cases where simplicity and small software program size is important, such as embedded software in devices.

File Transfer Protocol (FTP)

The primary general file transfer protocol in the TCP/IP suite shows its “generality” directly through its unqualified name: the *File Transfer Protocol (FTP)*. FTP is one of the most widely used application protocols in the world. It was designed to allow the efficient transfer of files between any two devices on a TCP/IP internetwork. It automatically takes care of the details of how files are moved, provides a rich command syntax to allow various supporting file operations to be performed (such as navigating the directory structure and deleting files) and operates using the TCP transport service for reliability.

In this section I describe the operation of the File Transfer Protocol. I begin with an overview of FTP, a discussion of its long history and the standards that define it. I then describe how FTP works in two subsections. The first discusses the key concepts behind how FTP functions and discusses its operation in general terms. The second provides specific details of FTP commands and reply codes. Finally, I provide a sample illustration of a user FTP session showing the internal commands used for each action.

FTP Overview, History and Standards

The [TCP/IP protocol suite](#) as we know it today was developed in the late 1970s and early 1980s, with the watershed event probably the publishing of the version 4 standards of the Internet Protocol and Transmission Control Protocol in 1980. Modern TCP/IP was the result of [experimentation and development work](#) that had been underway since the 1960s. This work included both the design and implementation of the protocols that would implement internetworks, and also the creation of the first networking applications to allow users to perform different tasks.

FTP Development and Standardization

The developers of early applications conceptually divided methods of network use into two categories: *direct* and *indirect*. Direct network applications let a user access a remote host and use it as if it were local, creating the illusion that the network doesn't even exist (or at least, minimizing the importance of distance). Indirect network use meant getting resources from a remote host and using them on the local system, then transferring them back. These two methods of use became the models for the first two formalized TCP/IP networking applications: [Telnet](#) for direct access and the *File Transfer Protocol (FTP)* for indirect network use.

The first FTP standard was RFC 114, published in April 1971, before TCP and IP even existed. This standard defined the basic commands of the protocol and the formal means by which devices communicate using it. At this time the predecessor of TCP (called simply the *Network Control Protocol* or *NCP*) was used for conveying network traffic. There was no Internet back then. Its precursor, the ARPAnet, was tiny, consisting of only a small group of development computers.

A number of subsequent RFCs refined the operation of this early version of FTP, with revisions published as RFC 172 in June 1971 and RFC 265 in November 1971. The first major revision was RFC 354, July 1972, which for the first time contained a description of the overall communication model used by modern TCP, and details on many of the current features of the protocol. In subsequent months many additional RFCs were published, defining features for FTP or raising issues with it. RFC 542, August 1973, the FTP specification looks remarkably similar to the one we use today, over three decades later, except that it was still defined to run over NCP.

After a number of subsequent RFCs to define and discuss changes, the formal standard for modern FTP was published in RFC 765, *File Transfer Protocol Specification*, June 1980. This was the first standard to define FTP operation over modern TCP/IP, and was created at around the same time as the other primary defining standards for TCP/IP.

RFC 959, *File Transfer Protocol (FTP)*, was published in October 1985 and made some revisions to RFC 765, including the addition of several new commands, and is now the base specification for FTP. Since that time a number of other standards have been published that define extensions to FTP, better security measures and other features. (Some of these are discussed in the [general operation section](#) in the appropriate places.)

Overview of FTP Operation

FTP was created with the overall goal of allowing indirect use of computers on a network, by making it easy for users to move files from one place to another. Like most TCP/IP protocols, it is based on a [client/server model](#), with an FTP client on a user machine creating a connection to an FTP server to send and retrieve files to and from the server. The main objectives of FTP were to make file transfer simple, and to shield the user from implementation details of how the files are actually moved from one place to another. To this end, FTP is designed to automatically deal with many of the issues that can potentially arise due to format differences in files stored on differing systems.

To ensure that files are sent and received without loss of data that could corrupt them, FTP uses the reliable [Transmission Control Protocol \(TCP\)](#) at the transport layer. An authentication system is used to ensure that only authorized clients are allowed to access a server. At the same time, a feature sometimes called *anonymous FTP* allows an organization that wishes it to set up a general information server to provide files to anyone who might want to retrieve them.

After a TCP connection is established, an [FTP control connection is created](#). Internal FTP commands are passed over this logical connection based on formatting rules established by the Telnet protocol. Each command sent by the client receives a reply from the server to indicate whether it succeeded or failed. A [data connection](#) is established for each individual data transfer to be performed. FTP supports either normal or passive data connections, allowing either the server or client to initiate the data connection. [Multiple data types](#) and file types are supported to allow flexibility for various types of transfers.

The interface between an FTP user and the protocol is provided in the form of a set of [interactive user commands](#). After establishing a connection and completing authentication, two basic commands can be used to send or receive files. Additional support commands are provided to manage the FTP connection, as well as to perform support functions such as listing the contents of a directory or deleting or renaming files. In recent years, graphical implementations of FTP have been created to allow users to transfer files using mouse clicks instead of memorizing commands. FTP can also be used directly by other applications to move files from one place to another.



Key Concept: The most important general file transfer protocol in TCP/IP is the simply-named *File Transfer Protocol (FTP)*. The need to be able to move files of any type between machines is so fundamental that FTP's history goes back more than 30 years. FTP runs over TCP, to ensure that files are transferred reliably with no data loss. The protocol uses a set of *FTP commands* sent from an FTP client to an FTP server to perform file transfer operations; the FTP server sends to the client *FTP replies* that indicate the success or failure of commands.



FTP Concepts and General Operation

The developers of the File Transfer Protocol (FTP) had to balance the need for a rich set of functionality with the desire for a protocol that was as simple and easy to implement as possible. FTP is therefore not nearly as simple as its “little brother”, the [Trivial File Transfer Protocol \(TFTP\)](#), but given what the protocol can do, it's much less complicated than one might expect. The operation of the protocol can in fact be broken down into a number of rather straight-forward elements that work together to establish connections and pass commands and data.

In this section I describe the most important concepts behind the File Transfer Protocol and explain its operation in general terms. I begin with a discussion of the FTP communication and operational model, which shows the internal components of the protocol and how they communicate over the internetwork. I describe the process by which FTP control connections are established, and how user authentication is performed. I explain the two main methods of creating data connections (normal and passive) and discuss the issues that pertain to when each is used. I then describe how FTP communication works in general and the various transmission modes. I conclude with a discussion of the different options for data representation used for files sent with FTP.



Related Information: In this section I will make limited mention of commands used to communicate between an FTP client and server. The details of FTP commands can be found in [a separate section](#).

FTP Operational Model, Protocol Components and Key Terminology

The standards that define the File Transfer Protocol (FTP) describe its overall operation using a simple conceptual tool called the *FTP model*. This model defines the roles of the devices that participate in a file transfer, and the two communication channels that are established between them. It also describes the components of FTP that manage these channels, and defines the terminology used for the components. This makes it an ideal place for us to see how FTP works in broad terms.

The Server-FTP Process and User-FTP Process

FTP is a classical client/server protocol, as I mentioned in the [overview](#). However, the client is not called by that name but rather is called the *user*. The name comes from the fact that the human user that issues FTP commands works on the client machine. The full set of FTP software operating on a device is called a *process*. The FTP software on the server is called the *Server-FTP Process*, while the software on the client is the *User-FTP Process*.



Key Concept: The FTP client is sometimes called the *user device*, since the human user interacts with the client directly. The FTP client software is called the *User-FTP Process*; the FTP server software, the *Server-FTP Process*.

FTP Control Connection and Data Connection

A critical concept in understanding FTP is that while it uses TCP like many other applications, it does **not** use just one TCP connection for all communication the way most protocols do. The FTP model is designed around **two** logical channels of communication between the server and user FTP processes:

- ☉ **Control Connection:** This is the main logical TCP connection that is created when an FTP session is established. It is maintained throughout the FTP session and is used only for passing control information, such as FTP commands and replies. It is not used to send files.
- ☉ **Data Connection:** Each time that data is sent from the server to the client or vice-versa, a distinct TCP data connection is established between them. Data is transferred over this connection. When the file transfer is complete, the connection is terminated.

The reason for having these separate channels is that it provides flexibility in how the protocol is used, as we will see later in this section. It does, however, add complexity to FTP.



Key Concept: Unlike most protocols, FTP does not use a single TCP connection. When a session is set up, a permanent *control connection* is established using TCP, for passing commands and replies. When files or other data are to be sent, they are passed over separate TCP *data connections* that are created and then dismantled as needed.

FTP Process Components and Terminology

Since the control and data functions are communicated using distinct channels, the FTP model divides the software on each device into two logical protocol components that are responsible for each channel. The *protocol interpreter (PI)* is a piece of software that is charged with managing the control connection, issuing and receiving commands and replies. The *data transfer process (DTP)* is responsible for actually sending and receiving data between the client and server. In addition to these two elements, the user FTP process includes a third component, a *user interface*, that interacts with the human FTP user; it is not present on the server side.

Thus, there are two server process components and three client (user) process components in FTP. These components are referred to in the FTP model by specific names, which are used in the standard to describe the detailed operation of the protocol. I plan to do the same in this section, so I will now describe more fully the components in each device of this model, which are illustrated in [Figure 288](#).

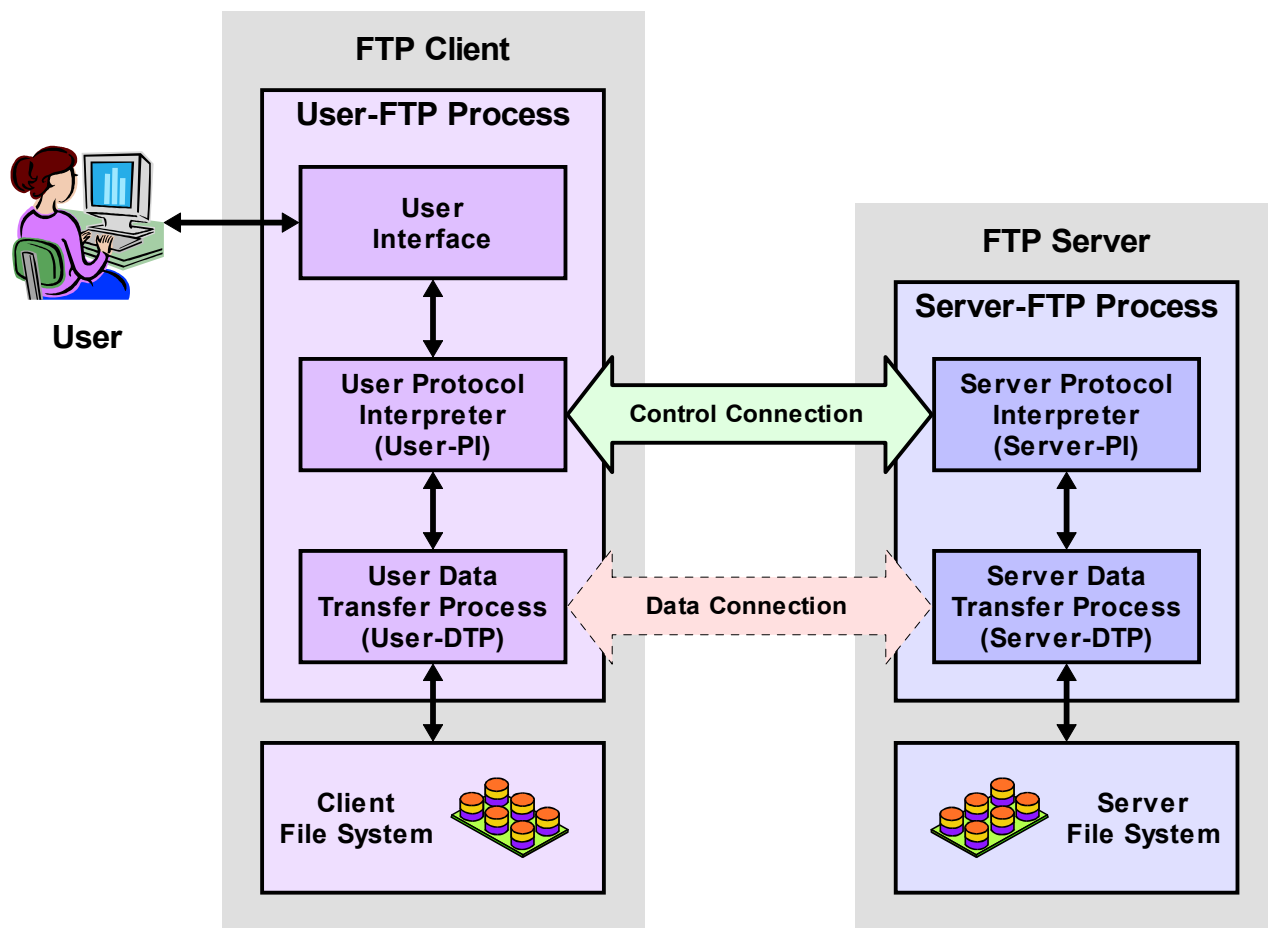

Figure 288: File Transfer Protocol (FTP) Operational Model

FTP is a client/server protocol, with communication taking place between the *User-FTP Process* on the client and the *Server-FTP Process* on the server. Commands, replies and status information are passed between the *User-PI* and *Server-PI* over the *control connection*, which is established once and maintained for the session. Data is moved between devices over *data connections* that are set up for each transfer.

Server-FTP Process Components

The Server-FTP Process contains these two protocol elements:

- ☉ **Server Protocol Interpreter (Server-PI):** The protocol interpreter responsible for managing the control connection on the server. It listens on the main reserved FTP port for incoming connection requests from users (clients). Once a connection is established, it receives commands from the User-PI, sends back replies, and manages the server data transfer process.

-
- ④ **Server Data Transfer Process (Server-DTP):** The DTP on the server side, used to send or receive data to or from the User-DTP. The Server-DTP may either establish a data connection or listen for a data connection coming from the user. It interacts with the server's local file system to read and write files.

User-FTP Process Components

The User-FTP Process contains these three protocol elements:

- ④ **User Protocol Interpreter (User-PI):** The protocol interpreter responsible for managing the control connection on the client. It initiates the FTP session by issuing a request to the Server-PI. Once a connection is established, it processes commands received from the user interface, sends them to the Server-PI, and receives back replies. It also manages the user data transfer process.
- ④ **User Data Transfer Process (User-DTP):** The DTP on the user side, which sends or receives data to or from the Server-DTP. The User-DTP may either establish a data connection or listen for a data connection coming from the server. It interacts with the client device's local file system.
- ④ **User Interface:** The user interface provides a more “friendly” FTP interface to a human user. It allows simpler user-oriented commands to be used for FTP functions rather than the somewhat cryptic internal FTP commands, and also allows results and information to be conveyed back to the person operating the FTP session.



Key Concept: The Server-FTP Process and User-FTP Process both contain a *Protocol Interpreter (PI)* element and a *Data Transfer Process (DTP)* element. The *Server-PI* and *User-PI* are logically linked by the FTP control connection; the *Server-DTP* and *User-DTP* by data connections. The User-FTP Process includes a third component, the *User Interface*, which provides the means for the human user to issue commands and see responses from the FTP software.

Third-Party File Transfer (Proxy FTP)

The FTP standard actually defines a separate model for an alternative way of using the protocol. In this technique, a user on one host performs a file transfer from one server to another. This is done by opening two control connections: one each from the User-PI on the user's machine to the two Server-PI's on the two servers. Then, a Server-DTP is invoked on each server to send data; the User-DTP is not used.

This method, sometimes called *third-party file transfer* or *proxy FTP*, is not widely used today. A major reason for this is that it raises security concerns, and has been exploited in the past. Thus, while I felt it was worth mentioning, I will not be discussing it further in my coverage of FTP.

FTP Control Connection Establishment, User Authentication and Anonymous FTP Access

The [FTP operational model](#) describes the distinct logical data and control channels that are established between an FTP client (user) and an FTP server. Before the data connection can be used to send actual files, the control connection must be established. A specific process is followed to set up this connection and thereby create the permanent FTP session between devices that can be used for transferring files.

As with other client/server protocols, the FTP server assumes a passive role in the control connection process. The server protocol interpreter (Server-PI) “listens” on the special [well-known TCP port](#) reserved for FTP control connections: port 21. The User-PI initiates the connection by opening a TCP connection from the user device to the server on this port. It uses an [ephemeral port number](#) as its source port in the TCP connection.

Once TCP has been set up, the control connection between the devices is established, allowing commands to be sent from the User-PI to the Server-PI, and reply codes to be sent back in response. The first order of business after the channel is operating is *user authentication*, which the FTP standard calls the *login sequence*. There are two purposes for this process:

- ① **Access Control:** The authentication process allows access to the server to be restricted to only authorized users. It also lets the server control what types of access each user has.
- ② **Resource Selection:** By identifying the user making the connection, the FTP server can make decisions about what resources to make available to the user.

FTP Login Sequence and Authentication

FTP’s regular authentication scheme is quite rudimentary: it is a simple “username / password” login scheme, shown in [Figure 289](#). Most of us are familiar with this type of authentication for various types of access, on the Internet and elsewhere. First, the user is identified by sending a user name from the User-PI to the Server-PI using the *USER* command. Then, the user’s password is sent using the *PASS* command.

The server checks the user name and password against its user database, to verify that the connecting user has valid authority to access the server. If the information is valid, the server sends back a greeting to the client to indicate that the session is opened. If the user improperly authenticates (by specifying an incorrect user name or password), the server will request that the user attempt authorization again. After a number of invalid authorization tries, the server may time out and terminate the connection.

Assuming that the authentication succeeds, the server then sets up the connection to allow the type of access to which the user is authorized. Some users may have access to only certain files or certain types of files. Some servers may allow particular users to read and write files on the server, while other users may only retrieve files. The administrator can thus tailor FTP access as needed.

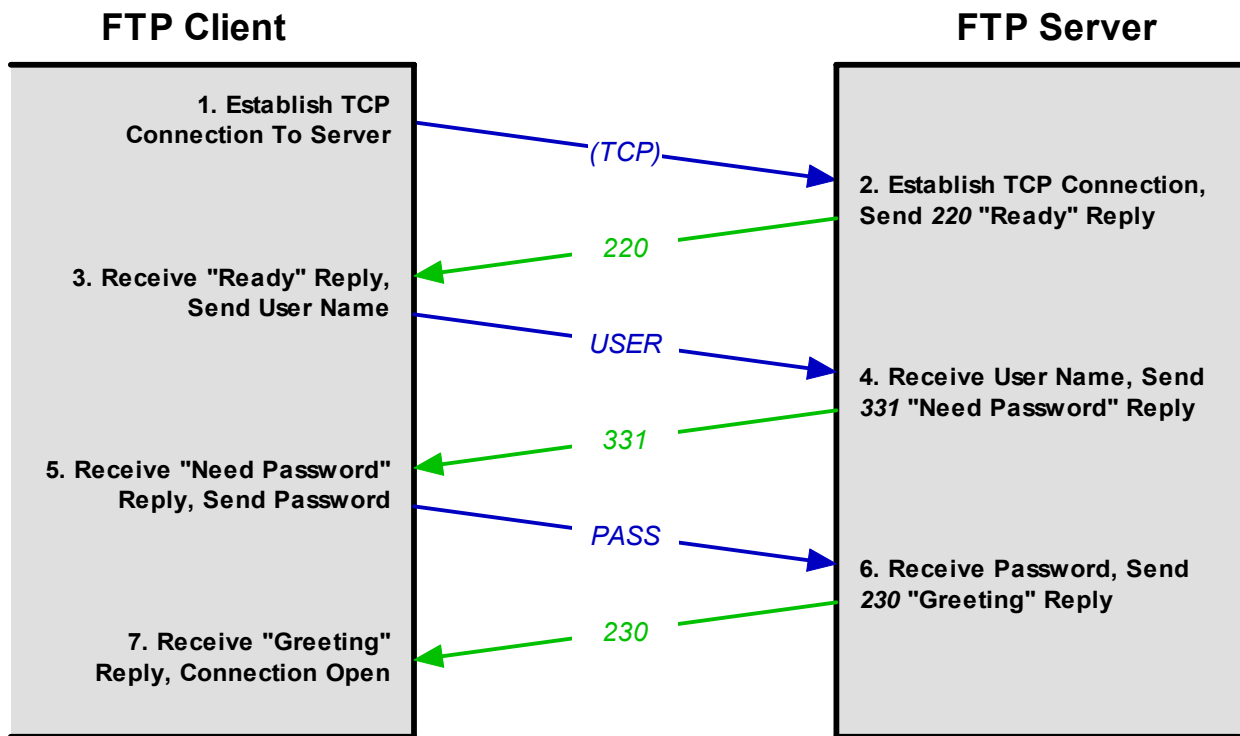

Figure 289: FTP Connection Establishment and User Authentication

An FTP session begins with the establishment of a TCP connection between the client and server. The client then sends the user name and password to authenticate with the server. Assuming that the information is accepted by the server, it sends a greeting reply to the client and the session is open.

Once the connection is established, the server can also make resource selection decisions based on the user's identity. For example, on a system with multiple users, the administrator can set up FTP so that when any user connects, he or she automatically is taken to his or her own "home directory". The optional *ACCT* (account) command also allows a user to select a particular account if he or she has more than one.

FTP Security Extensions

Like most older protocols, the simple login scheme used by FTP is a legacy of the relatively "closed" nature of the early Internet. It is not considered secure by today's global Internet standards, because the user name and password are sent across the control connection in clear text. This makes it relatively easy for login information to be intercepted by intermediate systems and accounts to be compromised. RFC 2228, *FTP Security Extensions*, defines more sophisticated authentication and encryption options for those who need added security in their FTP software.



Key Concept: An FTP session begins with the establishment of a control connection between an FTP client and server. After the TCP connection is made, the user must *authenticate* with the server, using a simple user/password exchange between client and server. This provides only rudimentary security, so if more is required, it must be implemented using FTP security extensions or through other means.

Anonymous FTP

Perhaps surprisingly, however, many organizations did not see the need for this enhanced level of security. They in fact went in the opposite direction: using FTP without any authentication at all. This may seem surprising; why would anyone want to allow just anybody to access their FTP server? The answer is pretty simple, however: anyone who wants to use the server to provide information to the general public.

Today, most organizations use the [World Wide Web](#) to distribute documents, software and other files to customers and others who want to obtain them. But in the 1980s, before the Web became popular, FTP was the way that this was often done. For example, today, if you have a 3Com network interface card and want a driver for it, you would go to the Web server www.3com.com, but several years ago, you might have accessed the 3Com FTP server ([ftp.3com.com](ftp://ftp.3com.com)) to download a driver for it.

Clearly, requiring every customer to have a user name and password on such a server would be ridiculous. For this reason, RFC 1635 in 1994 defined a use for the protocol called *anonymous FTP*. In this technique, a client connects to a server and provides a default user name to log in as a *guest*. Usually the names “anonymous” or “ftp” are supported. Seeing this name, the server responds back with a special message, saying something like “Guest login ok, send your complete e-mail address as password.” The password in this case isn't really a password, of course, it is just used to allow the server to log who is accessing it.

The guest is then able to access the site, though the server will usually severely restrict the access rights of guests on the system. Many FTP servers support both identified and anonymous access, with authorized users having more permissions (such as being able to traverse the full directory path, and having the right to delete or rename files) while anonymous ones may only be able to read files from a particular directory set up for public access.



Key Concept: Many FTP servers support *anonymous FTP*, which allows a guest who has no account on the server to have limited access to server resources. This is often used by organizations that wish to make files available to the public for purposes such as technical support, customer support, or distribution.

FTP Data Connection Management, Normal (Active) and Passive Data Connections and Port Usage

The control channel created between the Server-PI and the User-PI using the [FTP connection establishment and authentication process](#) is maintained throughout the FTP session. Commands and replies are exchanged between the protocol interpreters over this channel, but not data.

Each time files or other data need to be sent between the server and user FTP processes, a [data connection](#) must be created. The data connection links the User-DTP with the Server-DTP. This connection is required both for explicit file transfer actions (getting or receiving a file) and also for implicit data transfers, such as requesting a list of files from a directory on the server.

The FTP standard specifies two different ways of creating a data connection, though it doesn't really explain them in a way that is very easy to understand. That's my job. The two methods differ primarily in which device, the client or the server, initiates the connection. This may at first seem like a trivial matter, but as we'll see shortly, it is actually quite important.

Normal (Active) Data Connections

The first method is sometimes called creating a *normal* data connection (because it is the default method) and sometimes an *active* data connection (to contrast it to the passive method we will see in a moment). In this type of connection, the Server-DTP initiates the data channel by opening a TCP connection to the User-DTP. The server uses the special reserved port number 20 (one less than the well-known control FTP port number, 21) for the data connection. On the client machine, the default port number used is the same as the ephemeral port number used for the control connection, but as we'll see shortly, the client will often choose a different port for each transfer.

Let's take an example to see how this works. Suppose the User-PI established a control connection from its ephemeral port number 1678 to the server's FTP control port of 21. Then, to create a data connection for data transfer, the Server-PI would instruct the Server-DTP to initiate a TCP connection from the server's port 20 to the client's port 1678. The client would acknowledge this and then data could be transferred (in either direction — remember that TCP is bidirectional).

In practice, having the client's control and data connection on the same port is not a good idea; it complicates the operation of FTP and can lead to some tricky problems. For this reason, it is strongly recommended that the client specify a different port number using the *PORT* command prior to the data transfer. For example, suppose the client specifies port 1742 using *PORT*. The Server-DTP would then create a connection from its port 20 to the client's port 1742 instead of 1678. This process is shown in [Figure 290](#).

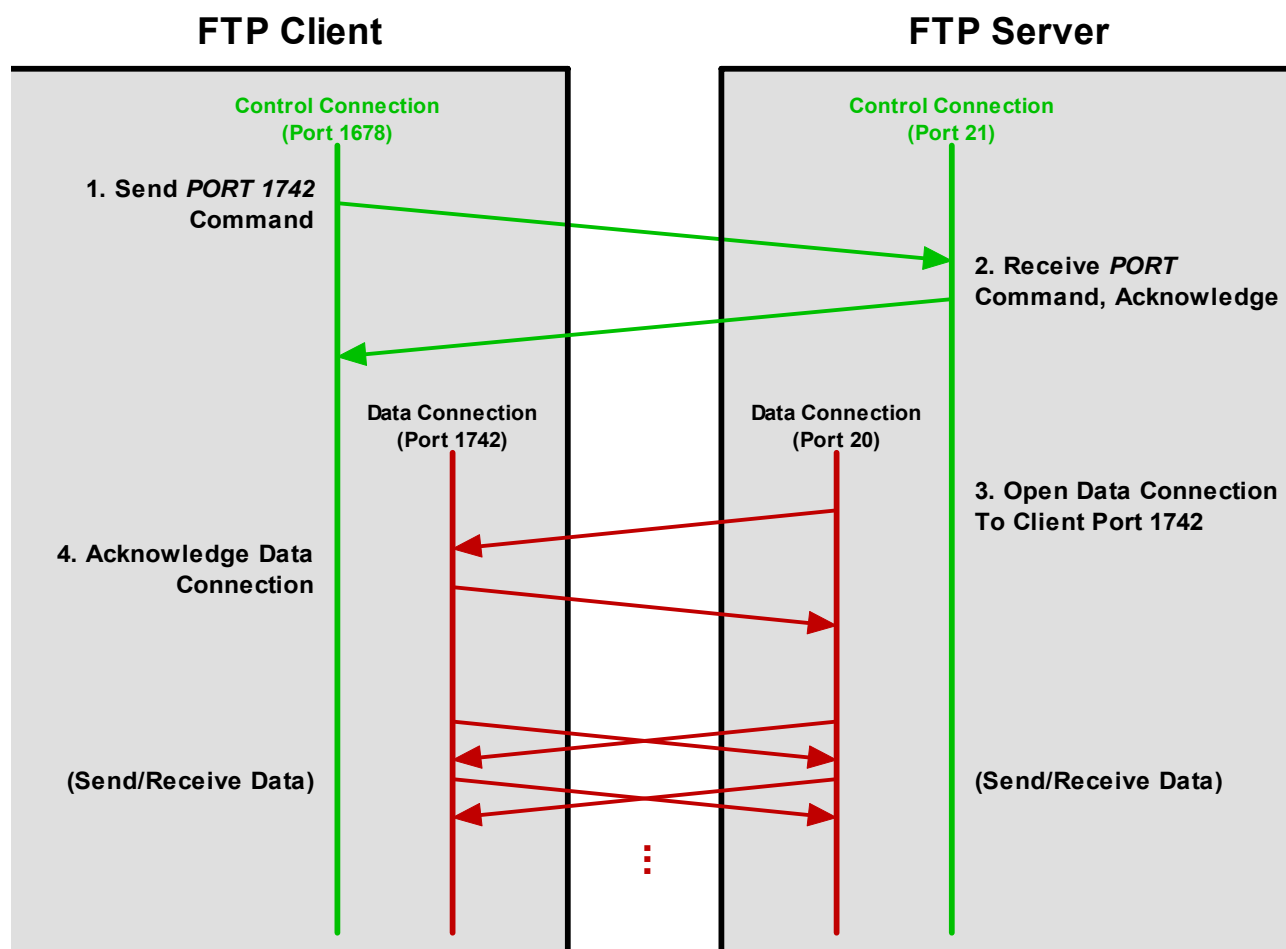

Figure 290: FTP Active Data Connection

In a conventional, or active, FTP data connection, the server initiates the transfer of data by opening the data connection to the client. In this case, the client first sends a *PORT* command to tell the server to use port 1742. The server then opens the data connection from its default port number of 20 to client port 1742. Data is then exchanged between the devices using these ports. Contrast to [Figure 291](#).

Passive Data Connections

The second method is called a *passive* data connection. The client tells the server to be “passive”, that is, to accept an incoming data connection initiated by the client. The server replies back giving the client the server IP address and port number that it should use. The Server-DTP then listens on this port for an incoming TCP connection from the User-DTP. By default, the user machine uses the same port number it used for the control connection, as in the active case. However, here again, the client can choose to use a different port number for the data connection if necessary (typically an ephemeral port number.)

Let's consider our example again, with the control connection from port 1678 on the client to port 21 on the server, but this time consider data transfer using a passive connection, as illustrated in [Figure 291](#). The client would issue the *PASV* command to tell the server it wanted to use passive data control. The Server-DTP would reply back with a port number for

the client to use, say port 2223. The Server-PI would then instruct the Server-DTP to listen on this port 2223. The User-PI would instruct the User-DTP to create a connection from client port 1742 to server port 2223. The server would acknowledge this and then data could be sent and received, again in either direction.

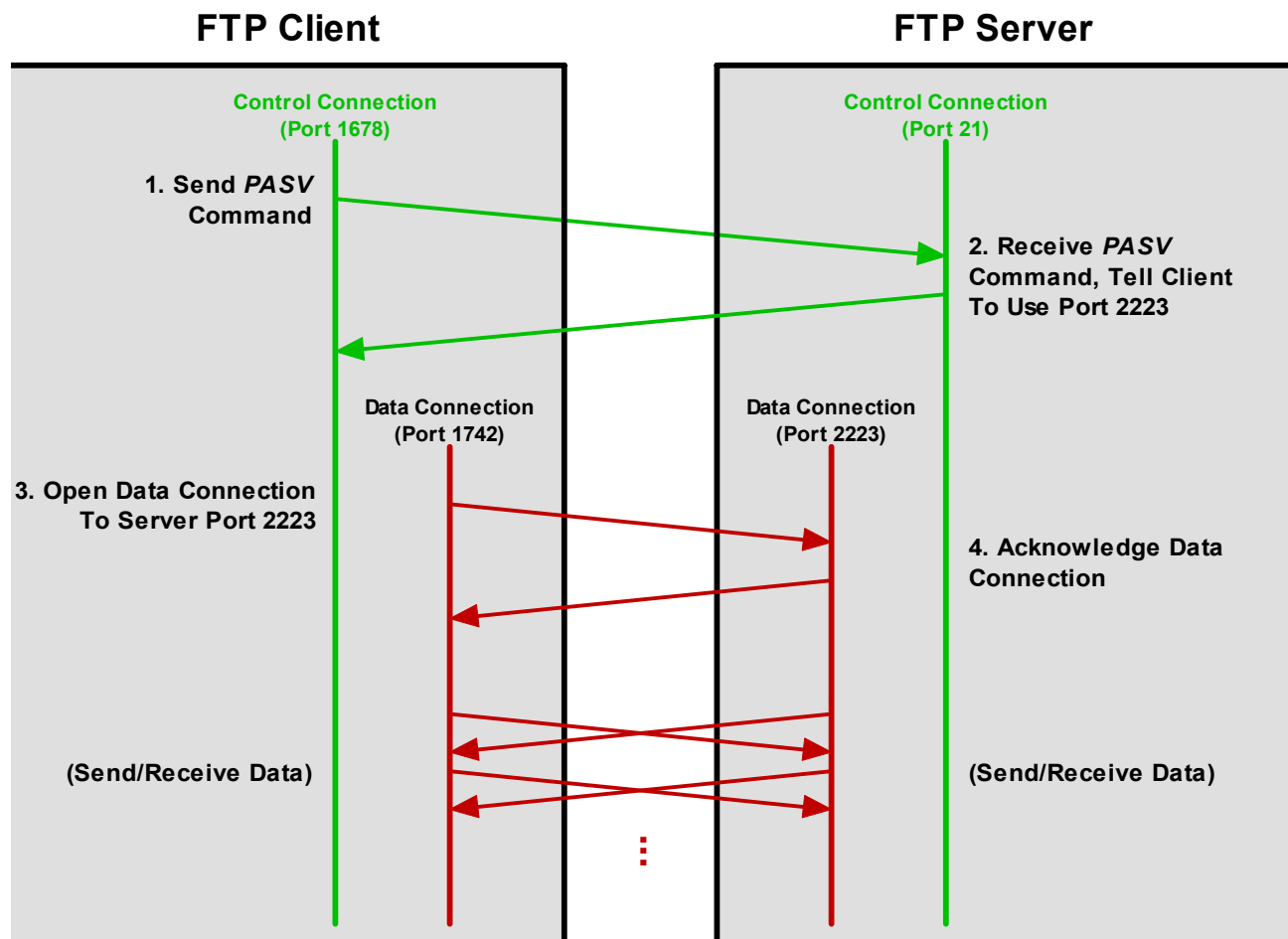

Figure 291: FTP Passive Data Connection

In a passive FTP data connection, the client uses the *PASV* command to tell the server to wait for the client to establish the data connection. The server responds, telling the client what port it should use on the server for the data transmission, in this case port 2223. The client then opens the data connection using that port number on the server and a client port number of its own choosing, in this case 1742. Contrast to [Figure 291](#).

Efficiency and Security Issues In Choosing a Connection Method

This leaves one nagging question, of course: who cares? ☺ I already said that in either case, the data transfer can go in both directions. So what does it matter who initiates the data connection? Isn't this like arguing over who makes a local telephone call?

The answer is related to the dreaded “S word”: *security*. The fact that FTP uses more than one TCP connection can cause problems for the hardware and software that people use to ensure the security of their systems.

Consider what is happening in the case of an active data connection as described in the example above. From the perspective of the client, there's an established control connection from the client's port 1678 to the server's port 21. But the data connection is initiated by the server. So the client sees an incoming connection request to port 1678 (or some other port). Many clients are suspicious about receiving such incoming connections, since under normal circumstances clients establish connections, they don't respond to them. Since incoming TCP connections can potentially be a security risk, many clients are configured to block them using firewall hardware or software.

Why not just make it so the client always accepts connections to the port number one above the ephemeral number used for the control connection? The problem here is that clients often use different port numbers for each transfer by using the *PORT* command. And why is this done? Because of the rules of TCP. As I describe in [the section on TCP](#), after a connection is closed, [a period of time must elapse before the port can be used again](#), to prevent mixing up consecutive sessions. This would cause delays when sending multiple files one after the other, so to avoid this, clients usually use different port numbers for each transfer. This is more efficient, but means a firewall protecting the client would be asked to accept incoming connections that appear to be going to many unpredictable port numbers.

The use of passive connections largely eliminates this problem. Most firewalls have a lot more difficulty dealing with incoming connections to odd ports than outgoing connections. RFC 1579, *Firewall-Friendly FTP*, discusses this issue in detail. It recommends that clients use passive data connections by default instead of using normal connections with the *PORT* command, to avoid the port-blocking problem.

Of course, passive data connections don't really eliminate the problem, they just push it off onto servers. These servers now must face the issue of incoming connections to various ports. Still, it is, generally speaking, easier to deal with security issues on a relatively smaller number of servers than a large number of clients. FTP servers must be able to accept passive mode transfers from clients anyway, so the usual approach is to set aside a block of ports for this purpose, which the server's security provisions allow to accept incoming connections, while blocking incoming connection requests on other ports.



Note: As an aside, it is that it is a significant violation of the [layering principle of networks](#) to pass IP addresses and port numbers in FTP commands such as *PORT* and *PASV* and the replies to them. This isn't just a philosophical issue: applications aren't supposed to deal with port numbers, and this creates issues when certain lower-layer technologies are used. For example, consider the use of [Network Address Translation](#), which modifies IP addresses and possibly port numbers. In order to prevent NAT from "breaking" when FTP is used, [special provision](#) must be made to handle the protocol.



Key Concept: FTP supports two different models for establishing data connections between the client and server. In *normal*, or *active* data connections, the server initiates the connection when the client requests a transfer, and the client responds; in a *passive* data connection, the client tells the server it will initiate the connection, and the server responds. Since TCP is bidirectional, data can flow either way in both cases; the chief difference between the two modes has to do with security. In particular, passive mode is often used because many client devices today are not able to accept incoming connections from servers.

FTP General Data Communication and Transmission Modes

Once a [data connection](#) has been established between the Server-DTP and the User-DTP, data is sent directly from the client to the server, or the server to the client, depending on the specific command issued. Since control information is sent using the distinct control channel, the entire data channel can be used for data communication. (Of course, these two logical channels are combined at lower layers along with all other TCP and UDP connections on both devices, so it's not like this represents a performance improvement over a single channel. Just wanted to make that clear.)

FTP defines three different *transmission modes* (also called *transfer modes*) that specify exactly how data is sent from one device to another over an opened data channel: stream mode, block mode, and compressed mode.

Stream Mode

In this mode, data is sent simply as a continuous stream of unstructured bytes. The sending device simply starts pushing data across the TCP data connection to the recipient. No message format with distinct header fields is used, making this method quite different from the way many other protocols send information in discrete chunks. It relies strongly on the [data streaming](#) and [reliable transport services](#) of TCP. Since there is no header structure, the end of the file is indicated simply by the sending device closing the data connection when it is done.

Of the three methods, stream mode is the one that is by far the most widely used in real FTP implementations. There are likely three reasons for this. First, it is the default and also the simplest method, so it is the easiest to implement and one that is required for compatibility. Second, it is the most general, because it treats all files as simple streams of byte without paying attention to their content. Third, it is the most efficient method because no bytes are wasted on “overhead” such as headers.

Block Mode

This is a more “conventional” data transmission mode in which data is broken into data blocks and encapsulated into individual FTP blocks, or records. Each record has a three-byte header that indicates its length and contains information about the data blocks being sent. A special algorithm is used to keep track of the transmitted data and to detect and restart an interrupted transfer.

Compressed Mode

A transmission mode where a relatively simple compression technique called *run-length encoding* is used to detect repeated patterns in the data being sent, and then represent them in such a way that the overall message takes fewer bytes. The compressed information is then sent in a way similar to block mode, using a header+payload record format.

Compressed mode seems on the surface to be useful. In practice, however, compression is often implemented in other places in a typical networking software stack, making it unnecessary in FTP. For example, if you are transferring a file over the Internet using an analog modem, your modem normally performs compression down at layer one. Large files on FTP servers are also often already compressed using something like the ZIP format, meaning further compression would serve no purpose.



Key Concept: FTP includes three different transmission modes: *stream*, *block* and *compressed*. In stream mode, data is sent as a continuous sequence of bytes; in block mode, data is formatted into blocks with headers; and in compressed mode, bytes are compacted using run-length encoding. Stream mode is the one most commonly used.

FTP Data Representation: Data Types, Data Structures and Format Control

The most general way of designing the File Transfer Protocol would have been to make it treat all files as “black boxes”. The file would be represented as just as a set of bytes. FTP would pay no attention to what the file contained, and would simply move the file, one byte at a time, from one place to another. In this, it would seem to be very similar to the “copy” command that is implemented on most file systems, which likewise creates a copy without looking into the file to see what it contains.

So what would be the problem with that, you may wonder? Well, for some types of files, this is exactly what we want, but for others, it introduces a problem. The reason is that certain types of files use different representations on different systems. If you copy a file from one place to another on the same computer using a “copy” command, there is no problem: the same representation for files is used everywhere within that computer. But when you copy it to a computer that uses a different representation, however, you may encounter difficulties.

The most common example of this is a type of file that may surprise you: simple text files. All ASCII text files use the ASCII character set, but they differ in the control characters used to mark the end of a line of text. On UNIX, a line feed (LF) character is used; on Apple computers, a carriage return (CR); and Windows machines used both (CR+LF).

If you move a text file from one type of system to another using regular FTP, the data will all get moved exactly as it was. Moving a text file from a UNIX system to a PC as just a set of bytes would mean programs would not properly recognize end of line markers. Avoiding this predicament requires that FTP move past the idea that “all files are just bytes” and incorporate some intelligence to handle different types of files. The FTP standard recognizes this by allowing the specification of certain details about the file's internal representation prior to transfer.

FTP Data Types

The first piece of information that can be given about a file is its *data type*, which dictates the overall representation of the file. There are four different data types specified in the FTP standard:

- ☉ **ASCII:** Defines an ASCII text file, with lines marked by some sort of end-of-line marker as described above.
- ☉ **EBCDIC:** Conceptually the same as the ASCII type, but for files using IBM's EBCDIC character set.
- ☉ **Image:** The file has no formal internal structure and is sent one byte at a time without any processing; this is the “black box” mode I mentioned above.
- ☉ **Local:** This data type is used to handle files that may store data in logical bytes containing a number of bits other than 8. Specifying this type along with the way the data is structured allows the data to be stored on the destination system in a manner consistent with its local representation.



Note: The term “byte” conventionally refers to 8 bits but strictly speaking, the term for 8 bits is “octet”. A byte may in fact contain a number of bits other than 8 on certain systems. [See the background topic on bits and bytes for the details.](#)

In practice, the two data types most often used are *ASCII* and *image*. The *ASCII* type is used for text files, and allows them to be moved between systems with line-end codes converted automatically. The *Image* type is used for generic binary files, such as graphical images, ZIP files and other data that is represented in a universal manner. It is also often called the *binary* type for that reason.

ASCII Data Type Line Delimiting Issues

When the *ASCII* data type is used, differences in internal representations between systems are handled by using a universal external representation that acts as a “common language”. Lines of the file being transmitted are converted by the sending FTP process from the

sender's internal representation to the neutral ASCII representation used by the [Telnet](#) protocol ("NETASCII") with each line ending in "CR+LF". The receiving device then converts from this neutral representation to the internal format used by the recipient file system.

For example, when using FTP to move a text file from a Macintosh to a UNIX system, each line would have the "CR" changed to a "CR+LF" for transmission over the FTP data channel. The receiving UNIX system would change each "CR+LF" to just "LF", so UNIX programs would read it properly.

Note that this actually does mean the resulting file can be bigger or smaller than the original, if it is transferred between systems using *ASCII* mode. Also, since FTP works by converting to a neutral representation for universality, sending an ASCII file from a UNIX system to a UNIX system means each "LF" is changed to "CR+LF" for transmission, then changed back to just "LF" by the recipient. Slightly inefficient, but not that big a deal.

It's very important that when FTP is used, the correct data type be specified with the appropriate user command. Sending a text file between dissimilar systems without setting *ASCII* mode will result in either a file that cannot be properly read on the destination, or one that has stray characters in it. Conversely, binary files *must* be sent in binary mode. If you send something like a ZIP file or a JPG graphic in *ASCII* mode, the FTP software will think it is a text file. It will treat the file as if it were text, and each time it encounters bytes in the file that look like "CR", "LF" or "CR+LF" it will convert them, which you do not want. (Having the wrong data type set is a leading cause of corrupted files when using FTP to move files between PCs and UNIX systems. I know from experience!)



Key Concept: FTP defines four data types: *ASCII*, *EBCDIC*, *image* and *local*. *ASCII* and *EBCDIC* are used for text files in the ASCII and EBCDIC character sets, respectively; the *image* type is used for files with no specific structure, and the *local* type for local representation. The *ASCII* type is important because it allows text files to be transferred successfully between file systems that may use different methods of indicating the end of a line of text. The *image* type, also called *binary*, is used for files that must be sent and received byte-for-byte with no transformation, such as executable files, graphics and files with arbitrary formats.

FTP Format Control

For the ASCII and EBCDIC types, FTP defines an optional parameter called *format control*. This allows a user to specify a particular representation for how vertical formatting is used to describe a file. The three options are:

- ☉ **Non Print:** The default, indicating no vertical formatting.
- ☉ **Telnet Format:** Indicates that vertical format control characters, as specified in the Telnet protocol, are used in this file.
- ☉ **Carriage Control / FORTRAN:** The file uses format control characters given as the first character of each line, as specified for the FORTRAN programming language.

The format control option was created for the particular purpose of properly handling files transferred from host devices to printers. It is not used today, to my knowledge (or if it is used, it is only in special applications.)

FTP Data Structures

In addition to specifying a file's data type, it is also possible to specify the file's *data structure*. There are three possibilities:

- ☉ **File Structure:** The file is a contiguous stream of bytes with no internal structure.
- ☉ **Record Structure:** The file consists of a set of sequential records, each of which is delimited by an end-of-record marker.
- ☉ **Page Structure:** The file contains a set of special indexed data pages.

The *file* structure is the default and is used for most types of files. The *record* structure can be used for ASCII text files, but these are more commonly sent with the regular *file* structure using the *ASCII* data type. The *page* structure is not commonly used; I believe it was initially created for a now archaic type of computer used in the early ARPAnet.



FTP Commands and Replies

In [the previous section](#) I discussed the general operation of the File Transfer Protocol. As part of this description I explained how data transfers are performed, how connections are established and managed, and the various transmission modes and data types that FTP supports. All of these functions are implemented using a special set of *FTP commands* sent [by the User-FTP process to the Server-FTP process](#). The server device acknowledges commands by sending back *replies* using special codes. Understanding FTP commands and reply codes will allow us to see fully how the protocol works.

I begin the section by discussing FTP commands and how they are grouped. I then show the special encoding format used for FTP reply codes, and list some of the more common and important codes. I also discuss the FTP user interface and the commands used by typical FTP implementations to allow a user to communicate with the FTP software. These commands are usually different than the internal FTP commands, to allow the user to operate the protocol in a way more friendly to humans.

FTP Internal Protocol Commands and Command Groups

An FTP session begins with the establishment of a TCP connection from an FTP client (user device) to an FTP server. Once established, the [control channel](#) is logically in place between the Server-PI and the User-PI. All communication to manage the operation of the protocol takes place over this channel. The User-PI sends *protocol commands* to the Server-PI, which processes them and takes appropriate action. The Server-PI responds back with *reply codes* to tell the User-PI the result of the commands it issued and convey other important information.

FTP Command Groups

Each command is identified by a short three-letter or four-letter *command code* for convenience, and performs a specific task in the overall functionality of FTP. There are several dozen of these protocol commands, and to help organize them, the FTP standard categorizes them into three groups, based on overall function type:

- ① **Access Control Commands:** Commands that are part of the [user login and authentication process](#), are used for resource access, or are part of general session control.
- ② **Transfer Parameter Commands:** Commands that specify parameters for how data transfers should occur. For example, commands in this group specify the [data type](#) of a file to be sent, indicate whether [passive or active data connections](#) will be used, and so forth.
- ③ **FTP Service Commands:** This is the largest group, containing all the commands that actually perform file operations, such as sending and receiving files. Commands to implement support functions, such as deleting or renaming files, are also here.

Interestingly, the actual transmission of FTP commands over the control channel is done using specifications based on the [Telnet protocol](#). You may recall from the [FTP overview](#) that Telnet and FTP are two of the very oldest TCP/IP applications, the former being for

“direct” network use and the latter for “indirect” resource access. They were developed at around the same time, and setting up the FTP control channel to act as a type of Telnet connection is a good example of how Internet standards try not to “reinvent the wheel”.



Key Concept: FTP operation is controlled through the issuing of *protocol commands* from the FTP client to the FTP server. Each command has a three- or four-letter command code that indicates its function. The commands are organized into three groups: *access control commands* used for login and general session control; *transfer parameter commands* that control how transfers are performed; and *FTP service commands*, which are used to perform actual file operations.

FTP Protocol Commands

Since the commands are based on the Telnet specifications, they are just sent as plain text as specified by Telnet's [Network Virtual Terminal \(NVT\)](#) conventions. I have provided below three tables that describe the FTP internal protocol commands in the order that they appear in the FTP standard (RFC 959). [Table 226](#) covers FTP access control commands, [Table 227](#) lists transfer parameter commands, and [Table 228](#) service commands.

Table 226: FTP Access Control Commands (Page 1 of 2)

Command Code	Command	Description
<i>USER</i>	<i>User Name</i>	Identifies the user attempting to establish an FTP session.
<i>PASS</i>	<i>Password</i>	Specifies the password for the user given previously by the <i>USER</i> command during login authentication.
<i>ACCT</i>	<i>Account</i>	Specifies an account for an authenticated user during the FTP session. Only used on systems that require this to be separately identified; most select an account automatically based on the name entered in the <i>USER</i> command.
<i>CWD</i>	<i>Change Working Directory</i>	Allows the user to specify a different directory for file transfer during an FTP session.
<i>CDUP</i>	<i>Change To Parent Directory (“Change Directory Up”)</i>	A special case of the <i>CWD</i> command that goes to the directory one level up in the server's directory structure. It is implemented separately to abstract out differences in directory structures between file systems; the user can just use <i>CDUP</i> instead of knowing the specific syntax for navigating up the directory tree on the server.
<i>SMNT</i>	<i>Structure Mount</i>	Allows the user to mount a particular file system for access to different resources.

Table 226: FTP Access Control Commands (Page 2 of 2)

Command Code	Command	Description
REIN	<i>Reinitialize</i>	Reinitializes the FTP session, flushing all set parameters and user information. This returns the session to the state when the control connection is just established. It is, in essence, the opposite of the <i>USER</i> command. The next command issued is often <i>USER</i> , to log in a different user.
QUIT	<i>Logout</i>	Terminates the FTP session and closes the control connection. Note that the naming of this command “Logout” was unfortunate; the <i>REIN</i> command is really most similar to a conventional “logout” command, as it terminates a logged-in user and allows another user to log in. In contrast, the <i>QUIT</i> command shuts down the entire session.

Table 227: FTP Transfer Parameter Commands

Command Code	Command	Description
PORT	<i>Data Port</i>	Used to tell the FTP server that the client wants to accept an active data connection on a specific port number.
PASV	<i>Passive</i>	Requests that the FTP server allow the User-DTP to initiate passive data connections.
TYPE	<i>Representation Type</i>	Specifies for the file to be transferred the data type (ASCII, EBCDIC, Image or Local), and optionally the format control (Non Print, Telnet or Carriage Control).
STRU	<i>File Structure</i>	Specifies the data structure for the file (File, Record or Page).
MODE	<i>Transfer Mode</i>	Specifies the transmission mode to be used (Stream, Block or Compressed).

Table 228: FTP Service Commands (Page 1 of 2)

Command Code	Command	Description
RETR	<i>Retrieve</i>	Tells the server to send the user a file.
STOR	<i>Store</i>	Sends a file to the server.
STOU	<i>Store Unique</i>	Like <i>STOR</i> , but instructs the server to make sure the file has a unique name in the current directory. This is used to prevent overwriting a file that may already exist with the same name. The server replies back with the name used for the file.
APPE	<i>Append (with Create)</i>	Like <i>STOR</i> , but if a file with the name specified already exists, the data being sent is appended to it instead of replacing it.
ALLO	<i>Allocate</i>	An optional command used to reserve storage on the server before a file is sent.
REST	<i>Restart</i>	Restarts a file transfer at a particular server marker. Used only for <i>Block</i> or <i>Compressed</i> transfer modes.

Table 228: FTP Service Commands (Page 2 of 2)

Command Code	Command	Description
RNFR	<i>Rename From</i>	Specifies the old name of a file to be renamed. See the <i>RNTO</i> command just below.
RNTO	<i>Rename To</i>	Specifies the new name of a file to be renamed. Used with the <i>RNFR</i> command.
ABOR	<i>Abort</i>	Tells the server to abort the last FTP command and/or the current data transfer.
DELE	<i>Delete</i>	Deletes a specified file on the server.
RMD	<i>Remove Directory</i>	Deletes a directory on the server.
MKD	<i>Make Directory</i>	Creates a directory.
PWD	<i>Print Working Directory</i>	Displays the current server working directory for the FTP session; shows the user "where they are" in the server's file system.
LIST	<i>List</i>	Requests a list of the contents of the current directory from the server, including both names and other information. Similar in concept to the "DIR" command in DOS/Windows or the "ls" command in UNIX.
NLST	<i>Name List</i>	Like <i>LIST</i> , but returns only the names in a directory.
SITE	<i>Site Parameters</i>	Used to implement site-specific functions.
SYST	<i>System</i>	Requests that the server send to the client information about the server's operating system.
STAT	<i>Status</i>	Prompts the server to send an indication of the status of a file or the transfer currently in progress.
HELP	<i>Help</i>	Asks the server for any help information that might be useful in allowing the user to determine how the server should be used.
NOOP	<i>No Operation</i>	Does nothing, other than prompting the server to send an "OK" response to verify that the control channel is alive.



Note: FTP commands are not case-sensitive, but have been shown in upper case for clarity.

FTP commands are all sent between FTP protocol elements; they are not usually issued directly by users. Instead, a special set of [user commands](#) is employed for this purpose. The FTP user interface implements the link between the user and the User-FTP process, including the translation of user commands into FTP protocol commands.

FTP Replies, Reply Code Format and Important Reply Codes

Each time that the User-PI sends a command to the Server-PI over the control connection, the server sends back a *reply*. FTP replies serve three main purposes. First, they serve as confirmation that the server received a command. Second, they tell the user device whether the command was accepted or not, and if an error occurred, what it was. Third, they communicate various types of information to the user of the session, such as the status of a transfer.

The Advantages of Using Both Text and Numeric Replies

For a human user, a string of reply text would be sufficient to satisfy the requirements above, and FTP replies do include descriptive text. But having only a text string would make it difficult or impossible for FTP software on the client side to interpret results coming from the server. FTP was designed to also allow software applications to interact with each other over the FTP command link. For this reason, the protocol designed its reply system around the use of *reply codes*.

FTP reply codes are three-digit numeric responses that can be easily interpreted by a computer program. They are also useful for human users who are familiar with FTP, because they communicate at a glance the results of various operations. While each FTP server implementation may differ in the text sent for each type of reply, the reply codes are used in a consistent manner based on the specifications of the FTP standard. It is therefore the codes that are examined to determine the results of a command; the text is just descriptive.

Reply Code Structure and Digit Interpretation

To make reply codes even more useful, the codes are not just assigned in a linear or random order, but a special encoding scheme is used. Each code has three digits that each communicate a particular type of information and to categorize replies. A code can be considered to be of the form “xyz”, where “x” is the first digit, “y” the second and “z” the third.



Key Concept: Each command sent by the FTP client results in a reply sent by the FTP server. FTP replies consist of a three-digit numeric *reply code*, along with a line of descriptive text. The reply code serves to standardize FTP replies, both so they can be interpreted by client software, and so experienced users can see at a glance what the results were of a command. The reply code is structured so that the first two digits indicate the type of reply and to what category it belongs.

First Reply Code Digit (“x”)

The first digit of the reply code indicates the success or failure of the command in general terms, whether a successful command is complete or incomplete, and whether an unsuccessful one should be tried again or not. [Table 229](#) shows the possible values.

Table 229: FTP Reply Code Format: First Digit Interpretation

Reply Code Format	Meaning	Description
1yz	Positive Preliminary Reply	An initial response indicating that the command has been accepted and processing of it is still in progress. The user should expect another reply before a new command may be sent.
2yz	Positive Completion Reply	The command has been successfully processed and completed.
3yz	Positive Intermediate Reply	The command was accepted, but processing of it has been delayed, pending receipt of additional information. This type of reply is used in the middle of command sequences. For example, it is used as part of the authentication sequence after receiving a <i>USER</i> command but before the matching <i>PASS</i> command is sent.
4yz	Transient Negative Completion Reply	The command was not accepted and no action was taken, but the error is temporary and the command may be tried again. This is used for errors that may be a result of temporary glitches or conditions that may change; for example, a file being “busy” due to another resource accessing it at the time a request was made for it.
5yz	Permanent Negative Completion Reply	The command was not accepted and no action was taken. Trying the same command again is likely to result in another error. For example, a request for a file that is not found on the server would fall into this category, or sending an invalid command like “BUGU”. ☺

Second Reply Code Digit (“y”)

The second digit is used to categorize messages into functional groups. These groups are shown in [Table 230](#).

Table 230: FTP Reply Code Format: Second Digit Interpretation (Page 1 of 2)

Reply Code Format	Meaning	Description
x0z	Syntax	Syntax errors or miscellaneous messages.
x1z	Information	Replies to requests for information, such as status requests.
x2z	Connections	Replies related to the control connection or data connection.
x3z	Authentication and Accounting	Replies related to login procedures and accounting.

Table 230: FTP Reply Code Format: Second Digit Interpretation (Page 2 of 2)

Reply Code Format	Meaning	Description
x4z	Unspecified	Not defined.
x5z	File System	Replies related to the server's file system.

Third Reply Code Digit (“z”)

The last reply code digit indicates a specific type of message within each of the functional groups described by the second digit. The third digit allows each functional group to have 10 different reply codes for each reply type given by the first code digit (preliminary success, transient failure and so on.)

Combining Digit Values to Make Specific Reply Codes

These “x”, “y” and “z” digit meanings are combined to make specific reply codes. For example, consider reply code “530”, diagrammed in [Figure 292](#). The first digit tells you that this is a permanent negative reply; the second indicates that it is related to login or accounting. (It is in fact an error message received when a login fails.)

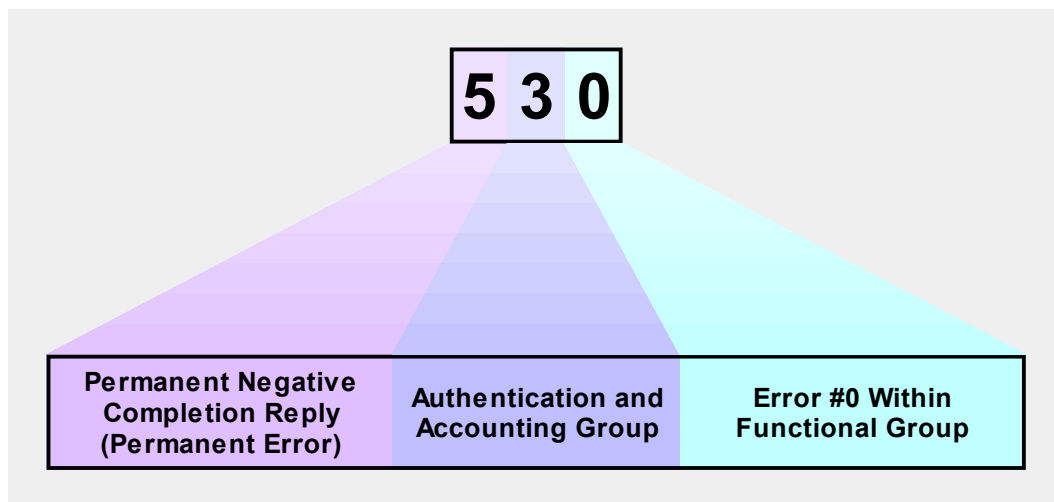

Figure 292: FTP Reply Code Format

This diagram shows how the three-digit FTP reply code format is interpreted. In this example, reply code 530, the “5” indicates a permanent error, the “3” specifies that the error is related to authentication or accounting, and the “0” is the specific error type. A similar method is used for reply codes in many other TCP/IP application protocols, including SMTP and HTTP.

Using “encoded” reply codes allows the code itself to immediately communicate information, and provides a way of keeping different types of responses organized. The idea described above was adapted for use by several other application protocols, including SMTP for e-mail, NNTP for network news and HTTP for the World Wide Web.

Common FTP Reply Codes

Table 231 contains a list of some of the more common FTP reply codes taken from RFC 959. They are shown in numerical order, along with the reply text given as typical in that document, and additional descriptive information from myself where needed:

Table 231: FTP Reply Codes (Page 1 of 2)

Reply Code	Typical Reply Text	Description
110	Restart marker reply.	Used as part of the marker restart feature when transferring in block mode.
120	Service ready in "nnn" minutes.	"nnn" indicates the number of minutes until the service will be available.
125	Data connection already open; transfer starting.	
150	File status okay; about to open data connection.	
200	Command okay.	Sometimes the text indicates the name of the command that was successful.
202	Command not implemented, or superfluous at this site.	
211	System status, or system help reply.	Will contain system-specific status or help information.
212	Directory status.	
213	File status.	
214	Help message.	Includes help information of use to a human user of this server.
215	"NAME" system type.	"NAME" is the name of a type of operating system. Often sent as a reply to the SYST command.
220	Service ready for new user.	Sent when the command channel is established before the USER command is sent.
221	Service closing control connection.	A "goodbye" message sent when the session is closed.
225	Data connection open; no transfer in progress.	
226	Closing data connection.	Sent after a successful file transfer or a file abort.
227	Entering Passive Mode (h1,h2,h3,h4,p1,p2).	Sent in reply to the PASV command, indicates the IP address and port to use for the data connection.
230	User logged in, proceed.	Sent after successful USER and PASS authentication. Systems often include additional "greeting" or other information with this code after a login.
250	Requested file action okay, completed.	The text description will provide more details about what was successfully done, such as confirming a change of directory or deleted file.

Table 231: FTP Reply Codes (Page 2 of 2)

Reply Code	Typical Reply Text	Description
257	"PATHNAME" created.	"PATHNAME" is replaced by the path created.
331	User name okay, need password.	Intermediate result after sending <i>USER</i> but before sending <i>PASS</i> .
332	Need account for login.	
350	Requested file action pending further information.	
421	Service not available, closing control connection.	Sometimes sent if the FTP server is in the process of shutting down.
425	Can't open data connection.	
426	Connection closed; transfer aborted.	
450	Requested file action not taken. File unavailable.	The file is not available; for example, it may be locked by another user. Contrast to reply code 550.
451	Requested action aborted: local error in processing.	
452	Requested action not taken. Insufficient storage space in system.	The file system is full.
500	Syntax error, command unrecognized.	Bad or excessively long command line was sent.
501	Syntax error in parameters or arguments.	
502	Command not implemented.	
503	Bad sequence of commands.	
504	Command not implemented for that parameter.	
530	Not logged in.	Sent if authentication fails due to a bad user name or incorrect password.
550	Requested action not taken. File unavailable.	File was not found or user does not have access to it. This error code may be sent in reply to any file transfer command if the user has not successfully logged in yet. Contrast to reply code 450.
551	Requested action aborted: page type unknown.	
552	Requested file action aborted. Exceeded storage allocation.	
553	Requested action not taken. File name not allowed.	

FTP Multiple-Line Text Replies

It is possible for a reply to contain more than one line of text. In this case, each line starts with the reply code, and all lines but the last have a hyphen between the reply code and the reply text, to indicate that the reply continues. The last line has a space between the reply code and reply text, just like a single-line reply. This facility is often used to provide additional response information after a user logs in, via the 230 reply code. [Table 232](#) contains an example.

Table 232: FTP Multiple-Line Text Reply Example

```
230-Welcome user to FTP server jabberwockynocky.  
230-  
230-You are user #17 of 100 simultaneous users allowed.  
230-  
230-  
230-Please see the file "faq.txt" for help using this server.  
230-  
230 Logged in.
```

As mentioned before, the actual text string for each reply code is implementation-specific. You can sometimes find some rather humorous text strings associated with some of these error messages. For example, I tried some commands using the FreeBSD FTP client on one of my Internet accounts. If you try to send or receive a file before you are logged in, it doesn't return an error like "Requested action not taken. File unavailable". It tells me "Login first, then I might let you do that.". Laugh... what an attitude these computers have today! 😊

FTP User Interface and User Commands

The FTP [protocol command set](#) provides a rich, complete set of instructions for implementing the File Transfer Protocol. A human user could employ those commands to perform file transfer functions directly with an FTP server. But to do this requires that the user have an intimate knowledge of how FTP works. The user must know exactly which commands to send at which time, and in what order.

FTP User Interface Benefits

Memorizing internal FTP commands might be a reasonable assignment for an internet-working expert, but not for a typical TCP/IP application user. For this reason, the FTP protocol defines an additional [protocol component](#) as part of the User-FTP Process: the *FTP user interface*. It provides three main benefits to the FTP user:

- ☉ **User Friendliness:** The FTP user interface presents FTP to the human user in a way that is easier and simpler to use than issuing protocol commands. Instead of requiring the knowledge of all those four-letter codes, the user interface can allow functions to be performed with more intuitive human-language commands. For example, we can say "get" a file instead of knowing to use the command *RETR*.

-
- **Customization:** The command used to perform a particular function can be customized based on common parlance in the networking industry, without requiring changes to be made to the FTP protocol itself. For example, the “image” transfer mode is now also commonly called “binary” mode, so a user command called “binary” has been created to set this mode.
 - **Detail Abstraction and Command Sequence Simplification:** A single user command can be made to issue multiple FTP protocol commands, hiding internal FTP details and making the protocol easier to use. In particular, commands that are related to the maintenance of the connection and other “overhead” issues that users don’t want to deal with can be automated. For example, an FTP client normally issues a *PASV* or *PORT* command prior to each data transfer. The user interface can take care of issuing this command automatically prior to a *RETR* or *STOR* command when a user tells FTP to get or send a file.

Command-Line and Graphical FTP Interfaces

Traditionally, FTP clients have used a *command-line interface*. In this familiar arrangement, an FTP client is invoked and the user is automatically asked for a user name and password to establish an FTP session. Then, the user is presented with a command prompt, at which they can type various FTP commands to perform different functions. Text responses from the server are displayed to the user to indicate the results of various commands. Normally, the internal protocol commands (such as *PASV* and *STOR*) sent by the client are suppressed to avoid “screen clutter” but can be enabled in a debug mode.

Command-line utilities are efficient but some folks don’t care for them. They are rather “old school” in the context of modern graphical operating systems and applications. Thus, there are also now many FTP clients that are graphical in nature. They allow actions to be performed arguably even more quickly, by clicking on buttons instead of typing commands. Some allow files to be transferred by “dragging and dropping” from a local file system display to one on a remote server. These make FTP even easier to use.



Key Concept: The *FTP user interface* is the component on the FTP client that acts as an intermediary between the human user and the FTP software. The existence of the user interface allows FTP to be used in a friendly manner without requiring knowledge of FTP’s internal protocol commands. Most FTP software uses either a *command-line interface* that understands English-like *user commands*, or a *graphical interface*, where mouse clicks and other graphical operations are translated into FTP commands.

Typical FTP User Commands

To discover the specific commands supported by an FTP client, consult its documentation. In a command-line client, you can enter the command “?” to get a list of supported commands. [Table 233](#) shows some of the common commands encountered in typical FTP command-line clients, along with the typical parameters they require.

Table 233: FTP User Commands (Page 1 of 2)

User Command	Description
account <account-name>	Sends the <i>ACCT</i> command to access a particular account on the server.
append <file-name>	Appends data to a file using <i>APPE</i> .
ascii	Sets the <i>ASCII</i> data type for subsequent transfers.
binary	Sets the <i>Image</i> data type for subsequent transfers. Same as the <i>image</i> command.
bye	Terminates FTP session and exits the FTP client (same as <i>exit</i> and <i>quit</i>).
cd <directory-path>	Change remote server working directory (using <i>CWD</i> protocol command.)
cdup	Go to parent of current working directory.
chmod <file-name>	On UNIX systems, change file permissions of a file.
close	Closes a particular FTP session but user stays at FTP command line.
debug	Sets debug mode.
delete <file-name>	Deletes a file on the FTP server.
dir [<optional-file-specification>]	Lists contents of current working directory (or files matching the specification).
exit	Another synonym for <i>bye</i> and <i>quit</i> .
form <format>	Set transfer format.
ftp <ftp-server>	Open session to FTP server.
get <file-name> [<dest-file-name>]	Get a file. If the “<dest-file-name>” parameter is specified, it is used for the name of the file retrieved; otherwise, the source file name is used.
help [<optional-command-name>]	Displays FTP client help information. Same as “?”.
image	Set Image data type, like the <i>binary</i> command.
ls [<optional-file-specification>]	Lists contents of current working directory (or files matching the specification). Same as <i>dir</i> .
mget <file-specification>	Gets multiple files from the server.
mkdir <directory-name>	Create directory on remote server.
mode <transfer-mode>	Set file transfer mode.
mput <file-specification>	Sends (“puts”) multiple files to the server.
msend <file-specification>	Same as <i>mput</i> .
open <ftp-server>	Open session to FTP server (same as <i>ftp</i>).
passive	Turns passive transfer mode on and off.

Table 233: FTP User Commands (Page 2 of 2)

User Command	Description
put <file-name> [<dest-file-name>]	Sends a file to the server. If the “<dest-file-name>” parameter is specified, it is used as the name for the file on the destination host; otherwise, the source file name is used.
pwd	Prints current working directory.
quit	Terminates FTP session and exits FTP client (same as <i>bye</i> and <i>exit</i> .)
recv <file-name> [<dest-file-name>]	Receives file (same as <i>get</i>). If the “<dest-file-name>” parameter is specified, it is used for the name of the file retrieved; otherwise, the source file name is used.
rename <old-file-name> <new-file-name>	Renames a file.
rhelp	Displays remote help information, obtained using FTP <i>HELP</i> command.
rmdir <directory-name>	Removes a directory.
send <file-name> [<dest-file-name>]	Sends a file (same as <i>put</i>). If the “<dest-file-name>” parameter is specified, it is used as the name for the file on the destination host; otherwise, the source file name is used.
site	Sends a site-specific command to the server.
size <file-name>	Show size of remote file.
status	Displays current session status.
struct <structure-type>	Sets file structure.
system	Shows the server's operating system type.
type <data-type>	Sets data type for transfers.
user <user-name>	Log in to server as a new user. Server will prompt for password.
? [<optional-command-name>]	Displays FTP client help information. Same as <i>help</i> .

Note how many of these commands are actually synonyms, such as *bye*, *exit* and *quit*. Similarly, one can use the command “type ascii” to set the ASCII data type, or just use the *ascii* command. This is all done for the convenience of the user and is one of the benefits of having a flexible user interface that is distinct from the FTP protocol command set.

Finally, an alternative way of using FTP is through the specification of an FTP [Uniform Resource Locator \(URL\)](#). While FTP is at its heart an interactive system, FTP URLs allow simple functions, such as retrieving a single file, to be done quickly and easily. They also allow FTP file references to be integrated with hypertext (World Wide Web) documents. [See the discussion of URL schemes for more on how FTP uses URLs.](#)



FTP Sample User and Internal Command Dialog

The previous two sections have described [how FTP operates](#), and shown the [commands and reply codes](#) used to implement communication between an FTP user and an FTP server. Having now seen all the details of how FTP works, let's tie everything together by looking at a sample FTP session between an FTP client and server, to see FTP commands and replies "in action".

In this example, I will invoke FTP from a client to retrieve a text file from an FTP server, then delete the file from the server and the directory that contained it. In the process, I will issue some additional commands to illustrate more of how FTP works. I will enable "debug" mode in the FTP client so that for each user command we can see the actual FTP protocol commands generated.

[Table 234](#) shows the sample FTP dialog, slightly simplified. The first column contains commands entered by the user (that's me) on the FTP client. The second shows the actual protocol command(s) sent to the FTP server in highlighted text, and the reply returned from the server to the client in plain text. The third contains descriptive comments.

Table 234: Sample FTP Session (Page 1 of 3)

User Command	FTP Protocol Command / FTP Server Reply	Comments
<code>ftp -d pcguide.com</code>	Connected to pcguide.com. 220 ftp199.pair.com NcFTPd Server (licensed copy) ready. Name (pcguide.com:ixl):	This is the command to start up FTP. The "-d" enables debug mode. In this initial step the TCP control connection is made, and the server replies with a 220 reply code indicating that it is ready for user identification. The FTP client automatically prompts for the user name.
<code>ixl</code>	USER ixl 331 User ixl okay, need password.	I use "ixl" for user names commonly. Here, the FTP client sends the user name and the server responds back asking for the password.
<code>****</code>	PASS XXXX 230-You are user #1 of 300 simultaneous users allowed. 230- 230- 230-Welcome to (<system name>) 230- 230 Logged in. SYST 215 UNIX Type: L8 Remote system type is UNIX. Using binary mode to transfer files.	I enter my password, which is sent to the FTP server, and a bunch of stuff happens. ☺ The server authenticates me and sends back a 230 message. This tells me the login was successful. It also provides me with additional information. The FTP client then automatically sends a SYST command to tell me what type of system the server is using, in this case UNIX. The client also tells me that binary mode has been selected by default; this is often the default when doing FTP from UNIX to UNIX (as I am doing here) since there is no need for ASCII mode when moving text files between similar systems.

Table 234: Sample FTP Session (Page 2 of 3)

User Command	FTP Protocol Command / FTP Server Reply	Comments
<code>pwd</code>	PWD 257 "/usr/home/ixl" is cwd.	I check the current working directory ("cwd"), which the server tells me is my own home directory on this system.
<code>cd ftptest</code>	CWD ftptest 550 No such directory.	I try to go to a directory called "ftptest" but that was the wrong name, so I get a 550 error for my trouble. (I wasn't trying to do this, I forgot the directory name but figured I might as well show it to you anyway! ☺)
<code>cd ftpdemo</code>	CWD ftpdemo 250 "/usr/home/ixl/ftpdemo" is new cwd.	I got the name right this time and the server confirms the new working directory.
<code>dir</code>	PASV 227 Entering Passive Mode (ip1,ip2,ip3,ip4,193,224) LIST 150 Data connection accepted from ip5.ip6.ip7.ip8:4279; transfer starting. -rw-r-- 1 ixl users 16 May 22 17:47 testfile.txt 226 Listing completed.	I request a list of files from the server. The FTP client automatically issues a <i>PASV</i> command and the server responds with a port number and IP address for it to use (I have not shown the IP here for security reasons.) The directory listing is then transferred from the server to the client.
<code>asc</code>	TYPE A 200 Type okay.	I set ASCII mode. Don't really need to, as I said above, but what the heck. Note that this client allowed me to abbreviate the <i>ascii</i> command as "asc".
<code>get testfile.txt</code>	PASV 227 Entering Passive Mode (ip1,ip2,ip3,ip4,193,226) RETR testfile.txt 150 Data connection accepted from ip5.ip6.ip7.ip8:4283; transfer starting for testfile.txt (16 bytes). 226 Transfer completed. 17 bytes received in 0.10 seconds (0.17 KB/s)	I get the file in this demo directory using a <i>get</i> command. The server accepts the <i>PASV</i> command and sends the file. It initially sends a 150 reply as the transfer starts (initial positive reply) then sends 226 when it is done. Note that the port numbers used here are different (for both server and client) than they were for the directory listing I did earlier.
<code>del testfile.txt</code>	DELE testfile.txt 250 Deleted.	I delete the original file on the server.

Table 234: Sample FTP Session (Page 3 of 3)

User Command	FTP Protocol Command / FTP Server Reply	Comments
<code>cdup</code>	<code>CDUP</code> 250 "/usr/home/ixl" is new cwd.	I go up to the parent directory.
<code>rmdir ftpdemo</code>	<code>RMD ftpdemo</code> 250 Directory removed.	I remove the directory that the file was in.
<code>quit</code>	<code>QUIT</code> 221 Goodbye.	I end the FTP session. The quit command also automatically closes the FTP client and returns me to the UNIX shell.



Trivial File Transfer Protocol (TFTP)

The File [Transfer Protocol \(FTP\)](#) implements a full set of command and reply functionality that enables a user to perform a wide range of file movement and manipulation tasks between two TCP/IP machines. It is ideal as a general purpose protocol for file transfer between computers, but on certain types of hardware, it is too complex to easily implement, and provides more capabilities than are really needed. In cases where only the most basic file transfer functions are needed and simplicity and small program size is of paramount importance, a companion to FTP was created called the *Trivial File Transfer Protocol (TFTP)*.

In this section I provide a description of the operation of TFTP. I begin with an overview description of the protocol, its history and motivation, and the relevant standards that describe it. I discuss its operation in general terms and how TFTP clients and server communicate, and explain TFTP messaging in detail. I then discuss TFTP options and the TFTP option negotiation mechanism, and conclude by showing the various TFTP message formats.



Background Information: While TFTP is a distinct protocol from FTP, explaining the former is easier when the reader is familiar with the latter. I assume that the reader has some understanding of FTP, since it is the more commonly-used protocol. If you have come to this section prior to reading [the section on FTP](#), I'd recommend at least reading the [FTP overview topic](#) before proceeding.

TFTP Overview, History and Standards

The [File Transfer Protocol \(FTP\)](#) is the main protocol used for the majority of general file transfers in TCP/IP internetworks. One of the objectives of the designers of FTP was to keep the protocol relatively simple, but that was really only possible to a limited extent. To enable the protocol to be useful in a variety of cases and between many kinds of devices, FTP needed a fairly large set of features and capabilities. As a result, while FTP is not as complex as certain other protocols, it is still fairly complicated in a number of respects.

The Need for TFTP

The complexity of FTP is partially due to the protocol itself, with its dozens of commands and reply codes, and partly due to the need to use of the [Transmission Control Protocol \(TCP\)](#) for connections and data transport. The reliance on TCP means that any device wanting to use FTP needs not only the FTP program, but also a full TCP implementation as well. It must handle FTP's need for simultaneous data and control channel connections and other requirements.

For a conventional computer, like a regular PC, Macintosh or UNIX workstation, none of this is really an issue, especially with today's large hard disks and fast, cheap memory. But remember that FTP was developed over three decades ago, when hardware was slow and

memory was expensive. Furthermore, even today, regular computers are not the only devices used on networks. There are some networked devices that do not have the capabilities of “true” computers, but still need to be able to do file transfers. For these devices, a full FTP and TCP implementation is a non-trivial matter.

One of the most notable examples of devices where this is an issue are *diskless workstations*. These are computers that have no permanent storage, so when they start up, they cannot read a whole TCP/IP implementation from a hard disk like most computers do easily. They start with only a small amount of built-in software, and must obtain configuration information from a server and then download the rest of their software from another network device. The same issue arises for certain other hardware devices with no hard disks.

The process of starting up these devices is commonly called *bootstrapping* and occurs in two phases. First, the workstation is provided with an IP address and other parameters, through the use of a [host configuration protocol](#) such as [BOOTP](#) or [DHCP](#). Second, the client downloads software, such as an operating system and drivers, that let it function on the network like any other device. This requires the ability to transfer files quickly and easily. The instructions to perform this bootstrapping must fit onto a read-only memory (ROM) chip and this makes the size of the software an important issue—again, especially many years ago.

The solution to this need was to create a “light” version of FTP that would emphasize small program size and simplicity over functionality. This new protocol, called the *Trivial File Transfer Protocol (TFTP)*, was initially developed in the late 1970s, and first standardized in 1980. The modern version, called *TFTP version 2*, was documented in RFC 783 in 1981, which was revised and published as RFC 1350, [The TFTP Protocol \(Revision 2\)](#), in 1992. This is the current version of the standard.

Comparing FTP and TFTP

Probably the best way of understanding the relationship between TFTP and FTP is to compare it to [the relationship between TCP and UDP at the transport layer](#). UDP is a simplified, “stripped-down” alternative to TCP, used when simplicity is more important than rich functionality. Similarly, TFTP is a greatly simplified version of FTP that allows only basic operations and lacks some of FTP's fancy capabilities, in order to keep its implementation easy (even “trivial”!) and its program size small.

Some of the more significant specific differences between FTP and TFTP:

- ☉ **Transport:** The comparison to TCP and UDP is apt not only based on the features/ simplicity trade-off, but because FTP uses [TCP](#) for transport while TFTP uses [UDP](#). Like TFTP, UDP is simple and this makes the two ideal for embedding together as a hardware program set in a network device.
- ☉ **Limited Command Set:** FTP includes a rich set of commands to allow files to be sent, received, renamed, deleted and so forth. TFTP only allows files to be sent and received.
- ☉ **Limited Data Representations:** TFTP does not include some of FTP's fancy data representation options; it allows only simple ASCII or binary file transfers.

-
- ☉ **Lack of Authentication:** UDP uses no login mechanism or other means of authentication. This is again a simplification, though it means the operators of TFTP servers must severely restrict the files they make available for access. (It is also part of why TFTP specifically does not allow the client to perform “dangerous” file operations such as deletion.)

Due to its limitations, TFTP is a complement to the regular File Transfer Protocol, not a replacement for it. It is used only when its simplicity is important and its lack of features is not. Its most common application is bootstrapping, as described above, though it can be used for other purposes. One specific application that the TFTP standard describes for the protocol is the transport of electronic mail. While the protocol supports this explicitly, TFTP is not generally used today for this purpose.

Overview of TFTP Operation

Communication and messaging in TFTP is very different than it is in FTP because of the different transport layer protocols used by each. FTP makes use of TCP's rich functionality, including its stream data orientation, to allow it to send bytes of data directly over the FTP data connection. TCP also takes care of reliable delivery of data for FTP, ensuring files are received correctly. In contrast, since TFTP uses UDP, it must package data into individual messages for both protocol control and data communication. TFTP must also take care of timing transmissions to detect lost datagrams and then retransmitting as needed.

TFTP servers allow connections from TFTP clients to perform file send and receive operations. Many hosts that run FTP servers will also run a separate TFTP server module as well. TFTP users initiate connections by starting a TFTP client program, which generally uses a command-line interface similar to that of many FTP clients; the main difference is the much smaller number of commands in TFTP.



Key Concept: For situations where the full File Transfer Protocol (FTP) is either unnecessary or impractical, the simpler *Trivial File Transfer Protocol (TFTP)* was developed. TFTP is like FTP in that it is used for general file transfer between a client and server device, but it is stripped down in its capabilities. Rather than including a full command set and using TCP for communication like FTP, TFTP can only be used for reading or writing a single file, and uses the fast but unreliable UDP for transport. It is often preferred in situations where small files must be transferred quickly and simply, such as bootstrapping diskless workstations.

TFTP Option Extension and TFTP Options

The basic operation of TFTP has not changed since RFC 1350 was published, but a new feature was added to the protocol in 1995. RFC 1782, *TFTP Option Extension*, defines a mechanism by which a TFTP client and TFTP server can negotiate certain parameters that will control a file transfer prior to the transfer commencing. This allows more flexibility in how TFTP is used, adding a slight amount of complexity to TFTP, but not a great deal.

The option extension is backwards-compatible with regular TFTP, and is only used if both server and client support it. Two subsequent RFCs define the actual options that can be negotiated: RFC 1783, *TFTP Blocksize Option* and RFC 1784, *TFTP Timeout Interval and Transfer Size Options*. This set of three RFCs (1782, 1783 and 1784) was replaced in 1998 by updated versions in RFCs 2347, 2348 and 2349.

TFTP General Operation, Connection Establishment and Client/Server Communication

Since the “T” in “TFTP” stands for “trivial”, and the protocol was specifically designed to be simple, you would think that describing how it works would, in fact, be simple, wouldn't you? Well, actually, it pretty much is. Sorry, I couldn't resist setting you up there. ☺

TFTP communication is client/server based, as discussed in the overview. The process of transferring a file consists of three main phases. In highly generalized terms, these are:

1. **Initial Connection:** The TFTP client establishes the connection by sending an initial request to the server. The server responds back to the client and the connection is effectively opened.
2. **Data Transfer:** Once the connection is established, the client and server exchange TFTP messages. One device sends data and the other sends acknowledgments.
3. **Connection Termination:** When the last TFTP message containing data has been sent and acknowledged, the connection is terminated.

Connection Establishment and Identification

The concept of a “connection” is somewhat different in TFTP than it is with a protocol like FTP that uses TCP. FTP must establish a connection at the TCP level before anything can be done by FTP itself. TFTP, however, uses the [connectionless](#) UDP for transport, so there is no connection in the sense that one exists in TCP. In TFTP, the connection is more in a “logical sense”, meaning that the client and server are participating in the protocol and exchanging TFTP messages.

The TFTP server listens continuously for requests on [well-known](#) UDP port number 69, which is reserved for TFTP. The client chooses for its initial communication an [ephemeral port number](#), as is usually the case in TCP/IP. This port number actually identifies the data transfer, and is called a *transfer identifier (TID)*.

What's different about TFTP, however, is that the server also selects a pseudo-random TID that it uses for sending responses back to the client; it doesn't send them from port number 69. The reason this is done is that by using unique client port number and source port number, multiple TFTP exchanges can be conducted simultaneously by a server. Each transfer is identified automatically by the source and destination port number, so there is no need to identify in data messages the transfer to which each block data belongs. This keeps the TFTP header size down, allowing more of each UDP message to contain actual data.

For example, suppose the TFTP client selects a TID of 3,145 for its initial message. It would send a UDP transmission from its port 3,145 to the server's port 69. Say the server selects a TID of 1,114. It would send its reply from its port 1,114 to the client's port 3,145. From then on, the client would send messages back to server port 1,114 until the TFTP session was completed.

"Lock-Step" Client/Server Messaging

After the initial exchange, the client and server exchange data and acknowledgment messages in "lock-step" fashion. Each device sends a message for each message it receives: one device sends data messages and waits for acknowledgments, the other sends acknowledgments and waits for data messages. This form of rigid communication is less efficient than allowing the transmitter to "fire away" with one data message after another, but is important because it keeps TFTP simple when it comes to an important issue: retransmissions.

Like all protocols using the unreliable UDP, TFTP has no assurances that any messages sent will in fact arrive at their destination, so it must use timers to detect lost transmissions and resend them. What is different about TFTP is that both clients and servers perform retransmission. The device that is sending data messages will resend the data message if it doesn't receive an acknowledgment in a reasonable period of time; the device sending the acknowledgments will resend the acknowledgment if it doesn't receive the next data message promptly. The "lock-step" communication discussed above greatly simplifies this process, since each device only needs to keep track of one "outstanding" message at a time. It also eliminates the need to deal with complications such as reorganizing blocks received out of order (which protocols like FTP rely on TCP to manage.)



Key Concept: Since TFTP uses UDP rather than TCP, there is no explicit concept of a connection as in FTP. A TFTP session instead uses the concept of a "logical connection", which is opened when a client sends a request to a server to read or write a file. Communication between the client and server is performed in "lock-step" fashion: one device sends data messages and receives acknowledgments so it knows the data messages were received; the other sends acknowledgments and receives data messages so it knows the acknowledgments were received.

Difficulties With TFTP's Simplified Messaging Mechanism

One of the most important drawbacks with this technique is that while it simplifies communication, it does so at the cost of **performance**. Since only one message can be in transit at a time, this limits throughput to a maximum of 512 bytes for exchange of messages between the client and server. In contrast, when using FTP, large amounts of data can be pipelined; there is no need to wait for an acknowledgment for the first piece of data before sending the second.

Another complication is that if a data or acknowledgment message is re-sent and the original was not lost but rather just delayed, two copies will show up. The original TFTP protocol rules stated that upon receipt of a duplicate datagram, the device receiving it may re-send the current datagram again. So, receipt of a duplicate block #2 by a client doing a read would result in the client sending a duplicate acknowledgment for block #2. This would mean two acknowledgments received by the server, which would in turn send block #3 twice. Then there would be two acknowledgments for block #3, and so on.

The end result of this is that once the initial duplication occurs, every message thereafter is sent twice. This has been affectionately dubbed the *Sorcerer's Apprentice Bug*, after the story used as the basis of the famous scene in Disney's *Fantasia* where Mickey Mouse cuts animated brooms in half only to find that in turn, each half comes to life. This problem was fixed by changing the rules so that only the device receiving a duplicate **data** message may send a duplicate acknowledgment. Receipt of a duplicate **acknowledgment** does not result in sending a duplicate data message. Since only one of the two devices can send duplicates, this fixes the problem.

It's also worth emphasizing that TFTP includes absolutely no security, so there is no login or authentication process. As mentioned in [the overview](#), administrators must use caution in deciding what files to make available via TFTP, and in allowing write access to TFTP servers.

TFTP Detailed Operation and Messaging

TFTP operation consists of [three general steps](#): initial connection, data transfer, and connection termination. All operations are performed through the exchange of specific TFTP messages. Let's take a more detailed look now at these three phases of operation and the specifics of TFTP messaging functions.

Initial Message Exchange

The first message sent by the client to initiate TFTP is either a *read request (RRQ)* message or a *write request (WRQ)* message. This message serves to implicitly establish the logical TFTP connection, and to indicate if the file is to be sent from the server to the client (read request) or the client to the server (write request). The message also specifies the type of file transfer to be performed. TFTP supports two transfer modes: *netascii* mode (ASCII text files as used by the [Telnet Protocol](#)) and *octet* mode (binary files).



Note: There was originally a third file type option—*mail* mode—but TFTP was never really designed for transmitting mail and this option is now obsolete.

Assuming there was no problem with the request (such as a server problem, inability to find the file, etc.) the server will respond with a positive reply. In the case of a read request, the server will immediately send the first data message back to the client. In the case of a write request, the server will send an acknowledgment message to the client, telling it that it may proceed to send the first data message.

After the initial exchange, the client and server exchange data and acknowledgment messages in “lock-step” fashion as described in [the previous topic](#). For a read, the server sends one data message and waits for an acknowledgment from the client before sending the next one. For a write, the client sends one data message and the server sends an acknowledgment for it, before the client sends the next data message.

If there is a problem at any stage of the connection establishment or transfer process, a device may reply with an error message instead of a data or acknowledgment message, as appropriate. An error message normally results in the failure of the data transfer; this is one of the prices paid for the simplicity of TFTP.

Each TFTP file transfer proceeds using one of the processes described below, which either reads or writes a single file. If another file needs to be sent or received, a new logical communication is established, in a manner analogous to how FTP creates [data connections](#). The main difference is that TFTP has no [persistent control connection](#) like FTP does.

Data Block Numbering

Each data message contains a block of between 0 and 512 bytes of data. The blocks are numbered sequentially, starting with 1. The number of each block is placed in the header of the data message carrying that block, and then used in the acknowledgment for that block so the original sender knows it was received. The device sending the data will always send 512 bytes of data at a time for as long as it has enough data to fill the message. When it gets to the end of the file and has fewer than 512 bytes to send, it will send only as many bytes as remain. Interestingly, this means that if the size of the file is an exact multiple of 512, the last message sent will have zero bytes of data!

The receipt of a data message with between 0 and 511 bytes of data signals that this is the last data message. Once this is acknowledged, this automatically signals the end of the data transfer. There is no need to explicitly terminate the “connection”, just as it was not necessary to explicitly establish it.

TFTP Read Process Steps

Let's use an example to see how TFTP messaging works. Suppose the client wants to read a particular file that is 1,200 bytes long. Here are the steps in simplified form (also displayed in [Figure 293](#)):

1. The client sends a read request to the server, specifying the name of the file.
2. The server sends back a data message containing block #1, carrying 512 bytes of data.
3. The client receives the data, and sends back an acknowledgment for block #1.

4. The server sends block #2, with 512 bytes of data.
5. The client receives block #2, and sends back an acknowledgment for it.
6. The server sends block #3, containing 176 bytes of data. It waits for an acknowledgment before terminating the logical connection.
7. The client receives the data, sends an acknowledgment for block #3. Since this data message had fewer than 512 bytes, it knows the file is complete.
8. The server receives the acknowledgment, and knows the file was received successfully.

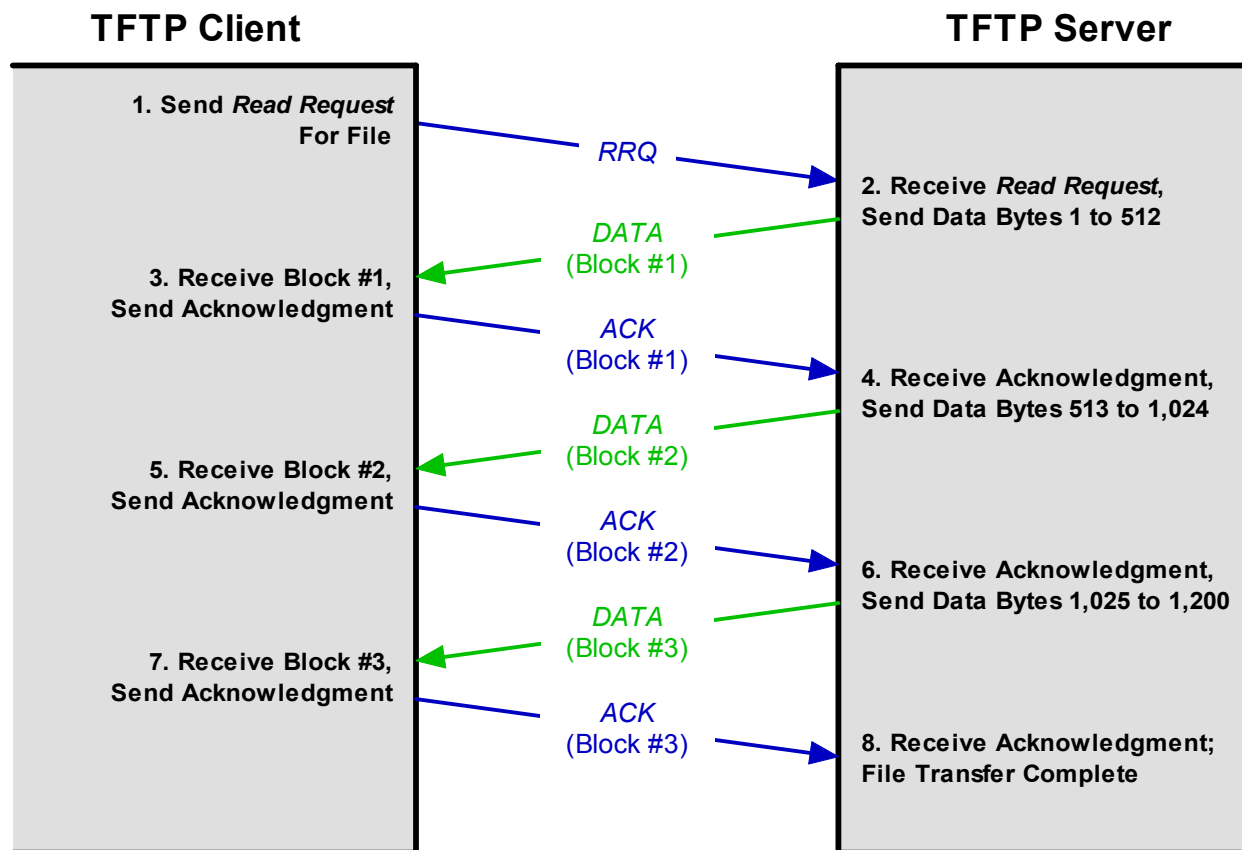

Figure 293: TFTP Read Process

In this example, the client starts the process of reading a file by sending a request for it to the server. The server acknowledges this request by immediately sending a *DATA* message carrying block #1, containing the first 512 bytes of the file. The client acknowledges this with an *ACK* message for block #1. The server then sends block #2, containing bytes 513 to 1,024, which the client acknowledges. When the client receives block #3, it realizes it has only 176 bytes, which marks it as the last block of the file.

TFTP Write Process Steps

Here are the steps in the same process, but where the client is writing the file (see [Figure 294](#)):

1. The client sends a write request to the server, specifying the name of the file.

-
2. The server sends back an acknowledgment. Since this acknowledgment is prior to the receipt of any data, it uses block number zero in the acknowledgment.
 3. The client sends a data message containing block #1, 512 bytes of data.
 4. The server receives the data, sends back an acknowledgment for block #1.
 5. The client sends block #2, 512 bytes of data.
 6. The server receives the data, sends back an acknowledgment for block #2.
 7. The client sends block #3, containing 176 bytes of data. It waits for an acknowledgment before terminating the logical connection.
 8. The server receives block #3 and sends an acknowledgment for it. Since this data message had fewer than 512 bytes, the transfer is done.
 9. The client receives the acknowledgment for block #3 and knows the file write was completed successfully.



Key Concept: A TFTP *read operation* begins with the client sending a *Read Request* message to the TFTP server; the server then sends the file in 512-byte *Data* messages, waiting after each one for the client to acknowledge receipt before sending the next. A TFTP *write operation* starts with a *Write Request* sent by the client to the server, which the server acknowledges. The client then sends the file in 512-byte *Data* blocks, waiting after each for the server to acknowledge receipt. In both cases there is no explicit means by which the end of a transfer is marked; the device receiving the file simply knows the transfer is complete when it receives a *Data* message containing fewer than 512 bytes.

TFTP Options and Option Negotiation

One of the difficulties that designers of simple protocols and applications seem to have is **keeping** them simple. Many protocols start out small but over time, well-intentioned users suggest improvements that are added slowly but surely. Eventually, the program that was once “lean and mean” has become, well, shall we say, “well-marbled”. ☺ In the software industry, this is called “feature creep” and it has happened to many protocols and applications.

The temptation to add features is especially strong when the program or protocol has few to begin with. Given this, the maintainers of the TFTP protocol have done a good job over the years of avoiding this pitfall. However, they did allow one new feature to be added to the protocol in 1995: the *TFTP Option Extension*, which describes how a TFTP client and server can negotiate *options* before transferring a file.

The reason for adding this capability is that the original TFTP protocol provided no way at all for the client and server to exchange important control information prior to sending a file. This limited the flexibility of the protocol to deal with special cases, such as the transfer of data over unusual network types. The TFTP option negotiation feature allows additional parameters to be exchanged between the client and server which govern how data is trans-

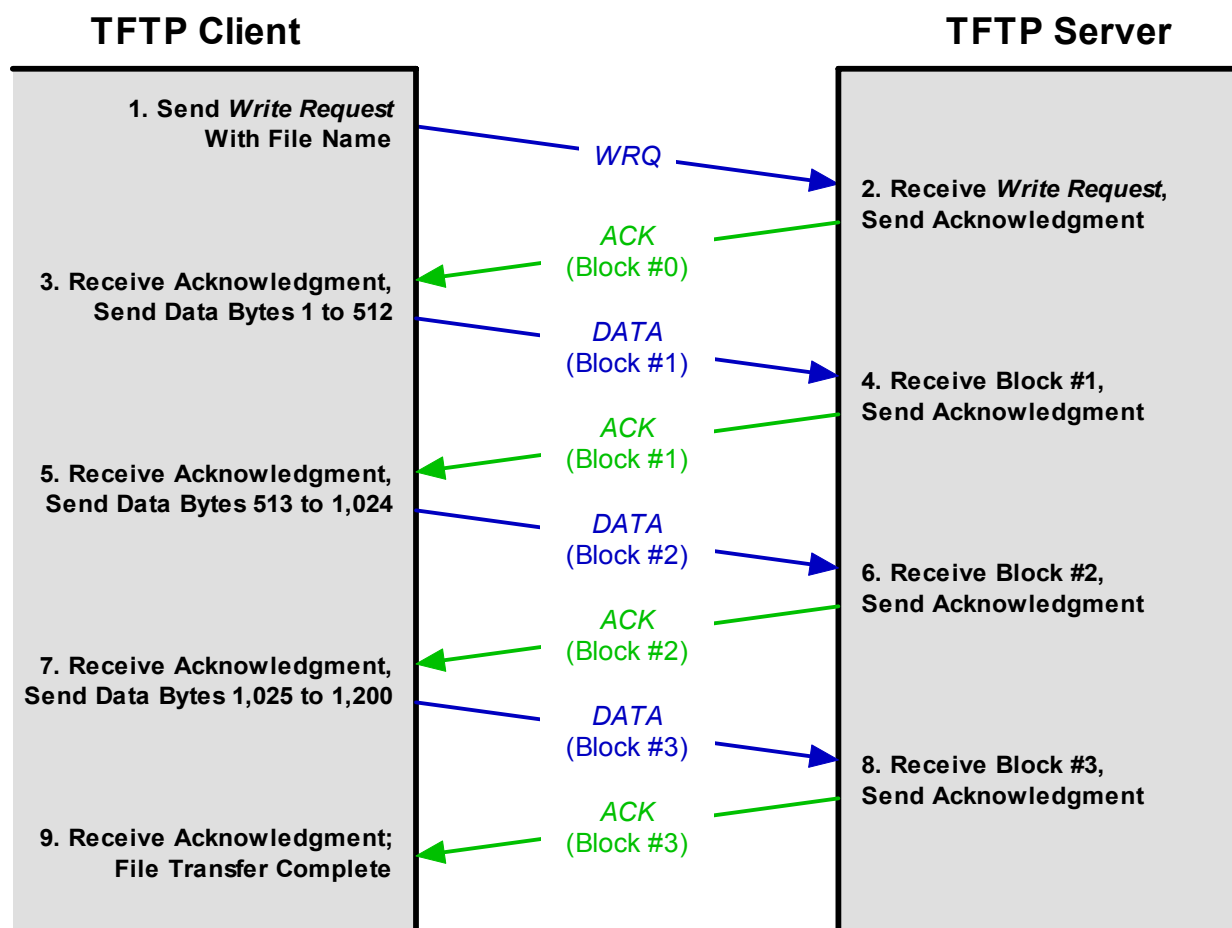

Figure 294: TFTP Write Process

This example shows the client sending the same 1,200-byte file to the server that it read in [Figure 293](#). The client sends a write request to the server, which acknowledges it; it uses block #0 to represent acknowledgment of the request prior to receipt of any data. The client then sends blocks of data one at a time, each of which is acknowledged by the server. When the server receives block #3 containing fewer than 512 bytes of data, it knows it has received the whole file.

ferred. It does this without significantly complicating the protocol, and is backward-compatible with normal TFTP. It is only used if both client and server support it, and one device trying to use the feature will not cause problems if the other doesn't support it.

TFTP Option Negotiation Process

The client begins the negotiation by sending a modified TFTP *Read Request* or *Write Request* message. In addition to the normal information that appears in this message (see the next topic), a list of options may also be included. Each is specified with an *Option Code* and an *Option Value*. The names and values are expressed as ASCII strings, terminated by a null character (zero byte). Multiple options may be specified in the request message.

The server receives the request containing the options, and if it supports the option extension, processes them. It then returns a special *Option Acknowledgment (OACK)* message to the client, where it lists all the options that the client specified that the server recognizes and accepts. Any options that the client requested but the server rejects, it does not include in this option acknowledgment. The client may only use the options that the server accepts. If the client rejects the server's response, it may send back an error message (with error code 8) upon receipt of the unacceptable *OACK* message.

The server may specify an alternative value in its response for certain options, if it recognizes the option but doesn't like the client's suggested value. Obviously, if the server doesn't support options at all, it will ignore the client's option requests, and respond back with a data message (for a read) or a regular acknowledgment (for a write) as in normal TFTP.

If the server did send an *OACK*, the client then proceeds to send messages using the regular messaging exchange described in the previous section. In the case of a write, the option acknowledgment replaces the regular acknowledgment in the message dialog. In the case of a read, the option acknowledgment is the server's first message instead of the first data block that it would normally send. TFTP doesn't allow the same device to send two datagrams in a row, so there needs to be a reply from the client before that first block can be sent. The client does this by sending a regular acknowledgment with a block number of 0 in it — the same form of acknowledgment a server normally sends for a write.



Key Concept: TFTP is supposed to be a small and simple protocol, so it includes few “extra” features. One that it does support is *option negotiation*, where a TFTP client and server attempt to come to agreement on additional parameters that they will use in transferring a file. The TFTP client includes one or more options in its *Read Request* or *Write Request* message; the TFTP server then sends an *Option Acknowledgment (OACK)* message listing each option the server agrees to use. The use of options when reading a file means that an extra acknowledgment must be sent by the client--to acknowledge the *OACK*--before the server sends the first block of the file.

Phew, that's confusing. For review, let's take a look at each of the four possible cases (read and write, with and without options).

TFTP Read Process With and Without Option Negotiation

The initial message exchange for a normal read (without option negotiation), as shown in [Figure 293](#):

1. Client sends *Read Request*.
2. Server sends *Data* block #1.
3. Client acknowledges data block #1.

And so on...

And now, a read with option negotiation ([Figure 295](#)):

1. Client sends *Read Request* with options.
2. Server sends *Option Acknowledgment*.
3. Client sends regular acknowledgment for “block #0”, that is, it acknowledges the *OACK*.
4. Server sends data block #1.
5. Client acknowledges data block #1.
- Etc...

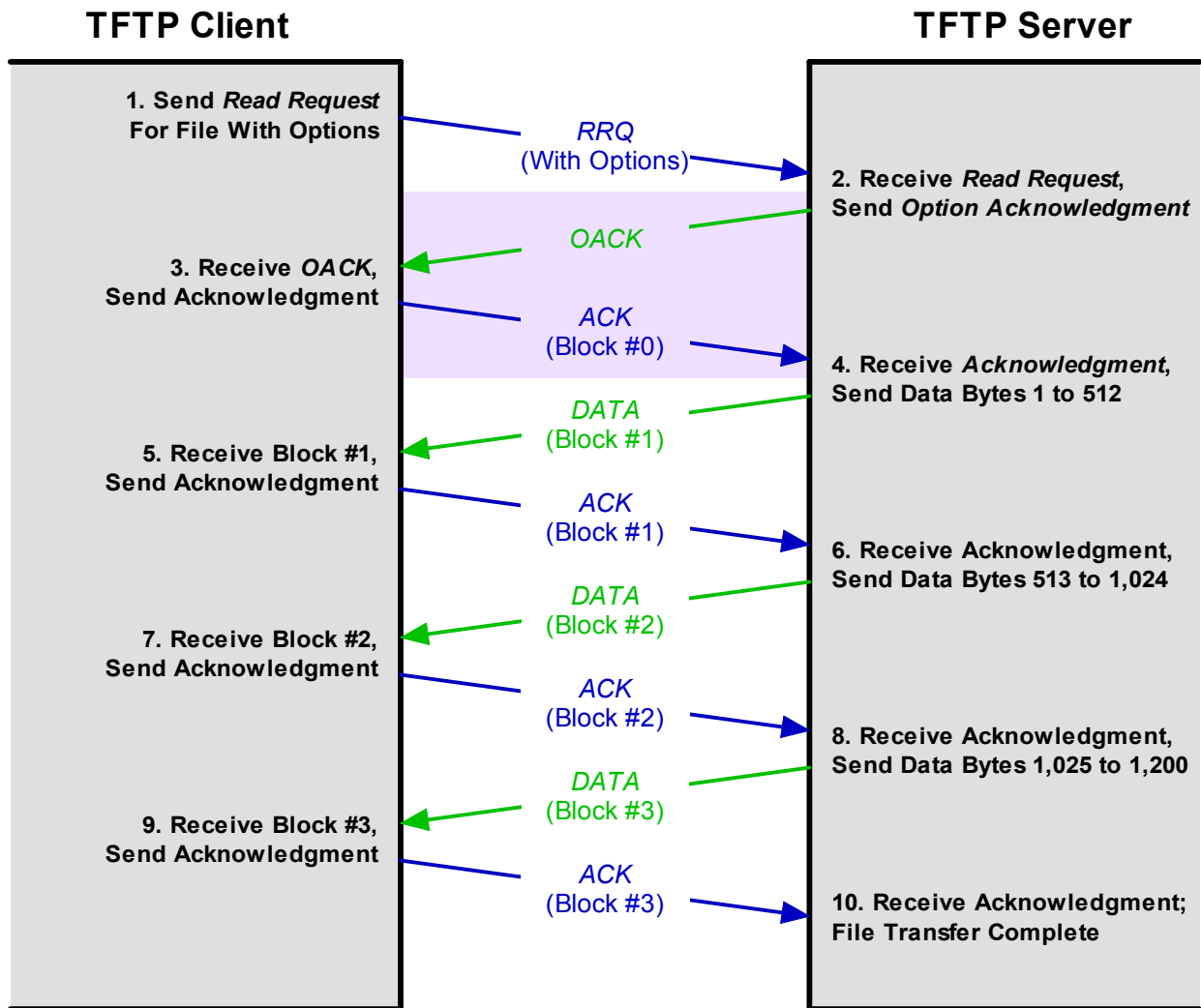

Figure 295: TFTP Read Process With Option Negotiation

This diagram shows the same example illustrated in [Figure 293](#), but with one added message exchange used for option negotiation (purple background). The client's initial *Read Request* here includes options that it wants to use for this transfer. The server responds not immediately with the first data block, but with an *Option Acknowledgment*. The client indicates receipt of the *OACK* by sending an acknowledgment using block #0. The server sends data block #1 and the rest of the exchange proceeds as normal.

TFTP Write Process With and Without Option Negotiation

The initial message exchange for a normal write (without option negotiation):

1. Client sends write request.
2. Server sends acknowledgment.
3. Client sends data block #1.
4. Server acknowledges data block #1.

...

And a write with option negotiation:

1. Client sends write request with options.
2. Server sends option acknowledgment (instead of regular acknowledgment).
3. Client sends data block #1.
4. Server acknowledges data block #1.

...

TFTP Options

[Table 235](#) contains a summary of the three TFTP options currently defined.

Table 235: TFTP Options

TFTP Option Name	TFTP Option Code (Used in Request Messages)	Defining RFC	Description
Block Size	<i>blksize</i>	2348	Allows the client and server to send data blocks of a size different than 512 bytes, to improve efficiency or address limitations of a particular type of network.
Timeout Interval	<i>interval</i>	2349	Permits the client and server to agree on a specified number of seconds to use for their retransmission timers. Again, may be of value on certain networks with high latency or other special requirements.
Transfer Size	<i>tsize</i>	2349	Lets the device sending the file (client on a write, server on a read) tell the other device the size of the file before the transfer commences. This allows the receiving device to allocate space for it in advance.

TFTP Message Formats

Unlike FTP, all communication in TFTP is accomplished in the form of discrete messages that follow a particular message format. The reason why TFTP and FTP are so different in this regard is the different transport protocols they use. FTP uses TCP, which allows data to be streamed a byte at a time; FTP also makes use of a dedicated channel for commands. TFTP runs on UDP, which uses a conventional “header/data” formatting scheme.

The original TFTP standard defines five different types of messages: *Read Request (RRQ)*, *Write Request (WRQ)*, *Data (DATA)*, *Acknowledgment (ACK)* and *Error (ERROR)*. The [TFTP option extension](#) feature defines a sixth message: *Option Acknowledgment (OACK)*. Of these six messages, the first two share the same message format. The others all have their own unique format. The only common field in every TFTP message is the *Operation Code (Opcode)*, which tells the recipient of the message what type it is.

TFTP's message formats are different than those used for certain other protocols because many of the fields are variable in length. Usually, variable-length fields in messages are expressed using a preceding length field that specifies the length of the variable-sized field. Instead, TFTP sends such fields as strings of ASCII characters using *netascii*, the [Telnet](#) version of ASCII. The end of the string is marked by a zero byte. The exception to this is the data field in *Data* messages, the content of which depends on the transfer mode.

You will find below the details of each TFTP message type.

Read Request and Write Request Messages

These messages use a common message format, described in [Table 236](#) and shown graphically in [Figure 296](#).

Table 236: TFTP Read Request / Write Request Message Format

Field Name	Size (bytes)	Description									
Opcode	2	Operation Code: Specifies the TFTP message type. A value of 1 indicates a <i>Read Request</i> message, while a value of 2 is a <i>Write Request</i> message.									
Filename	Variable	Filename: The name of the file to be read or written.									
Mode	Variable	Transfer Mode: The string “netascii” or “octet”, zero-terminated. (Why not just use one byte set to 0 for netascii and 1 for octet? Don't ask <i>me!</i> ☺)									
Options	Variable	Options: When the client supports TFTP options, it will encode them in sequence following the <i>Mode</i> field. Each option consists of these subfields:									
		<table border="1"> <thead> <tr> <th>Subfield Name</th> <th>Size (bytes)</th> <th>Description</th> </tr> </thead> <tbody> <tr> <td>optN</td> <td>Variable</td> <td>Option Code for Option #N: A string specifying the name of the option; currently, “blksize”, “interval” and “tsize” are supported.</td> </tr> <tr> <td>valueN</td> <td>Variable</td> <td>Option Value for Option #N: The value the client is requesting for this option. Note that this is a zero-terminated string just like other TFTP variable-length fields, even for a numeric value.</td> </tr> </tbody> </table>	Subfield Name	Size (bytes)	Description	optN	Variable	Option Code for Option #N: A string specifying the name of the option; currently, “blksize”, “interval” and “tsize” are supported.	valueN	Variable	Option Value for Option #N: The value the client is requesting for this option. Note that this is a zero-terminated string just like other TFTP variable-length fields, even for a numeric value.
		Subfield Name	Size (bytes)	Description							
optN	Variable	Option Code for Option #N: A string specifying the name of the option; currently, “blksize”, “interval” and “tsize” are supported.									
valueN	Variable	Option Value for Option #N: The value the client is requesting for this option. Note that this is a zero-terminated string just like other TFTP variable-length fields, even for a numeric value.									

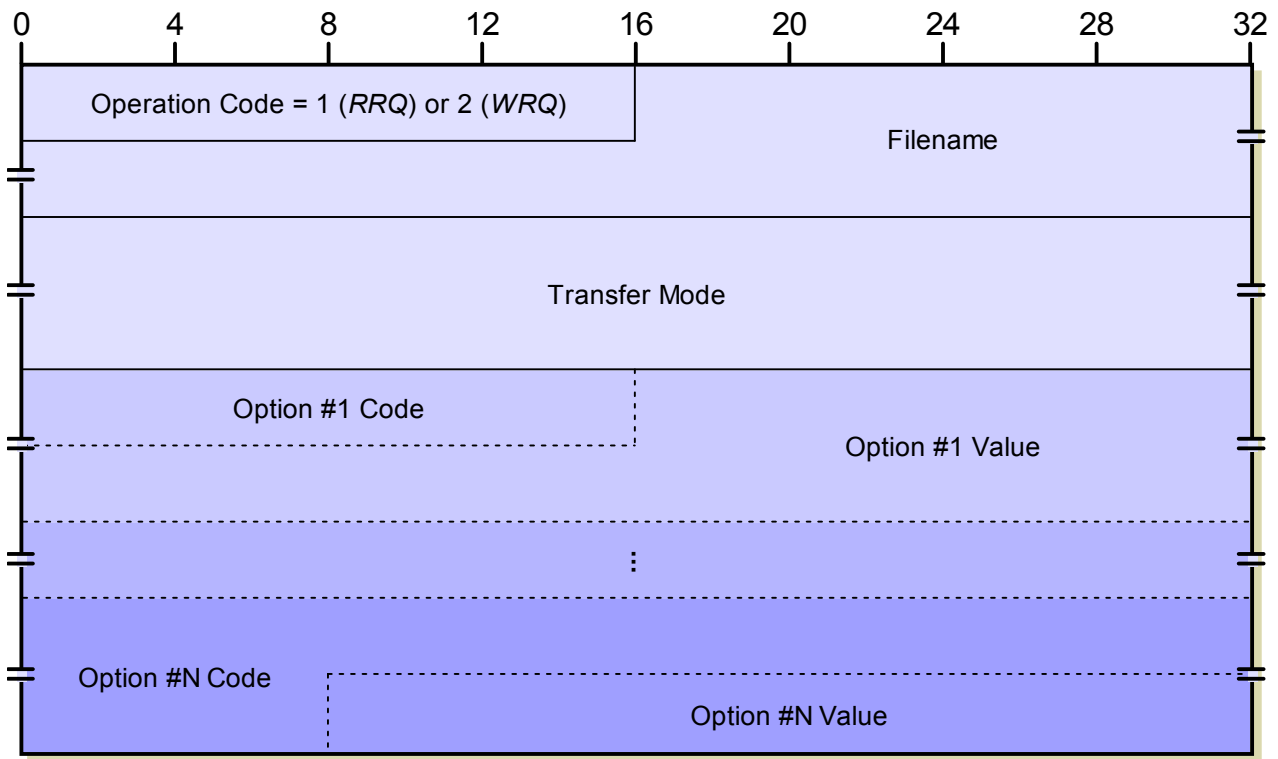

Figure 296: TFTP Read Request / Write Request Message Format

Data Messages

Data blocks are sent using the simplified format shown in [Table 237](#) and [Figure 297](#).

Table 237: TFTP Data Message Format

Field Name	Size (bytes)	Description
Opcode	2	Operation Code: Specifies the TFTP message type. A value of 3 indicates a <i>Data</i> message.
Block #	2	Block Number: The number of the data block being sent.
Data	Variable	Data: 0 to 512 bytes of data.

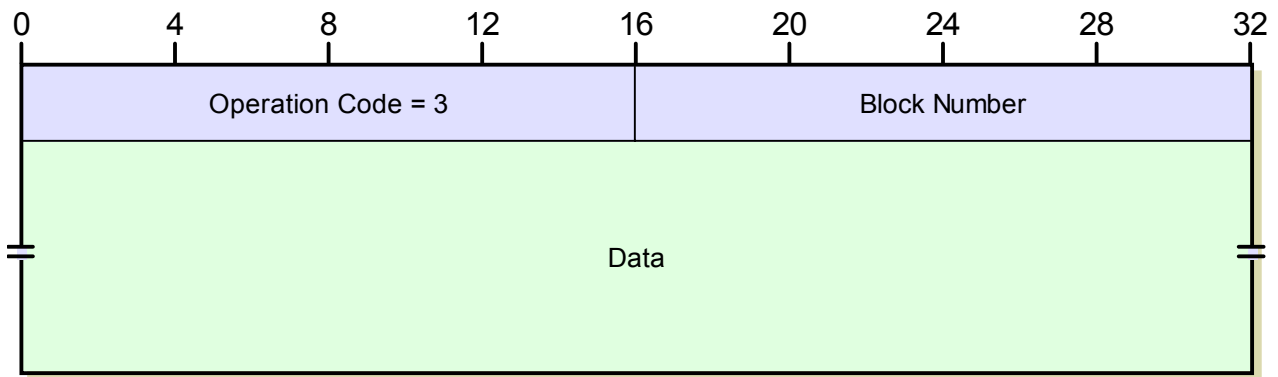

Figure 297: TFTP *Data* Message Format

Acknowledgment Messages

Acknowledgments have the simplest format of any TFTP message, as you can see in [Table 238](#) and [Figure 298](#).

Table 238: TFTP *Acknowledgment* Message Format

Field Name	Size (bytes)	Description
<i>Opcode</i>	2	<i>Operation Code:</i> Specifies the TFTP message type. A value of 4 indicates an <i>Acknowledgment</i> message.
<i>Block #</i>	2	<i>Block Number:</i> The number of the data block being acknowledged; a value of 0 is used to acknowledge receipt of a write request without options, or to acknowledge receipt of an option acknowledgment.

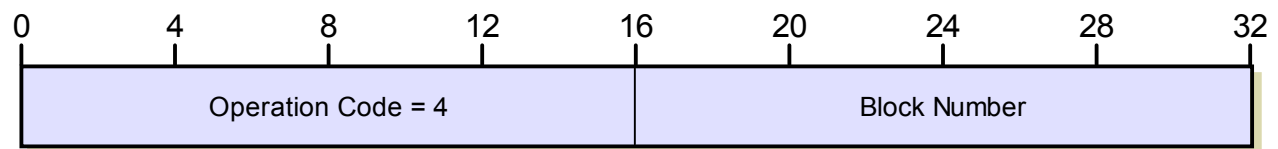

Figure 298: TFTP *Acknowledgment* Message Format

Error Messages

Error messages can be sent by either client or server in cases where a problem is detected in the communication. They have the format indicated in [Table 239](#) and [Figure 299](#).

Table 239: TFTP Error Message Format

Field Name	Size (bytes)	Description																				
Opcode	2	Operation Code: Specifies the TFTP message type. A value of 5 indicates an <i>Error</i> message.																				
Error Code	2	<p>Error Code: A numeric code indicating the type of message being communicated. Values 0 to 7 are defined by the TFTP standard, while value 8 was added by the TFTP option extension:</p> <table border="1"> <thead> <tr> <th>Error Code Value</th> <th>Error Type</th> </tr> </thead> <tbody> <tr> <td>0</td> <td>Not defined; see error message field for details.</td> </tr> <tr> <td>1</td> <td>File not found.</td> </tr> <tr> <td>2</td> <td>Access violation.</td> </tr> <tr> <td>3</td> <td>Disk full or allocation exceeded.</td> </tr> <tr> <td>4</td> <td>Illegal TFTP operation.</td> </tr> <tr> <td>5</td> <td>Unknown transfer ID.</td> </tr> <tr> <td>6</td> <td>File already exists.</td> </tr> <tr> <td>7</td> <td>No such user.</td> </tr> <tr> <td>8</td> <td>Client transfer termination due to unacceptable option negotiation.</td> </tr> </tbody> </table>	Error Code Value	Error Type	0	Not defined; see error message field for details.	1	File not found.	2	Access violation.	3	Disk full or allocation exceeded.	4	Illegal TFTP operation.	5	Unknown transfer ID.	6	File already exists.	7	No such user.	8	Client transfer termination due to unacceptable option negotiation.
Error Code Value	Error Type																					
0	Not defined; see error message field for details.																					
1	File not found.																					
2	Access violation.																					
3	Disk full or allocation exceeded.																					
4	Illegal TFTP operation.																					
5	Unknown transfer ID.																					
6	File already exists.																					
7	No such user.																					
8	Client transfer termination due to unacceptable option negotiation.																					
Error Msg	Variable	Error Message: A descriptive text error message string, intended for “human consumption”, as the standard puts it. ☺																				

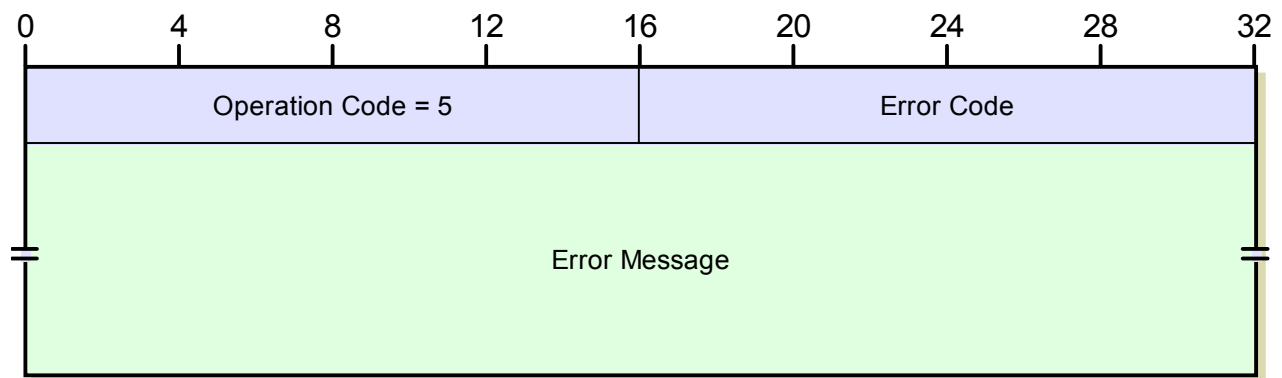

Figure 299: TFTP Error Message Format

Option Acknowledgment Messages

OACK messages are used to acknowledge receipt of TFTP options. They are structured as shown in [Table 240](#) and [Figure 300](#).

Table 240: TFTP Option Acknowledgment Message Format

Field Name	Size (bytes)	Description									
Opcode	2	Operation Code: Specifies the TFTP message type. A value of 6 indicates an <i>Option Acknowledgment</i> message.									
Options	Variable	Options: A list of options being acknowledged by the server. Each option consists of these two subfields:									
		<table border="1"> <thead> <tr> <th>Subfield Name</th> <th>Size (bytes)</th> <th>Description</th> </tr> </thead> <tbody> <tr> <td>optN</td> <td>Variable</td> <td>Option Code for Option #N: A string specifying the name of the option, copied from the <i>Read Request</i> or <i>Write Request</i> message.</td> </tr> <tr> <td>valueN</td> <td>Variable</td> <td>Option Value for Option #N: The acknowledged value for the option, which may be the value that the client specified, or an alternative value, depending on the type of option.</td> </tr> </tbody> </table>	Subfield Name	Size (bytes)	Description	optN	Variable	Option Code for Option #N: A string specifying the name of the option, copied from the <i>Read Request</i> or <i>Write Request</i> message.	valueN	Variable	Option Value for Option #N: The acknowledged value for the option, which may be the value that the client specified, or an alternative value, depending on the type of option.
		Subfield Name	Size (bytes)	Description							
optN	Variable	Option Code for Option #N: A string specifying the name of the option, copied from the <i>Read Request</i> or <i>Write Request</i> message.									
valueN	Variable	Option Value for Option #N: The acknowledged value for the option, which may be the value that the client specified, or an alternative value, depending on the type of option.									

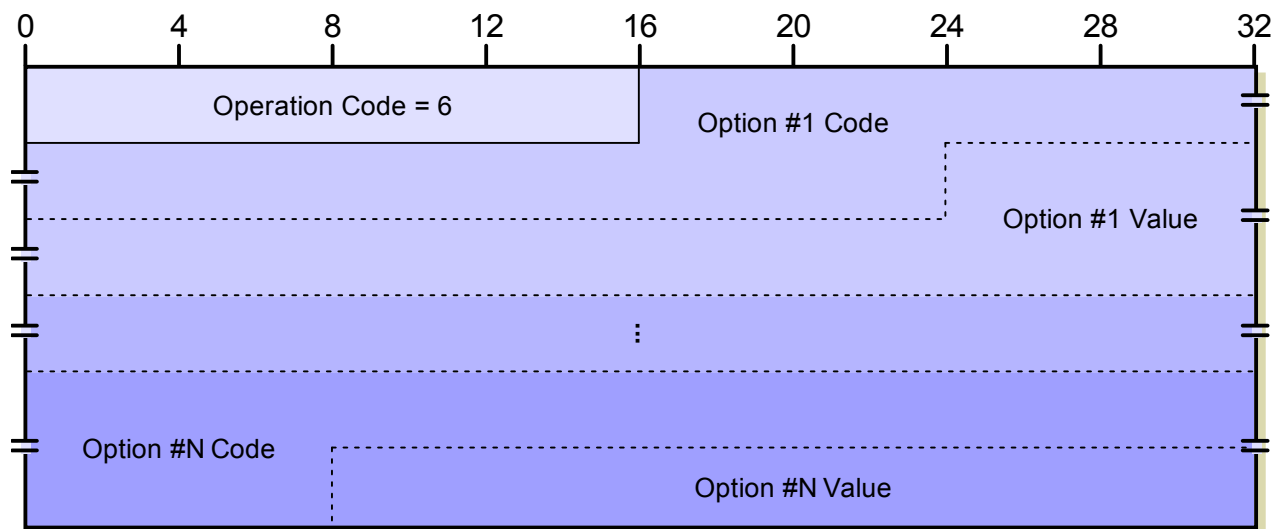

Figure 300: TFTP Option Acknowledgment Message Format



TCP/IP Electronic Mail System: Concepts and Protocols (RFC 822, MIME, SMTP, POP3, IMAP)

It is common for human beings to create systems that are reminiscent of ones to which they are already accustomed. We are all accustomed to using the regular mail system to send letters and other documents from our location to recipients anywhere that the postal system serves. Naturally, one of the first applications of internetworks was to create an electronic version of this conventional mail system that would allow messages to be sent in a similar manner, but more quickly and easily. Over the course of many years, an *electronic mail system* for TCP/IP was created and refined. It is now the most widely used means of electronic messaging in the world.

In this section I describe TCP/IP electronic mail in detail, in five sections that discuss electronic mail concepts and the various components and protocols that comprise the overall TCP/IP e-mail system. The first subsection provides an overview of TCP/IP electronic mail and discusses the way that it is used and the different protocols and methods that comprise the system. The second discusses how e-mail messages are addressed, and the third covers standard and special formats for e-mail messages. The fourth and fifth subsections describe the TCP/IP protocols that implement electronic mail functionality. This includes an examination of the Simple Mail Transfer Protocol (SMTP), which is responsible for the delivery of e-mail, and several protocols and methods used for mailbox access and mail retrieval, including POP3 and IMAP.



Note: This discussion focuses primarily on the mechanisms used for electronic mail composition, delivery and access in modern internetworks. In the e-mail overview topic I make mention of some techniques used in the past for TCP/IP electronic mail, but only briefly for historical completeness, and to contrast these methods to the ones presently used.

TCP/IP Electronic Mail System Overview and Concepts

Electronic mail in the TCP/IP protocol suite is not implemented as just a single protocol or technology. Rather, it is a complete **system** that contains a number of related components that work together. These include standards defining methods for addressing and message formatting, and a number of protocols that play different functions in implementing electronic mail messaging. Before proceeding to examine each of these pieces, it makes sense to start with an overview of the system as a whole.

In this section I provide an introductory look at TCP/IP electronic mail, to help you understand the system, how it works, and how different components fit into it. I begin with an overview and history of e-mail and its implementation in TCP/IP. I provide a general overview of the steps involved in the e-mail communication process. I conclude with a more specific discussion of the communication model used in TCP/IP and the roles played by various TCP/IP devices and protocols in the sending and receiving of electronic mail.

TCP/IP Electronic Mail System Overview and History

The need to communicate is as old as humanity itself. Thousands of years ago, communication was, of necessity, almost exclusively local. Messages were primarily oral, and even when in writing, rarely delivered a great distance. Most people never travelled far from their homes, and rarely communicated with those distant from themselves. But even in ancient times, messengers were used by leaders to send short pieces of critical information from place to place. It was slow and unreliable, but some messages were important enough that an effort to communicate often had to be made in spite of the difficulties.

Advances in transportation led to advances in communication capability, eventually resulting in the creation of physical mail systems. Today, these systems have evolved to the point where anyone in the developed world can send a letter to just about anyone else. Reliability has vastly improved, despite all the jokes people make about the postal service. ☺ Speed is also much better than it was in the olden times, with messages now taking days to reach their destination instead of weeks or months.

Waiting even days for a message to get from one place to another is pretty slow by the standards of our modern world. For this reason, one of the most natural applications of networks was to use them as a replacement for the physical transportation of messages from one place to another. Transforming mail from a physical process to an electronic one yields enormous benefits, chief among them greatly increased communication speed, the ability to instantly send one message to multiple recipients, and the ability to get nearly instantaneous feedback upon receipt of a message.

The Early Days of Electronic Mail

The idea behind *electronic mail* (*e-mail* or *email*) is not only as old as computer networks, it actually predates internetworking. The first electronic mail systems were implemented on traditional mainframe computers. These are single large computers accessed by many users simultaneously through connected terminals. An e-mail system on a mainframe consisted of a set of software running on the mainframe that implemented the entire

electronic mail system. Each user simply had a mailbox that resided on this machine, and mail was “delivered” by moving messages from one mailbox to the next. Users sent and received mail through a user interface program.

Such an early electronic mail system was useful for local communication, but not for sending messages to a person in another organization. Mainframe e-mail is somewhat analogous to “local mail” being sent by one resident of a town to another. There is no way to send mail to a person in a distant town without more infrastructure for delivery.

The power of internetworking is what really enables electronic mail to become a universal method of communication. Internetworks link together systems the way the postal service's fleet of airplanes and vehicles link together post offices. Mail is sent from user to user over the underlying technology of the internetwork. TCP/IP is of course the most commonly used internetworking protocol suite, and the modern Internet uses TCP/IP to tie together systems across the globe. It is thus “the vehicle” for sending electronic mail.

The History of TCP/IP Electronic Mail

Like some other file and message transfer protocols, e-mail on TCP/IP actually goes back to [before TCP/IP and the Internet formally existed](#). The first protocols for e-mail were developed during the days of the ARPAnet. Prior to the creation of e-mail, several Internet RFCs, such as RFC 95 (yes 95, two digits, we are going back a long way here!) and RFC 155 describe physical mailing lists that were used for distributing documents in the early 1970s. It was this need to send documents that likely made TCP/IP pioneers realize how useful an electronic messaging system would be using the technology they were themselves creating.

The first Internet document describing electronic mail was probably RFC 196, published in 1971. It describes something called *A Mail Box Protocol*, a very rudimentary message transfer method using the predecessors of TCP/IP. This protocol was designed for the specific purpose of sending documents for remote printing. In those days it was not as common for people to use computers at interactive terminals as it is today, but the idea of electronically mailing documents was the same. The Mail Box Protocol was revised several times in 1971.

In the mid-1970s, work began to develop a more comprehensive method of implementing electronic mail on the fledgling Internet. The technique was originally described using a number of then-existing application-layer transfer protocols, including the [File Transfer Protocol \(FTP\)](#). In 1980 the *Mail Transfer Protocol (MTP)* was published in RFC 772. This was the first precursor of today's TCP/IP e-mail, and was defined using principles from the [Telnet](#) remote access protocol as well as FTP.

During the time that e-mail protocols were being developed in the 1970s, mail was being exchanged between host systems using a variety of different techniques. One of the most common used the *Unix-to-Unix Copy Protocol (UUCP)*, which was designed to allow files to be transferred between UNIX systems, moving them from one connected system to the next. UUCP was also used for communicating [Usenet](#) newsgroup articles and other files.

In 1981, the modern TCP/IP electronic mail era came into being with the definition of the *Simple Mail Transfer Protocol (SMTP)*. SMTP described in detail how mail could be moved directly or indirectly from one TCP/IP host to another without the need to use FTP or another file transfer method. [It has its own detailed history and discussion in this Guide](#). Other complementary specifications were created at around the same time, which formalized or defined other components and elements of the system. We'll explore these pieces of the puzzle in the next two topics.

Overview of the TCP/IP Electronic Mail System

One of the most important general concepts in the modern electronic mail system is that a distinction is made between protocols that deliver electronic mail between SMTP hosts on the internetwork, and those that let users access received mail on their local hosts. To continue our analogy, different protocols are used for sending mail between post offices, and for “home delivery”. As we'll see, this was done intentionally, to make it possible to send mail to users even if they are not connected to the Internet at the time mail was sent. This decoupling is critical as it enables *delayed* communication, where mail can be sent when the sender wants to transmit it, and received when the recipient wants to read it.

Over the years, the basic components defined in the early 1980s have not changed substantially, but how they are used has evolved and been improved. Early electronic mail delivery involved the use of route specifications by one SMTP host to dictate how mail was to be delivered through intermediate systems; today, the [Domain Name System](#) makes much of that obsolete, facilitating nearly immediate direct mail delivery in most cases. Early electronic mail supported only simple text, where we can now send graphical images, programs and other files in e-mail. Modern high-speed Internet connections and updated access protocols allow modern e-mail to be the realization of the ultimate goal of nearly instantaneous communication even across continents.



Key Concept: One of the most important TCP/IP applications is the internetworking equivalent of the real-world postal delivery system, commonly called *electronic mail* or *e-mail*. The history of e-mail goes back to the very earliest days of TCP/IP's development; today it is used by millions of people every day to send both simple and complex messages around the world. TCP/IP e-mail is not a single application, but rather a complete system that includes several protocols, software elements and components.

TCP/IP Electronic Mail Communication Overview: Message Composition, Submission, Delivery, Receipt, Processing and Access

TCP/IP electronic mail is implemented as a [complete system](#), with a number of different elements that perform different portions of the complete job of electronic mail communication. These included a standard message format, a specific syntax for recipient addressing, and protocols to both deliver mail and allow access to mailboxes from intermittently-connected TCP/IP clients.

To help set the groundwork for examining these components, I want to provide an overview of the complete end-to-end process of e-mail communication, so you can see how everything works. I will show the basic steps in simplified form, and continue the analogy to the regular mail system for comparison.

E-Mail Communication Process Steps

The modern TCP/IP e-mail communication process consists of the following five basic steps.

1. Mail Composition

A user begins the e-mail journey by creating an electronic mail message. The message contains two sections: the *header* and the *body*. The body of the message is the actual information to be communicated; the header contains data that describes the message and controls how it is delivered and processed. The message must be created so that it matches the [standard message format](#) for the e-mail system so that it can be processed. It must also specify the [e-mail addresses](#) of the intended recipients for the message.

By way of analogy to real mail, the body of the message is like a letter, and the header is like the envelope into which the letter is placed.

2. Mail Submission

As we'll see in greater detail in [the next topic](#), electronic mail is different from many other internetworking applications in that the sender and receiver of a message do not necessarily need to be connected to the network simultaneously, nor even continuously, to use it. The system is designed so that after composing the message, the user decides when to submit it to the electronic mail system so it can be delivered. This is done using the [Simple Mail Transfer Protocol \(SMTP\)](#).

This is analogous to dropping off an envelope at the post office, or to a postal worker picking up an envelope from a mailbox and carrying it to the local post office to insert into the mail delivery stream.

3. Mail Delivery

The electronic mail message is accepted by the sender's local SMTP system for delivery through the mail system to the destination user. Today, this is accomplished by performing a [Domain Name System \(DNS\)](#) lookup of the intended recipient's host system and establishing an SMTP connection to that system. SMTP also supports the ability to specify a sequence of SMTP servers through which a message must be passed to reach a destination. One way or the other, eventually the message arrives at the recipient's local SMTP system

This is like the transportation of the envelope through the postal system's internal "inter-network" of trucks, airplanes and other equipment to the intended recipient's local post office.

4. Mail Receipt and Processing

The local SMTP server accepts the e-mail message and processes it. It places the mail into the intended recipient's mail box, where it waits for the user to retrieve it.

In our physical analogy, this is the step where the recipient's local post office sorts mail coming in from the postal delivery system and puts the mail into individual post office boxes or bins for delivery.

5. Mail Access and Retrieval

The intended recipient periodically checks with its local SMTP server to see if any mail has arrived. If so, the recipient retrieves the mail, opens it and reads its content. This is done using not SMTP but a special [mail access protocol or method](#). To save time, the access protocol and client e-mail software may allow the user to scan the headers of received mail (such as the subject and sender's identity) to decide which mail messages to download.

This is the step where mail is physically picked up at the post office or delivered to the home.

Modifications to the General Communication Process

In some cases not all of these steps are performed. If a user is sending e-mail from a device that is already an SMTP server, then step #2 can be omitted; if the recipient is logged in to a device that is also an SMTP server, step #5 will be skipped, as the user can read mail directly on the server. Thus, in the simplest case all that occurs is composition, delivery and receipt; this occurs when one user of a dial-up UNIX host sends mail to another. In most cases, today, however, all five steps occur.



Key Concept: TCP/IP electronic mail communication normally involves a sequence of five steps, each of which is analogous to a portion of the journey taken by a regular letter through the postal system. First, e-mail is *composed* (written); second, it is *submitted* to the e-mail system; third, it is *delivered* to recipient's server; fourth, it is *received and processed*; and finally, fifth, it is *accessed and retrieved* by its recipient.

Again, this is simplified. I have, for example, omitted the step where the recipient notices that the mail is in fact an advertisement from a spammer for how he can "make money fast", eliminate debt or lose weight overnight, then mutters under his breath and deletes the message. Hey, I never said there were no **disadvantages** to electronic mail being fast and nearly free. ☺

TCP/IP Electronic Mail Message Communication Model and Device and Protocol Roles

The purpose of the electronic mail system as a whole is to accomplish the transmission of electronic mail messages from a user of a TCP/IP internetwork to one or more recipients. In order to accomplish this, a special method of communication is required that makes the electronic mail system quite different from that used by most other protocols. To understand what I mean by this, you need only recognize the difference in communication between sending a letter and making a phone call.

Most TCP/IP protocols are analogous to making a phone call in this respect: the sender and the receiver must both be on the network at the same time. You can't call someone and talk to them if they aren't around to answer the phone. (Yeah, yeah, answering machines and voice mail. Stop interrupting, will you? ☺) Most TCP/IP protocols are like this: to send a file using [FTP](#), for example, you must make a direct connection from the sender's machine to the recipient's machine. If the recipient's machine is not on the network at the exact time that sender's is, no communication is possible.

For electronic mail, this type of communication is simply unacceptable. Electronic mail is like its real-world counterpart; Joe wants to be able to put a message into the system at a time that is convenient for him, and Ellen wants to be able to receive Joe's mail at a time that works for her. For this to work, e-mail must use a “send and forget” model, just like real mail, where Joe drops the “envelope” into the e-mail system and it eventually gets to its destination.

This *decoupling* of the sender and receiver is critical to the design of the electronic mail system. This is especially true because many of the users of Internet electronic mail are not on the Internet all the time. Just as you wouldn't want real mail to be rejected if it arrived when you are not home, you don't want electronic mail to not be delivered if you are not on the Internet when it arrives. Similarly, you may not want to be connected to the Internet for the entire time it takes to write a message, especially if you have access to the Internet for only a limited amount of time each day.

Also critical to the entire electronic mail system is that idea that communication is between specific **users**, and not between particular machines. This makes e-mail inherently different than many other types of communication on TCP/IP internetworks. We'll see more of why this is important when we look at [e-mail addressing](#).

The Delayed Delivery Model and Device Roles

To allow the type of communication needed for electronic mail, the entire system is designed to facilitate the *delayed delivery* of e-mail messages from one user to another. To see how this works, let's look again at the example communication we discussed in [the previous topic](#), but this time, considering the roles of the different **devices** in the exchange (as shown in [Figure 301](#)):

-
- ④ **Sender's Client Host:** The sender of the mail composes an electronic mail message, generally using a mail client program on his or her local machine. The mail, once composed, is not immediately sent out over the Internet; it is held in a buffer area called a *spool*. This allows the user to be “detached” for the entire time that a number of outgoing messages are created. When the user is done, all of the messages can be sent at once.
 - ④ **Sender's Local SMTP Server:** When the user's mail is ready to be sent, he or she connects to the internetwork. The messages are then communicated to the user's designated local **SMTP** server, normally run by the user's Internet Service Provider (ISP). The mail is sent from the client machine to the local SMTP server using SMTP. (It is possible in some cases for the sender to be working directly on a device with a local SMTP server, in which case sending is simplified.)
 - ④ **Recipient's Local SMTP Server:** The sender's SMTP server sends the e-mail using SMTP to the recipient's local SMTP server over the Internetwork. There, the e-mail is placed into the recipient's incoming mailbox (*inbox*). This is comparable to the outgoing spool that existed on the sender's client machine. It allows the recipient to accumulate mail from many sources over a period of time, and retrieve them when it is convenient.

- ☉ **Recipient's Client Host:** In certain cases the recipient may access his or her mailboxes directly on the local SMTP server. More often, however, a mail access and retrieval protocol, such as POP3 or IMAP, is used to read the mail from the SMTP server and display it on the recipient's local machine. There, it is displayed using an e-mail client program, similar to the one the sender used to compose the message in the first place.

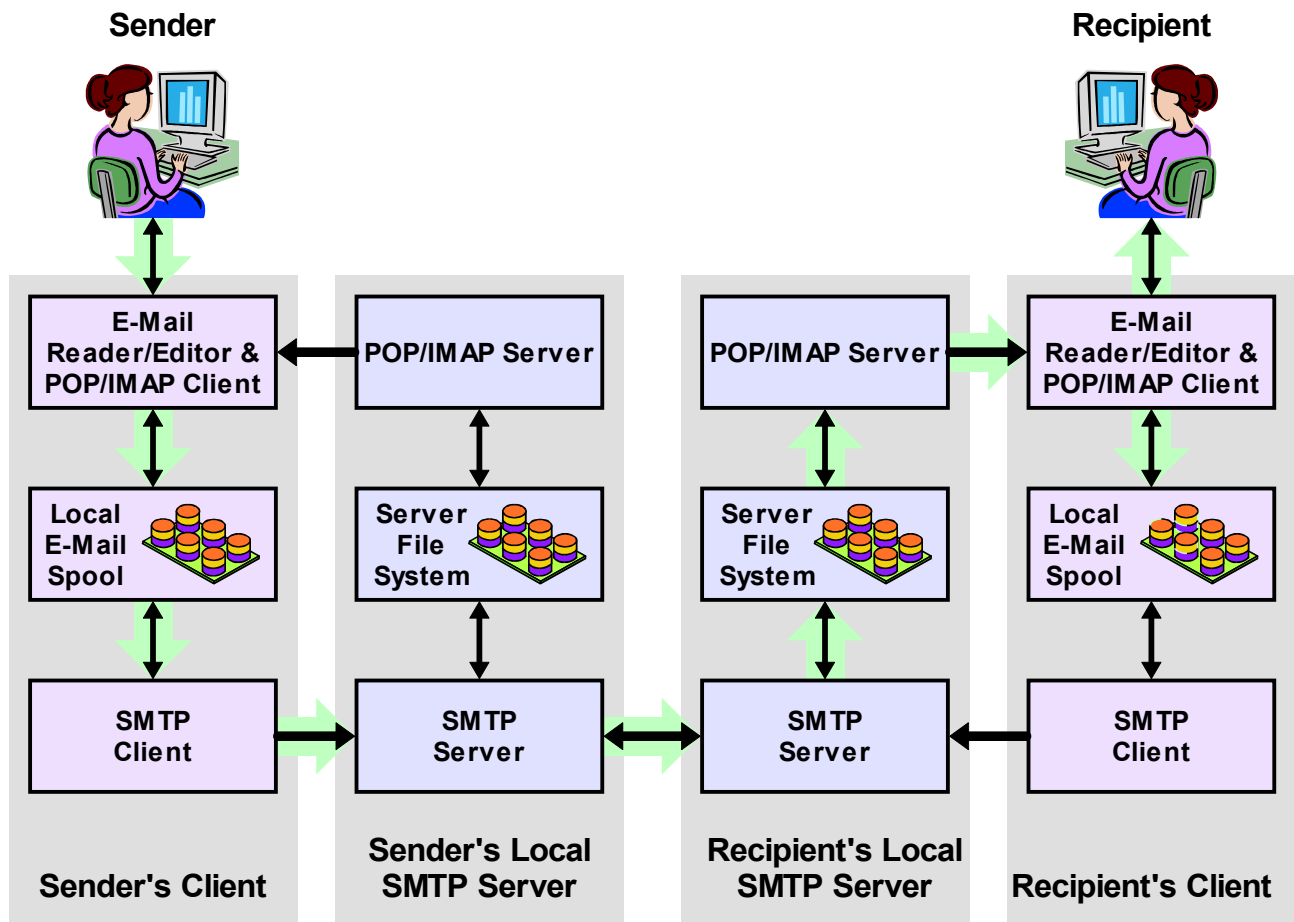

Figure 301: Electronic Mail (E-Mail) Communication Model

This diagram shows the four devices that are involved in a typical e-mail communication between two users. (Yes, they *are* identical twins, imagine that! ☺) Each device consists of a number of different elements, which communicate as indicated by the black arrows. Note the inherent asymmetry, because the method used to send an e-mail from a user is not the same as that used to retrieve it from the server. The large green arrows show a typical transaction: the sender composes mail and it goes to her local e-mail spool. It is sent to the sender's local SMTP server using SMTP, and then to the recipient's SMTP server, where it goes into that user's inbox. It is then retrieved, usually using a protocol such as POP or IMAP.

Protocol Roles In Electronic Mail Communication

You may have noticed that SMTP is used for most of this communication process. In fact, if the recipient uses a machine that runs SMTP software, which is common for those using dialup UNIX shell Internet access, the process of sending e-mail uses SMTP exclusively.

SMTP servers must, however, always be available on the Internet and ready to accept mail. Most people access the internetwork using devices that aren't always online or that don't run SMTP software. That is why the last step, mail access and retrieval, is usually required.

It might have been possible to define the electronic mail system so that this last step of communication was carried out using SMTP as well, which would mean the entire system used the same protocol. However, SMTP was tailored for the specific purpose of transporting and delivering e-mail, not for remote mailbox access. It made more sense to leave the function of mailbox access to dedicated, separate protocols. This not only allows these protocols to be tailored to the needs of e-mail recipients, but provides flexibility by giving users more than one option for how e-mail is retrieved. I discuss mail access protocols and methods in a [separate section of the Guide](#), highlighting the two most common protocols: the [Post Office Protocol \(POP\)](#) and the [Internet Message Access Protocol \(IMAP\)](#).

The three protocols discussed above—SMTP, POP3 and IMAP—get the “lead billing” on the TCP/IP electronic mail stage, but they rely on two other elements to play “supporting roles”. The first is a [method of addressing e-mail messages](#) to ensure that they arrive at their destinations. The second is the set of [message formats](#) used to encode messages and control how they are delivered and used. These don't usually get as much attention as they deserve, but they do here, as I have devoted the next two sections to them.



Key Concept: One of the critical requirements of an electronic mail system is that the sender and receiver of a message not be required to both be on the system at the time mail is sent. TCP/IP therefore uses a communication model with several devices that allow the sender and recipient to be *decoupled*. The sender's client device spools mail and moves it to the sender's local SMTP server when it is ready for transmission; the e-mail is then transmitted to the receiver's SMTP server using SMTP. The e-mail can remain on the recipient's server for an indefinite period of time. When the recipient is ready to read it, he or she retrieves it using one or more of a set of mail access protocols and methods, the two most popular of which are POP and IMAP.



TCP/IP Electronic Mail Addresses and Addressing

The entire concept of electronic mail is based on an analogy: the comparison of sending electronic messages to the sending of paper messages. The analogy works well because e-mail was indeed intended to be like regular mail, only with the advantages of the electronic era: speed and flexibility.

One of the many similarities between electronic and regular mail is the need for *addressing*. In order for a message to be delivered, it is necessary that the sender specify who the recipient is, and provide a reasonable amount of information to indicate how the recipient can be reached. In TCP/IP electronic mail, a standard *electronic mail address* format is used for this, and support is also provided for alternative addressing schemes that may be used in special cases.

In this section I describe how electronic mail messages are addressed. I begin with a discussion of standard electronic mail addressing in TCP/IP, and how those addresses are used to determine where e-mail should be sent. I then provide a brief discussion of historical and special e-mail addresses that you may encounter from time to time. I also discuss the use of e-mail address books (aliases) and how multiple recipients may be addressed, as well as providing an overview of electronic mailing lists, one of the earliest ways in which electronic group communication was implemented.

TCP/IP Electronic Mail Addressing and Address Resolution

All communication on an internetwork requires some way of specifying the identify of the intended recipient of the communication. Most application protocols, such as [FTP](#) and [HTTP](#) for example, use conventional TCP/IP constructs—[IP addresses](#) and [port numbers](#)—to specify the destination of information to be sent. The IP address normally identifies a particular host computer, and the port number a software process or application running on that computer.

Electronic mail, however, uses a very different model for communication than most applications. As we saw in our [discussion of the e-mail model](#), one element that sets e-mail apart from many other systems is that communication is *user-oriented*. E-mail is not sent from one machine to another the way a file is transferred using FTP. It is sent from one user to another. This is critical to the operation of the entire system; for one thing, it is what allows someone to retrieve e-mail that has been sent from any number of different client computers. This allows e-mail to be received even when traveling, for example.

Since e-mail messaging is user-based, it is necessary that the addressing scheme be user-based as well. We cannot use conventional IP addresses and ports, but need a distinct system that specifies two primary pieces of information: **who** the user is, and **where** the user is located. These are, of course, analogous to a name and address on a regular mail envelope.

The idea of a user name is relatively straight-forward, but identifying the location of the user is not. In regular mail, an address refers to a physical place. It would have been possible to define e-mail addresses in the same way: have it refer to the user's client machine.

However, recall the other important characteristic of e-mail delivery: it is *indirect*, and based on the concept of a user's local SMTP server holding received messages until they can be retrieved. The machine that the user employs to access his or her e-mail may not even routinely be on the Internet, and it may thus not be easy to identify it. And again, we want a user to be able to access mail from multiple machines.

For all of these reasons, we want addresses to identify *not* the user's specific location at any particular time, but the place where the user's permanent mailbox lives. This is on the user's SMTP server, which is permanently connected to the Internet.

Standard DNS-Based E-Mail Addresses

In TCP/IP, the system used for identifying servers (and other machines) is the *Domain Name System (DNS)*. DNS is a big system and is described in [its own large section in this Guide](#); I would refer you to it if you want to learn more. For our purposes, what is important is that in DNS, all devices on the Internet are arranged into a [device naming hierarchy](#), and any device can be identified using a *domain name* consisting of a series of text labels separated by dots.

So, the complete TCP/IP address consists of two components: a user name specification and a domain name specification. The two are connected together using the special “at” symbol (“@”) to form the TCP/IP e-mail address syntax that almost all of us are familiar with today:

`<username>@<domainname>`

The format of `<domainname>` follows the [syntax rules of DNS](#), containing only numbers and digits for each label, and periods to separate the labels. The format of `<username>` is slightly less restrictive, allowing the use of special characters such as the underscore (“_”). Other special characters and spaces are also allowed in the `<username>` if they are surrounded by quotes (or otherwise marked as being part the name, such as through the use of an escape character.) Domain names are case-insensitive; user names may be case-sensitive, depending on the system.

So, an example of a valid e-mail address might be the following address I used when I was in school many years ago:

`cmk@athena.mit.edu`

Where “cmk” is my user name (my initials) and the “athena.mit.edu” is the name of the host where I was receiving mail. “athena” is a particular system at MIT (“mit”), which is an educational institution, and so uses the “.edu” [top-level domain](#).

URL E-Mail Address Specification

It is also possible to specify an e-mail address using an Internet-standard [Uniform Resource Locator \(URL\)](#). This allows a link to be embedded in a hypertext (Web) document that when clicked, invokes an e-mail client to send mail to a user. E-mail URLs are created by preceding the address by the special [URL scheme](#) string “mailto:”, like this:

mailto:cmk@athena.mit.edu

The Special Requirements of E-Mail Addresses

Having e-mail addressing refer to the user's local SMTP server provides a great deal of flexibility compared to having addresses mention a specific client computer. But it doesn't provide enough flexibility to handle various situations:

- ☉ An organization may want to use “generic” addresses that do not specify the name of the SMTP server to handle mail. The reason is that this requires people sending them mail to know the name of that server. For example, if someone knew my real name and that I was at MIT, it would be easier for them to remember my old e-mail address as “cmk@mit.edu” than “cmk@athena.mit.edu”.
- ☉ An administrator may change which machines handle mail over a period of time. This would mean all the users's e-mail addresses would have to change— and most of us know what a pain *that* is. For example, if I moved from the “athena” machine to the “jabberwocky” machine, my old address would have needed to change to “cmk@jabberwocky.mit.edu”. But if it were just “cmk@mit.edu” the change would not affect me.
- ☉ In larger organizations, it might be desirable to have multiple servers share the load of handling incoming mail.

The Mail Exchange (MX) DNS Record

To address all of these requirements, the DNS system includes a feature that was specifically designed to support electronic mail addressing. A special *mail exchange (MX)* record can be set up that specifies which SMTP server should be used for mail coming in to a particular domain name. If properly configured, this allows considerable flexibility to handle the cases I described above and more. For more details, [please see the description of the MX record and DNS electronic mail support](#).

For example, I am the owner of the “pcguide.com” domain name. E-mail can be sent to me at “pcguide.com”, but it is not actually stored on any server by that name. It is redirected to the real server where my inbox is located. This allows me to handle all incoming mail to “pcguide.com” regardless of where my mailbox is actually located.

DNS is also significant in that its “MX” resource records eliminated the need to “relay” e-mail from one SMTP server to the next to deliver it. In modern TCP/IP it is possible to send e-mail directly from the sender's SMTP server to the recipient's, making communication faster and more efficient. [See the section devoted to SMTP for details](#).



Key Concept: Some form of addressing is required for all network communication; since electronic mail is *user-oriented*, e-mail addresses are based on users as well. In modern TCP/IP e-mail, standard addresses consist of a *user name*, which specifies who the recipient is, and a *domain name*, which specifies the DNS domain where the user is located. A special DNS *mail exchange (MX)* record is set up for each domain that accepts e-mail, so a sending SMTP server can determine what SMTP server it should use to send mail to a particular recipient.

TCP/IP Historical and Special Electronic Mail Addressing

TCP/IP electronic mail has been so successful that it is arguably the most important worldwide standard for electronic messaging. The widespread acceptance of e-mail is tied inextricably to that of TCP/IP and the Internet as a whole. Since most organizations want to be part of the Internet, they connect to it and use its technologies, including the [Domain Name System](#) that is the basis for TCP/IP e-mail addresses. In turn, the use of simple DNS-style e-mail addresses (“user@domain”) encourages further use of e-mail because people find it conceptually easy to decide how to send messages.

TCP/IP is not, however, the only electronic mail system around. Over the years several other networks have developed e-mail systems. Due to the fact that the Internet is the largest internetwork in the world, TCP/IP e-mail has often been used as a “clearing house” of sorts to link together some of these different e-mail mechanism. This is called *gatewaying*, and allows someone using a non-SMTP e-mail system to interact with someone using TCP/IP, and vice-versa. Gatewaying is complex, and one of the reasons is that e-mail systems use different ways of addressing mail. Let's take a look at a couple of these systems and how they interact with TCP/IP.

FidoNet Addressing

One of the earliest independent e-mail systems was the *FidoNet*, which has been around for a long time and is still in use today. FidoNet is a worldwide network connected using modems and proprietary protocols; it is in essence, a “competitor” to the global TCP/IP Internet. I put “competitor” in quotes because the two are not really comparable in terms of number of users and the kinds of applications they support, but they are similar in overall objectives: worldwide electronic communication.

FidoNet users are identified using four numbers that specify the FidoNet *zone*, *net*, *node* and *point (connection point)*. These addressing elements are used for sending mail on this system, which again is completely distinct from TCP/IP. However, to allow communication between TCP/IP and FidoNet, the FidoNet administrators have set up a gateway system that allows mail to be sent to FidoNet using TCP/IP style domain names. This style of mapping was also used by other systems with proprietary mail address formats to allow them to interface with the Internet.

For example, if a user was on machine 4, node 205, net 141, zone 1 (North America), the FidoNet address would be 1:141/205:4. The equivalent domain name would be p4.f205.n141.z1.fidonet.org, and could be used for TCP/IP-style “user@domain” addressing.

UUCP-Style Addressing

An older address style commonly associated with e-mail was the “UUCP style” address. The *Unix-to-Unix Copy Protocol (UUCP)* was commonly used years ago to route mail before SMTP became widely deployed (again, it is still used, just not as much as before). The addresses in this system are specified as a path of hosts separated by exclamation marks (“!”). The path dictates the route that mail takes to get to a particular user, passing through a series of intermediate machines running UUCP. For example, if mail to “joe” at the host “joesplace” had to go through three hosts “host1”, “host2” and “host3”, the address would be:

host1!host2!host3!joesplace!joe

Since the slang term for an exclamation mark is “bang”, this came to be called *bang path* notation.

The use of UUCP style notation was sometimes mixed with TCP/IP style domain name address notation when DNS came into use. So you might have seen something like “host1!user@domain”. There was some confusion in how exactly to interpret such an address: does it mean to send mail first to “host1” and then to “user@domain”? Or does it mean to first send it to the “domain” which then goes to “user” at “host1”? There was no universal answer to this. The problem was mostly resolved both by the decrease in use of UUCP and the move on the part of UUCP systems to TCP/IP style domain name addressing.

Addressing for Gatewaying

Finally, you may encounter e-mail addresses that appear like multiple TCP/IP addresses that have been nested using unusual punctuation. For example, you may see something that looks like this:

user%domain1.com@subdomain.domain2.edu

This is a way of addressing sometimes seen when e-mail gateways are used; it will cause the mail to be sent to “user%domain1.com” at “subdomain.domain2.edu”. The address then is interpreted as “user@domain1.com”. However, again, not all systems are guaranteed to interpret this the same way.

E-mail gatewaying is not a simple matter in general, and as you can see, one reason is the use of different e-mail address styles and the problems of consistency in how complex “hybrid” addresses are interpreted, as discussed above. However, as the Internet expands

and TCP/IP becomes more widespread, it is becoming less and less common to see these older, special address formats in use. They are becoming more and more a “historical curiosity” (unless you happen to use one of them!)

TCP/IP Electronic Mail Aliases / Address Books, Multiple Recipient Addressing and Electronic Mailing Lists

Electronic mail is analogous to regular mail, but superior to it due to two main advantages of digital and electronic communication. One of these is *speed*, which is why modern Internet users have come up with the slang term “snail mail” to refer to the regular postal service. ☺ But the other is also essential: *flexibility*. E-mail allows you to send messages easily in ways that would be cumbersome with regular mail. And one of the ways this flexibility can be seen is in addressing.

The first way that e-mail addressing is flexible is that most e-mail clients support advanced features that allow users to specify the identity of recipients in convenient ways. While TCP/IP addressing really is fairly straight-forward, remembering the addresses of everyone you know is difficult. In the real world we use address books to help us remember addresses. With e-mail, we can do the same, by allowing e-mail software to associate a name with an e-mail address. This is usually done in one of two ways.

E-Mail Address Aliases

In “old-fashioned” text-based e-mail such as that used on many UNIX systems, name and address association is performed using *aliases*. These are short forms for e-mail addresses that save typing. For example, my wife's name is Robyn and I often send her e-mail, but I'm too lazy to type in her address all the time. So I have defined an alias for her in my e-mail program called simply “r”. I enter the mail command and specify the alias “r” as the intended recipient, and it expands it for me. (Yeah, I could have used “robyn” but hey, I'm *really* lazy. ☺)

Electronic Address Books

In modern graphical e-mail systems, aliases aren't used. Instead, an *electronic address book* is usually implemented, which is of course the equivalent of the paper address book. The difference is that there is no manual copying; you just choose the name from the list using your mouse; nothing could be simpler unless the system could somehow read your mind.

Specifying Multiple Recipients

Another advantage of electronic mail addressing is that it allows the easy specification of multiple recipients. With paper mail, sending a message to ten people means you need ten copies of the message, ten envelopes and also—ten stamps. With e-mail, you just list the recipient addresses separated by a comma in the recipient list:

```
<user1@domain1>,<user2@domain2>,<user3@domain3>...
```

A separate copy is mailed to each recipient, easy as can be. Of course, aliases and/or address books can be used to specify each recipient here as well, making this even simpler.

Since e-mail makes it so easy for one person to send information to a set of others, so-called *one-to-many* messaging, it was also one of the first ways in which electronic group communication was implemented. Prior to e-mail, sharing information in a group setting either required a face-to-face meeting, or a telephone conference call. In both cases, all parties have to be present simultaneously, and there is a cost involved, especially when the parties are geographically distant.

With e-mail, a group of individuals can share information without needing to meet or even be available at the same time. Suppose there is a group with four individuals: persons *A*, *B*, *C* and *D*. Person *A* has a proposal that he wants discussed. He sends it to *B*, *C* and *D*. Each recipient will read it at a time convenient for him or her. Each can then reply back to the group. For example, *D* might have a comment on the proposal, so she just sends it to *A*, *B* and *C*. Most e-mail clients include a *group reply* feature for this purpose.

Mailing Lists

In larger groups, communication by simply writing out the addresses of each recipient becomes cumbersome. Instead, a *mailing list* is used. The list is created by an individual termed the *list owner* and contains the electronic mail addresses of all the members of the group. Then, a special *list address* is created. This address looks and functions just like a regular e-mail address. However, when anyone sends mail to this special address, it is not simply deposited into a mailbox. It is instead intercepted by special software that processes the message and sends it out automatically to all recipients on the list. Any recipient can reply back to the list address and all members will receive the reply.

There are many thousands of mailing lists on the Internet, covering every subject imaginable. Each list differs in a number of regards, including the following:

- ☉ **Implementation:** Usually some sort of special software is used to allow the list owner to manage it, add and remove users and set parameters that control how the list operates. These programs are commonly called *robots* or *listservs* (*list servers*). One of the more common ones is named *Majordomo*. There are also now mailing lists that are actually implemented and managed using the [World Wide Web](#). (The line between Internet applications continues to get more and more blurry...)
- ☉ **Subscription Rules and Technique:** Some mailing lists are open to anyone who wishes to join, while others are “by invitation only”. Most allow a new subscriber to join automatically using software, others require the list owner to add new members.
- ☉ **Management Method and Style:** The list owner decides what is acceptable for discussion on the list. Some lists are *moderated*, meaning that all submissions to the list must be approved by the list owner before they are sent to list members. Some lists allow mail to the list from non-members, some do not.
- ☉ **“Culture”:** Like all groups, groups of people on mailing lists have their own “culture”, interesting “personalities” and so forth. New members of a list are often encouraged to read the list and not send to it for a while until they become accustomed to it and how it works. This is similar to the acclimation process for Usenet “newbies”.

-
- **Special Features:** Some lists support special features, such as the ability to subscribe in *digest mode* (where messages are collected into large digests to cut down on the number of individual messages sent) or to access messages on the Web.



Key Concept: One of the many benefits of electronic mail is that it is easy to send a message to many people at once, simply by specifying several recipient addresses. This permits easy and simple *group communication*, because each recipient can then do a group reply to send a response to each of the people who were sent the original message. Electronic *mailing lists* provide a more formalized way for groups to exchange ideas and information; there are many thousands of such lists in existence on the Internet.

There are many other ways for groups to share information today, such as World Wide Web bulletin boards, [Usenet newsgroups](#), [Internet Relay Chat](#) and so forth. Some of these have a lot of features that make mailing lists seem “unsophisticated” by comparison. Despite this, electronic mailing lists are still very popular, largely because e-mail is the most universal Internet communication method, and one of the easiest to use.



TCP/IP Electronic Mail Message Formats and Message Processing: RFC 822 and MIME

The advantages of using computers for communication are obvious, but there are also some limitations that are imposed by the use of computer technology. When I compare electronic mail to regular mail, I always point out that e-mail is much faster and more flexible in how it can be delivered, and this is true. An electronic mail message can reach its destination in seconds, where a conventional letter would take days.

But one drawback computers have is that they are not very *adaptable* in figuring out how to understand messages. Consider that anyone can put any type of letter, memorandum or other communication in an envelope and send it to you, and assuming you know the language it is written in, you can open the envelope and understand it. You can automatically figure out how to deal with the date being in an unusual place in the letter, or your name appearing at the top compared to the bottom, or the body of the message being structured in different ways. You can read notes that are typed or hand-written; in pen, pencil or crayon; as long as the letters are decipherable, you can understand what is being said.

Computers are not very good at this at all. And it is for that reason that e-mail systems must rely on standard *message formats* to ensure that all messages have the same form and structure. This then makes it possible for all devices in the electronic mail system are able to read and understand each others' messages, to enable TCP/IP e-mail to work on many different types of computers.

In this section, I describe the two formats used for TCP/IP electronic mail messages, in two subsections. The first describes the main TCP/IP electronic mail standard, which is called the RFC 822 format after the standard that defines it. The second describes the Multi-purpose Internet Mail Extensions (MIME) standard, which greatly expands the ability of electronic mail to support the communication of different types of information, by defining methods of encoding various media and non-English language text into the standard RFC 822 format.

TCP/IP Electronic Mail Standard Message Format: RFC 822

One of the most astute observations I have read about internetworking applications is that their usefulness is proportional to the number of people who use them. TCP/IP e-mail is a great example: it is a powerful communication method in large part because almost everyone with a computer today participates in the system. The more people who sign on to use e-mail, the more powerful it becomes.

The creators of TCP/IP email realized that people who use the system would employ many different types of hardware and software. To ensure that everyone was able to understand all e-mail messages, regardless of who sent them, they specified a common message format for electronic mail messages. This format doesn't have an official fancy name; it is simply known by the name of the standard that defines it: the *RFC 822* message format.

In this section I describe the RFC 822 message format, which forms the basis for electronic mail message transfer in TCP/IP. I begin with an overview of the format and the general structure of messages, and some of the overall rules used to format RFC 822 messages. I then describe the many headers used in RFC 822 e-mail messages, and how they are arranged into groups. I conclude with a brief look at how RFC 822 messages are processed and their contents interpreted.



Related Information: This section may make certain references to [the one on SMTP](#), but was designed so that you could read it prior to reading about SMTP without getting confused. Well, I tried, anyway. ☺

TCP/IP Electronic Mail RFC 822 Standard Message Format Overview, Structure and General Formatting Rules

The primary protocol for delivering electronic mail is the [Simple Mail Transfer Protocol \(SMTP\)](#). For this reason, the message format used for TCP/IP e-mail could be considered SMTP's "protocol message format", not unlike the special message formats discussed for other protocols, such as IP and TCP. However, the TCP/IP e-mail message format is used not only by SMTP but by all protocols and applications that deal with electronic mail. This includes the [mail access protocols](#) POP3 and IMAP, as well as others. It was also intended to potentially be usable by other non-TCP/IP mail delivery protocols.

Perhaps for this reason, the TCP/IP e-mail format was not specified as part of the SMTP itself, RFC 821, but rather in a companion document: RFC 822. Both were published in 1982. No official fancy name was given to this message format, and as a result the format became known by the name of the standard itself: the *RFC 822 message format*.

Development of the RFC 822 Message Format Standard

The history of the message format used in TCP/IP goes back long before 1982, of course. It was originally defined as the format for passing text messages on the Internet's precursor, the ARPAnet, in the early 1970s. Over time the format was refined several times, leading to

the publication, in 1977, of the important e-mail standard RFC 733 (*Standard for the Format of ARPA Network Text Messages*). RFC 822 later streamlined the contents of RFC 733, removing some of the features described in the earlier standard that failed to gain acceptance, and simplifying the specification.

In 2001, both SMTP and the RFC 822 message format were revised; SMTP is now described in RFC 2821 and the message format in RFC 2822. This newer standard makes relatively small changes to the RFC 822 message format to reflect modern use of TCP/IP e-mail. Even though RFC 2822 is the current standard, the original name is still the one most commonly used. I will respect that convention in this discussion, describing the message format based on RFC 2822 while still calling it the “RFC 822” message format.

The RFC 822 format describes the form, structure and content of TCP/IP electronic mail messages. It is, as I said, analogous to the message formats used for other protocols in TCP/IP. Like those other formats, the RFC 822 format can be logically divided into two main sections: the *message header*, which contains important control and descriptive information, and the *message body* or *payload*, which carries the data.

Overview of RFC 822 Messages

Where RFC 822 differs from the field formats of other protocols is in expression. Most TCP/IP protocols encode header information into a compact set of bytes that are read and understood based on their location in the message and the semantic meaning assigned to them. Consider the Internet Protocol, for example. The 9th byte of every IP datagram is the *Time To Live (TTL)* field, which is encoded as a value from 0 to 255. A device reading an IP datagram simply knows that byte number 9 contains the *TTL* value. If it sees the binary value “00010011” there, it knows the *TTL* value for this datagram is the decimal value 19.

In contrast, RFC 822 messages do not use a binary format. They are entirely comprised of lines of regular ASCII text (as used in the United States, called *US-ASCII* by the standard), even the headers. Each line ends with an ASCII *carriage return (CR)* character, followed by a *line feed (LF)* character; the combination is collectively termed “CRLF”. Each line of text should be 78 characters or less (not including the terminating “CRLF”) and must not be more than 998 characters (again, excluding the “CRLF”). Also, the characters CR and LF must not appear by themselves within the text.

The RFC 822 message begins with a set of lines of text that collectively comprise the message header. Each *header field* is expressed in the following form, in text:

<header name>: <header value>

So, for example, if there were a *Time To Live* field in RFC 822 messages (there isn't, of course, as that concept has no meaning to e-mail) and a value of 19 needed to be expressed, the header field would appear like this:

Time To Live: 19

This expressing of all fields as simple text means each header takes up more space in each message; the string “Time To Live: 19” takes up 18 bytes including the terminating “CRLF”, where the binary-encoded *Time To Live* field in the IP header takes only a single byte. What we gain from this are two important benefits. First, any user can easily check the headers and immediately understand what headers are present and what their values are, which makes RFC 822 messages very *readable*. Second, since each header is explicitly labeled, RFC 822 messages can vary in terms of the number of headers they contain, and even in what order they appear, making them *flexible*.

General Structure

The RFC 822 message always starts with a set of header fields as described above; [the next topic](#) describes them in more detail. After all the headers, an empty line must occur. This consists simply of the characters “CRLF” by themselves, immediately following the “CRLF” at the end of the final header field line. Seeing two “CRLF” character pairs in sequence tells the device reading the message that the end of the headers have been reached. All the remaining lines are considered the body of the message. Like the header lines, body lines are comprised of ASCII text and must be no more than 998 characters, with 78 characters or less recommended (for easier reading on standard 80-character terminal displays).

Since both the header and body of e-mail messages are simply ASCII text, this means the entire message is just a text file. This makes these messages very readable, as I said above, and also quite easy to create. One can use a simple text editor to create a complete electronic mail message, including headers, and can read it with a simple text display utility. This contributes to e-mail's universal appeal.

The drawback is that the decision to make messages entirely ASCII means there is no native support in RFC 822 messages for anything that requires more complex structuring, or that cannot be expressed using the small number of ASCII characters. One cannot express pictures, or binary files, spreadsheets, sound clips and so forth directly using ASCII. Also, the use of ASCII makes RFC 822 well-suited to expressing messages in English, but not in many other languages, which use characters that ASCII cannot represent. All of these limitations eventually prompted the creation of the enhanced [MIME message format](#).



Key Concept: To ensure that every device on a TCP/IP internetwork can read e-mail sent by every other device, all messages are required to adhere to a specific structure. The standard that first specified the form of modern TCP/IP e-mail messages was RFC 822, and as a result, this is now called the *RFC 822 message format*. An RFC 822 message consist of a set of *message headers* and a *message body*, which are separated by a blank line. RFC 822 messages must contain only plain ASCII text characters; each line must be no more than 1000 characters in length, and the last two characters must be the ASCII characters “CR” and “LF” to mark the end of the line.

TCP/IP Electronic Mail RFC 822 Standard Message Format Header Field Definitions and Groups

The [RFC 822 message format](#) describes the structure and content of TCP/IP e-mail messages. The structure is intentionally designed to be very simple and easy to both create and understand. Each message begins with a set of headers that describe the message and its contents. An empty line marks the end of the headers, and then the message body follows.

The message body contains the actual text that the sender is trying to communicate to the recipient(s), while the message header contains various types of information that serve various purposes. The headers help control how the message is processed, by specifying who the recipients are, describing the contents of the message, and providing information to a recipient of a message about processing done on the message as it was delivered.

Header Field Structure

Each header field follows the simple text structure we saw in the preceding topic:

```
<header name>: <header value>
```

The <header name> is of course the name of the header, and the <header value> is the value associated with that header, which depends on the header type. Like all RFC 822 lines, headers must be no more than 998 characters long and are recommended to be no more than 78 characters in length, for easier readability. The RFC 822 and 2822 standards support a special syntax for allowing headers to be “folded” onto multiple lines if they are very lengthy. This is done by simply continuing a header value onto a new line, which *must* begin with at least one “white space” character, such as a space or <Tab> character, like this:

```
<header name>: <header value part 1>
<white space> <header value part 2>
<white space> <header value part 3>
...
```

The <Tab> character is most often used for this purpose. So, for example, if we wanted to specify a large number of recipients for a message, we could do it as follows:

```
To: person1@domain1.org, person2@domain2.com,
    person3@domain3.net, person4@domain4.edu
```

Header Field Groups

The RFC 822 message format specifies many types of headers that can be included in e-mail messages. A small number of headers are *mandatory*, meaning they must be included in all messages. Some are not mandatory but are usually present, because they are fundamental to describing the message. Others are optional and are included only when needed.

To help organize the many headers, the RFC 2822 standard categorizes them into header field groups (as did RFC 822, though the groups are a little different in the older standard):

- ☉ **Origination Date Field:** Specifies the date and time that the message was made ready for delivery; see below for details. (This field is in its own group for reasons that are unclear to me; perhaps just because it is important.)
- ☉ **Originator Fields:** Contain information about the sender of the message.
- ☉ **Destination Address Fields:** Specify the recipient(s) of the message, which may be in one of three different recipient classes.
- ☉ **Identification Fields:** Contain information to help identify the message.
- ☉ **Informational Fields:** Contain optional information to help make more clear to the recipient what the message is about.
- ☉ **Resent Fields:** Used to preserve the original originator, destination and other fields when a message is resent.
- ☉ **Trace Fields:** Used to show the path taken by mail as it was transported.

In addition, the format allows other, user-defined fields to be specified, as long as they correspond to the standard “<header name>: <header value>” syntax. This can be used to provide additional information of various sorts. For example, sometimes the e-mail client software will include a header line indicating the name and version of the software used to compose and send the message. We'll also see that [MIME uses new header lines](#) to encode information about MIME messages.



Key Concept: Each RFC 822 message begins with a set of *headers* that carry essential information about the message. These headers are used to manage how the message is processed and interpreted, and also describe the contents of the message body. Each header consists of a *header name* and a *header value*. There are over a dozen different standard RFC 822 headers, which are organized into groups; it is also possible for customized user headers to be defined.

Common Header Field Groups and Header Fields

Table 241 describes the header fields in TCP/IP e-mail messages and how they are used:

Table 241: RFC 822 Electronic Mail Header Field Groups and Fields (Page 1 of 3)

Field Group	Field Name	Appearance	Number of Occurrences Per Message	Description
Origination Date	<i>Date:</i>	Mandatory	1	Indicates the date and time that the message was made available for delivery by the mail transport system. This is commonly the date/time that the user tells his or her e-mail client to send the message.
Originator Fields	<i>From:</i>	Mandatory	1	The e-mail address of the user sending the message. This should be the person who was the source of the message itself.
	<i>Sender:</i>	Optional	1	The e-mail address of the person who is sending the electronic mail, if different from the message originator. For example, if person <i>B</i> is sending an e-mail containing a message from person <i>A</i> on <i>A</i> 's behalf, person <i>A</i> 's address goes in the <i>From:</i> header and person <i>B</i> 's in the <i>Sender:</i> header. If the originator and the sender are the same (which is commonly the case), this field is not present.
	<i>Reply-To:</i>	Optional	1	Used to tell the recipient of this message the address the originator would like the recipient to use for replies. If absent, replies are normally sent back to the <i>From:</i> address.

Table 241: RFC 822 Electronic Mail Header Field Groups and Fields (Page 2 of 3)

Field Group	Field Name	Appearance	Number of Occurrences Per Message	Description
Destination Address Field	To:	Normally present	1	A list of primary recipients of the message.
	Cc:	Optional	1	A list of recipients to receive a “copy” of the message (“cc” stands for “carbon copy”, as used in old typewriters). There is no technical difference between how a message is sent to someone listed in the Cc: header and someone in the To: header. The difference is only semantic, in how the recipient interprets the message. Someone in the To: list is usually the person who is the direct object of the message, while someone in the Cc: list is being copied on the message for informational purposes.
	Bcc:	Optional	1	Contains a list of recipients to receive a “blind carbon copy”. These people receive a copy of the message without other recipients knowing they have received it. For example, if X is specified in the To: line, Y is in the Cc: line, and Z is in the Bcc: line, all three would get a copy of the message, but X and Y would not know Z had received a copy. This is done either by removing the Bcc: line before message delivery or altering its contents.
Identification Fields	Message-ID:	Should be present	1	Provides a unique code for identifying a message; normally generated when a message is sent.
	In-Reply-To:	Optional, normally present for replies	1	When a message is sent in reply to another, the Message-ID: field of the original message is specified in this field, to tell the recipient of the reply what original message the reply pertains to.
	References:	Optional	1	Identifies other documents related to this message, such as other e-mail messages.

Table 241: RFC 822 Electronic Mail Header Field Groups and Fields (Page 3 of 3)

Field Group	Field Name	Appearance	Number of Occurrences Per Message	Description
Informational Fields	Subject:	Normally present	1	Describes the subject or topic of the message.
	Comments:	Optional	Unlimited	Contains summarized comments about the message.
	Keywords:	Optional	Unlimited	Contains a list of comma-separated keywords that may be of use to the recipient. This may be used optionally when searching for messages on a particular subject matter.
Resent Fields	Resent-Date: Resent-From: Resent-Sender: Resent-To: Resent-Cc: Resent-Bcc: Resent-Message-ID:	Each time a message is resent, a resent block is required	For each resent block, Resent-Date: and Resent-Sender: are required; the others are optional	These are special fields used only when a message is re-sent by the original recipient to someone else, a process called <i>forwarding</i> . For example, person X may send a message to Y, who forwards it to Z. In that case, the original <i>Date:</i> , <i>From:</i> and other headers are as they were when X sent the message. The <i>Resent-Date:</i> , <i>Resent-From:</i> and other “resent” headers are used to indicate the date, originator, recipient and other characteristics of the re-sent message.
Trace Fields	Received: Return-Path:	Inserted by e-mail system	Unlimited	These fields are inserted by computers as they process a message and transport it from the originator to the recipient. They can be used to trace the path a message took through the electronic mail system.

TCP/IP Electronic Mail RFC 822 Standard Message Format Processing and Interpretation

The standards that define SMTP describe the protocol as being responsible for transporting *mail objects*. A mail object is described as consisting of two components: a *message* and an *envelope*. The envelope contains all the information necessary to accomplish transport of the message; the message is everything in the e-mail message we have seen in the last two topics, including both message header and body.

The distinction between these is important technically. Just as the postal service only looks at the envelope and not its contents in determining what to do with a letter—no wise-cracks, please! ☺—SMTP likewise only looks at the envelope in deciding how to send a message. It does not rely on the information in the actual message itself for basic transport purposes.

So technically, the envelope is not the same as the message headers. However, as you can tell by looking at [the list of e-mail headers](#), each message includes the recipients and other information needed for mail transport anyway. For this reason, it is typical for an e-mail message to be specified with sufficient header information that it can be considered enough by itself to accomplish its own delivery. E-mail software can process and interpret the message to construct the necessary “envelope” for SMTP to transport the message to its destination mailbox(es). The distinction between an e-mail message and its envelope is discussed in more detail in [the topic describing SMTP mail transfers](#).

RFC 822 Message Processing Sequence

The processing of RFC 822 messages is relatively straight-forward, due again to the simple RFC 822 message format. The creation of the complete e-mail message begins with the creation of a message body and certain headers by the user creating the message. Whenever a message is “handled” by a software program, the headers are examined so the program can determine what to do with it. Additional headers are also added and changed as needed.

The following is the sequence of events that occur in the “lifetime” of a message's headers.

Composition

The human composer of the message writes the message body, and also tells the e-mail client program the values to use for certain important header fields. These include the intended recipients, the message subject and other informational fields, and certain optional headers such as the *Reply-To* field.

Sender Client Processing

The e-mail client processes the message, puts the information the human provided into the appropriate header form and creates the initial e-mail message. At this time, it inserts certain headers into the message, such as the origination date. The client also parses the intended recipient list to create the envelope for transmission of the message using SMTP.

SMTP Server Processing

SMTP servers do not pay attention to most of the fields in a message as they forward it. They will, however, add certain headers, especially trace headers such as *Received* and *Return-Path*, as they transport the message. These are generally prepended to the beginning of the message in order to ensure that existing headers are not rearranged or modified.

Note however that when [gatewaying](#) is done between e-mail systems, certain headers must actually be changed, to ensure that the message is compatible with non-TCP/IP e-mail software.

Recipient Client Processing

When the message arrives at its destination, the recipient's SMTP server may add headers to indicate the date and time the message was received.

Recipient Access

When the recipient of a message uses client software, optionally via a mail access protocol such as POP3 or IMAP, the software analyzes each message in the mailbox. This enables the software to display the messages in a way meaningful to the human user, and may also permit the selection of particular messages to be retrieved.

For example, most of us like to see a summary list of newly-received mail, showing the originator, message subject and the date and time the message was received, so we can decide which mail we want to read first, what mail to defer to a later time, and what to just delete without reading (spam spam spam ... ☺)



TCP/IP Enhanced Electronic Mail Message Format: Multipurpose Internet Mail Extensions (MIME)

The [RFC 822 e-mail message format](#) is the standard for the exchange of electronic mail in TCP/IP internetworks. Its use of simple ASCII text makes it easy to create, process and read e-mail messages, which has contributed to the success of e-mail as a worldwide communication method.

Unfortunately, while ASCII text is great for writing simple memorandums and other short messages, it provides no flexibility to support other types of communication. To allow e-mail to carry multimedia information, arbitrary files, and messages in languages using character sets other than ASCII, the *Multipurpose Internet Mail Extensions (MIME)* standard was created.

In this section I describe MIME and how it is used for modern e-mail messaging. I begin with an overview of MIME and discussion of its history and the standards that define it. I describe the two overall MIME message structures and provide a summary of the important MIME-specific headers. I then explain the important MIME *Content-Type* header in more detail, and discuss MIME discrete media types, subtypes and parameters. I discuss the more complex MIME multipart and encapsulated message structures, and then the different methods by which data can be encoded into MIME message bodies. I conclude with the special MIME extension to allow support for non-ASCII characters in ordinary e-mail headers.



Background Information: MIME is a message format that augments the basic RFC 822 message format, rather than replacing it. This section assumes that you have basic familiarity with [the RFC 822 format](#) and the more important [e-mail message headers](#).



Note: While MIME was developed specifically for mail, its encoding and data representation methods have proven so useful that it has been adopted by other application protocols as well. One of the best known of these is the [HyperText Transfer Protocol \(HTTP\)](#), which uses MIME headers for indicating the characteristics of data being transferred. Some elements of MIME were in fact developed not for e-mail but for use by HTTP or other protocols, and I indicate this where appropriate. Be aware, however, that HTTP only uses **elements** of MIME; there are important differences, and HTTP messages are not MIME-compliant.

MIME Message Format Overview, Motivation, History and Standards

I describe [the reasons why universal standards are important](#) in the [Networking Fundamentals chapter](#) of this Guide, and re-emphasize the point in many other places as well. Most protocols become successful for the specific reason that they are based on open

standards that are widely accepted. The [RFC 822 e-mail message format standard](#) is an excellent example; it is used by millions of people every day to send and receive TCP/IP e-mail.

However, success of standards comes at a price: *reliance* on those standards. Once a standard is in wide use, it is very difficult to modify it, even when times change and those standards are no longer sufficient for the requirements of modern computing. Again here, unfortunately, the RFC 822 e-mail message format is an excellent example.

The Motivation for MIME

TCP/IP e-mail was developed in the 1960s and 1970s. Compared to the way the world of computers and networking is today, almost everything back then was *small*. The networks were small; the number of users was small; the computing capabilities of networked hosts was small; the capacity of network connections was small; the number of network applications was small. (The only thing that wasn't small back then was the size of the computers themselves!)

As a result of this, the requirements for electronic mail messaging were also rather... small. Most computer input and output back then was text-based, and it was therefore natural that the creators of [SMTP](#) and the RFC 822 standard would have envisioned e-mail as being strictly a text medium. Accordingly, they specified RFC 822 to carry text messages.

The fledgling Internet was also developed within the United States, and at first, the entire internetwork was within American borders. Most people in the United States speak English, a language that as you may know uses a relatively small number of characters that is well-represented using the ASCII character set. Defining the e-mail message format to support United States ASCII (US-ASCII) also made sense at the time.

However, as computers developed, they moved away from a strict text model towards graphical operating systems. And predictably, users became interested in sending more than just text. They wanted to be able to transmit diagrams, non-ASCII text documents (such as Microsoft Word files), binary program files, and eventually multimedia information: digital photographs, MP3 audio clips, slide presentations, movie files and much more. Also, as the Internet grew and became global, other countries came "online", some of which used languages that simply could not be expressed with the US-ASCII character set.

Unfortunately, by this point, the die was cast. RFC 822 was in wide use and changing it would have also meant changes to how protocols such as SMTP, [POP](#) and [IMAP](#) worked, protocols that ran on millions of machines. Yet by the late 1980s, it was quite clear that the limitations of plain ASCII e-mail were a big problem that had to be resolved. A solution was needed, and it came in the form of the *Multipurpose Internet Mail Extensions (MIME)*.



Note: MIME is usually referred to in the singular, as I will do from here forward, even though it is an abbreviation of a plural term.

MIME Capabilities

The idea behind MIME is both clever and elegant—which means I like it! RFC 822 restricts e-mail messages to be ASCII text, but that doesn't mean that we cannot define a more specific structure for how that ASCII text is created. Instead of just letting the user type an ASCII text message, we can use ASCII text characters to actually encode non-text information (commonly called *attachments*). Using this technique, MIME allows regular RFC 822 e-mail messages to carry the following:

- Non-text information, including graphic files, multimedia clips and all the other non-text data examples I listed earlier;
- Arbitrary binary files, including executable programs and files stored in proprietary formats (for example, AutoCAD files, Adobe Acrobat PDF files and so forth);
- Text messages that use character sets other than ASCII. This even includes the ability to [use non-ASCII characters in the headers](#) of RFC 822 e-mail messages.

MIME even goes one step beyond this, by actually defining a structure that allows [multiple files to be encoded into a single e-mail message](#), including files of different types. For example, someone working on a budget analysis could send one e-mail message that includes a text message, a Powerpoint presentation, and a spreadsheet containing the budget figures. This capability has greatly expanded e-mail's usefulness in TCP/IP.

All of this is accomplished through special encoding rules that transform non-ASCII files and information into an ASCII form. Headers are added to the message to indicate how the information is encoded. The encoded message can then be sent through the system like any other message. SMTP and the other protocols that handle mail pay no attention to the message body, so they don't even know MIME has been used.

The only changes required to the e-mail software is adding support for MIME to e-mail client programs: both the sender and receiver must support MIME to encode and decode the messages. Support for MIME was not widespread when MIME was first developed, but the value of the technique is so significant that it is present in nearly all e-mail client software today. Furthermore, most clients today can also use the information in MIME headers to not only decode non-text information but pass it to the appropriate application for presentation to the user.



Key Concept: The use of the RFC 822 message format ensures that all devices are able to read each other's e-mail messages, but it has a critical limitation: it only supports plain, ASCII text. This is insufficient for the needs of modern internetworks, yet reliance on the RFC 822 standard would have made replacing it difficult. Instead, a new standard called the *Multipurpose Internet Mail Extensions (MIME)* was defined. MIME specifies several methods that allow e-mail messages to contain multimedia content, binary files, and text files using non-ASCII character sets, all while still adhering to the RFC 822 message format. MIME also further expands e-mail's flexibility by allowing multiple files or pieces of content to be sent in a single message.

MIME Standards

MIME was first described in a set of two standards, RFC 1341 and RFC 1342, published in June 1992. These were updated by RFCs 1521 and 1522 in September 1993. In March 1994, a supplemental standard was published, RFC 1590, which specified the procedure for defining new MIME media types.

Work continued on MIME through the mid-1990s, and in November 1996 the standards were revised again. This time, the documents were completely restructured and published as a set of 5 individual standards. This was done to improve the readability of the information. These standards are shown in [Table 242](#).

Table 242: Multipurpose Internet Mail Extensions (MIME) Standards

RFC Number	Name	Description
2045	<i><u>Multipurpose Internet Mail Extensions (MIME) Part One: Format of Internet Message Bodies</u></i>	Describes the fundamental concepts behind MIME and the structure of MIME messages.
2046	<i><u>Multipurpose Internet Mail Extensions (MIME) Part Two: Media Types</u></i>	Explains the concept of MIME media types and subtypes and describes some of the kinds of media whose encoding is defined in the MIME standards.
2047	<i><u>MIME (Multipurpose Internet Mail Extensions) Part Three: Message Header Extensions for Non-ASCII Text</u></i>	Describes how RFC 822 headers can be modified to carry non-ASCII text.
2048	<i><u>Multipurpose Internet Mail Extensions (MIME) Part Four: Registration Procedures</u></i>	Discusses how organizations can register additional media types for use with MIME.
2049	<i><u>Multipurpose Internet Mail Extensions (MIME) Part Five: Conformance Criteria and Examples</u></i>	Provides additional implementation information and examples of how MIME can be used.

Since the time that these five “primary” MIME standards came out, numerous additional RFCs have been published. These have defined various extensions to MIME itself, including additional MIME header types and new media types. Notable examples are RFCs 2183 and 2557, which define the MIME *Content-Disposition* and *Content-Location* headers, respectively. Some other MIME capabilities are actually defined as part of other technologies that use MIME; for example, the first [HTTP](#) standard, RFC 1945 defines the *Content-Length* header. Numerous other RFCs define new media types/subtypes, too many to list here.

MIME Basic Structures and Headers

The creators of the Multipurpose Internet Mail Extensions (MIME) standard had a difficult challenge on their hands: how to bring flexibility in the types of data contained in e-mail messages, when RFC 822 said that they had to be comprised of only ASCII text. To accomplish this, they had to exploit the areas of flexibility that had already been put into the existing RFC 822.

There were two such “opportunities” available. The first was the fact that RFC 822 message bodies are allowed to contain any type of ASCII text, as long as lines don't exceed 998 text characters and each line ends with a “CRLF” control code combination. Even though the creators of RFC 822 naturally assumed this ASCII text would be human-readable, there was nothing stopping it from being machine-readable code. The second was the facility built into RFC 822 (and the protocols that use it, such as SMTP) to allow custom “user-defined” header fields to be added to any e-mail message.

The non-specific nature of RFC 822 message bodies forms the basis for how MIME itself works. An e-mail client that supports the MIME standard uses special encoding algorithms that transform non-ASCII information into ASCII form. It then places this set of encoded ASCII characters into the body of the message, as if it had been typed by a user, using one of two special structures.

The ability to add new headers to RFC 822 is used to communicate information about the use of MIME from the sender to the recipient. The devices transporting a MIME message don't care that MIME was used, because they don't pay attention to the contents of the message body. However, when the message reaches its destination, the recipient's e-mail client program must have some way of knowing that MIME was used, and must also be told how the information in the message was encoded. Otherwise, it might just present the encoded non-ASCII data to the user as ASCII text (which would look like random gibberish!)

Basic Structure Types

The exact method by which data is encoded in the message body and MIME headers are included depends on the overall structure of the MIME message. There are two basic structure types, which are described based on the kind of media the message carries:

- ① **Simple Structure (Discrete Media):** MIME messages carrying a single *discrete* media type, such as a text message or a graphical image, use a simple structure. Only one encoding of information is present in the body of the message.
- ② **Complex (Composite Media) Structure:** Some MIME messages carry a *composite* media type, which allows multiple different media to be contained in a single message, such as a text message **and** a graphical image, or to encapsulate another e-mail message in its entirety. Many of these use a more complex structure where the body of the message contains several *MIME body parts*.

MIME Entities

Collectively, both whole MIME messages and individual body parts are called *MIME entities*. Each set of MIME headers provides information about either type of MIME entity: a MIME message as a whole, or a body part in a composite message. When a MIME message is received, the recipient first examines the headers in the message as a whole (the RFC 822 headers) to determine the overall message type. This then indicates if the message uses a simple or complex structure. If the latter, the body of the message is

parsed and each individual body part is individually interpreted, including its individualized headers. [The topic on composite media types](#) has more details on how these body parts are formatted.

Primary MIME Headers

The first of the five main MIME standards, RFC 2045, describes a set of five primary MIME headers that communicate basic information about the content of each MIME entity (message or body part).

MIME-Version

Each MIME message is required to have a *MIME-Version* header, which serves two purposes. First, it identifies the e-mail message as being MIME-encoded. Second, even though only one version of MIME has been defined so far, having a version number header provides “future-proofing” in case a new version is created later that may have some incompatibilities with the present one. Right now, all MIME messages use version 1.0.

This is the only MIME header that applies only to an entire message; it is not used to label individual MIME body parts. This is easy to remember as it is the only header whose name does not begin with “Content-”.

Content-Type

Describes the nature of the data that is encoded in the MIME entity. This header specifies a content *type* and a content *subtype*, which are separated by a slash character. It may optionally also contain certain *parameters*, that convey additional information about the type and subtype. In a message body, this header is what tells the recipient of the e-mail message what sort of media it contains, and whether the body uses a simple or complex structure. In a body part, it describes the media type the body part contains.

For example, a message containing an HTML document might have a *Content-Type* header of “text/html”, where a message containing a JPEG graphical file might be specified as “image/jpeg”. For a composite MIME type, the *Content-Type* header of the whole message will contain something like “multipart/mixed” or “multipart/alternative”, and each body part will contain individual *Content-Type* headers such as “text/html” or “image/jpeg”. These are all discussed in detail in the next two topics.

This header is optional. When not present, the default of a regular US-ASCII text message is assumed (the media type of regular RFC 822 messages).

Content-Transfer-Encoding

For a message using simple structure, specifies the specific method that was used to encode the data in the message body; for a composite message, identifies the encoding method for each MIME body part. For data that is already in ASCII form, no special

encoding is needed, but other types of data must be converted to ASCII for transmission. This header tells the recipient how to decode the data back into its normal representation. [MIME encoding methods are described later in this section.](#)

This header is optional; the default value if it is not present is “7bit” encoding, which again is the encoding of regular ASCII.

Content-ID

Allows the MIME content to be assigned a specific identification code. This header is analogous to the RFC 822 *Message-ID* header field, but is specific to the MIME content itself. It is optional, and is most often used for body parts in multipart MIME messages.

Content-Description

This is an optional header that allows an arbitrary additional text description to be associated with the MIME entity. In a multipart message, each body part might be given a description header to make clear to the recipient what the parts represent.

Additional MIME Headers

In addition to the five basic headers above, the MIME standard allows additional ones to be defined. The only restriction is that they all must start with the word “Content-”, which again, clearly labels them as describing content of a MIME entity (message or body part). Obviously, both sender and recipient must support a custom header for it to be useful.

Several new MIME headers have in fact been created and documented in various Internet RFCs. Some are actually designed not specifically for use by e-mail messages, but for use by other protocols that make use of MIME technology, such as the [HyperText Transfer Protocol \(HTTP\)](#). Here are three notable ones.

Content-Disposition

In multipart MIME messages, this header may be given to MIME body parts to control how information is presented to the user. The two most common values are “inline”, which says the content is intended to be displayed automatically along with other body parts, and “attachment”, which indicates that the content is separate from the main document. This header is defined in RFC 2183.

Content-Location

Allows the location of a MIME body part to be identified using a [uniform resource identifier \(URI\)](#). This is sometimes used when encoding HTML and other multimedia-enabled document formats into e-mail using MIME multipart messages. It is defined in RFC 2557.

Content-Length

Specifies the length of a MIME entity in bytes. This header is not commonly used in e-mail applications of MIME, but [is an important header in HTTP](#). It is described in the HTTP standards, first appearing in RFC 1945.



Key Concept: MIME provides flexibility in the information that can be carried in e-mail messages, by encoding non-ASCII data in ASCII form, and by adding special headers that describe this data and how it is to be interpreted. The most important MIME headers are *Content-Type*, which describes what sort of data is in the message, and *Content-Transfer-Encoding*, which specifies how the data is encoded. MIME supports two basic overall formats: *simple structure*, in which a single type of *discrete media* is encoded in a message; and *complex structure*, which encodes a *composite media* type that can carry multiple kinds of information.

MIME Content-Type Header and Discrete Media: Types, Subtypes and Parameters

MIME transforms TCP/IP e-mail from the drab, text-only world of [RFC 822](#), to a rich communication method that can carry many types of data. It accomplishes this by using special techniques to encode various kinds of information into ASCII text form, such as graphical images, sound files, video clips, application programs, compressed data files, and many others. We commonly refer to these as different types of *media*, and MIME uses the same term to describe them.

Since MIME supports so many kinds of media, it is necessary that each message contain information that describes what it contains, to permit accurate decoding of message contents. This is the function of the important MIME *Content-Type* header.

Content-Type Header Syntax

The syntax of the header is as follows:

Content-Type: <type>/<subtype> [; parameter1 ; parameter2 .. ; parameterN]

The purpose of these different elements is to describe the media in the MIME entity in a way that proceeds from the general to the specific. The first element, “<type>”, is called the *top-level media type* and describes the overall form of the data. For example, it indicates if the MIME entity contains text, an image, audio and so forth. The second element, “<subtype>”, provides specific information about the form or format of the data. For example, a JPEG image and a GIF image are both images, but they are in a different format. Both “<type>” and “<subtype>” are mandatory in the *Content-Type* header.

Following these elements may appear one or more *parameters*, which are usually optional but may be required for some media types. These provide still more detailed specification of the nature of the data, when it is required. Each parameter is preceded by a semi-colon and is expressed as an attribute/value pair, separated by an “=” sign, like this:

; attribute=value

One example of how parameters may be used is in specifying the character set in a text message. The representation of “regular” RFC 822 ASCII text is as follows:

Content-type: text/plain; charset=“us-ascii”

The top-level media type is “text”, and the subtype is “plain”, so this indicates a plain text message. The parameter “charset” specifies that the message uses the US ASCII character set. Another common use for parameters is to specify the name of an attached file, like this:

Content-type: image/jpeg; name=“ryanpicture.jpg”

Discrete Media Types and Subtypes

As I mentioned in [the preceding topic](#), MIME supports two basic structures: simple or complex. A simple message carries only one media type, such as a piece of text, a picture or an executable file. These are called *discrete media types* in MIME. A complex message carries a *composite media type*, which may incorporate multiple body parts. Each body part in turn carries data corresponding to one of the discrete media types. The top-level media type indicates whether the whole message carries a discrete media type or a composite type; I will describe the discrete media types here; the composite types are discussed in [the next topic](#).

The RFC 2046 standard (part two of the [set of five standards that describes MIME](#)) defines five discrete top-level media types: *text*, *image*, *audio*, *video* and *application*; they each represent one of the major classes of data commonly transmitted over TCP/IP. Each of these has one or more subtypes, and some also have parameters that are used to provide more information about them.

The creators of MIME recognized that the standard could not describe every media type, and that new ones would be created in the future. RFC 2048 (part four of the five-standard MIME set) describes the process by which new media types, subtypes and parameters can be described and registered with the [Internet Assigned Numbers Authority \(IANA\)](#).

Thus far, only one new top-level media type has been created; this is the *model* top-level type, defined for CAD modeling files and similar uses, as described in RFC 2077. However, many dozens of new *subtypes* have been created over the years, some specified in RFCs and others just registered directly with IANA. This includes many “vendor-specific” subtypes, which are usually identified by either the prefix “x-” or “vnd.” in the subtype name.



On The Web: You can find a complete list of MIME media organized by top-level media type, on IANA's web site: <http://www.iana.org/assignments/media-types/index.html>



Key Concept: The MIME *Content-Type* header specifies what sort of data is encoded in a MIME message. The header indicates the general form of the message's content through a *top-level media type*, and the more specific nature of the data through the specification of a *subtype*. It may also contain optional *parameters* that provide still more information about the content.

Common Discrete Media Types and Subtypes

There are literally hundreds of type/subtype combinations now, and I will not try to list them all, but will briefly describes the six MIME discrete top-level media types. For each, a table has been provided showing some of the more commonly-encountered MIME subtypes, to give you an idea of what is "out there". This includes a description of each subtype and a reference to the place where it is defined.

Text Media Type (*text*)

This type is used for sending data that is primarily in textual form ([Table 243](#)).

Table 243: MIME *text* Media Type Subtypes

type/subtype	Description	Defining Source
<i>text/plain</i>	Plain text, used for regular messages such as those corresponding to the initial RFC 822 standard.	RFC 2046
<i>text/enriched</i>	Text that includes formatting information or other "enrichment" that makes it no longer "plain".	RFC 1896
<i>text/html</i>	A document expressed in Hypertext Markup Language (HTML) , commonly used for the World Wide Web .	RFC 2854
<i>text/css</i>	Cascading style sheet information for the World Wide Web.	RFC 2318

Image Media Type (*image*)

The *image* type indicates graphical image files, such as pictures. The subtype normally indicates the specific format to allow the recipient to properly decode and present the file, with some of the more common subtypes given in [Table 244](#).

Table 244: MIME *image* Media Type Subtypes

type/subtype	Description	Defining Source
<i>image/jpeg</i>	An image in JPEG format.	RFC 2046
<i>image/gif</i>	A Graphical Interchange Format (GIF).image.	(IANA says RFC 2046 but it's not there...)
<i>image/tiff</i>	Tagged Image File Format (TIFF) image.	RFC 2302
<i>image/vnd.dwg</i> , <i>image/vnd.dxf</i> , <i>image/vnd.svf</i>	Vector images used in AutoCAD.	Registration with IANA

Audio Media Type (*audio*)

This media type is used for sending audio information. The subtype normally indicates the specific format, with [Table 245](#) showing a couple of common values.

Table 245: MIME *audio* Media Type Subtypes

type/subtype	Description	Defining Source
<i>audio/basic</i>	A "basic" audio type defined in the main MIME standards. It describes single-channel audio encoded using 8-bit ISDN mu-law PCM at 8000 Hz.	RFC 2046
<i>audio/mpeg</i>	MPEG standard audio (including the popular MP3 file format).	RFC 3003

Video Media Type (*video*)

This type is used for sending video information. Again, the subtype normally indicates the specific format ([Table 246](#)).

Table 246: MIME *video* Media Type Subtypes (Page 1 of 2)

type/subtype	Description	Defining Source
<i>video/mpeg</i>	Video encoded to the MPEG digital video standard.	RFC 2046

Table 246: MIME *video* Media Type Subtypes (Page 2 of 2)

type/subtype	Description	Defining Source
<i>video/dv</i>	Digital video corresponding to several popular standards including SD-VCR, HD-VCR, and DVB, as used by various types of video equipment.	RFC 3189
<i>video/quicktime</i>	Apple's Quicktime movie format.	Registration with IANA

Model Media Type (*model*)

This type describes a model representation, such as a two-dimensional or three-dimension physical model ([Table 247](#)).

Table 247: MIME *model* Media Type Subtypes

type/subtype	Description	Defining Source
<i>model/mesh</i>	A mesh, as used in modeling.	RFC 2077
<i>model/vrml</i>	A Virtual Reality Modeling Language (VRML) model.	RFC 2077
<i>model/iges</i>	A model file corresponding to the Initial Graphics Exchange Specification (IGES).	Registration with IANA

Application Media Type (*application*)

This media type is a “catch all” for any kind of data that doesn't fit into one of the categories above, or that is inherently application-specific. The subtype describes the data by indicating the kind of application that uses it. This can be used to guide the recipient's e-mail program in choosing an appropriate application program to display it, just like how a file extension in Windows tells the operating system how to open different kinds of files.

For example, if you have Microsoft Excel installed on your PC, clicking a file ending with “.XLS” will launch Excel automatically. Similarly, an Excel spreadsheet will normally be sent using MIME with a media type of *application/vnd.ms-excel*. This tells the recipient's e-mail program to launch Excel to read this file.

Since there are so many applications out there, there are over a hundred different subtypes within this top-level type. [Table 248](#) contains a few representative samples.

Table 248: MIME *application* Media Type Subtypes

type/subtype	Description	Defining Source
<i>application/octet-stream</i>	An arbitrary set of binary data octets. See below for more details.	RFC 2046
<i>application/postscript</i>	A Postscript file, used for printing and for generating Adobe Acrobat (PDF) files.	RFC 2046
<i>application/applefile</i>	Resource file information for representing Apple Macintosh files.	Registration with IANA
<i>application/msword</i>	Microsoft Word document. Note that this does not have the “vnd” prefix like most other Microsoft file types.	Registration with IANA
<i>application/pdf</i>	A Portable Document Format (PDF) file, as created by Adobe Acrobat.	Registration with IANA
<i>application/vnd.framemaker</i>	An Adobe FrameMaker file.	Registration with IANA
<i>application/vnd.lotus-1-2-3</i>	A Lotus 1-2-3 file.	Registration with IANA
<i>application/vnd.lotus-notes</i>	A Lotus Notes file.	Registration with IANA
<i>application/vnd.ms-excel</i>	A Microsoft Excel spreadsheet file.	Registration with IANA
<i>application/vnd.ms-powerpoint</i>	A Microsoft Powerpoint presentation file.	Registration with IANA
<i>application/vnd.ms-project</i>	A Microsoft Project file.	Registration with IANA
<i>application/zip</i>	A compressed archive file containing one or more other files, using the ZIP/PKZIP compression format.	Registration with IANA

Of these, there is one special subtype that is worth further mention: the *application/octet-stream* subtype. This is a “catch all” within the “catch all” of the *application* type, and just means the file is a sequence of arbitrary binary data. It is usually used when the sender is unsure of what form the data takes, or cannot identify it as belonging to a particular application. When this type is used, the recipient will usually be prompted to just save the data to a file. He or she must then figure out what application to use to read it.

The *application/octet-stream* MIME type/subtype may even be used for images, audio or video in unknown formats. If you try to send a multimedia document that your sending program does not understand, it will generally encode it as *application/octet-stream* for transmission. This is your e-mail program's way of saying to the recipient “I am sending you this file as-is, you figure out what to do with it”.

This *application/octet-stream* type is also very often used for transmitting executable files (programs) especially on Windows systems. Unfortunately, while convenient, this can be a serious security hazard. In recent years, the Internet has been subject to a steady stream of viruses and worms that spread by sending themselves to other users through executable file attachments in e-mail. This makes opening and running any unknown *application/octet-stream* attachment potentially dangerous.

MIME Composite Media Types: Multipart and Encapsulated Message Structures

MIME **discrete media types** allow MIME to represent hundreds of different kinds of data in e-mail messages. This alone would make MIME an incredibly useful technology, but the MIME standard goes one step further, by defining *composite* media types. These allow MIME to perform even more “spectacular feats”, such as sending many types of data at once, or encapsulating other messages or information into e-mail.

The use of a MIME composite media type is indicated via the *Content-Type* header of an RFC 822 message. Instead of one of the six discrete media types (*text*, *image*, *audio*, *video*, *model* and *application*), one of these two composite media types is used:

- ☉ **Multipart Media Type (*multipart*):** Allows one or more sets of data to be sent in a single MIME message. Each piece of data is represented as an individual discrete media type.
- ☉ **Message Media Type (*message*):** Allows a message to encapsulate another message. This may be another e-mail message previously sent, or a message of some other kind. This media type also provides flexibility for sending partial messages and other special types of communication.



Key Concept: There are two MIME composite media types: *message*, which allows one message to encapsulate another, and *multipart*, which allows multiple individual media types to be encoded into a single e-mail message.

MIME Multipart Message Type

The *multipart* media type is the more common of the two, and for good reason: it is an ***incredibly*** powerful mechanism. It allows one message to contain many different kinds of information that can be used in different ways. Each piece of data is encoded separately as a MIME *body part* and the parts are combined into a single e-mail message. How these parts are used depends on the semantics of the message, which is indicated by the MIME subtype. RFC 2046 describes several of these, and a few new ones have also been defined by the IANA registration scheme described in the previous topic.

MIME Multipart Message Subtypes

The following are the most common multipart media subtypes, and how they are used. The first four are defined in RFC 2046, and the others as indicated:

-
- ④ ***multipart/mixed***: Indicates that the body parts are not really related, but have just been bundled for transport in a single message for convenience. For example, this might be used by someone to send an office memo along with a vacation snapshot just for fun. This subtype is also used sometimes when the parts are related but the relationship is communicated to the recipient in some other way (such as a description in a distinct body part).
 - ④ ***multipart/alternative***: Specifies that the body parts are alternative representations of the same information. The recipient decodes the parts and chooses the one that is best suited to his or her needs. A common use of this is in sending [HTML](#)-encoded e-mail. Some e-mail clients can't display HTML, so it is courteous to send a *multipart/alternative* message containing the message in both HTML and plain text forms.

The alternatives should be placed in the message in increasing order of preference, meaning that the preferred format goes last. In the case of a document that includes plain text and rich text alternatives—such as the example above with plain text and HTML versions of a document—the plainest format should go first and the “fanciest” last.

- ④ ***multipart/parallel***: Tells the recipient that the body parts should all be displayed at the same time (“in parallel”). One example of how this might be used would be if someone sent an audio clip along with explanatory text to be displayed alongside it as it played.
- ④ ***multipart/digest***: This is used to allow a message to carry a digest, such as a collection of other e-mail messages.
- ④ ***multipart/related***: Indicates specifically that the body parts are related to each other. Special parameters are used to provide more information on how they are to be interpreted. This subtype was defined in RFC 2387.
- ④ ***multipart/encrypted***: Used for encrypted data. The first body part contains information on how the data is to be decrypted, and the second contains the data itself. This subtype was defined in RFC 1847.

Multipart Message Encoding

You can see just from these different subtypes how much flexibility the *multipart* type provides to MIME, and there are others. In all cases, the same syntax is used to encode the constituent body parts into a single message. The basic process is as follows:

1. Each individual piece of data is processed as if it were to be transmitted as the body of a discrete media type MIME message. This includes the specification of appropriate headers, such as *Content-Type*, *Content-ID* and *Content-Transfer-Encoding*, as needed.
2. A special *boundary delimiter* is chosen to separate the body parts. It must be selected so that it will not appear in any of the body parts; a random string is sometimes used. It is prepended with two dashes (“--”) when placed in the message to reduce the chance of it being mistaken for data.
3. The multipart message is assembled. It consists of a *preamble* text area, then a boundary line, followed by the first body part. Each subsequent body part is separated from the previous one with another boundary line. After the last body part, another boundary line appears, followed by an *epilogue* text area.

-
4. The special parameter *boundary* is included in the *Content-Type* header of the message as a whole, to tell the recipient what pattern separates the body parts.



Key Concept: MIME multipart messages are formed by first processing each individual data component to create a MIME *body part*. Each can have a distinct encoding method and set of headers, as if it were a separate MIME message. These body parts are then combined into a single multipart message, and separated with a *boundary delimiter*. The identity of the delimiter is inserted into the *boundary* parameter of the *Content-Type* header, so the recipient can easily separate the individual body parts upon receipt of the message.

Multipart Message Structure

These rules seem rather complicated, but they really aren't that bad; once you've seen a couple of multipart messages the structure will make sense. To help clarify, I have provided [Figure 302](#), which shows graphically the overall structure of a multipart MIME message.

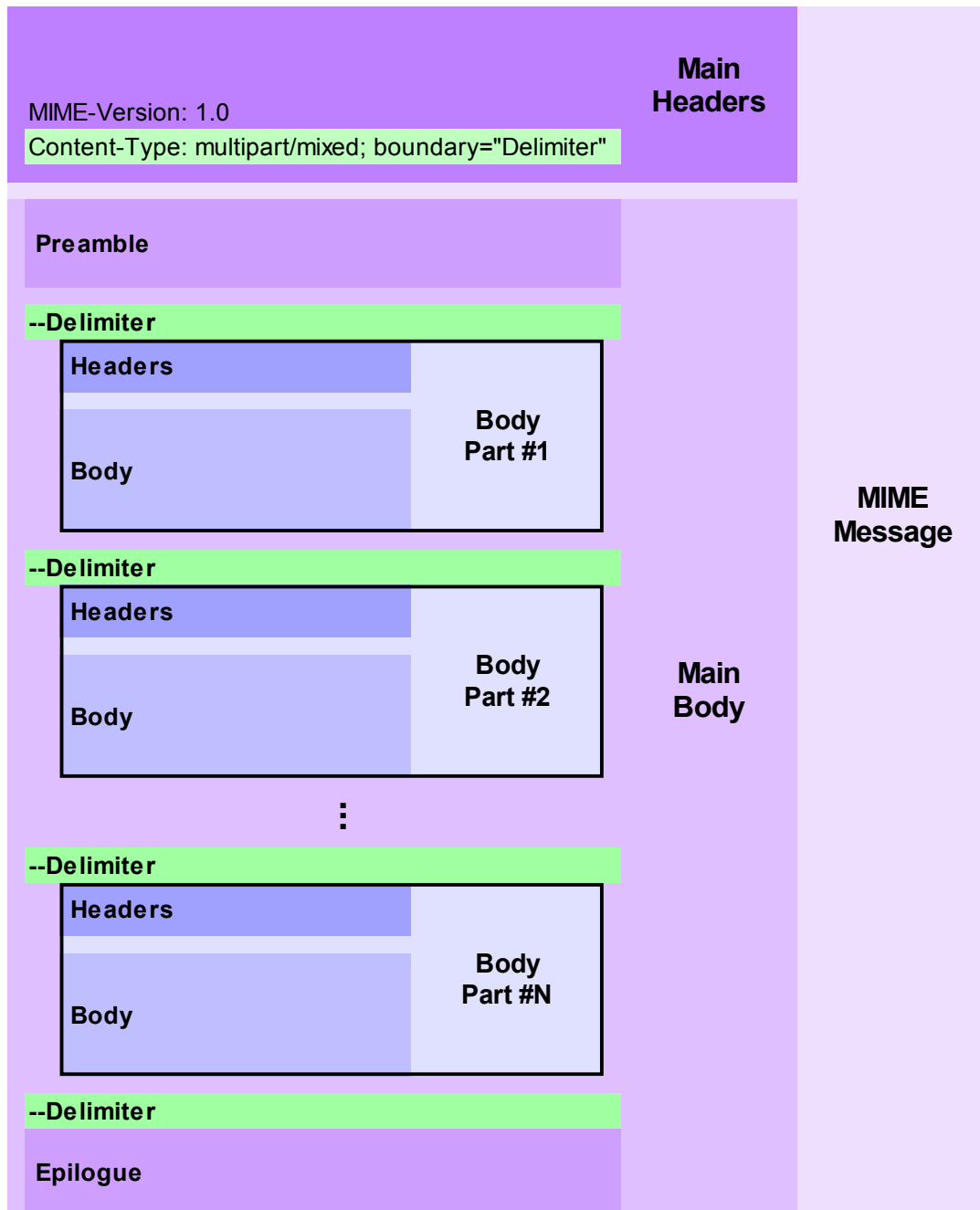

Figure 302: MIME Multipart Message Structure

A MIME multipart message consists of a set of main headers and a main body portion, like all messages. Within the main body are one or more body parts, each of which has its own body-part-specific headers followed by the body part itself; each body part is shown in blue. The *Content-Type* header of the message as a whole (highlighted in green) indicates that the message type is multipart, and the *boundary* parameter specifies the name of the delimiter, in this case just called "Delimiter" (how boring.) This delimiter is used to separate the body parts from each other and from the preamble and epilogue that begin and end the message body, respectively.

Example Multipart Message

Table 249 contains a specific example of a multipart message (with portions abbreviated to keep length down), so you can see what one looks like in text form. (If you want to see more, you probably have several in your own e-mail inbox right now!)

Table 249: Example MIME Multipart Message

```
From: Joe Sender <joe@someplace.org>
To: Jane Receiver <jane@somewhereelse.com>
Date: Sun, 1 Jun 2003 13:28:19 -0800
Subject: Photo and discussion
MIME-Version: 1.0
Content-Type: multipart/mixed; boundary="exampledelimtext123"

This is a multipart message in MIME format

--exampledelimtext123
Content-Type: text/plain

Jane, here is the photo you wanted me for the new client.
Here are some notes on how it was processed.
(Blah blah blah...)
Talk to you soon,
Joe.

--exampledelimtext123

Content-Type: image/jpeg; name="clientphoto.jpg"
Content-Transfer-Encoding: base64

SDc9Pjv/2wBDAQoLCw4NDhwQEBw7KCIoOzs7Ozs7Ozs
...
zv/wAARCADIARoDASIAAhEBAxEB/8QAHAAAAQUBA

--exampledelimtext123

(Epilogue)
```

In this example, Joe is sending Jane a multipart message containing a JPEG photograph and some explanatory text. The main header of the message specifies the *multipart/mixed* type and a boundary string of “exampledelimtext123”. The message begins with the *preamble*, which is ignored by the recipient e-mail client but can be seen by the human reader. It is common to put a string here such as the one given in this example. That way, if a person using a client that does not support MIME receives the message, the recipient will know what it is.

The first delimiter string is then placed in the message, followed by the first body part, the text Joe is sending Jane. This is preceded by whatever headers are needed by the body part, in this case *Content-Type: text/plain*. (Note, however, that this is the default in MIME, so it could be omitted here.) After the text message is another delimiter and then the encoded JPEG photo in the second body part, with its own headers. Finally, one more delimiter and then a space for the *epilogue*. This is ignored if present, and is often not used at all.

It is possible to send a “multipart” message that has only a single body part. This is sometimes done to take advantage of the preamble area to provide information about how to decode a non-text media type. Of course, this can also be done by including such text decoding instructions as a body part.

MIME Encapsulated Message Type

The other composite media type is the *message* type, which is devoted to the special purpose of encapsulating existing e-mail messages within the body of a new message, or for encapsulating other types of messages. The following are the subtypes defined in RFC 2046:

- ☉ ***message/rfc822***: Indicates that the body contains an encapsulated e-mail itself formatted according to the RFC 822 standard. Note that this doesn't necessarily mean it is a plain text e-mail message; it could be a MIME message (though encapsulating MIME within MIME must be done carefully...)
- ☉ ***message/partial***: Used to allow the fragmentation of larger messages into pieces that can later be reassembled. This is described in detail in RFC 2046.
- ☉ ***message/external-body***: Indicates that the body of the message is not actually contained in the message itself; instead, a reference is provided to where the actual body is located. Sufficient information to locate the real message body must be provided. Again, this “out of body experience” is described in RFC 2046. (Sorry, couldn't resist! ☺)

MIME Content-Transfer-Encoding Header and Encoding Methods

One of the main reasons why MIME was created was the [significant restrictions](#) that the RFC 822 standard places on how data in e-mail messages must be formatted. To follow the rules, messages must be encoded in US ASCII, a 7-bit data representation. This means that even though each byte can theoretically have any of 256 values, in ASCII only 128 values are valid. Furthermore, lines can be no longer than 1000 characters including the carriage return and line feed (“CRLF”) characters at the end, and those two characters cannot appear elsewhere.

For some types of data, such as text files, this is no big deal, but for others it is a serious problem. This is especially the case with binary data. If you look at the data in a video clip or MP3 file or executable program, it will appear to be “random gibberish”. In fact, such data is not random but is represented using specific rules, but the data is expressed in raw binary

form, where any 8-bit byte can contain any value from 0 to 255, which is why it looks like “junk” to humans. More importantly, this means that this data does not follow the rules for RFC 822 files and cannot be sent directly in this form.

MIME Encoding Methods

To send non-ASCII data in MIME, it is necessary that it be encoded. The *Content-Transfer-Encoding* header is used to specify how a MIME message or body part has been encoded, so that it can be decoded by its recipient. The following types of encoding are defined:

- ☉ **7bit:** This indicates that the message is already in ASCII form compatible with RFC 822. It is the default and is what is assumed if no *Content-Transfer-Encoding* header is present.
- ☉ **8bit / binary:** These synonymous values mean the message has been encoded directly in 8-bit binary form. Yes, I did just say that this would violate the rules of RFC 822. These options appear to have been included to support future mechanisms for transporting binary data directly. RFC 1652 describes an SMTP extension that discusses this in part: *SMTP Service Extension for 8bit-MIMEtransport* (sic, there is no space between “MIME” and “transport”). However, the standard is clear that this still does not allow the transfer of raw binary data using SMTP and RFC 822.
- ☉ **quoted-printable:** This is a special encoding that is used when most of the data is ASCII text, but when it contains certain violations of the rules of RFC 822. These illegal sections are converted using special encoding rules so the data as a whole is consistent with RFC 822.
- ☉ **base64:** An encoding used to allow arbitrary binary data to be represented in ASCII form. The data is then sent as ASCII and decoded back into binary form by the recipient.

The *quoted-printable* and *base64* encodings are the most interesting ones, because they are what allow non-RFC-822 data to be sent using RFC 822.



Key Concept: MIME supports four encoding methods: *7bit*, *8bit (binary)*, *quoted-printable* and *base64*. *7bit* encoding is standard ASCII and is used for text; *quoted-printable* encoding is for output that is mostly text but has some special characters that must be encoded; *base64* is used for arbitrary binary files. (The *8bit* encoding method is defined in MIME but not used for RFC 822 messages.)

***quoted-printable* Encoding**

This encoding method is used when the message is “mostly” ASCII; only the problem bytes are encoded. The result is that RFC 822 compatibility is achieved while maintaining most of the data as regular text so it can still be easily understood by a human.

An example of where this would be letters with tildes or accents, such as those used in French or Spanish. Another would be a text message formed using an editor that inserts carriage return characters in the middle of a line. Most of the message is still text. The

quoted-printable encoding can be used here, with the carriage return characters represented as “=0D” (the hexadecimal value of the character prepended by an equal sign). RFC 2046 contains more details on how this is done.

base64 Encoding

In contrast, the *base64* encoding is more often used for raw binary data that is not in human-readable form anyway, such as graphical images, audio, video and application files. The idea behind it is simple: the data that needs to be sent can have any value for each 8-bit byte, which is not allowed. So, why not rearrange the bits so the data “fits” into the 7-bit ASCII limits of RFC 822?

This is done by processing the data to be sent three bytes at a time. There are 24 bits in each three-byte block, which are carved into 4 sets of 6 bits each. Each 6-bit group has a value from 0 to 63, and is represented by a single ASCII character as presented in [Table 250](#).

Table 250: MIME Base64 Encoding Groups

6-bit Value	Encoding	6-bit Value	Encoding	6-bit Value	Encoding	6-bit Value	Encoding
0	A	16	Q	32	g	48	w
1	B	17	R	33	h	49	x
2	C	18	S	34	i	50	y
3	D	19	T	35	j	51	z
4	E	20	U	36	k	52	0
5	F	21	V	37	l	53	1
6	G	22	W	38	m	54	2
7	H	23	X	39	n	55	3
8	I	24	Y	40	o	56	4
9	J	25	Z	41	p	57	5
10	K	26	a	42	q	58	6
11	L	27	b	43	r	59	7
12	M	28	c	44	s	60	8
13	N	29	d	45	t	61	9
14	O	30	e	46	u	62	+
15	P	31	f	47	v	63	/

For example, suppose the first three bytes of the data to be sent were the decimal values 212, 39 and 247. These cannot all be expressed in 7-bit ASCII. In binary form they are:

11010100 00100111 11110111

We can divide these into four 6-bit groups:

110101 - 00 0010 - 0111 11 - 110111

Which yields the four values 53, 2, 31 and 55. Thus, the values 214, 39 and 247 would be encoded as the three ASCII characters “1Cf3”. The conceptual steps of this process are shown in [Figure 303](#).

Data Bytes in Decimal Form	212		39		247	
Data Bytes In Binary Form	11010100		00100111		11110111	
Data Rearranged Into 6-Bit Groups	110101	000010	011111	110111		
6-Bit Groups In Decimal Form	53	2	31	55		
Groups Converted To ASCII Characters	1	C	f	3		

Figure 303: MIME Base64 Encoding

In this simplified example, three binary data bytes are encoded as four ASCII characters using MIME base64 encoding. Instead of transmitting those three bytes, two of which would not be valid in RFC 822, the four ASCII characters “1Cf3” are sent.



Note: The sequence of steps for the encoding that I mentioned above and showed in the figure are intended to help you understand the process. Computers inherently deal directly with bits, and so would not bother with converting to decimal before encoding the 6-bit groups into ASCII characters.

This 3-to-4 encoding is done for all the data. The converted ASCII characters are then placed into the body of the entity instead of the raw binary data, 76 characters to a line. I showed how this is done in the second body part in the example of [Table 249](#) (except I didn't put 76 characters per line, to keep the line lengths short). One final character is involved in this scheme, the equal sign (“=”), which is used as a padding character when needed.

Since base64 characters are regular ASCII, they appear to SMTP like a “regular text message”. Of course the data looks like gibberish to us, but that's not a problem since it will be converted back to its regular form and displayed to the recipient as an image, movie, audio or whatever.



Key Concept: MIME uses *base64* encoding to transform arbitrary 8-bit files into a form that is acceptable for communication in e-mail. Each set of three 8-bit bytes is divided into four 6-bit groups, and each 6-bit group represented by an ASCII character. Since the data is ASCII, it conforms to the RFC 822 message format standard, even if it is not human-readable. The receiving device reverses the encoding, changing each four-character block back into three 8-bit bytes.

The main drawback of the base64 method? It is about 33% less efficient than sending binary data directly, using something like FTP. The reason is that three 8-bit bytes of binary data are sent as four ASCII characters, but of course, each ASCII character is represented using 8 bits itself. So there is 1/3 extra overhead when using base64. In most cases this is not a big deal, but it can be significant if downloading very large e-mail files over a slow Internet connection.

Note that RFC 2046 also defines two other encodings: *ietf-token* and *x-token*. These are included to allow new encoding types to be defined in the future.

MIME Extension for Non-ASCII Mail Message Headers

All of the MIME mechanisms discussed in this section up to this point deal with ways of encoding different kinds of ASCII and non-ASCII data into the **body** of an RFC 822 message. In addition to these capabilities, MIME also includes a way in which non-ASCII data can be encoded into **headers** of an RFC 822 message.

The Need for MIME-Encoded Headers

At this point you might be wondering why anyone would want to do this. Sure, it makes sense to be able to use MIME to encode binary data such as an image into an e-mail, but why do it in a header? Well, if you can't see the need for this, chances are that you are a native English speaker. ☺ ASCII does a great job of representing English, but isn't so hot with many other languages. With RFC 822, the speakers of languages that use non-ASCII characters were unable to fully use descriptive headers such as the *Subject* and *Comments* headers. Some could not even properly express their own names!

The solution to this problem is the subject of RFC 2047, the third of the five main MIME standards. It describes how to encode non-ASCII text into ASCII RFC 822 message headers. The idea is straight-forward: just as with message bodies, the non-ASCII text is replaced with ASCII, and information is provided to describe how this was done.

MIME Encoded-Word Syntax

In the MIME non-ASCII header technique, the value of a regular header is replaced by a MIME *encoded-word* that has the following syntax:

=?<charset>?<encoding>?<encoded-text>?='

The strings “=?” and “?=” are used to *bracket* the non-ASCII header, which flags it as a MIME encoded header to the recipient's e-mail client. The other elements, separated by “?”, indicate how the non-ASCII text is encoded:

- ☉ **<charset>**: The character set used, such as “iso-8859-1”.
- ☉ **<encoding>**: Two different encoding types are defined, each represented by a single letter for brevity:
 - ☉ **“B”**: This indicates *base64* encoding, as described in [the previous topic](#).
 - ☉ **“Q”**: This indicates *quoted-printable* encoding, again as in [the prior discussion](#).
- ☉ **<encoded-text>**: The non-ASCII text that has been encoded as ASCII using the encoding type indicated.

As you can see, this method is analogous to how a non-ASCII message body or body part would be encoded, but the information about the encoding has been condensed so everything can fit in a single header line. The “<charset>” parameter is somewhat analogous to the *Content-Type* header for a message body, but since headers can only contain text, it specifies what kind of text it is. The “<encoding>” parameter is clearly equivalent to the *Content-Transfer-Encoding* header.

Example Non-ASCII MIME Header

Here's an example of a non-ASCII header, using the GB2312 character set (for Chinese characters) and base64 encoding:

Subject: =?GB2312?B?u7bTrbLOvNPDwLn61bm74Q==?=

I hope that doesn't say anything inappropriate; I took it from a piece of spam e-mail I received once! ☺



Key Concept: In addition to its many functions for encoding a variety of data in e-mail message bodies, MIME provides a feature that allows non-ASCII information to be placed into e-mail headers. This is done by encoding the data using either *quoted-printable* or *base64* encoding, and then using a special format for the header value that specifies its encoding and character set. This technique is especially useful for e-mail sent in languages that cannot be represented easily in standard ASCII, such as many Asian languages.



TCP/IP Electronic Mail Delivery Protocol: The Simple Mail Transfer Protocol (SMTP)

I have emphasized in my [overall description of TCP/IP electronic mail](#) that communication using e-mail requires the interaction of various protocols and elements. One mistake that some people make is to equate the method used for delivering e-mail with the entire system. This is, however, an understandable mistake: just as the postal service is only a part of the whole system of mailing a letter; it is nonetheless a very **big** part. Likewise, the delivery of e-mail from sender to recipient is arguably the most important part of e-mail as a whole. In modern TCP/IP, this task is the responsibility of the *Simple Mail Transfer Protocol (SMTP)*.

In this section, I describe in detail the operation of the Simple Mail Transfer Protocol (SMTP). I begin with an overview and history of SMTP and a discussion of the standards that define it. I then examine the way that SMTP client/server communication and message transport works. I explain the way that SMTP servers establish connections and transaction sessions, and then the process by which mail is transferred from one to another. I describe some of the special features implemented in SMTP, and discuss SMTP security issues as well. I conclude with a reference summary of SMTP commands and replies.



Background Information: My discussion of SMTP assumes that you already have a basic understanding of the [general concepts of TCP/IP e-mail](#), as well as familiarity with TCP/IP [e-mail addressing](#) and [message formatting](#).

SMTP Overview, History and Standards

The [overview and history of the TCP/IP electronic mail system](#) describes how TCP/IP evolved from its early beginnings to its current form. Since the mechanism used to deliver e-mail is such a big part of the system as a whole, any overview of the system must of necessity discuss how delivery mechanisms have changed as well. In the case of TCP/IP, I explained how the delivery of mail evolved through many forms during the 1970s as developers sought to find effective ways of communicating e-mail messages between systems. Most of these efforts involved attempts to transmit mail using existing protocols; this makes sense, since it is easier to adapt a technology than design one from scratch.

Early SMTP History

One important achievement was the publishing of the *Mail Transfer Protocol (MTP)*, which was first defined in RFC 772 in September 1980, then updated in RFC 780 in May 1981. MTP describes a set of commands and procedures by which two devices can connect using TCP to exchange e-mail messages. Its operation is described largely using elements borrowed from two early TCP/IP application protocols that were already in use at that time: [Telnet](#) and [FTP](#). The commands of MTP are in fact based directly on those of FTP.

There wasn't anything inherently wrong with basing e-mail delivery on something like FTP, but defining it this way made MTP somewhat of a “hack”. It was also restricted to the capabilities defined by FTP, a general file transfer protocol, so it was not possible to include features in the protocol that were specific to sending and receiving mail. Due to the importance of e-mail, a specific protocol designed for the purpose of delivering e-mail was warranted. This protocol was first defined in RFC 788, published in November 1981: the *Simple Mail Transfer Protocol (SMTP)*.

The name suggests that SMTP is “simpler” than the “non-simple” MTP that it replaced. Whether this is true or not is somewhat a matter of opinion; I do note that RFC 788 is 61 pages long, while the earlier RFC 780 was only 43 pages. What SMTP definitely has over MTP is **elegance**; the protocol is designed specifically for the transport of electronic mail. While it retains certain similarities to FTP, it is an “independent” protocol running over TCP. So, from a conceptual standpoint, it can be considered simpler than MTP. In terms of mechanics, the process SMTP uses to transfer an e-mail message is indeed rather simple, especially compared to some other protocols.

RFC 788 described the operation of SMTP carrying e-mail messages corresponding to the ARPAnet text message standard as described in RFC 733. Development of both e-mail messages and the SMTP protocol continued, of course. In August 1982, a milestone in TCP/IP e-mail was achieved when RFCs 821 and 822 were published. RFC 821 revised SMTP, and became the defining standard for the protocol for the next two decades. RFC 822, its companion standard, became [the standard for TCP/IP electronic mail messages](#) carried by SMTP.



Key Concept: The most important component of the TCP/IP electronic mail system is the *Simple Mail Transfer Protocol (SMTP)*. SMTP was derived from the earlier Mail Transfer Protocol (MTP), and is the mechanism used for the delivery of mail between TCP/IP systems and users. The only part of the e-mail system for which SMTP is not used is the final retrieval step by an e-mail recipient.

SMTP Extensions and Revisions

As the 1980s progressed and TCP/IP and the Internet both grew in popularity, SMTP gradually overtook other methods to become the dominant method of e-mail message delivery. For a number of years, the protocol was used mostly “as is”, with no new RFCs published to define new versions or formally change its behavior.

This changed in February 1993, when RFC 1425, *SMTP Service Extensions*, was published. As the name suggests, this standard describes a process for adding new capabilities to extend how SMTP works, while maintaining backward-compatibility with existing systems. SMTP with these extensions is sometimes called *Extended SMTP* or *ESMTP* (though use of this term seems to be not entirely universal). As development of

SMTP continued, RFC 1425 was revised in RFC 1651 in July 1994 and then RFC 1869 in November 1995. Along with these, a number of other RFCs defining particular SMTP extensions such as pipelining and message size declaration were defined.

In April 2001, another major milestone in TCP/IP e-mail was reached when revisions of RFC 821 and RFC 822 were published, as RFCs 2821 and 2822 respectively. Both documents are “consolidations” of updates and changes that had been made to RFCs 821 and 822 between 1982 and 2001. And no, I don't think it is a coincidence that the old and new RFC numbers are exactly “2000” apart. RFCs 2820 and 2823 were both published in May 2000, so it looks like 2821 and 2822 were reserved for the e-mail standards. I think this was a great idea, as it makes more clear that the new RFCs are revisions of the old ones.

RFC 2821 is the current base standard for SMTP. It incorporates the base protocol description from RFC 821, and the latest SMTP extensions as defined in RFC 1869. Perhaps more importantly, it updates the description of the e-mail communication model to reflect the realities of modern TCP/IP networks, especially the e-mail features built into the Domain Name System (DNS). We'll examine this in more detail in the next topic.

SMTP Communication and Message Transport Methods, Client/Server Roles and Terminology

The TCP/IP [electronic mail communication model](#) describes the way e-mail messages are conveyed from the sender to the recipient. In most cases, this involves the sender's client machine sending the e-mail to its local SMTP server, which in turn sends it to the recipient's local SMTP server, and finally to the recipient's local host. All of these steps except for the last one are performed by SMTP. In fact, the overall e-mail communication model is largely described by the RFC 821 and 2821 SMTP standards.

The initial communication takes place between the sender's client machine and a local SMTP server that the sender is allowed to access. After submission of the e-mail message, that SMTP server becomes responsible for delivering the message to the SMTP server responsible for the recipient's mailbox. There are two different ways that this can happen.

Early E-Mail Communication Using Relaying

In the first years of electronic mail, when RFC 821 and its predecessors were initially defined, the Internet was very different than it is today. There was no [Domain Name System](#), and this made electronic mail delivery complex, because there was no way to map a mailbox address to the IP address of the SMTP server that managed that mailbox. Also, there were many proprietary networks connected to the Internet, which meant that it was no always possible for any given system to communicate with any other.

Given this, how could e-mail be delivered? The most common way in the early days of SMTP was through a process called *relaying*. SMTP routing information was included along with the e-mail address, to specify a sequence of SMTP servers that the mail should be relayed through to get to its destination. For example, if a sender using SMTP server A wanted to send e-mail to someone whose mailbox was on SMTP server Z, they might have needed to specify that the mail be sent through intermediate SMTP servers at sites D, P

and U to get there. An SMTP connection would be established from A to D to send the message on one leg of its journey; then it would go from D to P, P to U and then U to Z. The process is analogous to [how IP routing](#) works, but at the application layer (actually using IP routing at a lower level, of course.)

You can probably see the problems with this quite easily: it's cumbersome, requires many devices to “handle” the mail, results in delays in communication, and also requires the communication of source routes between SMTP servers. It was certainly functional, but far from ideal.

Modern E-Mail Communication Using DNS and Direct Delivery

The creation of DNS radically changed how e-mail delivery worked. DNS includes support for a special *mail exchanger (MX)* record that allows easy mapping from the domain name in an e-mail address to the IP address of the SMTP server that handles mail for that domain. I explain this in [the topic on the regular e-mail address format](#), as well as [the dedicated topic on DNS e-mail support](#).

In the new system, SMTP communication is much simpler and more direct. The sending SMTP server uses DNS to find the [MX record](#) of the domain to which the e-mail is addressed. This gives the sender the DNS name of the recipient's SMTP server. This is resolved to an IP address, and a connection can be made directly from the sender's SMTP server to the recipient's to deliver the e-mail. While SMTP still supports relaying, direct e-mail delivery using MX records is faster and more efficient, and RFC 2821 makes clear that this is now the preferred method.

In this new system, SMTP is generally only used for two transfers: first, from the sender's client machine to the sender's local SMTP server, and then from that server to the recipient's local SMTP server, as shown in [Figure 301](#). (A distinct [mail access protocol or method](#) is used by the recipient for the last leg of the journey.) Each transfer of an e-mail message between SMTP servers involves the establishment of a TCP connection and then the transfer of the e-mail headers and body using the SMTP mail transfer process. The next two topics describe in detail how this occurs.



Key Concept: In the early days of SMTP, mail was delivered using the relatively inefficient process of relaying from server to server across the internetwork. Today, when an SMTP server has mail to deliver to a user, it determines the server that handles the user's mail using the Domain Name System (DNS) and sends the mail to that server directly.

SMTP Terminology: Client/Server and Sender/Receiver

The original RFC 821 standard referred to the device that initiates an SMTP e-mail transfer as the *sender* and the one that responds to it as the *receiver*. These terms were changed to *client* and *server* in RFC 2821 to “reflect current industry terminology”. Strictly speaking, this is correct, but in some ways the more current terminology is significantly **less** clear.

As I explained in the [general discussion of TCP/IP client/server operation](#), the terms “client” and “server” are used in many different sense in networking, and this often leads to confusion. In common parlance, the computers that handle e-mail on the Internet are usually all called *SMTP servers*. This is for two reasons. First, they run SMTP server software to provide SMTP services to client machines, such as end-user PCs. Second, these devices are usually dedicated hardware servers running in network centers, typically managed by Internet Service Providers.

However, the terms “client” and “server” are now used to refer to the roles in a particular SMTP communication as well. Since all SMTP servers both send and receive e-mail, they all act as both clients and servers transactionally at different times. An SMTP server that is relaying an e-mail will act as both for that message, receiving it as a server and then sending it to the next server as a client.

Adding to this potential confusion is the fact that the initial stage in sending an e-mail is from the sender's client machine to the sender's local SMTP server. Thus, the client role in an SMTP transaction may not be an actual SMTP server, but the server role will always be a server.

Confused yet? ☺ Me too. For all of these reasons, the old terms “sender” and “receiver” are still used in places in RFC 2821, where needed for clarity. I consider them much more straight-forward and use them in the topics that follow.



Key Concept: SMTP servers both send and receive e-mail; the device sending mail acts as a client for that transaction; the one receiving it acts as a server. To avoid confusion, it is easier to refer to the device sending e-mail as the *SMTP sender* and the one receiving as the *SMTP receiver*; these were the terms used when SMTP was originally created.

SMTP Connection and Session Establishment and Termination

The delivery of electronic mail using the Simple Mail Transfer Protocol (SMTP) involves the regular exchange of e-mail messages between SMTP servers. SMTP servers are responsible for sending e-mail that users of the server submit for delivery. They also receive e-mail either intended for local recipients, or in some cases for forwarding or relaying to other servers.

Overview of Connection Establishment and Termination

All SMTP communication is done using the [TCP](#). This allows SMTP servers to make use of TCP's many features that ensure efficient and reliable communication. SMTP servers generally must be kept running and connected to the Internet 24 hours a day, seven days a week, to ensure that mail can be delivered at any time. (This is a big reason why most end-

users employ access protocols such as [POP3](#) to access their received e-mail rather than running their own SMTP servers.) The server listens continuously on the SMTP server port, [well-known port](#) number 25, for any TCP connection requests from other SMTP servers.

As explained in [the previous topic](#), an SMTP server that wishes to send e-mail normally begins with a [DNS lookup](#) of the [MX record](#) corresponding to the domain name of the intended recipient's e-mail address, to get the name of the appropriate SMTP server. This name is then resolved to an IP address; for efficiency, this IP address is often included as an *Additional* record in the response to the MX request, to save the sending server from needing to perform two explicit DNS resolutions.

The SMTP sender then *establishes* a SMTP session with the SMTP receiver. Once the session is established, *mail transactions* can be performed, to allow mail to be sent between the devices. When the SMTP sender is done, it *terminates* the connection. All of these processes involve specific exchanges of commands and replies, which are illustrated in [Figure 304](#).

Connection Establishment and Greeting Exchange

Let's take a look at these processes in more detail, starting of course with SMTP session establishment. The SMTP sender begins by initiating a TCP connection to the SMTP receiver. The sending SMTP server uses an [ephemeral port number](#), since it is playing the role of the client in the transaction. Assuming that the server is willing to accept a connection, it will indicate that it is ready to receive instructions from the client by sending [reply code 220](#). This is called the "greeting" or "service ready" response. It commonly includes the full domain name of the server machine, the version of the SMTP server software it is running, and possibly other information.

Now, it would be rude for the server acting as a client to just start sending commands to the responding server without saying hello first, wouldn't it? So that's exactly what comes next: the client says "hello". In the original SMTP protocol, this is done by issuing a *HELO* command, which includes the domain name of the sending (client) SMTP server as a courtesy. The receiving device then responds back with a return "hello" message using an SMTP reply code 250.

For example, if the SMTP server "smtp.sendersite.org" was making a connection to the SMTP server "mail.receiversplace.com", it would say:

HELO smtp.sendersite.org

After receiving this, "mail.receiversplace.com" would respond back with a "hello" message of its own, something like this:

250 mail.receiversplace.com Hello smtp.sendersite.org, nice to meet you.

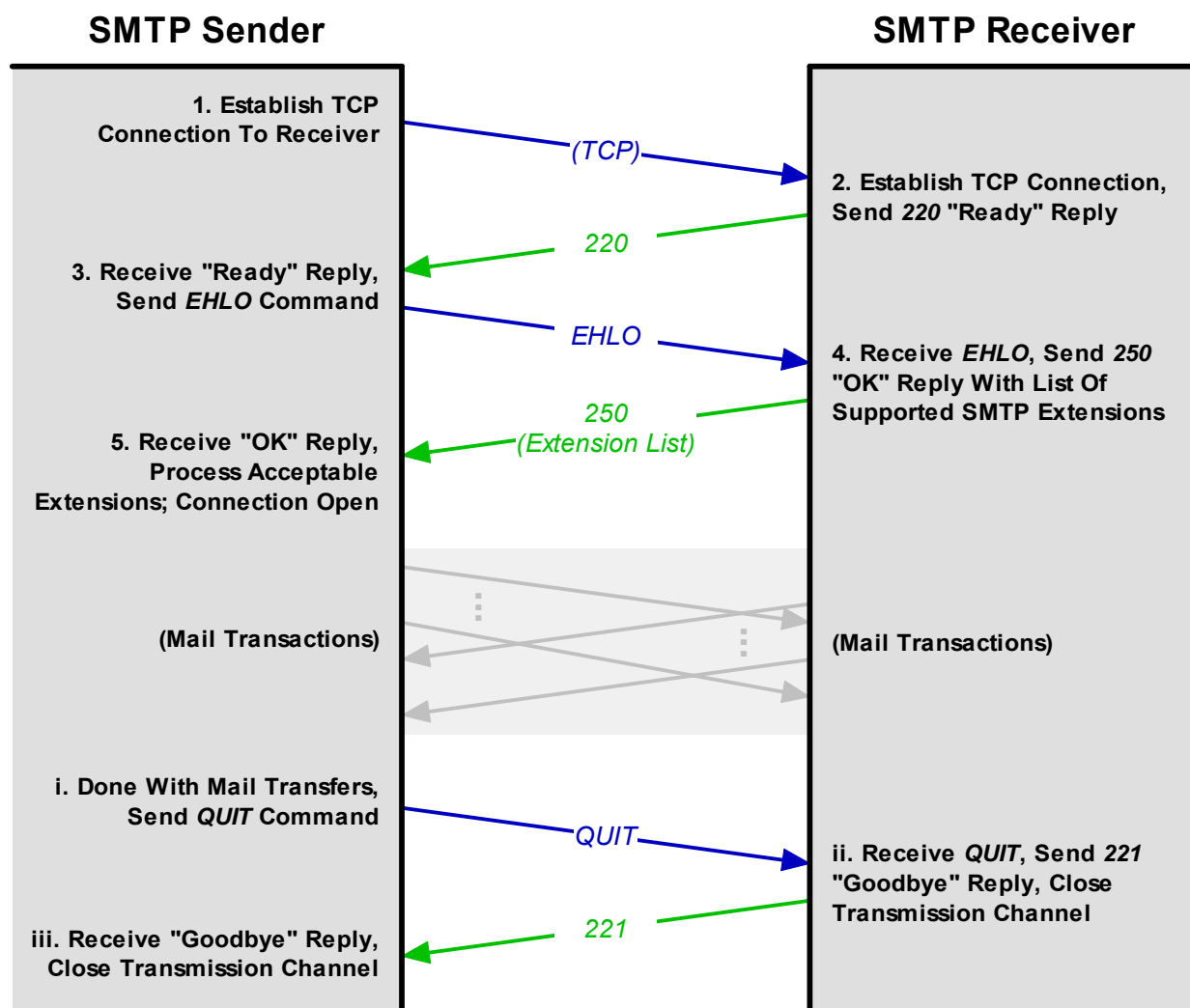

Figure 304: SMTP Transaction Session Establishment and Termination

An SMTP session begins with the SMTP sender establishing a TCP connection to the SMTP receiver. The receiver sends a ready message; the sender sends a *HELO* or *EHLO* command, to which the receiver responds. Assuming no difficulties, the session is established and mail transactions take place. When the sender is done, it sends a *QUIT* command; the receiver responds with a *221* reply and closes the session.

The “chatty” text is of course purely optional; most of the time SMTP communication is between software programs, so all the pleasantries are mostly just programmers having a sense of humor. Still, isn't such politeness a pleasant thing to see in this sometimes difficult world of ours? ☺

Connection Establishment Using SMTP Extensions

The [SMTP extensions](#) defined at first in RFC 1425 and then in subsequent standards up to RFC 2821 define an alternative “hello” message for the client to use: *EHLO* (*extended hello*). An SMTP sender supporting SMTP extensions (and most do) uses *EHLO* instead of *HELO* in response to the *220* greeting. This serves both to say “hello” to the SMTP receiver, and to tell it that the sender supports SMTP extensions.

If the SMTP receiver supports the extensions, it replies back with the usual 250 reply, as well as a series of extra 250 responses. Each of these lists an *EHLO keyword* that indicates a particular SMTP extension the receiver supports. If the receiving server doesn't support the extensions, it will reject the *EHLO* command with a 500 reply code (“syntax error, command not recognized”). This tells the SMTP sender that it cannot use extensions; it will then either issue a conventional *HELO* command, or *QUIT* the connection if it requires the SMTP extensions to be present. (In practice, it is rare for a server to **require** the use of SMTP extensions.)

Here's the same example as above, but using EHLO. The sender says:

```
EHLO smtp.sendersite.org
```

Assuming “mail.receiversplace.com” supports the SMTP extensions, a typical reply might be:

```
250-mail.receiversplace.com Hello smtp.sendersite.org, nice to meet you.  
250-SIZE  
250-DSN  
250 PIPELINING
```

Each of these additional replies identifies a particular SMTP extension supported by “mail.receiversplace.com”; in this case, message size declaration (“SIZE”), delivery status notification (“DSN”) and command pipelining. (The dashes after the “250” indicate a [multiple-line response](#) to a command.)

Once the *HELO* or *EHLO* command has been sent and the receiving device has responded, the session is initiated. Further commands can be sent by the sending SMTP server to the responding server. These usually take the form of e-mail message transfer transactions using the process described in [the following topic](#), and other command/reply exchanges as needed.

Connection Termination

When the sending device is finished sending all the e-mail it has to transfer to the receiving device, and done with all other activities, it terminates the session by issuing the *QUIT* command. This normally results in a 221 “goodbye” message from the SMTP receiver, saying something like “closing transmission channel”. The TCP connection is then terminated.

A server may also terminate prematurely in special cases. If it is given a local command to shut down (for example, due to imminent rebooting of the hardware server upon which it is running), it may respond to any routine command with a 421 response (“Service not available, closing transmission channel”). A server is not supposed to terminate a session simply due to receipt of an invalid command, however, only in special cases where session termination cannot be avoided.



Key Concept: An SMTP session consists of three basic phases. The session is first *established* through the creation of a TCP connection and the exchange of identity information between the SMTP sender and receiver using the *HELO* command.

Once established, *mail transactions* can be performed. When the SMTP sender is done with the session, it *terminates* it using the *QUIT* command. If *SMTP extensions* are supported, the SMTP sender uses the *EHLO (extended hello)* command instead of *HELO*, and the SMTP receiver replies with a list of extensions it will allow the SMTP sender to use.

SMTP Mail Transaction Process

The delivery of e-mail message begins with the [establishment of an SMTP session](#) between the devices sending and receiving the message. The SMTP sender initiates a TCP connection to the SMTP receiver, and then sends a *HELO* or *EHLO* command, to which the receiver responds. Assuming there are no problems, the session is then established and ready for actual e-mail message transactions.

SMTP Mail Transaction Overview

The SMTP mail transaction process itself consists of three steps:

1. **Transaction Initiation and Sender Identification:** The SMTP sender tells the SMTP receiver that it wants to start sending a message, and gives the receiver the e-mail address of the message's originator.
2. **Recipient Identification:** The sender tells the receiver the e-mail address(es) of the intended recipients of the message.
3. **Mail Transfer:** The sender transfers the e-mail message to the receiver. This is a complete e-mail message meeting the [RFC 822 specification](#) (which may be in [MIME](#) format as well).

That's it! So you can see that the word "Simple" in "Simple Mail Transfer Protocol" definitely has at least **some** merit. Especially when compared with other protocols that claim to be simple, such as [SNMP](#). ☺

The Rationale for A Separate E-Mail Message and Envelope

In fact, one question that sometimes comes up when examining SMTP is why couldn't this process be even **simpler**? The first two steps identify the sender of the e-mail and the intended recipient(s). But all of this information is already contained in headers in the message itself. Why doesn't SMTP just read that information from the message, which would in fact make the mail transaction a *one-step* process?

The explanation for this isn't specifically addressed in the SMTP standards, but I believe there are several reasons:

-
- Specifying the sender and recipients separately is more efficient, as it gives the SMTP receiver the information it needs “up front” before the message itself is transmitted. In fact, the SMTP receiver can decide whether or not to accept the message based on the source and destination e-mail addresses.
 - Having this information specified separately gives greater control on how e-mail is distributed. For example, an e-mail message may be addressed to two recipients, but they may be on totally different systems; the SMTP sender might wish to deliver the mail using two separate SMTP sessions to two different SMTP receivers.
 - In a similar vein, there is the matter of delivering blind carbon copies. Someone who is “BCC'ed” on a message must receive it without being mentioned in the message itself.
 - Having this information separate makes implementing security on SMTP much easier.

For these reasons, SMTP draws a distinction between the message itself, which it calls the *content*, and the sender and recipient identification, which it calls the *envelope*. This is of course consistent with our running analogy between regular mail and e-mail. Just as the postal service delivers a piece of mail using only the information written on the envelope, SMTP delivers e-mail using the envelope information and not the content of the message. It's not quite the case that the SMTP server doesn't look at the message itself, just that this is not the information it uses to manage delivery.



Note: It is possible for the sender of a message to generate envelope information based on the contents of the message, but this is somewhat “external” to SMTP itself. It is described in the standard but caution is urged in exactly how this is implemented.

SMTP Mail Transaction Details

Let's take a more detailed look at the SMTP mail transaction process, using as aids the process diagram in [Figure 305](#) and the example transaction of [Table 251](#) (which has commands highlighted in bold and replies in italics). The first two steps in the mail transaction are responsible for providing the receiving SMTP server with the envelope information just discussed. The transaction begins by the SMTP sender issuing a **MAIL** command. This serves to inform the receiver that a new transaction is commencing, and also to tell it the “from” information on the “envelope”. An example:

```
MAIL FROM:<joe@someplace.org>
```

The e-mail address of the originator is always enclosed in angle brackets (“<” and “>”). The SMTP receiver acknowledges the command with a **250** (“OK”) reply message, sometimes sending back the address as a confirmation. For example:

```
250 <joe@someplace.org>... Sender ok
```

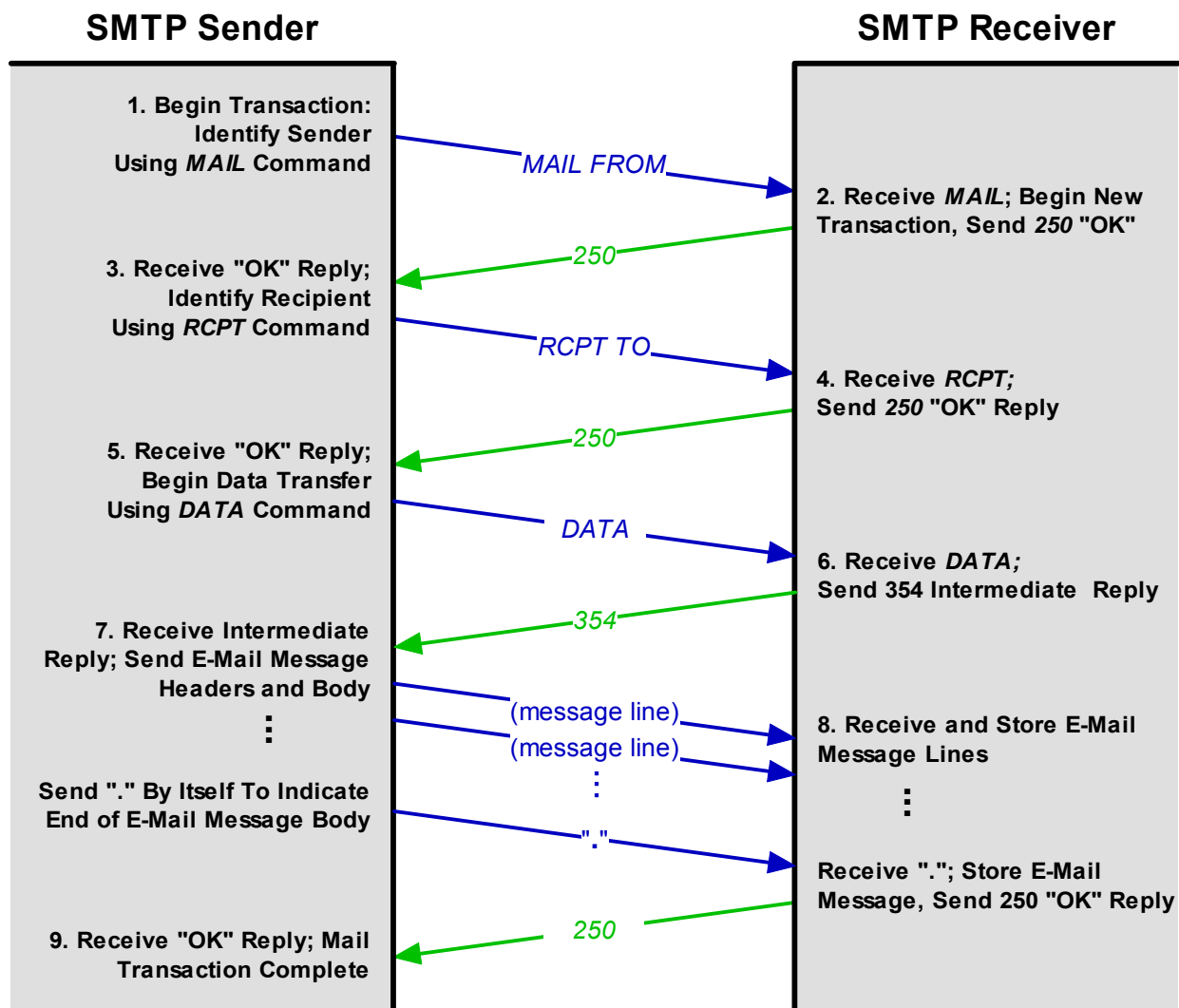

Figure 305: SMTP Mail Transaction Process

Once an SMTP session is established between a sender and receiver, each mail transaction consists of a set of three command/reply sequences. The sender is first identified using the *MAIL* command and the recipients are specified using one or more *RCPT* commands. The actual mail message is then transferred using the *DATA* command, which involves a preliminary reply before the actual message is sent, and a completion reply when it has been fully received.

Next, the SMTP sender uses *RCPT* commands to specify the intended recipients of the e-mail that is being sent. Each *RCPT* line can contain only one recipient, so if multiple recipients are indicated, two or more *RCPT* commands must be issued. Each one normally specifies an e-mail address, but if relaying is being used, the command may contain routing information as well. (As described in [the SMTP communication topic](#), this is not as commonly done as it was in the past.) For example:

```
RCPT TO:<jane@somewhereelse.com>
```

Assuming the server accepts the e-mail, it will give a 250 “OK” reply again, such as this:

```
250 <jane@somewhereelse.com>... Recipient ok
```

The SMTP sender then issues the *DATA* command, which tells the SMTP receiver that the message is coming:

```
DATA
```

The SMTP receiver responds with a 354 “intermediate” reply message, such as this:

```
354 Enter mail, end with "." on a line by itself
```

The SMTP sender then sends the e-mail message, one line at a time, with a single “.” on a line to terminate it. The server confirms the receipt of the message with another 250 “OK” reply, and the transaction is done.

Table 251: Example SMTP Mail Transaction

```
MAIL FROM:<joe@someplace.org>
250 <joe@someplace.org>... Sender ok
RCPT TO:<jane@somewhereelse.com>
250 <jane@somewhereelse.com>... Recipient ok
DATA
354 Enter mail, end with "." on a line by itself
From: Joe Sender <joe@someplace.org>
To: Jane Receiver <jane@somewhereelse.com>
Date: Sun, 1 Jun 2003 14:17:31 -0800
Subject: Lunch tomorrow

Hey Jane,

It's my turn for lunch tomorrow. I was thinking we could
[rest of message]
Hope you are free. Send me a reply back when you get a chance.
Joe.
.
250 OK
```



Key Concept: After an SMTP session is established, e-mail messages are sent using the SMTP *mail transaction process*. The SMTP sender starts the transaction by identifying the sender of the e-mail, and then specifying one or more recipients. The e-mail message itself is then transmitted to the SMTP receiver. Each e-mail to be sent is a separate transaction.

Potential Mail Transaction Complications

While this indeed is quite simple, I should point out that I have only shown an e-mail from a sender to one recipient, and the case where there are no problems or complications in the transaction. Due to either command syntax or server issues, it is possible for various types of errors to occur at different stages of the process, which may result in the transaction failing. There are also [security concerns](#) that may come into play, that may lead to restrictions in what transactions a server may allow.

SMTP Special Features, Capabilities and Extensions

The primary job of the Simple Mail Transfer Protocol is of course to implement the TCP/IP electronic mail delivery system. Whenever the user of an SMTP server gives it an e-mail message addressed to a non-local mailbox, the server will attempt to transfer it to the appropriate destination server, using the [SMTP mail transaction process](#). Many billions of such transfers are performed every day on the Internet, allowing e-mail to quickly reach its destination anywhere around the world.

SMTP Special Features

In addition to the basic mail transfer mechanism, SMTP includes a number of other features and capabilities. These allow SMTP to support special requirements and auxiliary needs of the mail system, and are described in detail in RFC 2821. It would take many topics to describe them all in detail, so I will just provide a quick summary of the more important ones here so you know a bit about them:

- ☉ **Mail Relaying:** As discussed in the [SMTP communication overview](#), the protocol was once widely used in a “relaying mode” where e-mail was routed from one SMTP server to another to reach its destination. Today, the normal method of e-mail transfer on the Internet today is directly from the sender's SMTP server to the recipient's, using [DNS MX records](#) to determine the recipient SMTP server address. SMTP still includes the ability to relay mail from one server to another, provided certain conditions are met. Note that in addition to the inefficiency of relaying, many servers won't relay mail because this feature has been [abused for spamming and hacking](#).
- ☉ **Mail Forwarding:** Under certain conditions, an SMTP server may agree to accept e-mail for a non-local mailbox and forward it to the appropriate destination. This sounds similar to relaying but is used in a different way. A common example is when a user changes his or her e-mail address. If I have worked at XYZ Industries for years and then retire, the company may no longer wish to let me receive e-mail at the company's SMTP server. As a courtesy, however, they may forward e-mail sent to me there so I still receive it at my new company.
- ☉ **Mail Gatewaying:** Certain SMTP servers may be configured as e-mail gateways. These devices “translate” TCP/IP e-mail into a form suitable for another e-mail system, and vice-versa. Gatewaying is a complex topic because e-mail systems can be so different; one of the more important problems is the [inconsistency of addressing methods of different e-mail systems](#).
- ☉ **Address Debugging:** SMTP includes a *VERFY* (*verify*) command, which can be used to check the validity of an e-mail address without actually sending mail to it.

- ☉ **Mailing List Expansion:** The SMTP command *EXPN* (*expand*) can be used to determine the individual e-mail addresses associated with a [mailing list](#). (Note however that this has nothing directly to do with mailing list software like *Majordomo*.)
- ☉ **“Turning”:** The original SMTP protocol included a command that allows the SMTP sender and SMTP receiver to change roles. This could be used to allow SMTP server A to send e-mail to server B, and then have B send e-mail it has queued for A in the same session. In practice, this capability was not widely used for a variety of reasons, including security considerations. It is now officially “not recommended”, but may still be implemented in some SMTP software.

Other Capabilities and Functions of SMTP Servers

The list above represents just a few of the features that are mentioned in the SMTP standards. In addition to these, a given type of SMTP server software may be given other features as well by its developers. The *HELP* command is one way to determine what some of the commands that a given SMTP server supports.

SMTP servers also must perform a great deal of “background processing” that doesn't get a great deal of attention. This includes managing connections, checking for errors in commands and e-mail messages, and reacting accordingly. They must also be on the lookout for problem conditions, such as “looping” that may result in an e-mail message being passed back and forth between two SMTP servers, each thinking the other is the intended recipient. In the event of an initial failure to deliver mail, SMTP servers are also required to periodically retry communication with the destination device, and return a failure message to the sender if it cannot deliver the message after a certain period of time. Again, RFC 2821 contains more details.

SMTP Extensions

As discussed earlier in this section, during the 1990s many extensions to the basic operation of SMTP were defined. These are enabled when two SMTP servers supporting the extension [set up a session](#) using the *EHLO* command and appropriate extension response codes. [Table 252](#) summarizes some of the more interesting SMTP extensions that have been defined, and gives the RFC number where each is described.

Table 252: SMTP Extensions (Page 1 of 2)

Extension Keyword	Extension	Defining Document	Description
8BITMIME	8-bit MIME support.	RFC 1652	Theoretically defines support for the 8-bit content transfer encoding type in MIME, but there are complications associated with this. See the discussion of content encoding in the MIME section.
AUTH	Authorization	RFC 2554	Used to implement an authorization mechanism for servers requiring enhanced security.

Table 252: SMTP Extensions (Page 2 of 2)

Extension Keyword	Extension	Defining Document	Description
DSN	Delivery status notification	RFC 1891	Allows an SMTP sender to request that the SMTP receiver notify it a problem occurs in delivering a message the sender gives to it.
ENHANCED-STATUSCODES	Enhanced status codes. (They should have abbreviated the keyword. ☺)	RFC 2034, RFC 1893	Extends the traditional 3-digit SMTP reply code format with extra codes that provide more information. See the end of the topic on SMTP replies for more.
PIPELINING	Command pipelining	RFC 2920	Allows multiple commands to be transmitted in batches from the SMTP sender to the receiver, rather than sending one command at a time and waiting for a response code.
SIZE	Message size declaration	RFC 1870	Allows information about the size of a message to be declared by an SMTP sender prior to transmitting it, so the SMTP receiver can decide if it wants the message or not.



On The Web: The full current set of SMTP extensions can be found here: <http://www.iana.org/assignments/mail-parameters>



Note: Certain commands in the basic SMTP protocol description that are considered optional are also sometimes considered extensions, such as the *EXPN* and *HELP* commands; I have not listed these here since they are not true SMTP extensions.

SMTP Security Issues

If you've already read the sections describing other TCP/IP protocols such as [DHCP](#), [FTP](#) and so forth, you probably already know how I am going to start this section. The theme is a common one in TCP/IP: a lack of security in how a protocol is implemented. And this all goes back to a common root cause: most of these protocols were developed when the "Internet" was just a small group of machines controlled by individuals who mostly knew and trusted each other, or who were able to use physical security means. Developers never imagined TCP/IP being used by millions of anonymous "average Joe" users around the world, which necessitates far more attention to security than a small research internetwork like the ARPAnet.

When it comes to SMTP, security matters are if anything **worse** than they are with the other protocols I mentioned above. Not only does SMTP not have any real security mechanism, the original [relaying model of SMTP communication](#) is entirely designed around the idea of “cooperation” and “trust” between servers. Since most SMTP servers would be asked to handle a certain number of intermediate transfers, each server was required to accept mail from any originator to be delivered to any destination.

The basic assumption in this model is that SMTP servers would all be “well-behaved”, and not abuse the system by flooding intermediate servers with lots of mail to be delivered, or sending bogus messages to cause problems. This all changed as the Internet exploded in popularity in the 1990s. Con artists, hackers, and disreputable salespeople all discovered that e-mail could be used for “free” delivery of messages simply by submitting them to an SMTP server for delivery. The result was overloaded servers, primarily due to the sending of large quantities of unwanted e-mail, which Internet users commonly call *spam*.



Note: The term “spam”, in this context, does not have anything directly to do with the Hormel processed meat product. Its use in reference to massive amounts of e-mail comes from a Monty Python comedy sketch where that word is repeated over and over again.

It is actually very easy to “impersonate” an SMTP server. You can use the [Telnet Protocol](#) to connect directly to an SMTP server on port 25. [SMTP commands](#) are all sent as text, and so are [SMTP replies](#), so you can have a “conversation” with a server and even manually perform a mail transaction. This is useful for debugging, but also makes abuse of a wide open SMTP server trivially easy. Since spammers often don't want to be identified, they employ spoofing techniques to make it more difficult to identify them, which makes matters even more difficult.

Common SMTP Server Security Techniques

Despite this obvious problem, efforts to implement a general security mechanism in SMTP have been resisted for two main reasons. First, there is no foolproof way to retrofit a new security mechanism onto something as widely used as SMTP without creating incompatibilities between newer and older systems. Second, many administrators were reluctant to completely do away with the general notion of cooperation between sites that has helped make the Internet so successful, simply due to a few “bad apples”.

Still, something had to be done. The compromise was for system administrators to “tighten up” their SMTP servers through the imposition of both technical and policy changes. Naturally, these vary from one organization to another. Some of the more common SMTP security provisions include:

- ☉ Checking the IP address of a device attempting connection and refusing to even start an SMTP session unless it is in a list of authorized client devices.

-
- ☉ Restriction of certain commands or features, such as e-mail relaying, to authorized users or client servers. This is sometimes done by requiring authentication via the [SMTP extension AUTH](#) before the command will be accepted.
 - ☉ Limiting the use of commands such as *EXPN* to prevent unauthorized users from determining the e-mail addresses of users on mailing lists.
 - ☉ Checking the validity of envelope information before accepting a message for delivery. Some servers will first verify that the originator's e-mail address is valid before agreeing to accept the *MAIL* command. Many will check the recipient's address and refuse the message if delivery is not to a local mailbox. Others use even more advanced techniques.
 - ☉ Limiting the size of e-mail messages that may be sent or the number that may be sent in a given period of time.
 - ☉ Logging all access to the server to keep records of server use and check for abuse.

Because of all the abuse in recent years, you will find that most SMTP servers implement these or other features, even though most of those features are not formally defined by the SMTP standards. They are instead enhancements built into individual SMTP server software packages.

Some of these measures can actually get quite sophisticated. For example, the SMTP server run by pair Networks, the great Web hosting company I have used for years, uses “POP-before-SMTP authentication”. This means that before the server will accept outgoing mail from the user via SMTP, the user must first log in to check incoming mail using the [Post Office Protocol](#). Since POP includes authentication, successful POP login tells the server the user is authorized. This “flips a switch” in the server that allows the user to access the SMTP service after that login for a limited period of time. If this seems convoluted, well, you start to get an idea of the hassle that spammers and hackers have created for Internet service providers today.

It's also worth noting that SMTP does not include any mechanism for encryption to ensure the privacy of e-mail transmissions. Users requiring security in who sees their messages must use a separate encryption scheme to encode the body of the message prior to submission.



Key Concept: SMTP was designed in an era where internet security was not much of an issue; as a result, the base protocol includes no security mechanism at all. Since e-mail is so often abused today, most modern SMTP servers incorporate one or more security features to avoid problems.

SMTP Commands

I mentioned in [the overview and history of SMTP](#) that early TCP/IP e-mail mechanisms were developed by borrowing techniques and elements from existing application protocols, especially [Telnet](#) and [FTP](#). SMTP is an independent protocol, but its heritage can still be seen clearly in a few areas. One of the more obvious of these is in the method by which commands are issued by an SMTP sender and replies returned by an SMTP receiver.

Like FTP, all SMTP commands are sent as plain ASCII text over the TCP connection established between the client and server in an SMTP connection. These commands must end with the two-character “CRLF” sequence that normally terminates ASCII text as required for the Telnet [Network Virtual Terminal \(NVT\)](#). In fact, you can check the function of an SMTP server and even issue commands to it yourself, simply by using Telnet to connect to it on port 25.

SMTP Command Syntax

All SMTP commands are specified using a four-letter *command code*. Some commands also either allow or require *parameters* to be specified. The basic syntax of a command is:

<command-code> <parameters>

When parameters are used, they follow the command code and are separated from it by one or more space characters. For example, the *HELO* and *EHLO* commands are specified with the command code, a space character, and then the domain name of the SMTP sender, as we saw in our look at [SMTP connection establishment](#).

Current SMTP Commands

[Table 253](#) lists the commands currently used in modern SMTP, in the order they are described in RFC 2821, with a brief description of each.

Table 253: SMTP Commands (Page 1 of 2)

Command Code	Command	Parameters	Description
<i>HELO</i>	Hello	The domain name of the sender.	The conventional instruction sent by an SMTP sender to an SMTP receiver to initiate the SMTP session.
<i>EHLO</i>	Extended Hello	The domain name of the sender.	Sent by an SMTP sender that supports SMTP extensions to greet an SMTP receiver and ask it to return a list of SMTP extensions the receiver supports. The domain name of the sender is supplied as a parameter.

Table 253: SMTP Commands (Page 2 of 2)

Command Code	Command	Parameters	Description
MAIL	Initiate Mail Transaction	Must include a "FROM:" parameter specifying the originator of the message, and may contain other parameters as well.	Begins a mail transaction from the sender to the receiver.
RCPT	Recipient	Must include a "TO:" parameter specifying the recipient mailbox, and may also incorporate other optional parameters.	Specifies one recipient of the e-mail message being conveyed in the current transaction.
DATA	Mail Message Data	None	Tells the SMTP receiver that the SMTP sender is ready to transmit the e-mail message. The receiver normally replies with an intermediate "go ahead" message, and the sender then transmits the message one line at a time, indicating the end of the message by a single period on a line by itself.
RSET	Reset	None	Aborts a mail transaction in progress. This may be used if an error is received upon issuing a <i>MAIL</i> or <i>RCPT</i> command, if the SMTP sender cannot continue the transfer as a result.
VERFY	Verify	E-mail address of mailbox to be verified.	Asks the SMTP receiver to verify the validity of a mailbox.
EXPN	Expand	E-mail address of mailing list.	Requests that the SMTP server confirm that the address specifies a mailing list, and return a list of the addresses on the list.
HELP	Help	Optional command name.	Requests help information: general help if no parameter is supplied, otherwise information specific to the command code supplied.
NOOP	No Operation	None	Does nothing except for verifying communication with the SMTP receiver.
QUIT	Quit	None	Terminates the SMTP session.

Like [FTP commands](#), SMTP commands are not case sensitive.

Certain SMTP extensions make changes to the basic SMTP command set. For example, the *AUTH* extension specifies a new command (also called *AUTH*) that specifies an authentication method the SMTP client wants to use. Other extensions define new parameters for existing commands. For example, the *SIZE* extension defines a *SIZE* parameter that can be added to a *MAIL* command to tell the SMTP receiver the size of the message to be transferred.



Key Concept: The SMTP sender performs operations using a set of *SMTP commands*. Each command is identified using a four-letter code. Since SMTP only supports a limited number of functions, it has a small command set.

Obsolete SMTP Commands

The commands in the preceding table are the ones that are most commonly used in SMTP today. In addition to those, there are also certain commands that were originally defined in RFC 821 but have since become obsolete. These include the following:

- ☉ **SEND, SAML (“send and mail”) and SOML (“send or mail”):** RFC 821 defined a distinct mechanism for delivering mail directly to a user's terminal as opposed to a mailbox, optionally in combination with conventional e-mail delivery. These were rarely implemented and obsoleted in RFC 2821.
- ☉ **TURN:** Reverses the role of the SMTP sender and receiver as described in the [SMTP special features topic](#). This had a number of implementation and security issues and was removed from the standard in RFC 2821.

SMTP Replies and Reply Codes

SMTP communication begins with the establishment of an [SMTP session](#) between an SMTP sender (the device acting as a client) and an SMTP receiver (the device acting as a server). All protocol operations then consist of plain ASCII text [SMTP commands](#) issued by the sender to the receiver. The receiver analyzes each command, carries out the instruction requested by the sender if possible, and then responds back with a reply to the sender. The reply serves several functions: confirming command receipt; indicating if the command was accepted or not; and communicating the result of processing the command.

Just as SMTP commands are sent in a manner reminiscent of how [FTP internal commands](#) work, SMTP replies are formatted and interpreted in a way almost identical to that of [FTP replies](#). As with FTP, the reply consists not just of a string of reply text, but a combination of reply text and a numerical *reply code*. And as with FTP, these reply codes use three digits to encode various information about the reply, with each digit having a particular significance. The reply code is really the key part of the reply, with the reply text being merely descriptive.



Note: The [topic on FTP reply codes](#) contains a thorough explanation of the benefits of using these structure numeric reply codes. Since the SMTP system is so similar, I won't duplicate that discussion in this topic. I will, however, fully describe the syntax and semantics of SMTP reply codes here, in order both to keep this section on SMTP self-contained, and to indicate where the differences are between FTP and SMTP reply codes.

Reply Code Structure and Digit Interpretation

SMTP reply codes can be considered to be of the form “xyz”, where “x” is the first digit, “y” the second and “z” the third. Here is how these digits are used.

First Reply Code Digit (“x”)

The leading reply code digit indicates the success or failure of the command in general terms, whether a successful command is complete or incomplete, and whether an unsuccessful one should be tried again or not. This particular digit is interpreted in exactly the same way as it is in FTP, as shown in [Table 254](#).

Table 254: SMTP Reply Code Format: First Digit Interpretation

Reply Code Format	Meaning	Description
1yz	Positive Preliminary Reply	An initial response indicating that the command has been accepted and processing of it is still in progress. The SMTP sender should expect another reply before a new command may be sent. Note that while this first digit type is formally defined in the SMTP specification for completeness, it is not currently actually used by any of the SMTP commands. That is to say, there are no reply codes between 100 and 199 in SMTP.
2yz	Positive Completion Reply	The command has been successfully processed and completed.
3yz	Positive Intermediate Reply	The command was accepted, but processing of it has been delayed, pending receipt of additional information. One example of where this type of reply is often made is after receipt of a <i>DATA</i> command, to prompt the SMTP sender to then send the actual e-mail message to be transferred.
4yz	Transient Negative Completion Reply	The command was not accepted and no action was taken, but the error is temporary and the command may be tried again. This is used for errors that may be a result of temporary glitches or conditions that may change, such as a resource on the SMTP server being temporarily busy.
5yz	Permanent Negative Completion Reply	The command was not accepted and no action was taken. Trying the same command again is likely to result in another error. An example would be sending an invalid command.

Second Reply Code Digit (“y”)

The middle digit categorizes messages into functional groups. This digit is used in the same general way as in FTP, but some of the functional groups are different in SMTP, as you can see in [Table 255](#).

Table 255: SMTP Reply Code Format: Second Digit Interpretation

Reply Code Format	Meaning	Description
x0z	Syntax	Syntax errors or miscellaneous messages.
x1z	Information	Replies to requests for information, such as status requests.
x2z	Connections	Replies related to the connection between the SMTP sender and SMTP receiver.
x3z	Unspecified	Not defined.
x4z	Unspecified	Not defined.
x5z	Mail System	Replies related to the SMTP mail service itself.

Third Reply Code Digit (“z”)

The last digit indicates a specific type of message within each of the functional groups described by the second digit. The third digit allows each functional group to have 10 different reply codes for each reply type given by the first code digit (preliminary success, transient failure and so on.)

Combining Digit Values to Make Specific Reply Codes

Again, as in FTP, these “x”, “y” and “z” digit meanings are combined to make specific reply codes. For example, the reply code “250” is a positive reply indicating command completion, related to the mail system. It usually is used to indicate that a requested mail command was completed successfully.

Common SMTP Reply Codes

[Table 256](#) contains a list of some of the more common SMTP reply codes taken from RFC 2821, in numerical order. For each, I have shown the “typical” reply text specified in the standard, and provided additional descriptive information where I felt it was needed.

Table 256: SMTP Reply Codes (Page 1 of 3)

Reply Code	Reply Text	Description
211	System status or system help reply.	
214	<Help message...>	Used for text sent in reply to the <i>HELP</i> command.

Table 256: SMTP Reply Codes (Page 2 of 3)

Reply Code	Reply Text	Description
220	<servername> Service ready.	Greeting message sent when TCP connection is first established to an SMTP server.
221	<servername> closing transmission channel.	Goodbye message sent in response to a <i>QUIT</i> message.
250	Requested mail action okay, completed	Indicates successful execution of a variety of commands.
251	User not local; will forward to <forward-path>	Used when the SMTP receiver agrees to forward a message to a non-local user.
252	Cannot VRFY user, but will accept message and attempt delivery	Indicates that a server tried to verify an e-mail address, but was not able to do so completely. Usually means the address appears to be valid but it was not possible to positively ascertain this to be true.
354	Start mail input; end with <CRLF>.<CRLF>	Intermediate reply to a <i>DATA</i> command.
421	<servername> Service not available, closing transmission channel	Sent in response to any command when the SMTP receiver prematurely terminates the connection. A common reason for this is receipt of a local shutdown command, due for example to a hardware reboot.
450	Requested mail action not taken: mailbox unavailable	Sent when a mailbox is busy due to another process accessing it.
451	Requested action aborted: local error in processing	Local processing problem on the server.
452	Requested action not taken: insufficient system storage.	Time to clean out the server's hard disk! ☺
500	Syntax error, command unrecognized	Response to a bad command or one that was too long.
501	Syntax error in parameters or arguments	
502	Command not implemented	Command is valid for SMTP in general but not supported by this particular server.
503	Bad sequence of commands	Commands were not sent in the correct order, such as sending the <i>DATA</i> command before the <i>MAIL</i> command.
504	Command parameter not implemented.	
550	Requested action not taken: mailbox unavailable	Generic response given due to a problem with a specified mailbox. This includes trying to send mail to an invalid address, refusal to relay to a non-local mailbox and so forth.
551	User not local; please try <forward-path>	Tells the SMTP sender to try a different path; may be used to support mailbox forwarding.

Table 256: SMTP Reply Codes (Page 3 of 3)

Reply Code	Reply Text	Description
552	Requested mail action aborted: exceeded storage allocation	User's mailbox is full.
553	Requested action not taken: mailbox name not allowed	Specification of an invalid mailbox address.
554	Transaction failed.	General failure of a transaction.

As mentioned before, the actual text string for each reply code is implementation-specific. While the standard specifies “dry” response text such as “Requested action completed” for a 250 message, some servers customize this code, or even give different replies to different 250 messages depending on context. Again, there are examples of this in other topics.

SMTP Multiple-Line Text Replies

Again, as in FTP, it is possible for a reply to contain more than one line of text. In this case, each line starts with the reply code, and all lines but the last have a hyphen between the reply code and the reply text, to indicate that the reply continues. The last line has a space between the reply code and text, just like a single-line reply. An example of this was given in [the topic on SMTP connections](#) where I showed a multi-line response to a *EHLO* command.

Enhanced Status Code Replies

When the *ENHANCEDSTATUSCODES* SMTP extension is enabled, this causes supplemental reply codes to be issued by the SMTP receiver in response to each command. These codes are similar in some respects to the standard reply codes; they also use three digits, but the digits are separated by periods. These enhanced codes provide more information about the results of operations, especially errors.

For example, if you try to issue a *RCPT* command specifying a non-local mailbox on a server not supporting this feature, it will send back a “550” reply, which is a generic error (“requested action not taken: mailbox unavailable”). When enhanced status codes are active, the response will be “550 5.7.1”, the more specific message “delivery not authorized, request refused”. A full description of these enhanced codes can be found in RFC 1893.



Key Concept: Each time the SMTP sender issues a command, it receives a *reply* from the SMTP receiver. SMTP replies are similar to FTP replies, using both a three-digit reply code and a descriptive text line. A special *enhanced status codes* SMTP extension is also defined; when enabled, this causes the SMTP receiver to return more detailed result information after processing a command.



TCP/IP Electronic Mail Access and Retrieval Protocols and Methods

The [Simple Mail Transfer Protocol \(SMTP\)](#) is responsible for most of the process of sending an e-mail message from the originator to the recipient. SMTP's job ends when the message has been successfully deposited into the recipient's mailbox on his or her local SMTP server.

In some cases this mailbox is the end of the message's travels through cyberspace. More often, however, it is only a “rest stop”—the last step of the journey is for the message to be actually accessed and read by the user to whom it was sent. This may require that it be retrieved from the mailbox and transferred to another client machine. For a [variety of reasons](#), SMTP is not used for the process of accessing a mailbox, but rather a special set of protocols and methods designed specifically for *electronic mail access and retrieval*.

In this section, I describe some of the more common techniques used for TCP/IP e-mail access and retrieval. I begin with an overview of the subject that describes in general the different paradigms used for e-mail access and gives an overview of the protocols. I then have subsections that cover the two mail TCP/IP e-mail access and retrieval protocols: the Post Office Protocol (POP) and the Internet Message Access Protocol (IMAP). I also have a third, smaller subsection that discusses other methods of e-mail access.

Note that this section assumes that you already have familiarity with SMTP and the operation of the TCP/IP e-mail system as a whole.

TCP/IP Electronic Mail Mailbox Access Model, Method and Protocol Overview

In an ideal world... we would all be born knowing everything there is to know about computers and networking, and I'd have become a famous novelist instead of writing thousands of pages of this stuff. ☺ Well, that may be asking a bit **too** much, but wouldn't it have been nice if every device on the Internet simply ran SMTP server software? If so, then that one protocol would be sufficient to implement the entire TCP/IP e-mail system. You would just compose e-mail on your machine, and your SMTP software would send it to your recipient's, and he or she would read it. Nice and simple.

Back here in the real world, however, this is really not possible in general terms. As I explained in [the overview section on e-mail](#) and [the discussion of SMTP](#), an SMTP server must be connected to the Internet and available around the clock to receive e-mail sent at any time by any of the millions of other computers in the world. Most of us either cannot or do not want to run machines continuously connected to the Internet, nor do we want to configure and maintain potentially-complex SMTP software. This is the reason why a complete e-mail exchange normally involves **not two devices but four**: a message is composed on the sender's client machine, transferred to the sender's SMTP server, then to the recipient's SMTP server, and finally, to the recipient's machine.

The Advantages of Specialized Mail Access and Retrieval Protocols

The communication between SMTP servers is of course done with SMTP. So is the initial step of sending the e-mail from the sender's machine to the sender's SMTP server. However, SMTP is **not** used for the last part of the process, accessing the recipient's mailbox. Instead, a set of *mailbox access and retrieval* protocols and methods were devised.

A fair question is... why was this done? Why not simply have mail sit “pending” on the recipient's SMTP server and then have it send the mail to the recipient client device when it comes online, using SMTP? There are two main reasons for this. The first is that SMTP was designed for the specific purpose of transporting e-mail only. Having it responsible for client mailbox access would require adding more functionality, making it difficult to keep SMTP “simple”. Also, SMTP works on a “push” model, with transactions being initiated by the sender. It would need changes to allow it to respond to requests from a client device that is only online intermittently.

But the second reason is probably more important: *flexibility* in how electronic mail is accessed. If we used SMTP, all we would be able to do is transfer e-mail to the recipient's client machine. This would be functional, but would greatly limit the capabilities of how e-mail is used. For example, some users might wish to access mail directly on the server and manipulate it there. Also consider the problem of people with special requirements, such as those who travel and may need to access e-mail from a number of different client devices.

E-Mail Access and Retrieval Models

For the reasons just examined, there is an advantage to providing more than one way to access a mailbox. RFC 1733, *Distributed Electronic Mail Models In IMAP4*, describes three different paradigms or models for mail access and retrieval:

- ☺ **Online Access Model:** This is the mode of access that we would all be using in my “ideal world” scenario, where every machine was always connected to the Internet running an SMTP server. You would have constant, direct online access to your mailbox. In the real world, this model is still used by some Internet users, especially those who have UNIX accounts or run their own SMTP servers. I call this *direct server access*.
- ☺ **Offline Access Model:** In this paradigm, a user establishes a connection to a server where his or her mailbox is located. The user downloads received messages to the client device, and then deletes them from the server mailbox. All reading and other activity performed on the mail can be done “offline” once the mail has been retrieved.
- ☺ **Disconnected Access Model:** This is a hybrid of online and offline access. The user downloads messages from the server, so he or she can read or otherwise manipulate them without requiring a continuous connection to the server. However, the mail is *not* deleted from the server, like in the offline model. At some time in the future, the user connects back with the server and synchronizes any changes made on the local device with the mailbox on the server.

What sort of changes? Examples include marking whether or not a message has been read, to keep track of unread mail, and marking messages to which the user has already replied. These are important tools to help those with busy mailboxes keep track of what they need to do.

Comparing E-Mail Access and Retrieval Models

Of the three, which is best? You should know better than to ask me that question. ☺ Each has advantages and disadvantages, which is why it is good that we have these options rather than the single SMTP protocol for mail access.

[Direct server access](#) has the main benefits of instant speed and universal access from any location. It has the disadvantage that you must be online to read mail, and that it usually requires you to use UNIX e-mail clients that most people are not familiar with. However, the [Internet Message Access Protocol \(IMAP\)](#) can also be used for online access.

Offline access has the main advantages of simplicity and short connection time requirements; you can easily connect to the mailbox, download messages and then read them locally. But that makes this method somewhat inflexible, and poorly-suited to access from different machines. Still, it is right now the most popular access method, because simplicity is important; it is best typified by the popular [Post Office Protocol \(POP\)](#).

Disconnected access attempts to combine the advantages of offline and online access without combining their disadvantages, and does a pretty good job. The advantages are significant: the ability to quickly access mail and use it offline, while retaining and updating the mailbox on the server to allow access from different client machines. [IMAP](#) is the

protocol popularly used for disconnected access. In the [IMAP overview](#) I explore its advantages over offline access, as well as its main disadvantages: complexity and far less universal support than POP (though acceptance of IMAP is slowly increasing).

Finally, in recent years, a somewhat new mailbox access method has become popular: [e-mail access using the World Wide Web](#). This technique allows a user to access his or her mailbox from any computer with an Internet connection and a Web browser. It is a good example of “line blurring”, not only between the access models discussed here, but between TCP/IP applications, in this case [the Web](#) and e-mail.



Key Concept: For flexibility, TCP/IP uses a variety of *mailbox access and retrieval protocols and methods* to allow users to read e-mail. Three different models describe how these different methods work: the *online* model, in which e-mail is accessed and read on the server; the *offline* model, in which mail is transferred to the client device and used there; and the *disconnected* model, where mail is retrieved and read offline but remains on the server with changes synchronized for consistency.



TCP/IP Post Office Protocol (POP/POP3)

The [overall communication model](#) used for TCP/IP e-mail gives many options to an e-mail user for accessing his or her electronic mailbox. The most popular access method today is the simple *offline* access model, where a client device accesses a server, retrieves mail and deletes it from the server. The *Post Office Protocol (POP)* was designed for quick, simple and efficient mail access; it is used by millions of people to access billions of e-mail messages every day.

In this section I describe the operation of the Post Office Protocol, focusing on version 3 (POP3). I begin by looking at the protocol in general terms, discussing its history, the various versions of the protocol and the standards that define them. I describe POP3's general operation and the communication between a client and server, concentrating on the three main states through which the session transitions. I then describe each of these states in sequence: the *Authorization* state, *Transaction* state and *Update* state. For each, I explain the communication processes that take place and the commands and replies that implement them.

POP Overview, History, Versions and Standards

Of the three [mailbox access paradigms](#), *online*, *offline* and *disconnected*, the offline model is probably the least capable in terms of features. And it is also the most popular! This may **seem** counter-intuitive, but it is in fact a pattern that repeats itself over and over in the worlds of computing and networking: a good example would be Ethernet beating Token Ring in the LAN market. The reason is that *simplicity* and *ease of implementation* are keys to the success of any technology, and the offline mail access model beats the other two in these areas.

The history of offline e-mail access goes back farther than one might expect—to the early 1980s. Two decades ago, we didn't have nearly everyone and his brother accessing the Internet to check e-mail the way we do today. In fact, there were only a relatively small number of machines connected using TCP/IP, and most users of these machines had the ability to access their e-mail on-server, using the online access model.

However, even back then, developers recognized the advantages of being able to retrieve e-mail from a server directly to a client computer, rather than accessing the mailbox on the server using [Telnet](#) or [NFS](#). In 1984, RFC 918 was published, defining the *Post Office Protocol (POP)*. The idea behind POP was to provide a simple way for a client computer to retrieve e-mail from a mailbox on an SMTP server so it could be used locally.

The emphasis was on **simple**; the RFC for this first version of POP is only 5 pages long, and the standard it defined is extremely rudimentary. It describes only a simple sequence of operations where a user gives a name and password for authentication, and then downloads the entire contents of a mailbox. Simple is good, but there are limits.

In February 1985, RFC 937 was published: *Post Office Protocol - Version 2*. POP2 expanded the capabilities of POP by defining a much richer set of commands and replies. This includes the important ability of being able to read only certain messages, rather than dumping a whole mailbox. Of course, this came at the cost of a slight increase in protocol complexity, but POP2 was still quite simple as protocols go.

These two early versions of POP were used in the mid-1980s, but not very widely. Again, this is simply because the need for an offline e-mail access protocol was limited at that time; most people were not on the Internet before the 1990s.

In 1988, RFC 1081 was published, describing version 3 of the Post Office Protocol (*POP3*). By this time, the personal computer (PC) was transitioning from a curiosity to a place of importance in the worlds of computing and networking. POP3 was based closely on POP2, but refined and enhanced with the idea of providing a simple and efficient way for PCs and other clients not normally connected to the Internet to access and retrieve e-mail.

Development on POP3 continued through the 1990s, with several new RFCs published every couple of years. RFC 1081 was obsoleted by, in turn, RFCs 1225, 1460, 1725 and 1939. Despite the large number of revisions, the protocol itself has not changed a great deal since 1988; these RFCs contain only relatively minor tweaks to the original description of the protocol. RFC 1939 was published in 1996 and POP3 has not been revised since that time, though a few subsequent RFCs define optional extensions and additions to the basic protocol, such as alternative authentication mechanisms.

While POP3 has been enhanced and refined, its developers have remained true to the basic idea of a very simple protocol for quick and efficient e-mail transfer. POP3 is a straight-forward state-based protocol, with a client and server proceeding through three stages during a session. A very small number of commands are defined to perform simple tasks, and even after all the changes and revisions described above, the protocol has a minimum of “fluff”.

For reasons that are unclear to me, almost everyone refers to the Post Office Protocol with its version number; that is, they say “POP3” instead of “POP”. This is true despite most people not using version numbers with many other protocols, and almost nobody using any other version of POP anyway. But it is the convention, and I will follow it in the rest of this section.



Key Concept: The *Post Office Protocol (POP)* is currently the most popular TCP/IP e-mail access and retrieval protocol. It implements the offline access model, allowing users to retrieve mail from their SMTP server and use it on their local client computers. It is specifically designed to be a very simple protocol and has only small number of commands. The current revision of POP is version 3, and the protocol is usually abbreviated *POP3* for that reason.



Note: There are some implementations of POP that attempt to implement the *disconnected* access model, with limited success. More often, however, IMAP is used for this purpose, since it is better suited to that access model. [See the overview of IMAP for more details.](#)

POP3 General Operation, Client/Server Communication and Session States

As I mentioned in [the previous topic](#), the Post Office Protocol was designed to perform only one main function, and to do it quickly and simply: allow a client computer to access and retrieve e-mail from a server. The operation of the protocol is simple and straight-forward, which is good news for you, the person trying to understand how it works.

Client/Server Communication

POP3 is a regular [TCP/IP client/server protocol](#). To provide access to mailboxes, POP3 server software must be installed and continuously running on the server where the mailboxes are located. This does not necessarily have to be the same physical hardware device that runs the [SMTP](#) server software that receives mail for those boxes—a mechanism such as [NFS](#) may be used to allow the POP3 and SMTP servers to both “see” mailboxes locally. POP3 clients are regular end-user e-mail programs that make connections to POP3 servers to get mail; examples include Microsoft Outlook, Eudora Email and so forth.

POP3 uses the [Transmission Control Protocol \(TCP\)](#) for communication, to ensure the reliable transfer of commands, responses and message data. POP3 servers “listen” on [well-known port number](#) 110 for incoming connection requests from POP3 clients. After a TCP connection is established, the POP3 session is activated. The client sends commands to the server, which replies with responses and/or e-mail message contents.

Commands and Response Codes

POP3 commands are three or four letters long and are case-insensitive. They are all sent in plain ASCII text and terminated with a “CRLF” sequence, just as with [FTP](#) and [SMTP](#) commands. POP3 replies are also textual, but the protocol does *not* use the complex [three-digit reply code mechanism of FTP](#) (and SMTP). In fact, it defines only two basic responses:

- ☉ **+OK:** A positive response, sent when a command or action is successful; and
- ☉ **-ERR:** A negative response, sent to indicate that an error has occurred.

These messages may be accompanied by explanatory text, especially in the case of an *-ERR* response, to provide more information about the nature of the error.

Session States

POP3 is described in terms of a finite state machine (FSM), with a session transitioning through three states during the course of its “lifetime”, as shown in [Figure 306](#).



Note: I describe the concepts behind Finite State Machines in [the topic describing the TCP FSM](#).

Before you get too intimidated, realize that unlike the FSMs of protocols like TCP, this one really is simple, because it is *linear*. The session goes through each state once and only once, in the following sequence:

1. **Authorization State:** The server provides a greeting to the client to indicate that it is ready for commands. The client then provides authentication information to allow access to the user's mailbox.
2. **Transaction State:** The client is allowed to perform various operations on the mailbox. These include listing and retrieving messages, and marking retrieved messages for deletion.
3. **Update State:** When the client is done with all of its tasks and issues the *QUIT* command, the session enters this state automatically, where the server actually deletes the messages marked for deletion in the *Transaction* state. The session is then concluded and the TCP connection between the two terminated.

POP3 is designed so that only certain commands may be sent in each of these states. The next three topics describe the activities that take place in these three states, including the commands that are issued by the client in each.



Key Concept: POP3 is a client/server protocol that is described using a simple linear sequence of states. A POP3 session begins with a POP3 client making a TCP connection to a POP3 server, at which point the session is in the *Authorization* state. After successful authentication, the session moves to the *Transaction* state, where the client can perform mail access transactions. When it is done, the client ends the session and the *Update* state is entered automatically, where cleanup functions are performed and the POP3 session ended.

POP3 Authorization State: User Authentication Process and Commands

A session between a POP3 client and a POP3 server begins when the client sends a TCP connection request to the server. The connection is established using the standard TCP “[three-way handshake](#)”, and the POP3 session commences. The first of the three states of a POP3 session is the *Authorization* state, which is responsible for authenticating the POP3 client with the server.

When the session first enters this state, the server sends a *greeting* message to the client. This tells the client that the connection is alive and ready for the client to send the first command. An example of such a greeting would be:

```
+OK POP3 server ready
```

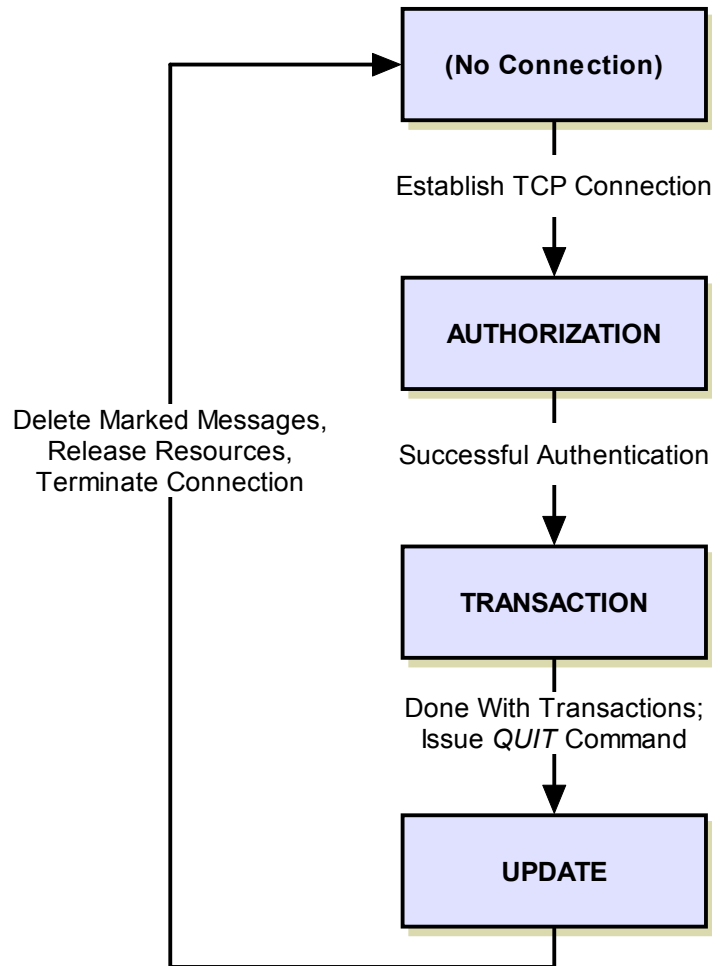

Figure 306: Post Office Protocol (POP3) Finite State Machine

POP uses a finite state machine to describe its operation, but it is very simple because it is linear. Once a TCP connection is established between a POP3 client and POP3 server, the session proceeds through three states in sequence, after which the connection is terminated.

The client is now required to *authenticate* the user who is trying to access a mailbox. This both proves that the user has the right to access the server, and identifies the user so the server knows which mailbox is being requested.

Standard POP3 Authentication

The normal method of authorization in POP3 is a standard “username / password” login. This is pretty much identical to [how a login is performed in FTP](#); even the commands are the same. First the client issues a *USER* command along with the user's mailbox name (his or her user name or e-mail address). The server responds with an intermediate acknowledgment. The client then uses the *PASS* command to send the user's password. Assuming the login is valid, the server responds to the client with an acknowledgment that indicates successful authentication. The response will also typically specify the number of messages waiting for the user in the mailbox. This process is illustrated in [Figure 307](#).

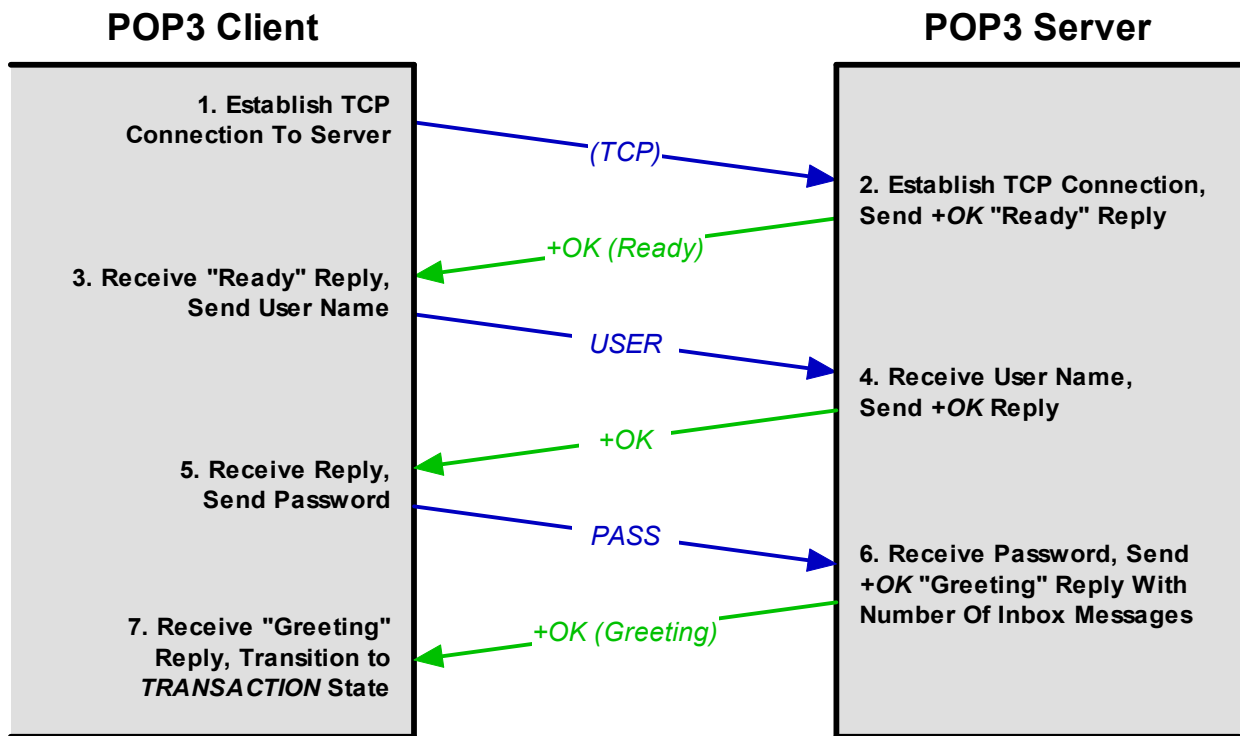

Figure 307: Post Office Protocol (POP3) User Authentication Process

Once the TCP connection is established from the client to the server, the server responds with a greeting message, and the simple POP3 authentication process begins. The client sends a user name and password to the server using the *USER* and *PASS* commands, and the server evaluates the information to determine whether or not it will allow the client access.

Table 257 shows an example POP3 authorization, with the client's commands highlighted and the server's responses in italics.

Table 257: Example POP3 Authorization

```

+OK POP3 server ready
USER jane@somewhereelse.com
+OK
PASS *****
+OK jane@somewhereelse.com has 3 messages

```



Note: Some servers may require only the name of the user ("jane") while others require the full e-mail address as shown in the example. Also, I have not shown Jane's password in Table 257; that wouldn't be very nice, would it? ☺

If authorization is successful, the POP3 session transitions to the *Transaction* state where [mail access commands can be performed](#). If the user name or password are incorrect, an error response is given and the session cannot proceed. The authorization may also fail due to technical problems, such as an inability by the server to lock the mailbox (perhaps due to new mail arriving via SMTP).

Alternative Authentication Using APOP

Since user/password authorization is considered by many people to be insufficient for the security needs of modern internetworks, the POP3 standard also defines an alternative authentication method, using the *APOP* command. This is a more sophisticated technique based on the MD5 “message digest” encryption algorithm.

If the server supports this technique, in its opening greeting it provides a string indicating a *timestamp* that is unique for each POP3 session. The client then performs an MD5 calculation using this timestamp value and a “shared secret” known by the server and client. The result of this calculation is included in the client's *APOP* command. If it matches the server's calculation, authentication is successful; otherwise the session remains in the *Authorization* state.

The Post Office Protocol was also designed to allow it to be extended through the addition of other authentication mechanisms. This process is based on the use of the optional *AUTH* command, as described in RFC 1734.



Key Concept: A POP3 session begins in the *Authorization* state, where the client device is expected to authenticate with the server. By default, POP3 uses only a simple username/password authentication method. Optional authentication methods are also defined for applications requiring more security.

POP3 *Transaction* State: Mail and Information Exchange Process and Commands

Once the POP3 client has successfully authenticated the user who is performing mailbox access, the session transitions from the *Authorization* state to the *Transaction* state. There's no real mystery what this phase of the connection is all about: it is where the POP3 client issues the commands that perform mailbox access and message retrieval transactions.

POP3 Transaction Commands

Most of the commands defined in POP3 are valid only in the *Transaction* state. [Table 258](#) lists each of them, in the order in which they appear in RFC 1939.

Table 258: POP3 Transaction Commands

Command Code	Command	Parameters	Description
STAT	<i>Status</i>	None	Requests status information for the mailbox. The server will normally respond telling the client the number of messages in the mailbox, and the number of bytes of data it contains. Optionally, more information may also be returned.
LIST	<i>List Messages</i>	Optional message number	Lists information for the messages in a mailbox; generally this means showing the message number and its size. If a message number is given, only that message's information is provided; otherwise, the full contents of the mailbox are described, one line at a time, with a line containing just a single period at the end.
RETR	<i>Retrieve</i>	Message number	Retrieves a particular message from the mailbox. The server responds with a standard "+OK" message and then immediately sends the message in RFC 822 format, one line at a time. A line with a period by itself is sent after the last line.
DELE	<i>Delete</i>	Message number	Marks a message as deleted. Once deleted, any further attempt to access a message (using <i>LIST</i> or <i>RETR</i> for example) results in an error.
NOOP	<i>No Operation</i>	None	Does nothing; the server just returns a +OK reply.
RSET	<i>Reset</i>	None	Resets the session to the state it was in upon entry to the <i>Transaction</i> state. This includes "undeleting" any messages already marked for deletion.
TOP	<i>Retrieve Message Top</i>	Message number and number of lines	Allows a client to retrieve only the beginning of a message. The server returns the headers of the message and only the first <i>N</i> lines where <i>N</i> is the number of lines specified. This command is optional and may not be supported by all servers.
UIDL	<i>Unique ID Listing</i>	Optional message number	If a message number was specified, returns a unique identification code for that message; otherwise, returns an identification code for each message in the mailbox. This command is optional and may not be supported by all servers.

Typical POP3 Mail Exchange Sequence

The *Transaction* state is relatively “unstructured” in that commands do not need to be issued in any particular order to meet the requirements of the standard. However, there is a natural progression to how a mailbox is retrieved, and that means the commands are usually used in the following way:

1. The client issues a *STAT* command to see the number of messages in the mailbox.
2. The client issues a *LIST* command and the server tells it the number of each message to be retrieved.
3. The client issues a *RETR* command to get the first message and if successful, marks it for deletion with *DELE*. The client uses *RETR/DELE* for each successive message.

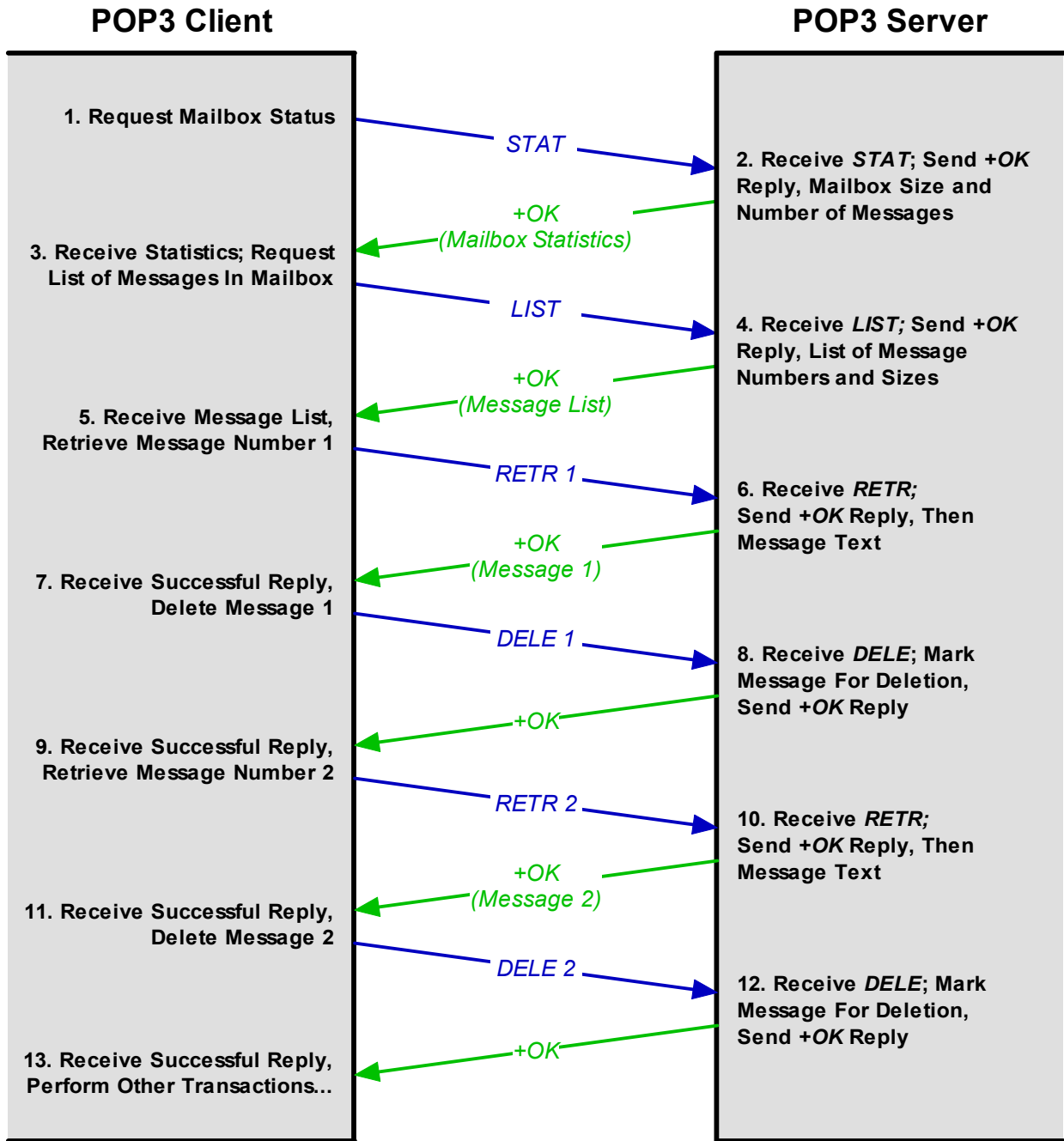

Figure 308: Post Office Protocol (POP3) Mail Exchange Process

This diagram shows the typical exchange of commands and replies employed by a POP3 client to retrieve e-mail from a POP3 server. The *STAT* command is used to get mailbox statistics, followed by the *LIST* command to obtain a list of message numbers. Each message in turn is then retrieved using *RETR* and marked for deletion by *DELE*. (Messages are not actually deleted until the *Update* state is entered.)

Table 259 and Figure 308 show a sample access sequence for a mailbox containing two messages that are a total of 574 bytes; the client's commands are highlighted and the server's responses are in italics.

Table 259: Example POP3 Mail Exchange Process

```
STAT  
+OK 2 574  
LIST  
+OK  
1 414  
2 160  
.  
RETR 1  
+OK  
(Message 1 is sent)  
.  
DELE 1  
+OK message 1 deleted  
RETR 2  
+OK  
(Message 2 is sent)  
.  
DELE 2  
+OK message 2 deleted  
QUIT
```

The exact message sent in reply to each command is server-dependent; some just say “+OK” while others provide more descriptive text as I have done here for the responses to the *DELE* command.

In some cases, a POP3 client may be configured to **not** delete messages after retrieving them. This is useful, for example, when [Web-based access](#) is being combined with a conventional e-mail client program.



Key Concept: After successful authorization, the POP3 session transitions to the *Transaction* state, where the client actually accesses e-mail messages on the server. The client normally begins by first retrieving statistics about the mailbox from the server, and obtaining a list of the messages in the mailbox. The client then retrieving each message one at a time, marking each retrieved message for deletion on the server.

POP3 Update State: Mailbox Update and Session Termination Process and Commands

Once the POP3 client has completed all the e-mail [message access and retrieval transactions](#) that it needed to perform, it is done with the POP3 session—except it isn't really quite done yet. The POP3 standard defines a final session state, the *Update* state, to perform various housekeeping functions, and then terminate both the POP3 session and the underlying TCP connection.

The transition from the *Transaction* state to the *Update* state occurs when the POP3 client issues the *QUIT* command. This command has no parameters, and serves to tell the POP3 server that the client is done and wishes to end the session. The POP3 standard lists this command as part of its description of the *Update* state, though it obviously is really issued from the *Transaction* state.

After the POP3 server receives the *QUIT* command, one thing it does is to delete any messages that were previously marked for deletion by the *DELE* command in the *Transaction* state. It's interesting that the Post Office Protocol chose to implement this two-stage deletion process. The standard doesn't describe specifically why this was done, but it seems likely that it is a precaution to insure against accidental deletion and loss of mail.

By delaying actual deletion until the *Update* state, the server can verify that it has received and processed all commands prior to the move to the *Update* state. It also allows the deletion of messages to be “undone” if necessary, using the *RSET* command, if the user changes his or her mind about the deletion prior to exiting the *Transaction* state. Finally, if any problem occurs with communication between the client and server that causes the TCP connection to be interrupted prematurely before the *QUIT* command is issued, no messages will be removed from the mailbox, giving the client a second chance to retrieve them in case they were not received properly.

Once the deleted messages have been removed, the server returns an acknowledgment to the client; “+OK” if the update was successful, or “-ERR” if there was some sort of a problem removing one or more of the deleted messages. Assuming there were no problems, the “+OK” response will also contain a “goodbye” message of some sort indicating that the session is about to be closed. The TCP connection between the client and server is then torn down and the session is done.

A POP3 mail retrieval session normally lasts a few seconds or minutes, but can take many minutes if the mailbox is large and the connection between the client and server is slow. There is no limit on how long the client and server can be connected, as long as commands continue to be sent by the client. A POP3 server will normally implement an inactivity timer, however, which is customizable but must have a duration of no less than 10 minutes. If the connection is idle for the full duration of the inactivity timer, the server assumes that the client has experienced some sort of a problem and shuts down the connection. If this occurs, the server does *not* delete any messages marked for deletion—again, this is in order to give the client another chance to retrieve those messages if a problem occurred getting them the first time.



Key Concept: When the POP3 client is done with its e-mail transactions, it issues the *QUIT* command. This causes the *Update* state to be automatically entered, where the server performs necessary clean-up operations, including deleting any messages marked for deletion in the *Transaction* state.



TCP/IP Internet Message Access Protocol (IMAP/IMAP4)

The *offline mailbox access model* provides the basic mail access functions that most users need. Using the popular [Post Office Protocol \(POP3\)](#), a user can access his or her mailbox and retrieve messages so they can be read on a local machine. This model has the advantage of simplicity, but does not provide many features that are increasingly in demand today, such as keeping track of the status of messages and allowing access from many client devices simultaneously. To provide better control over how mail is accessed and managed, we must use either the *online* or *disconnected* access models. The *Internet Message Access Protocol (IMAP)* was created to allow these access models to be used, providing rich functionality and flexibility for the TCP/IP e-mail user.

In this section I describe the operation of the Internet Message Access Protocol. I begin as I usually do, with a general look at the protocol, its history, versions and standards. This includes a discussion of its benefits compared to the simpler POP3. I describe the operation of the current version of the standard, IMAP4, focusing on how client and server devices communicate and showing how the IMAP session moves through a series of four states. I describe how IMAP commands, results and responses are used and discuss the commands that can be used at any time during an IMAP session. I then describe the processes that are performed and commands used in each of the three main IMAP states.



Related Information: The main price that IMAP pays for having a much richer set of functionality than POP is much more complexity. In this section, I have described IMAP in approximately the same level of detail that I did POP in its section. Please see the appropriate RFC documents for the full description of the protocol and more discussion of some of its nuances, particularly the syntax of the many commands and parameters, which would take dozens of pages to cover fully here.

IMAP Overview, History, Versions and Standards

The [Post Office Protocol](#) (POP, or POP3 after its current version) has become the most popular protocol for accessing TCP/IP mailboxes not because of its rich functionality, but in spite of its lack of it. POP implements the *offline* mail access model, where mail is retrieved and then deleted from the server where the mailbox resides, so it can be used on a local machine. Millions of people use POP3 every day to access incoming mail. Unfortunately, due to the way the offline access model works, POP3 cannot really be used for much else.

As I said in my [overview of mailbox access models](#), the online model is the one we would use in an “ideal world”, where all of us were always connected to the Internet all the time. Offline access is a necessity because this is not the case; most user client machines are only connected to the Internet periodically. The transfer of mail from the server to a client machine removes the requirement that we be online to perform mail functions, but costs us the benefits of central mail storage on the server.

The Benefits of Centralized E-Mail Storage

You may find it counterintuitive that it could be **better** to have mail stored on some remote server rather than on our local computer. The main reason is flexibility of access. One of the biggest problems with offline access using POP3 is that mail is transferred permanently from a central server to **one** client machine. This is fine so long as an individual only uses that one machine, but what if the person has separate work and home computers, or travels a great deal? How about if a mailbox is shared by many users? These concerns have become more and more important in recent years.

Another issue is data security and safety. Mail servers run by Internet service providers are usually located in professionally-managed data centers. They are carefully controlled and monitored, and backups are done on a routine basis. Most people do not take this sort of care with their own PCs and Macintoshes, nor do they back up their data routinely. It is thus more likely that mail be lost when it is on a local machine than when it remains on the server.

Of course, we still have the problem of not wanting to force users to be online all the time to access their mail. The solution is the *disconnected* mailbox access model, which marries the benefits of online and offline access. Mail is retrieved for local use as in the offline model, so the user does not have to be connected to the server continuously. However, changes made to the mailbox are synchronized between the client and the server. The mail remains on the server where it can be accessed from a different client in the future, and the server acts as a permanent “home base” for the user's mail.

Recognizing these benefits, some attempts were made to implement POP using the disconnected access model. Typically, this was done by using POP commands to retrieve mail but still leave it on the server, which is an option in many client programs. This works, but only to a limited extent; for example, keeping track of which messages are new or old becomes an issue when they are both retrieved and left on the server. POP simply lacks the features required for proper disconnected access, because it was not designed for it.

IMAP Features

In the mid-1980s, development began at Stanford University on a new protocol that would provide a more capable way of accessing user mailboxes. The result was the *Interactive Mail Access Protocol*, later renamed the *Internet Message Access Protocol (IMAP)*. IMAP was designed for the specific purpose of providing flexibility in how users access e-mail messages. It in fact can operate in all three of the access modes: online, offline and disconnected access. Of these, it is the online and disconnected access modes that are of interest to most users of the protocol; offline access is similar to how POP works.

IMAP allows a user to do all of the following:

- ☉ Access and retrieve mail from a remote server so it can be used locally while retaining it on the server.
- ☉ Set message flags so that the user can keep track of which messages he or she has already seen, already answered, and so on.

-
- ☉ Manage multiple mailboxes and transfer messages from one mailbox to another. You can organize mail into categories, which is useful for those working on multiple projects, those who are on various mailing lists and so forth.
 - ☉ Determine information about a message prior to downloading it, to decide whether or not to retrieve it.
 - ☉ Download only portions of a message, such as one body part from a [MIME multipart message](#). This can be quite helpful in cases where large multimedia files are combined with short text elements in a single message.
 - ☉ Manage documents other than e-mail. For example, IMAP can be used to access [Usenet messages](#).

Of course, there are some disadvantages to IMAP, but not many. One is that it is more complex, but it's really not *that* complex, and the protocol has been around for enough years that this is not a big issue. The most important sticking point with IMAP is simply that it is used less commonly than POP, so providers that support it are not as easy to find as those that support POP. This is changing, however, as more people discover IMAP's benefits.



Key Concept: The Post Office Protocol is popular because of its simplicity and long history, but POP has few features and normally only supports the rather limited *offline* mail access method. To provide more flexibility for users in how they access, retrieve and work with e-mail messages, the *Internet Message Access Protocol (IMAP)* was developed. IMAP is primarily used in the online and disconnected access models; it allows users to access mail from many different devices, manage multiple mailboxes, select only certain messages for downloading, and much more. Due to its many capabilities, it is growing in popularity.

IMAP History and Standards

IMAP has had a rather interesting history. I mean “interesting” in the sense that the normal orderly development process that is used for most TCP/IP protocols broke down. The result wasn't quite as bad as [what occurred with SNMP](#), but is still unusual.

The first version of IMAP formally documented as an Internet standard was IMAP version 2 (IMAP2) in RFC 1064, published July 1988. This was updated in RFC 1176, August 1990, retaining the same version number. However, it seems that some of the people involved with IMAP were not pleased with RFC 1176, so they created a new document defining version 3 of IMAP (IMAP3): RFC 1203, published in February 1991. This is described by its authors as a “counter proposal”.

For whatever reason, however, IMAP3 was never accepted by the marketplace. Instead, people kept using IMAP2 for a while. An extension to the protocol was later created, called *IMAP2bis*, which added support for [MIME](#) to IMAP. This was an important development due

to the usefulness of MIME, and many implementations of IMAP2bis were created. Despite this, for some reason IMAP2bis was never published as an RFC. This may have been due to the problems associated with the publishing of IMAP3.



Note: “bis” is a Latin word meaning “again”. It is sometimes used to differentiate changed technical documents from their previous versions when no “official” new version number is allocated.

In December 1994, IMAP version 4 (IMAP4) was published in two RFCs: RFC 1730 describing the main protocol, and RFC 1731 describing authentication mechanisms for IMAP4. IMAP4 is the current version of IMAP and the one widely used today. It continues to be refined; the latest specific version is actually called version *4rev1 (IMAP4rev1)*, defined in RFC 2060 and then most recently by RFC 3501. Most people still just call this “IMAP4” and that’s what I will do in the rest of this section.

IMAP General Operation, Client/Server Communication and Session States

IMAP does the same basic job as [POP](#): it enables access to a mailbox stored on a remote server. For this reason, it’s not too surprising that IMAP is somewhat similar to POP in operation, and you’ll notice those similarities in this topic if you’ve already read about POP3. However, IMAP has many more features and capabilities than POP. Therefore, it’s also not too surprising that IMAP would be more complex than POP in terms of how it operates, and I think you will notice this as well.

Client/Server Communication

IMAP4 is a standard client/server protocol like POP3 and [most other TCP/IP application protocols](#). For the protocol to function, an IMAP4 server must be operating on the server where user mailboxes are located. Again, as with POP3, this need not necessarily be the same physical server as the one that provides SMTP service. The mailbox must in some way be made accessible to both SMTP for incoming mail and to IMAP4 for message retrieval and modification. A mechanism for ensuring exclusive access to avoid interference between the various protocols is also needed.

IMAP4 uses the [Transmission Control Protocol \(TCP\)](#) for communication. This ensures that all commands and data are sent reliably and received in the correct order. IMAP4 servers listen on [well-known port number](#) 143 for incoming connection requests from IMAP4 clients. After a TCP connection is established, the IMAP4 session begins.

Session States

The session between an IMAP4 client and server is described in the IMAP standards using a finite state machine (FSM), a descriptive tool that I explain in [the TCP operational overview](#). Again, this is similar to [how the operation of POP3 is explained](#), except that IMAP4 is a bit more complex. Its FSM defines four states instead of three, and where a

POP3 session is linear (only going through each state once) in IMAP4 the session is not. However, the state flow is still fairly straight-forward, mostly following a logical sequence from one state to the next. The IMAP FSM is illustrated in [Figure 309](#).

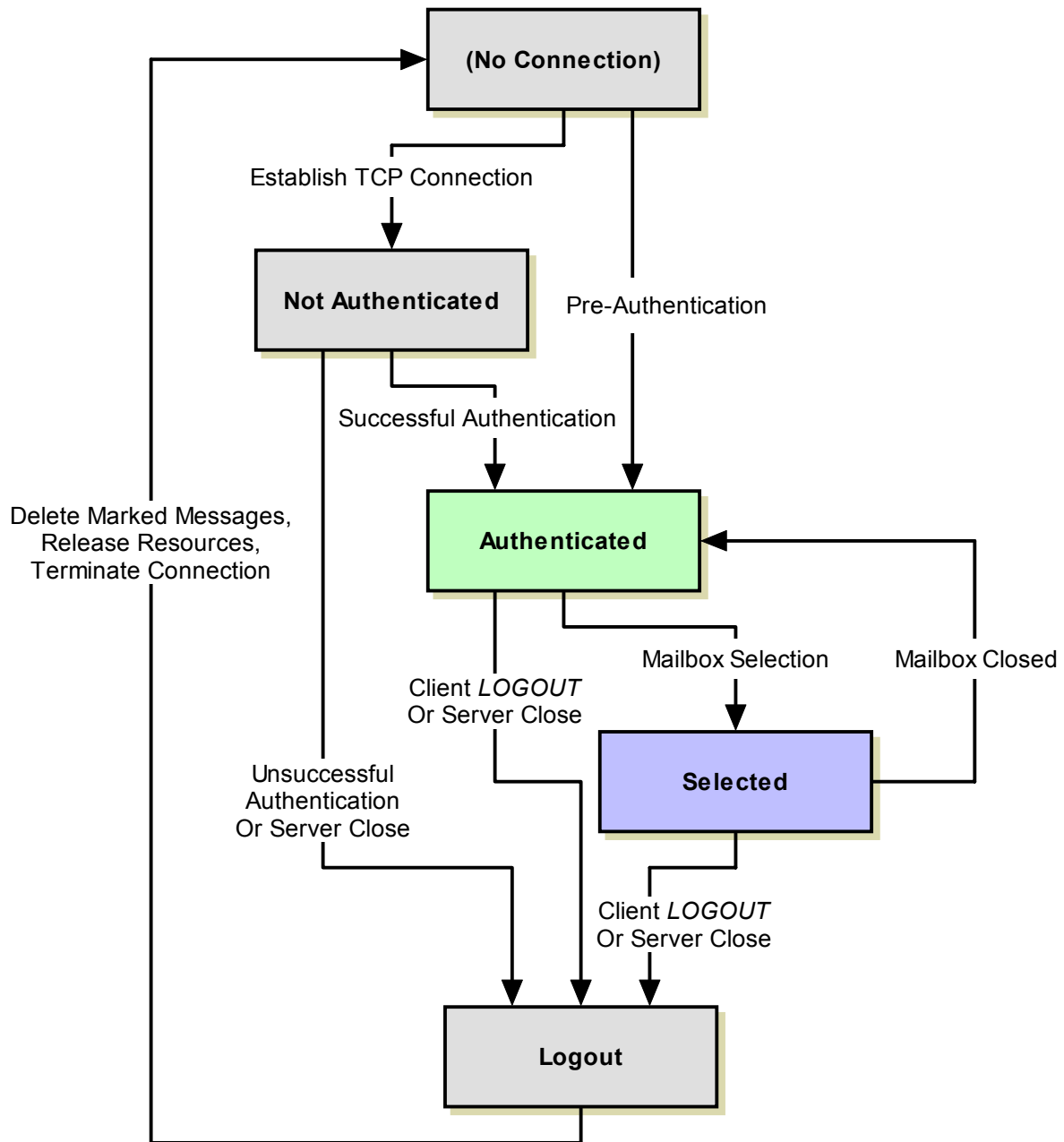

Figure 309: Internet Message Access Protocol (IMAP) Finite State Machine

The IMAP finite state machine is slightly more complex than that of POP ([Figure 306](#)) but still rather straight-forward. Once the TCP connection is made between client and server, the *Not Authenticated* state is entered; after successful authorization, the session moves to the *Authenticated* state. The session may move between *Authenticated* and *Selected* several times, as different mailboxes are selected for use and then closed when no longer needed. From any state the session may be terminated, entering the *Logout* state.

The following are the IMAP states, in the usual sequence in which they occur for a session:

-
1. **Not Authenticated State:** The session normally begins in this state after a TCP connection is established, unless the special IMAP *preauthentication* feature has been used (we'll get to this feature shortly). The client at this point cannot really do much aside from providing authentication information so it can move to the next state.
 2. **Authenticated State:** The client has completed authentication, either through an authentication process in the prior state or through preauthentication. The client is now allowed to perform operations on whole mailboxes. The client must select a mailbox before individual message operations are permitted.
 3. **Selected State:** After a mailbox has been chosen, the client is allowed to access and manipulate individual messages within the mailbox. When the client is done with the current mailbox it can close it and return to the *Authenticated* state to select a new one to work with, or can log out to end the session.
 4. **Logout State:** The client may issue a *Logout* command from any of the other states to request that the IMAP session be ended. The session may also enter this state if the session inactivity timer expires. The server sends a response and the connection is terminated.

Of the four IMAP states, only the first three are “interactive”, meaning states where commands are actively issued by the client and responses provided by the server. Some IMAP commands can be used while the session is in any state, while others are state-specific. [The next topic](#) describes IMAP commands and responses in general terms.



Key Concept: IMAP is a client/server application, and an IMAP session begins with the client making a TCP connection to the server. The session then normally starts in the *Not Authenticated* state and remains there until successful authentication. In the *Authenticated* state, the client may perform operations on whole mailboxes, but a mailbox must be *selected* to transition to the *Selected* state where individual messages can be manipulated. The client can work with many mailboxes by selecting each one in turn; it then logs out from the server.

Normal Session Establishment and Greeting

The server determines in which state the IMAP session begins, and sends a *greeting* message to tell the client the session is established and indicate which state it is in. Normally, the server will begin the session in the *Not Authenticated* state. This is conveyed to the client with the normal *OK* greeting message, such as this:

* OK <server-name> server ready

Preauthentication

In certain circumstances, a server may already know the identity of the client, perhaps as a result of some external authentication mechanism not part of the IMAP protocol. In this case, a special greeting is used:

* PREAUTH <server-name> server ready, logged in as <user-name>

This tells the client that it is already in the *Authenticated* state.

If the server decides for whatever reason not to accept a new session from the client, it can respond with a *BYE* response instead of *OK* or *PREAUTH*, and close the TCP connection.

IMAP Commands, Results and Responses

Once an IMAP session is established, all communication between the client and server takes place in the form of *commands* sent by the client and *responses* returned by the server. Like POP3, commands and responses are sent as strings of ASCII text and terminated with a “CRLF” sequence, making them compatible with the way data is sent using the [Telnet Protocol](#). However, IMAP does a few things quite differently than POP and many other TCP/IP application protocols.

The first interesting thing about IMAP commands is that most are not abbreviated into codes of three or four letters—they are spelled out in full. So, where POP3 has a *STAT* command, the one in IMAP is called *STATUS*. Commands are normally shown in upper case, as I do in this Guide, but are in fact case-insensitive.

Command Tagging and the Multiple Command Feature

IMAP also uses an interesting system of *command tagging* to explicitly match client commands with certain server responses. Each time a client sends a command, it prefixes it with a tag that is unique for the particular session. The tags are usually short strings with a monotonically increasing number in them; the examples in the IMAP standards have the first command tagged “a0001”, then the second “a0002” and so on. That said, as long as each command is uniquely labelled, it doesn't matter what tagging scheme is used. When the server needs to send a response that is specific to a command, it tags the reply with the appropriate command tag. Not all replies are tagged, however.

The standard doesn't state explicitly why this tagging scheme is needed, but I believe it is probably related to IMAP's *multiple command* feature. IMAP clients are allowed to send a sequence of commands to the server to be processed, rather than only sending commands one at a time. This can improve performance when certain commands would take a long time to complete. The only restriction is that the commands must be independent enough that the result of executing them all would be the same regardless of the order in which they were processed. For example, sending a command to read a particular entity in combination with a command to store a value into the same entity is not allowed.



Key Concept: IMAP tags its commands with a unique identifier. These tags can then be used in replies by the server to match replies with the commands to which they correspond. This enables multiple commands to be sent to an IMAP server in succession.

Command Groups

IMAP commands are organized into groups based on which [session states](#) the IMAP session may be in when they are used. These groups are:

- ☉ **“Any State” Commands:** A small number of commands that can be used at any time during an IMAP session.
- ☉ **Not Authenticated State Commands:** Commands that can be used only in the *Not Authenticated* state. They are usually used for authentication, of course.
- ☉ **Authenticated State Commands:** These commands are used to perform various actions on mailboxes. (Note that despite the name, these commands can also be used in the *Selected* state.)
- ☉ **Selected State:** A set of commands for accessing and manipulating individual messages that can be used only in the *Selected* state.

The reason for having the distinct *Authenticated* and *Selected* states and command groups is that IMAP is designed specifically to enable the manipulation of multiple mailboxes. After the session starts and the client is authenticated, the client is allowed to issue commands that work with entire mailboxes. However, it may not issue commands that manipulate individual messages until it tells the server which mailbox it wants to work with, which puts it in the *Selected* state. The client can also issue mailbox commands from the *Selected* state.



Note: In addition to these four groups, the standard also defines an *extension mechanism* that allows new commands to be defined. These must begin with the letter “X”.

“Any State” Commands

[Table 260](#) describes the IMAP “any state” commands, which can be used whenever needed.

Table 260: IMAP “Any State” Commands (Page 1 of 2)

Command	Parameters	Description
<i>CAPABILITY</i>	None	Asks the server to tell the client what capabilities and features it supports.

Table 260: IMAP “Any State” Commands (Page 2 of 2)

Command	Parameters	Description
NOOP (No Operation)	None	Does nothing. This may be used to reset the inactivity timer or to periodically prompt the server to send notification if new messages arrive.
LOGOUT	None	Tells the server that the client is done and ready to end the session, which transitions to the Logout state for termination.

Results and Responses

Each command sent by the IMAP client elicits some sort of reaction from the IMAP server, of course. The server takes action based on what the client requested, and then returns back one or more text strings to indicate what occurred. There are actually two types of replies that the server can send after a command is received:

- ☉ **Result:** This is a reply usually indicating the status or disposition of a command. It may be tagged with the command tag of the command whose result it is communicating, or may be a general message that is not tagged.
- ☉ **Response:** Any type of information that is being sent by the server to the client. It is usually not tagged with a command tag and is not specifically intended to indicate server status.



Note: The IMAP standards sometimes use the terms “result”, “response” and “reply” in a manner that I find to be inconsistent. Watch out for this if you examine the IMAP RFCs.



Key Concept: IMAP servers issue two basic types of replies to client commands. *Results* are replies that indicate the success, failure or status of a command; *responses* are general replies containing many different types of information that the server needs to send to the client.

Result Codes

There are three main result codes sent in reply to a command, and two special ones used in certain circumstances:

- ☉ **OK:** A positive result to a command, usually sent with the tag of the command that was successful. May be sent untagged in the server's initial greeting when a session starts.
- ☉ **NO:** A negative result to a command. When tagged, indicates the command failed; when untagged, serves as a general warning message about some situation on the server.

-
- ☉ **BAD:** Indicates an error message. It is tagged when the error is directly related to a command that has been sent, and otherwise is untagged.
 - ☉ **PREAUTH:** An untagged message sent at the start of a session to indicate that no authentication is required; the session goes directly to the *Authenticated* state.
 - ☉ **BYE:** Sent when the server is about to close the connection. It is always untagged, and is sent in reply to a *Logout* command or when the connection is to be closed for any other reason.

Response Codes

In contrast to results, responses are used to communicate a wide variety of information to the client device. Responses normally include descriptive text that provides details about what is being communicated. They may be sent either directly in reply to a command or incidentally to one. An example of the latter case would be if a new message arrives in a mailbox during a session. In this case, the server will convey this information “unilaterally” at its first opportunity, regardless of what command was recently sent.

The following are the response codes defined by the IMAP standard:

- ☉ **ALERT:** An alert message to be sent to the human user of the IMAP client to inform him or her of something important.
- ☉ **BADCHARSET:** Sent when a search fails due to use of an unsupported character set.
- ☉ **CAPABILITY:** A list of server capabilities; may be sent as part of the initial server greeting so the *CAPABILITY* command does not need to be used.
- ☉ **PARSE:** Sent when an error occurs parsing the headers or MIME content of an e-mail message.
- ☉ **PERMANENTFLAGS:** Communicates a list of message status flags that the client is allowed to manipulate.
- ☉ **READ-ONLY:** Tells the client that the mailbox is only accessible in a read-only mode.
- ☉ **READ-WRITE:** Tells the client that the mailbox is accessible in read-write mode.
- ☉ **TRYCREATE:** Sent when an *APPEND* or *COPY* command fails due to the target mailbox not existing, to suggest to the client that it try creating the mailbox first.
- ☉ **UIDNEXT:** Sent with a decimal number that specifies the next unique identifier value to use in an operation. These identifiers allow each message to be uniquely identified.
- ☉ **UIDVALIDITY:** Sent with a decimal number that specifies the unique identifier validity value, used to confirm unique message identification.
- ☉ **UNSEEN:** Sent with a decimal number that tells the client the message that is flagged as not yet seen (a new message).

IMAP Not Authenticated State: User Authentication Process and Commands

An IMAP4 session begins with an IMAP4 client establishing a TCP connection with an IMAP4 server. Under normal circumstances, the IMAP4 server has no idea who the client is, and therefore starts the session in the *Not Authenticated* state. For security reasons, the

client is not allowed to do anything until it is authenticated. Thus, the only purpose of this state is to allow the client to present valid credentials so the session can move on to the *Authenticated* state.

IMAP Not Authenticated State Commands

The IMAP4 standard defines three different mechanisms by which a client may authenticate itself. These are implemented using one or more of the three different commands allowed only in the *Not Authenticated* state, which are shown in [Table 261](#).

Table 261: IMAP Not Authenticated State Commands

Command	Parameters	Description
LOGIN	User name and password	Specifies a user name and password to use for authentication.
AUTHENTICATE	Authentication mechanism name	Tells the server that the client wants to use a particular authentication mechanism and prompts the client and server to exchange authentication information appropriate for that mechanism.
STARTTLS	None	Tells the IMAP4 server to use the Transport Layer Security (TLS) protocol for authentication, and prompts TLS negotiation to begin.

IMAP Authentication Methods

The authentication methods are:

1. **Plain Login:** This is the typical “username / password” technique, using the *LOGIN* command by itself. This is similar to [the simple scheme used in POP3](#), except that in IMAP4 one command is used to send both the user name and password. Since the command and parameters are sent in plain text, this is by far the least secure method of authentication and is not recommended by the standard unless some other means is used in conjunction.
2. **TLS Login:** This is a secure login where the Transport Layer Security (TLS) protocol is first enabled with the *STARTTLS* command, and then the *LOGIN* command can be used securely. Note that *STARTTLS* only causes the TLS negotiation to begin, and does not itself cause the IMAP client to be authenticated. Either *LOGIN* or *AUTHENTICATE* must still be used.
3. **Negotiated Authentication Method:** The *AUTHENTICATE* command allows the client and server to use any authentication scheme that they both support. The server may indicate which schemes it supports in response to a *CAPABILITY* command. After specifying the authentication mechanism to be used, the server and client exchange authentication information as required by the mechanism specified. This may require one or more additional lines of data to be sent.

In response to a *LOGIN* or *AUTHENTICATE* command, the server will send an “OK” message if the authentication was successful, and then transition to the *Authenticated* state. It will send a “NO” response if authentication failed due to incorrect information. The client can then try another method of authenticating, or terminate the session with the *LOGOUT* command.



Key Concept: IMAP supports three basic types of authentication: a plain username/password login; authentication using Transport Layer Security; or the negotiation of some other authentication method between the client and server. In some cases, the IMAP server may choose to *preauthenticate* clients that it is able to reliably identify, in which case the *Not Authenticated* state is skipped entirely.

IMAP Authenticated State: Mailbox Manipulation/Selection Process and Commands

In the normal progression of an IMAP session, the *Authenticated* state is the first one where the IMAP client is able to perform “useful work” on behalf of its user. This state will normally be reached from the *Not Authenticated* state after successful authentication using the *LOGIN* or *AUTHENTICATE* command. Alternately, a server may *preauthenticate* a client and begin the session in this state directly.

Once in the *Authenticated* state, the client is considered authorized to issue commands to the server. However, it may only give commands that deal with *whole mailboxes*. As mentioned in the [general operation overview](#), IMAP was created to allow access to, and manipulation of, multiple mailboxes. For this reason, the client must specify dynamically which mailbox it wants to use before commands dealing with individual messages may be given. This is done in this state using the *SELECT* or *EXAMINE* commands, which cause a transition to the *Selected* state as we will see.

It is also possible that the *Authenticated* state can be re-entered during the course of a session. If the *CLOSE* command is used from the *Selected* state to close a particular mailbox, the server will consider that mailbox “de-selected” and the session will transition back to the *Authenticated* state until a new selection is made. The same can occur if a new *SELECT* or *EXAMINE* command is given from the *Selected* state but fails.

Authenticated State Commands

[Table 262](#) provides a brief description of the mailbox-manipulation commands that can be used in the *Authenticated* state:

Table 262: IMAP Authenticated State Commands (Page 1 of 2)

Command	Parameters	Description
<i>SELECT</i>	Mailbox name	Selects a particular mailbox so that messages within it can be accessed. If the command is successful, the session transitions to the <i>Selected</i> state. The server will also normally respond with information for the client about the selected mailbox; see below.
<i>EXAMINE</i>	Mailbox name	Exactly the same as the <i>SELECT</i> command, except that the mailbox is opened “read-only”; no changes are allowed to it.
<i>CREATE</i>	Mailbox name	Creates a mailbox with the given name.
<i>DELETE</i>	Mailbox name	Deletes the specified mailbox.

Table 262: IMAP Authenticated State Commands (Page 2 of 2)

Command	Parameters	Description
RENAME	Current and new mailbox names	Renames a mailbox.
SUBSCRIBE	Mailbox name	Adds the mailbox to the server's set of "active" mailboxes. This is sometimes used when IMAP4 is employed for Usenet message access.
UNSUBSCRIBE	Mailbox name	Removes the mailbox from the "active" list.
LIST	Mailbox name or reference string	Requests a partial list of available mailbox names, based on the parameter provided.
LSUB	Mailbox name or reference string	The same as <i>LIST</i> but only returns names from the "active" list.
STATUS	Mailbox name	Requests the status of the specified mailbox. The server responds providing information such as the number of messages in the box and the number of recently-arrived and unseen messages.
APPEND	Mailbox name, message, optional flags and date/time	Adds a message to a mailbox.



Note: All of the commands above may also be used in the *Selected* state; they should really be called "*Authenticated+Selected*" state.commands.

The *SELECT* and *EXAMINE* Commands

When either the *SELECT* or *EXAMINE* command is successfully issued, the server will return to the client a set of useful information about the mailbox, which can be used to guide commands issued from the *Selected* state. This information includes the following three mandatory responses:

- ☉ **<n> EXISTS:** Tells the client the number of messages in the mailbox.
- ☉ **<n> RECENT:** Tells the client the number of recently-arrived (new) messages.
- ☉ **FLAGS (<flag-list>):** Tells the client which flags are supported in the mailbox. These include the following: "\Seen", "\Answered", "\Flagged" (marked for special attention), "\Deleted", "\Draft" and "\Recent". (The backslashes are part of the flag names.)

The reply from the server may also contain these optional replies:

- ☉ **UNSEEN <n>:** The message number of the first unseen message.
- ☉ **PERMANENTFLAGS (<flag-list>):** A list of flags (as for the *FLAGS* response above) that the client is allowed to change.
- ☉ **UIDNEXT <n>:** The next unique identifier value. This is used to check for changes made to the mailbox since the client last accessed it.

-
- ☉ **UIDVALIDITY <n>**: The unique identifier validity value, used to confirm valid UID values.



Key Concept: In the *Authenticated* state, the IMAP client can perform operations on whole mailboxes, such as creating, renaming or deleting mailboxes, or listing mailbox contents. The *SELECT* and *EXAMINE* commands are used to tell the IMAP server which mailbox the client wants to open for message-specific access. Successful execution of either command causes the server to provide the client with several pieces of important information about the mailbox, after which the session transitions to the *Selected* state.

IMAP *Selected* State: Message Manipulation Process and Commands

Once the IMAP client has been authorized to access the server, it enters the *Authenticated* state, where it is allowed to execute tasks on whole mailboxes. Since IMAP allows multiple mailboxes to be manipulated, message-specific commands cannot be used until the client tells the server what mailbox it wants to work with. Only one mailbox can be accessed at a time in a given session.

After the *SELECT* or *EXAMINE* command is successfully issued, the session enters the *Selected* state. In this state, the full “palette” of message and mailbox commands is available to the client. This includes the message-specific commands below as well as the mailbox commands defined for the *Authenticated* state. Most of IMAP's message-specific commands do not include a mailbox name as a parameter, since the server knows automatically that the commands apply to whatever mailbox was selected in the *Authenticated* state.

The session remains in the *Selected* state for as long as the client continues to have work to do with the particular selected (or “examined”) mailbox. Three different actions can cause a transition out of the *Selected* state:

- ☉ If the client has nothing more to do when it is done with the current mailbox, it can use the *LOGOUT* command to end the session.
- ☉ The client can use the *CLOSE* command to tell the server it is done with the current mailbox but keep the session active. The server will close the mailbox and the session will go back to the *Authenticated* state.
- ☉ The client can issue a new *SELECT* or *EXAMINE* command. This will implicitly close the current mailbox and then open the new one. The transition in this case is from the *Selected* state back to the *Selected* state, but with a new current mailbox.

Selected State Commands

Table 263 lists the message-specific commands that can only be used in the *Selected* state.

Table 263: IMAP Selected State Commands

Command	Parameters	Description
CHECK	None	Sets a “checkpoint” for the current mailbox. This is used to mark when a certain sequence of operations has been completed.
CLOSE	None	Explicitly closes the current mailbox and returns the session to the <i>Authenticated</i> state. When this command is issued, the server will also implicitly perform an <i>EXPUNGE</i> operation on the mailbox.
EXPUNGE	None	Permanently removes any messages that were flagged for deletion by the client. This is done automatically when a mailbox is closed.
SEARCH	Search criteria and an optional character set specification	Searches the current mailbox for messages matching the specified search criteria. The server response lists the message numbers meeting the criteria. See below.
FETCH	Sequence of message numbers and a list of message data items (or a macro)	Retrieves information about a message or set of messages from the current mailbox. See below for more details.
STORE	Sequence of message numbers, message data item name and value	Stores a value for a particular message data item for a set of messages. See below for more details.
COPY	Sequence of message numbers and a mailbox name	Copies the set of messages specified to the end of the specified mailbox.
UID	Command name and arguments	Used to allow one of the other commands above to be performed using unique identifier numbers for specifying the messages to be operated on, rather than the usual message sequence numbers.

The *FETCH* and *STORE* Commands

This command list might seem surprisingly short; you might wonder, for example, where the specific commands are to read a message header or body, delete a message, mark a message as “seen” and so forth. The answer is that these (and much more) are all implemented as part of the powerful and flexible *FETCH* and *STORE* commands.

The *FETCH* command can be used to read a number of specific elements from either one message or a sequence of messages. The list of “message data items” specifies what information is to be read. The data items that can be read include the headers of the message, the message body, flags that are set for the message, the date of the message and much

more. The *FETCH* command can even be used to retrieve *part* of a message, such as one body part of a [MIME multipart message](#), making it very useful indeed. Special “macros” are also defined for convenience. For example, the client can specify the message data item “FULL” to get all the data associated with a message.

The compliment to *FETCH*, *STORE*, is used to make changes to a message. However, this command is not used to modify the basic message information such as the content of headers and the message body. Rather, it exists for changing the message's *status flags*. For example, after replying to a particular message, the client may set the “\Answered” flag for that message using the *STORE* command.

Message deletion in IMAP is done in two stages for safety, as in POP and many other protocols. The client sets the “\Deleted” flag for whichever messages are to be removed, using the *STORE* command. The messages are only really deleted when the mailbox is expunged, typically when it is closed.

The search facility in IMAP4 is also surprisingly quite sophisticated, allowing the client to look for messages based on multiple criteria simultaneously. For example, with the appropriate syntax, you could search for “all posts that are flagged as having been answered, that were sent by Jane Jones before April 1, 2004”. Users of IMAP clients can thus easily locate specific messages even in very large mailboxes, without having to download hundreds of messages to hunt through.



Key Concept: After the client opens a specific mailbox, the IMAP session enters the *Selected* state, where operations such as reading and copying individual e-mail messages may be performed. The two most important commands used in this state are *FETCH*, which can be used to retrieve a whole message, part of a message, or only certain message headers or flags; and *STORE*, which sets a message's status information. IMAP also includes a powerful *search* facility, providing users with great flexibility in finding messages in a mailbox. When the client is done working with a particular mailbox, it may choose a different one and re-enter the *Selected* state, close the mailbox and return to the *Authenticated* state, or log out, automatically entering the *Logout* state.



Other TCP/IP Electronic Mail Access and Retrieval Methods

The [Post Office Protocol \(POP3\)](#) and [Internet Message Access Protocol \(IMAP4\)](#) are the two most common protocols employed for TCP/IP e-mail access and retrieval. The majority of people using e-mail today choose the simplicity and universal acceptance of POP3, while a growing number opt for the power and flexibility of IMAP4. There are, however, some that choose “alternative” ways of accessing e-mail, two of which I feel are worth a closer look.

Both of the methods described in this section are based on the “online” [e-mail access model](#), but they are a study in contrasts in terms of their role in the e-mail system and how they are used. The first is what I call *direct server access*, and describes several ways that mailboxes are accessed without the use of special remote access protocols like POP and IMAP. The second is e-mail access using a World Wide Web browser. This is the newest e-mail access method, and is growing in popularity every year.

TCP/IP Direct Server Electronic Mail Access

In my [overview discussion of e-mail message communication](#), I discussed the different devices involved in a complete mail exchange, and how a message is created and then transported from the originator to the recipient. SMTP is used to carry the message most of the way, to the recipient's mailbox. The last step of the process is to convey the message from the server where the mailbox is located to the machine the client is using.

This final portion of the e-mail journey is usually the job of an e-mail access and retrieval protocol like [POP3](#) or [IMAP4](#). These are *customized* protocols, by which I mean that they were created specifically for the last step of the e-mail communication process. However, there are also several *generic* methods by which an e-mail client can gain access to a mailbox, without the use of a special protocol at all.

E-Mail Direct Access Methods

These methods are all variations of the *online e-mail access model*. They generally work by establishing *direct access* to the server where the mailbox is located. The mailbox itself is just a file on a server somewhere, so if that file can be made available, it can be viewed and manipulated like any other file using an e-mail client program that reads and writes the mailbox file. The following are some of the ways in which this can be done:

- ☉ **Using The SMTP Server Directly:** Obviously, the simplest method for gaining access to the mailbox is to simply log on to the server itself. This is not an option for most people, and even in years gone by it was not often done, for security reasons as well as others. However, even today there are some people who do run their own SMTP servers, giving them considerable control over access to their e-mail.
- ☉ **File Sharing Access:** Using a protocol such as the [Network File System](#), it is possible to have a mailbox mounted on a user's client machine where it can be accessed as if it were a local file. The mail is still on the server and not the client machine, but the communication between the client and the server occurs “transparently” to both the user and the e-mail client software.

-
- ☉ **Dial-Up Remote Server Access:** A user on a client machine dials up a server where his or her mailbox is located and logs in to it. The user then can issue commands to access mail on that server as if he or she were logged in to it directly.
 - ☉ **Telnet Remote Server Access:** Instead of dialing in to the server, a user can connect to it for remote access using the [Telnet Protocol](#).

Pros and Cons of Direct Server E-Mail Access

These techniques are much more commonly associated with timesharing systems, which commonly use the UNIX family of operating systems than others. They are also often combined; for example, remote access is often provided for UNIX users, but most companies don't want users logging in directly to the SMTP server. Instead, an Internet service provider might run an SMTP server on one machine called "mail.companyname.com" and also operate a different server that is designed for client access called "users.companyname.com". A user could access e-mail by dialing into the "users" machine, which would employ NFS to access user mailboxes on the "mail" machine.

Direct server access is a method that has been around for decades. At one time, this was how the majority of people accessed e-mail, for two main reasons. First, if you go back far enough, protocols like POP or IMAP had not yet been developed; the TCP/IP e-mail system as a whole predates them by many years and direct access was the only option back then. Second, the general way that e-mail and networks were used years ago was just different than it is today. Most individuals did not have PCs at home, and there was no Internet as we know it. Remotely accessing a UNIX server using a modem or Telnet for e-mail and other services was just "the way it was done".

I myself got started using direct server access for e-mail over 10 years ago, and still use this today. I Telnet in to a client machine and use a UNIX e-mail program called *elm* to access and manipulate my mailbox. To me, this provides numerous advantages. First and most importantly, I can access my e-mail using Telnet from any machine on the Internet, anywhere around the world. Second, since I am logged in directly, I get immediate notification when new mail arrives, without having to routinely check for new mail. Third, my mailbox is always accessible and all my mail is always on a secure server in a professionally-managed data center. Fourth, I have complete control over my mailbox and can edit it, split it into folders, write custom "spam" filters, or do anything else I need to do.

This probably sounds good, but most people today do not use direct server access because of the disadvantages of this method. One big issue is that you must be logged in to the Internet to access your e-mail. Another one, perhaps even larger, is the need to be familiar with UNIX and a UNIX e-mail program. UNIX is simply not as "user-friendly" as a graphical operating systems such as Windows or the Apple Macintosh. For example, my UNIX e-mail program doesn't support color and cannot show me attached graphic images. I must extract images and other files from [MIME messages](#) and transfer them to my own PC for viewing.

Most people today don't know UNIX and don't want to know it. They are much happier using a fancy graphical e-mail program based on POP3 or IMAP4. However, there are still a number of us old UNIX dinosaurs around who feel the benefits of direct access outweigh the drawbacks. Oh, one other benefit that I forgot to mention is that it's very hard to get a virus in e-mail when you use UNIX.



Key Concept: Instead of using a dedicated protocol like POP3 or IMAP4 to retrieve mail, on some systems it is possible for a user to have *direct server access* to e-mail. This is most commonly done on UNIX systems, where protocols like Telnet or NFS can give a user shared access to mailboxes on a server. This is the oldest method of e-mail access; it provides the user with the most control over his or her mailbox, and is well-suited to those who must access mail from many locations. The main drawback is that it means the user must be on the Internet to read e-mail, and it also usually requires familiarity with the UNIX operating system, which few people use today.

TCP/IP World Wide Web Electronic Mail Access

I don't know about you, but I was pretty darned glad when bell bottoms went out of style... and then, rather mortified when they came **back** in style a few years ago! That's the way the world of fashion is, I suppose. And sometimes, even in networking, "what's old is new again". In this case, I am referring to the use of the online TCP/IP e-mail access model.

Most e-mail users like the advantages of online access, especially the ability to read mail from a variety of different machines. What they don't care for is [direct server access](#) using protocols like [Telnet](#) ("Tel-what?"), UNIX ("my father used to use that I think..." ☺) and non-intuitive, character-based e-mail programs. They want online access but they want it to be simple and easy to use.

In the 1990s, the [World Wide Web](#) was developed and grew in popularity very rapidly, due in large part to its ease of use. Millions of people became accustomed to firing up a Web browser to perform a variety of different tasks, to the point where using the Web became almost "second nature". It didn't take very long before someone figured out that using the Web would be a natural way of providing easy access to e-mail on a server. This is now sometimes called *Webmail*.

How Web-Based E-Mail Works

This technique is straight-forward: it exploits the flexibility of the [Hypertext Transfer Protocol \(HTTP\)](#) to informally "tunnel" e-mail from a mailbox server to the client. A Web browser (client) is opened and given a URL for a special Web server document that accesses the user's mailbox. The Web server reads information from the mailbox and sends it to the Web browser, where it is displayed to the user.

This method uses the [online access model](#) like direct server access, because requests must be sent to the Web server, and this requires the user to be online. The mail also remains on the server as when [NFS](#) or Telnet are used.

Pros and Cons of Web-Based E-Mail Access

The big difference between Web-based mail and the UNIX methods is that the former is much easier for non-experts to use. Since the idea was first developed, many companies have jumped on the Web-mail bandwagon, and the number of people using this technique has exploded into the millions in just a few years. Many free services even popped up in the late 1990s as part of the “dot com bubble”, allowing any Internet user to send and receive e-mail using the Web at no charge (except perhaps for tolerating advertising). Many Internet Service Providers (ISPs) now offer Web access as an option in addition to conventional POP/IMAP access, which is useful for those who travel. Google’s new Gmail service is the latest entrant into the sweepstakes, offering users 1 GB of e-mail storage in exchange for viewing Google’s text ads on their site.

There are drawbacks to the technique, however, which as you might imagine are directly related to its advantages. Web-based mail is easy to use, but inflexible; the user does not have direct access to his or her mailbox, and can only use whatever features the provider’s Web site implements. For example, suppose the user wants to search for a particular string in his or her mailbox; this requires that the Web interface provide this function. If it doesn’t, the user is out of luck.

Web-based mail also has a disadvantage that is an issue for some people: performance. Using conventional UNIX direct access, it is easy to quickly read through a mailbox; the same is true of access using POP3, once the mail is downloaded. In contrast, Web-based mail services mean each request requires another HTTP request/response cycle. The fact that many Web-based services are free often means server overload that exacerbates the speed issue.

Note that when Web-based mail is combined with other methods such as POP3, care must be taken to avoid strange results. If the Web interface doesn’t provide all the features of the conventional e-mail client, certain changes made by the client may not show up when Web-based access is used. Also, mail retrieval using POP3 by default removes the mail from the server. If you use POP3 to read your mailbox and then later try to use the Web to access those messages from elsewhere, you will find that the mail is “gone”—it’s on the client machine where you used the POP3 client. Many e-mail client programs now allow you to specify that you want the mail left on the server after retrieving it using POP3.



Key Concept: In the last few years a new method has been developed to allow e-mail access using the *World Wide Web (WWW)*. This technique is growing in popularity rapidly, because it provides many of the benefits of direct server access, such as the ability to receive e-mail anywhere around the world, while being much simpler and easier than the older methods of direct access such as making a Telnet connection to a server. WWW-based e-mail can in some cases be used in combination with other methods or protocols, such as POP3, giving users great flexibility in how they read their mail.

Usenet (Network News) and the TCP/IP Network News Transfer Protocol (NNTP)

Electronic mail is one of the “stalwarts” of message transfer on the modern Internet, but is really designed only for communication within a relatively small group of specific users. There are many situations in which e-mail is not ideally suited, such as when information needs to be shared amongst a large number of participants, not all of whom may necessarily even know each other. One classic example of this is sharing *news*; the person providing news often wants to make it generally available to **anyone** who is interested, rather than specifying a particular set of recipients.

For distributing news and other types of general information over internetworks, a messaging system called both *Usenet* (for *user's network*) and *Network News* was created. This application is like e-mail in allowing messages to be written and read by large numbers of users. However, it is designed using a very different model than e-mail, focused on public sharing and feedback. In Usenet, anyone can write a message that can be read by any number of recipients, and can likewise respond to messages written by others. Usenet was one of the first widely-deployed internetwork-based group communication applications, and has grown into one of the largest online communities in the world, used by millions of people for sharing information, asking questions and discussing thousands of different topics.

In this section I describe Usenet in detail, discussing in two subsections how it is used and how it works. The first subsection covers Usenet in general terms, discussing its history and the model it uses for communication and message storage and formatting. The second describes the Network News Transfer Protocol (NNTP), the protocol currently used widely to implement Usenet communication in TCP/IP.

Many people often equate the Usenet system as a whole with the NNTP protocol that is used to carry Usenet messages on the Internet. They are not the same however; Usenet predates NNTP, which is simply a protocol for conveying Usenet messages. Usenet old-timers will be quick to point this out, if you try to say Usenet and NNTP are the same on Usenet itself. ☺ This is one of the reasons why I have separated my discussion into two subsections. In the overview of Usenet I do briefly discuss the methods other than NNTP that have been used in the past to move Usenet messages, but since they are not widely used today I do not place a great deal of emphasis on them.



Background Information: There are several aspects of how Usenet works that are closely related to the standards and techniques used for e-mail. I assume in this section that you have basic familiarity with how e-mail works. If you have not read the section on e-mail, please at least review [the overview of the e-mail system](#), and also read the section on the [e-mail message format](#), since Usenet messages are based directly on the RFC 822 e-mail message standard.

Usenet Overview, Concepts and General Operation

Where [electronic mail](#) is the modern equivalent of the hand-written letter or the inter-office memo, *Usenet* is the updated version of the company newsletter, the cafeteria bulletin board, the coffee break chat, and the water cooler gossip session, all rolled into one. Spread worldwide over the Internet, Usenet newsgroup messages provide a means for people with common interests to form online communities, to discuss happenings, solve problems, and provide support to each other—as well as facilitating plain old socializing and entertainment.

In this section I discuss Usenet as a whole and how it operates. I begin with an overview and history of Usenet. I then provide a high-level look at the model of communication employed by Usenet, discussing how messages are created, propagated, stored and read. I discuss the Usenet addressing mechanism, which takes the form of a hierarchical set of *newsgroups*. I also explain how Usenet messages are formatted and discuss the special headers that provide information about a message and control how it is displayed and communicated.

Usenet Overview, History and Standards

We are by nature both highly social and creative animals, and as a result, are always finding new ways to communicate. It did not take long after computers were first connected together for it to be recognized that those interconnections provided the means to link together *people* as well. The desire to use computers to create an *online community* led to the creation of Usenet over two decades ago.

History of Usenet

Like almost everything associated with networking, Usenet had very humble beginnings. In 1979, Tom Truscott was a student at Duke University in North Carolina, and spent the summer as an intern at Bell Laboratories, the place where the UNIX operating system was born. He enjoyed the experience so much that when he returned to school that autumn, he missed the intensive UNIX environment at Bell Labs. He used the *Unix-to-Unix Copy Protocol (UUCP)* to send information from his local machine to other machines and vice-versa, including establishing electronic connectivity back to Bell Labs.

Building on this idea, Truscott and a fellow Duke student, Jim Ellis, teamed up with other UNIX enthusiasts at Duke and the nearby University of North Carolina at Chapel Hill, to develop the idea of an online community. The goal was to create a system where students could use UNIX to write and read messages, to allow them to obtain both technical help and maintain social contacts. The system was designed based on an analogy to an online newsletter that was open to all users of a connected system. To share information, messages were posted to *newsgroups*, where any user could access the messages to read them and respond to them as well.

The early work at Duke and UNC Chapel Hill resulted in the development of both the initial message format and the software for the earliest versions of this system, which became known both as *Network News (Net News)* and *Usenet* (a contraction of *User's network*). At

first, the system had just two computers, sharing messages posted in a pair of different newsgroups. The value of the system was immediately recognized, however, and soon many new sites were added to the system. These sites were arranged in a structure to allow messages to be efficiently passed using direct UUCP connections. The software used for passing news articles also continued to evolve and become more capable, as did the software for reading and writing articles.

The newsgroups themselves also changed over time. Many new newsgroups were created, and a hierarchical structure defined to help keep the newsgroups organized in a meaningful way. As more sites and users joined Usenet, more areas of interest were identified. Today there are a staggering number of Usenet newsgroups: over 100,000. While many of these groups are not used, there are many thousands of active ones that discuss nearly every topic imaginable, from space exploration, to cooking, to biochemistry, to PC troubleshooting, to raising horses. There are also regional newsgroups devoted to particular areas; for example, there is a set of newsgroups for discussing events in Canada; another for discussing happenings in the New York area, and so on.

Overview of Usenet Operation and Characteristics

Usenet begins with a user writing a message to be distributed. After the message is *posted* to say, the group on TCP/IP networking, it is stored on that user's local news server, and special software sends copies of it to other connected news servers. The message eventually propagates around the world, where anyone who chooses to read the TCP/IP networking newsgroup can see the message.

The real power of Usenet is that after reading a message, any user can respond to it on the same newsgroup. Like the original message, the reply will propagate to each connected system, including the one used by the author of the original message. This makes Usenet very useful for sharing information about recent happenings, for social discussions, and especially for receiving assistance about problems, such as resolving technical glitches or getting help with a diet program.

What is particularly interesting about Usenet is that it is not a formalized system in any way, and is not based on any formally defined standards. It is a classic example of the development of a system in an entirely “ad hoc” manner; the software was created, people started using it, the software was refined, and things just took off from there. Certain standards have been written to codify how Usenet works—such as RFC 1036, which describes the Usenet message format—but these serve more as historical documents than as prescriptive standards.

There is likewise no “central authority” that is responsible for Usenet's operation, even though new users often think there is one. Unlike a dial-up bulletin board system or Web-based forum, Usenet works simply by virtue of cooperation between sites; there is no “manager in charge”. Usenet is for this reason sometimes called an “anarchy”, but this is not accurate. It isn't the case that there are no rules, only that it is the managers of participating systems that make policy decisions such as what newsgroups to support. There are also certain “dictatorial” aspects of the system, in that only certain people (usually system

administrators) can decide whether to create some kinds of new newsgroups. The system also has “socialistic” elements in that machine owners are expected to share messages with each other. So the simplified political labels really don't apply to Usenet at all.

Every community has a *culture*, and the same is true of online communities, including Usenet. There is an overall culture that prescribes acceptable behavior on Usenet, and also thousands of newsgroup-specific “cultures” in Usenet, each of which has evolved through the writings of thousands of participants over the years. There are even newsgroups devoted to explaining how Usenet itself operates, where you can learn about *newbies* (new users), *netiquette* (rules of etiquette for posting messages) and related subjects.

Usenet Transport Methods

As I said earlier, Usenet messages were originally transported using UUCP, which was created to let UNIX systems communicate directly, usually using telephone lines. For many years, all Usenet messages were simply sent from machine to machine using computerized telephone calls (just as e-mail once was). Each computer joining the network would connect to one already on Usenet and receive a *feed* of messages from it periodically; the owner of that computer had in turn to agree to provide messages to other computers.

Once TCP/IP was developed in the 1980s and the Internet grew to a substantial size and scope, it made sense to start using it to carry Usenet messages rather than UUCP. The *Network News Transfer Protocol (NNTP)* was developed specifically to describe the mechanism for communicating Usenet messages over TCP. It was formally defined in RFC 977, published in 1986, with NNTP extensions described in RFC 2980, October 2000.

For many years Usenet was carried using both NNTP and UUCP, but NNTP is now the mechanism used for the vast majority of Usenet traffic, and for this reason is the primary focus of my Usenet discussion in this Guide. NNTP is employed not only to distribute Usenet articles to various servers, but also for other client actions such as posting and reading messages. It is thus used for most of the steps in Usenet message communication.

It is because of the critical role of NNTP and the Internet in carrying messages in today's Usenet that the concepts are often confused. It's essential to remember, however, that Usenet does not refer to any type of physical network or internetworking technology; rather, it is a **logical** network of users. That logical network has evolved from UUCP data transfers to NNTP and TCP/IP, but Usenet itself is the same.

Today, Usenet faces “competition” from many other group messaging applications and protocols, including Web-based bulletin board systems and chat rooms. After a quarter of a century, however, Usenet has established itself and is used by millions of people every day. While to some, the primarily text-based medium seems archaic, it is a mainstay of global group communication and likely to continue to be so for many years to come.



Key Concept: One of the very first online electronic communities was set up in 1979 by university students who wanted to keep in touch and share news and other information. Today, this *User's Network (Usenet)*, also called *Network News*, has grown into a logical network that spans the globe. By posting messages to a Usenet newsgroup, people can share information on a variety of subjects of interest. Usenet was originally implemented in the form of direct connections established between participating hosts; today the Internet is the vehicle for message transport

Usenet Communication Model: Message Composition, Posting, Storage, Propagation and Access

When the students at Duke University decided to create their online community, electronic mail was already in wide use, and there were many [mailing lists](#) in operation as well. E-mail was usually transported using UUCP during these pre-Internet days, the same method that Usenet was designed to employ. The obvious question then was, why not simply use e-mail to communicate between sites?

The main reason is that e-mail is not really designed to facilitate the creation of an online community where information can be easily shared in a group. The main issue with e-mail in this respect is that only the individuals who are specified as recipients of a message can read it. There is no facility whereby someone can write a message and put it in an open place where anybody who wants can read it, analogous to posting a newsletter in a public place.

Another problem with e-mail in large groups is related to efficiency: if you put 1,000 people on a mailing list, each message sent to that list must be duplicated and delivered 1,000 times. Early networks were limited in bandwidth and resources; using e-mail for wide-scale group communication was possible, but far from ideal.



Key Concept: While electronic mail can be used for group communications, it has two important limitations. First, a message must be specifically addressed to each recipient, making public messaging impossible. Second, each recipient requires delivery of a separate copy of the message, so sending a message to many recipients means the use of a large amount of resources.

Usenet's Public Distribution Orientation

To avoid the problems of using e-mail for group messaging, Usenet was designed using a rather different communication and message-handling model than e-mail. The defining difference between the Usenet communication model and that used for e-mail is that Usenet message handling is oriented around the concept of *public distribution*, rather than private delivery to an individual user. This affects every aspect of how Usenet communication works:

-
- ④ **Addressing:** Messages are not addressed from a sender to any particular recipient or set of recipients, but rather to a *group*, which is identified with a newsgroup name.
 - ④ **Storage:** Messages are not stored in individual mailboxes but in a central location on a server, where any user of the server can access them.
 - ④ **Delivery:** Messages are not conveyed from the sender's system to the recipient's system, but are rather spread over the Internet to *all* connected systems so anyone can read them.

The Usenet Communication Process

To help illustrate in more detail how Usenet communication works, let's take a look at the steps involved in the writing, transmission and reading of a typical Usenet message (also called an *article*—the terms are used interchangeably). Let's suppose the process begins with a user, Ellen, posting a request for help with a sick horse to the [newsgroup misc.rural](#). Since she is posting the message, she would be known as the message *poster*. Simplified, the steps in the process (illustrated in [Figure 310](#)) are as follows:

1. **Article Composition:** Ellen begins by creating a Usenet article, which is structured according to the [special message format required by Usenet](#). This message is similar to an electronic mail message in that it has a *header* and a *body*. The body contains the actual message to be sent, while the header contains header lines that describe the message and control how it is delivered. For example, one important header line specifies which newsgroup(s) for which the article is intended.
2. **Article Posting and Local Storage:** After completing her article, Ellen submits the article to Usenet, a process called *posting*. A client software program on Ellen's computer transmits Ellen's message to her local Usenet server. The message is stored in an appropriate file storage area on that server. It is now immediately available to all other users of that server who decide to read *misc.rural*.
3. **Article Propagation:** At this point, Ellen's local server is the only one that has a copy of her message. The article must be sent to other sites, a process called *distribution*, or more commonly, *propagation*. Ellen's message would travel from her local Usenet server to other servers to which her server directly connects. It would then in turn propagate from those servers to others *they* connect to, and so on, until all Usenet servers that want it have a copy of the message.
4. **Article Access and Retrieval:** Since Usenet articles are stored on central servers, in order to read them they must be accessed on the server. This is done using a Usenet *newsreader* program. For example, some other reader of *misc.rural* named Jane might access that group and find Ellen's message. If Jane was able to help Ellen she could reply to Ellen by posting an article of her own. This would then propagate back to Ellen's server, where she could read it and reply in turn. Of course, all other readers of *misc.rural* could jump in to the conversation at any time as well, which is what makes Usenet so useful for group communication.

Message Propagation and Server Organization

Propagation is definitely the most complex part of the Usenet communication process. In the “olden dayse”, UUCP was used for propagation; each Usenet server would be programmed to regularly dial up another server and give it all new articles it had received

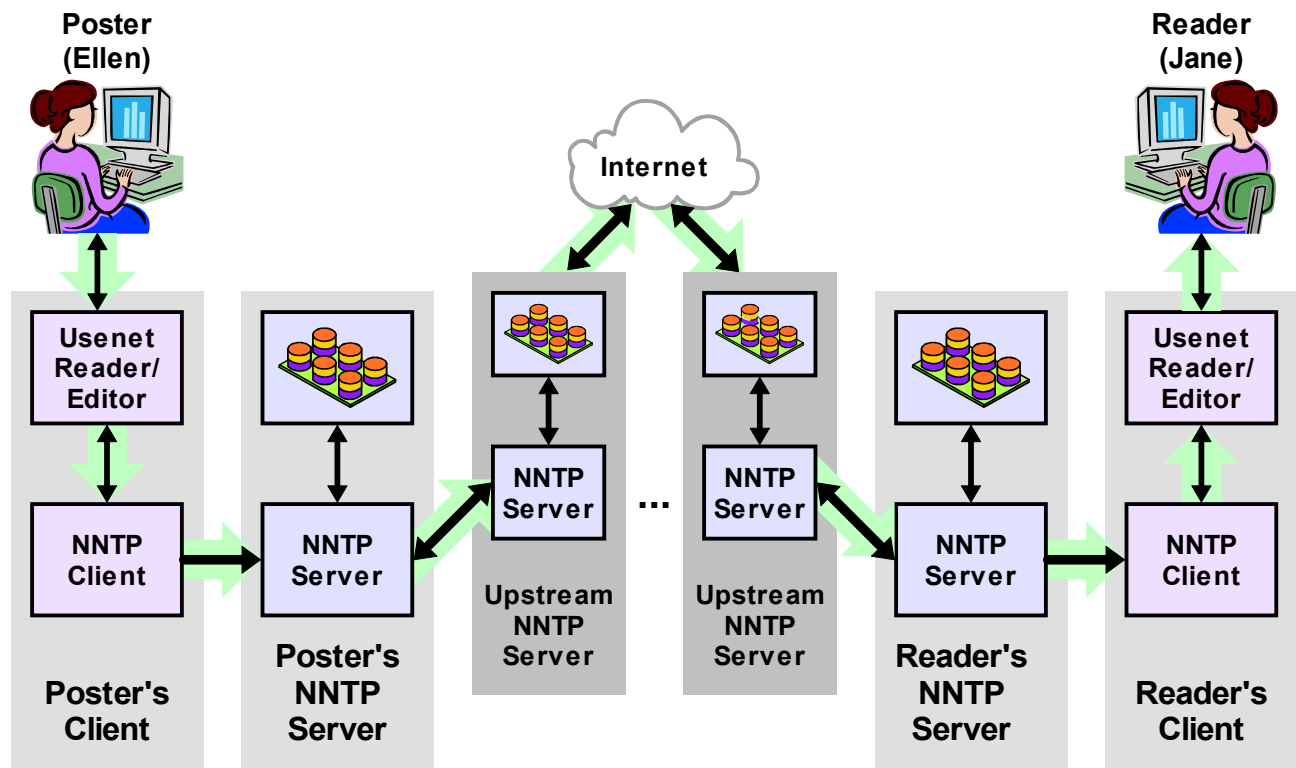

Figure 310: Usenet (Network News) Communication Model

This figure illustrates the method by which messages are created, propagated and read using NNTP on modern Usenet; it is similar in some respects to the e-mail model diagram of [Figure 301](#). In this example a message is created by the *poster*, Ellen, and read by a *reader*, Jane. The process begins with Ellen creating a message in an editor and posting it. Her NNTP client sends it to her local NNTP server. It is then propagated from that local server to adjacent servers, usually including its *upstream* server, which is used to send the message around the Internet. Other NNTP servers receive the message, including the one upstream from Jane's local server. It passes the message to Jane's local server, and Jane accesses and reads the message using an NNTP client.

Jane could respond to the message, in which case the same process would repeat, but going in the opposite direction, back to Ellen (and of course, also back to thousands of other readers, not shown here.)

since the last connection. Articles would *flood* across Usenet from one server to another. This was time-consuming and inefficient, however, and only worked because the volume of articles was relatively small.

In modern Usenet, the [Network News Transfer Protocol \(NNTP\)](#) is used for all stages of transporting messages between devices. Articles are posted using an NNTP connection between a client machine and a local server, which then uses the same protocol to propagate the articles to other adjacent NNTP servers. NNTP is also used by client newsreader software to retrieve messages from a server.

NNTP servers are usually arranged in a hierarchy of sorts, with the largest and fastest servers providing service to smaller servers "downstream" from them. Depending on how the connections are arranged, an NNTP server may either establish a connection to

immediately send a newly-posted article to an “upstream” server for distribution to the rest of Usenet, or the server may passively wait for a connection from the upstream server to ask if there are any new articles to be sent. With the speed of the modern Internet, it typically takes only a few minutes or even seconds for articles to propagate from one server to another, even across continents.

It is also possible to restrict the propagation of a Usenet message, a technique often used for discussions that are only of relevance in certain regions or on certain systems. Discussing rural issues such as horses is of general interest, and Ellen might well find her help anywhere around the world, so global propagation of her message makes sense. However, if Ellen lived in the Boston area and was interested in knowing the location of a good local steak-house, posting a query to *ne.food* (New England food discussions) with only local distribution would make more sense. There are also companies that use Usenet to provide “in-house” newsgroups that are not propagated off the local server at all. Note, however, that because so many news providers are now national or international, limiting the distribution of messages has largely fallen out of practice.

This is, of course, only a simplified look at Usenet communication. [The section on NNTP](#) provides more details, especially on how articles are handled and propagated.



Key Concept: Usenet communication consists of four basic steps. A message is first *composed* and then *posted* to the originator’s local server. The third step is *propagation*, where the message is transmitted from its original server to others on the Usenet system. The last step in the process is *article retrieval*, where other members of the newsgroup access and read the article. The *Network News Transfer Protocol (NNTP)* is the technology used for moving Usenet articles from one host to the next.

Usenet Addressing: Newsgroups, Newsgroup Hierarchies and Types

As [the previous topic](#) mentioned, a key concept in Usenet communication is the *newsgroup*. Newsgroups are in fact the addressing mechanism for Usenet, and sending a Usenet article to a newsgroup is equivalent to sending e-mail to an [electronic mail address](#). Newsgroups are analogous to other group communication venues such as mailing lists, chat rooms, [Internet Relay Chat](#) channels or BBS forums—though calling a newsgroup a “list”, “room”, “channel” or “BBS” is likely to elicit a negative reaction from Usenet old-timers.

Like any addressing mechanism, newsgroups must be uniquely identifiable. Each newsgroup has a *newsgroup name* that describes what the topic of the newsgroup is about, and differentiates it from other newsgroups. Since there are many thousands of different newsgroups, they are arranged into sets called *hierarchies*. Each hierarchy contains a tree structure of related newsgroups.

Usenet Newsgroup Hierarchies

The total collection of newsgroup hierarchies is in many ways similar to the [domain name tree structure used in DNS](#). Each Usenet hierarchy is like a collection of all the domain names within a DNS [top-level domain](#). Just as a domain name like `www.pcguid.com` is formed by appending the label of the top level domain “com” to the second-level domain name “pcguide” and the subdomain “www”, newsgroup names are created in the same way. They are created from a top-level newsgroup hierarchy name, to which are attached a set of descriptive label that describe the newsgroup's place in the hierarchy.

One difference between DNS and Usenet hierarchies is that while [DNS names are created from right to left](#) as you go “down the tree”, Usenet newsgroup names are formed in the more “natural” (for English speakers) left to right order. For example, one of the main Usenet hierarchies is the “comp” hierarchy, devoted to computer topics. Within “comp” is a sub-hierarchy on data communications called “dcom”, and within that a group that discusses data cabling. This group is called `comp.dcom.cabling`. Almost all newsgroups are structured in this manner.

The “Big Eight” Newsgroup Hierarchies

One problem with the “decentralized, anarchistic” nature of Usenet is ensuring coordination in certain areas where we want everyone to be on the same page; one of these is newsgroup naming. If we let just anyone create a newsgroup, we might well end up with many, even dozens of groups that all discuss the same topic. Imagine that someone had a question on data cabling and didn't realize that `comp.dcom.cabling` existed, so they created a new group called `comp.datacomm.cabling`. The two groups could coexist, but this would lead to both confusion and fragmenting of the pool of people interested in this topic.

To avoid this problem, many of the administrators of large Usenet systems collaborated on a system for organizing many of the more commonly-used Usenet groups into eight hierarchies, and devised a specific procedure for creating new newsgroups within them. There is actually a long history behind how this came about; these are today called the *Big Eight* Usenet hierarchies, and are summarized in [Table 264](#).

Table 264: Usenet “Big Eight” Newsgroup Hierarchies

Hierarchy	Description
comp.*	Newsgroups discussing computer-related topics, including hardware, software, operating systems and techniques.
humanities.*	Groups discussing the humanities, such as literature and art.
misc.*	Miscellaneous topics that don't fit into other Big Eight hierarchies.
news.*	Groups discussing Usenet itself and its administration.
rec.*	Recreation topics, such as games, sports and activities.
sci.*	Science newsgroups, covering specific areas such as physics and chemistry, research topics and so forth.

Table 264: Usenet “Big Eight” Newsgroup Hierarchies

Hierarchy	Description
soc.*	Society and social discussions, including groups on specific cultures.
talk.*	Groups primarily oriented around discussion and debate of current events and happenings.

These eight hierarchies contain many of the most widely-used groups on Usenet today. For example, professional baseball is discussed in *rec.sport.baseball*, Intel computers in *comp.sys.intel* and Middle East politics in *talk.politics.mideast*.

The Big Eight hierarchies are rather tightly controlled in terms of their structure and the newsgroups they contain. The process to create a new Big Eight newsgroup is democratic and open; anyone can propose a new group and if there is enough support, it will be created by the cooperating system administrators who agree to follow the Big Eight system. However, this creation process is rather complex and time-consuming. Some people find this unacceptable and even object to the entire concept of this restricted process; others consider it advantageous, as it keeps the Big Eight hierarchies relatively “orderly” by slowing the rate of change to existing newsgroups and the number of new groups added.

Other Newsgroup Hierarchies

For those who prefer a more free-wheeling environment and do not want to submit to the Big Eight procedures, there is the “alternative” Usenet hierarchy, which begins with the hierarchy name *alt*. This hierarchy includes many thousands of groups. Some are quite popular, but many are not used at all; this is a side-effect of the relative ease with which an alt group can be created.

In addition to these nine hierarchies there are dozens of additional, smaller hierarchies. Many of these are regional or even company-specific. For example, the “ne.” hierarchy contains a set of newsgroups discussing issues of relevance to New England; “fr.*” covers France, and “de.*” Germany. Microsoft has its own set of public newsgroups in the “microsoft.*” hierarchy. [Figure 311](#) shows the Big Eight hierarchies and some of the other hierarchies that exist.



Key Concept: Usenet messages are not addressed to individual users; rather, they are posted to *newsgroups*. Each newsgroup represents a topic; those with an interest in the subject of a group can read messages in it, and reply to them as well. Usenet newsgroups are arranged into tree-like *hierarchies* that are similar in structure to DNS domains. Many of the most widely-used newsgroups are found in a collection of general-interest hierarchies called the *Big Eight*. There are also many regional and special-purpose hierarchies.

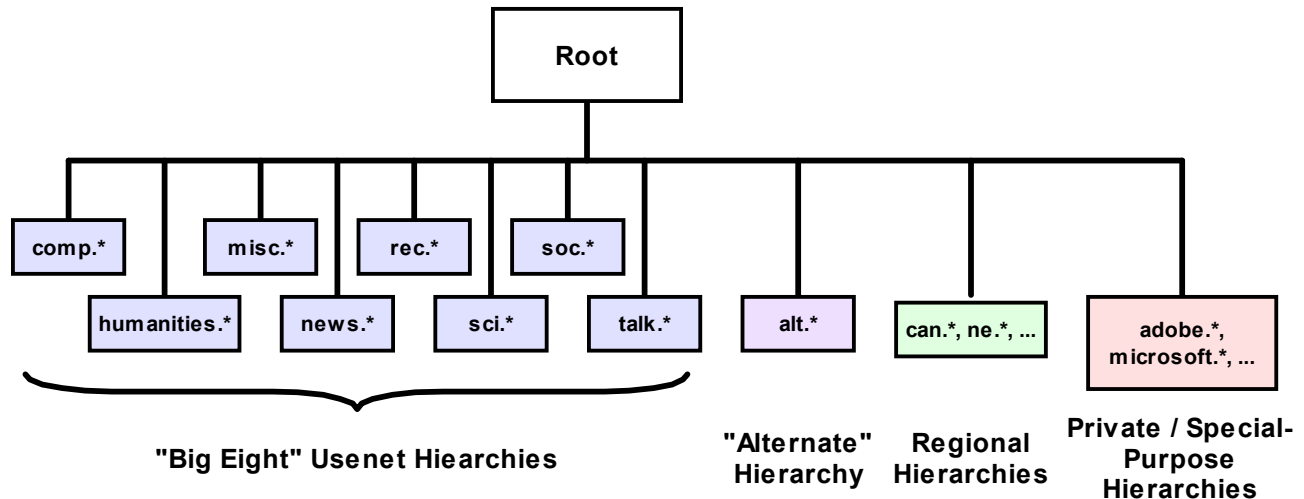

Figure 311: Usenet Newsgroup Hierarchies

Usenet newsgroups are arranged into tree-like structures called *hierarchies*. Eight of these are centralized, widely-used, general-purpose hierarchies, which are today called the “Big Eight”. The “alternate” (“alt”) hierarchy is a very loosely-structured set of thousands of groups covering every topic imaginable. In addition to these, there are many hundreds of regional, private and special-purpose hierarchies.

Unmoderated and Moderated Newsgroups

Most newsgroups are open to all to use, and are called *unmoderated* because a message sent to them goes directly out to the whole Usenet server internetwork. In contrast, a small percentage of newsgroups is *moderated*, which means that all messages sent to the group are screened and only the ones that are approved by a moderator (or moderator team) are really posted.

The purpose of moderated groups is to ensure that discussions in a particular group remain on-topic. They are often created to handle topics that are controversial, to ensure that debates remain constructive and disruption is avoided. For example, *rec.guns* is moderated to ensure that discussions focus on the use of guns and not on endless political arguments related to gun control and the like (which has a place, in *talk.politics.guns*).

Moderated groups are also sometimes used for specialty groups intended only for announcements, or for groups where the content is restricted. For example, *rec.food.recipes* is moderated so that it only contains recipes and recipe requests; this helps people find recipes easily without having to wade through lots of discussion. Finally, moderated versions of unmoderated groups are sometimes created when a few disruptive elements choose to post large volumes in the unmoderated groups, making normal discussion difficult.

Cross-Posting to Multiple Newsgroups

It is possible for a single article to be posted to multiple newsgroups. This process, called *cross-posting*, is used when a message pertains to two topics, or to allow a sender to reach a wider audience. For example, if I live in the Seattle area and have a problem with my house, I might legitimately cross-post to *seattle.general* and *misc.consumers.house*.

This is more efficient than posting the same message to each group independently for two reasons. First, only one copy of the message will be stored on each Usenet server rather than two. Second, Usenet participants who happen to read both groups won't see the message twice. However, cross-posting to very large numbers of newsgroups is usually considered disruptive and a breach of Usenet etiquette.

Usenet Message Format and Special Headers

Usenet is designed to permit users to exchange information in the form of messages that are sent from one computer to another. Like any [message-based networking application](#), it is necessary that all Usenet client and server software agree to use a common *message format*. This ensures that all devices and programs are able to interpret all Usenet articles in a consistent manner.

General Message Format

While Usenet was created as an alternative to e-mail, and there are obviously differences in how each treats messages, there are also many similarities. Both are text-oriented messaging systems with similar needs for communicating both content and control information. The creators of Usenet realized that there would be many advantages to basing the Usenet message format on the one used for e-mail, rather than creating a new format from scratch. For one thing, the e-mail message format was already widely used, and adopting it for Usenet would save implementation time and effort. It would also enhance compatibility between e-mail and Usenet messages, allowing software designed to process or display e-mail to also work with Usenet articles.

For this reason, the Usenet message format was defined based on the [RFC 822 standard for e-mail messages](#), discussed thoroughly in its own subsection of [the section on e-mail](#) in this Guide. RFC 822 messages begin with a set of *headers* that contain control and descriptive information about the message, followed by a blank line and then the message *body*, which contains the actual content.

One important attribute of the RFC 822 standard is the ability to define custom headers that add to the regular set of headers defined in the standard itself. Usenet articles require some types of information not needed by e-mail, and these can be included in specially-defined headers while still adhering to the basic RFC 822 format. At the same time, headers specific to e-mail that are not needed for Usenet can be omitted.

Thus, there is no structural difference at all between a Usenet article and an e-mail message; they differ only in the kinds of headers they contain, and the values for those headers. For example, a Usenet message will always contain a header specifying the newsgroup(s) to which the article is being posted, but will not carry a “To:” line as an e-mail message would.



Key Concept: Usenet articles use the same *RFC 822* message format as electronic mail messages. The only difference between a Usenet article and e-mail message is in the header types and values used in each.

Usenet Header Categories and Common Headers

All Usenet headers are defined according to the standard header format defined in RFC 822:

<header name>: <header value>

As with e-mail messages, headers may extend on to multiple lines, following the [indenting procedure described in the RFC 822 standard](#).

The current standard for Usenet messages, RFC 1036, describes the header types for Usenet messages. The headers are divided into two categories: *mandatory* headers and *optional* headers. Some are the same as headers of the equivalent name used for e-mail, some are similar to e-mail headers but used in a slightly different way, while others are unique to Usenet. [Table 265](#) describes these header fields and how they are used.

Table 265: Usenet Header Categories and Headers (Page 1 of 2)

Header Category	Header Name	Description
Mandatory Headers	<i>From:</i>	The e-mail address of the user sending the message, as for e-mail.
	<i>Date:</i>	The date and time that the message was originally posted to Usenet. This is usually the date/time that the user submitted the article to his or her local NNTP server.
	<i>Newsgroups:</i>	Indicates the newsgroup or set of newsgroups to which the message is being posted. Multiple newsgroups are specified by separating them with a comma; for example: "Newsgroups: news.onegroup,rec.secondgroup".
	<i>Subject:</i>	Describes the subject or topic of the message. Note that this header is mandatory on Usenet despite being optional for e-mail; it is important because it is used by readers to decide what messages to open.
	<i>Message-ID:</i>	Provides a unique code for identifying a message; normally generated when a message is sent. The message ID is very important in Usenet, arguably more so than in e-mail. The reason is that delivery of e-mail is performed based on recipient e-mail addresses, while the propagation of Usenet messages is controlled using the message ID header.
Optional Headers (part 1 of 2)	<i>Reply-To:</i>	It is possible to reply back to a Usenet article author using e-mail, which by default goes to the address in the <i>From:</i> line. If this header is present, the address it contains is used instead of the default <i>From:</i> address.
	<i>Sender:</i>	This header indicates the e-mail address of the user who is sending the message, if different from the message originator. This is functionally the same as the <i>Sender:</i> header in e-mail messages, but is used in a slightly different way. Normally, when a Usenet message is posted, the sender's e-mail address is automatically filled in to the <i>From:</i> line. If the user manually specifies a different <i>From:</i> line, the address from which the message was actually sent is usually included in the <i>Sender:</i> line. This is used to track the true originating point of articles.
	<i>Followup-To:</i>	<p>A reply to a Usenet message is usually made back to Usenet itself, and is called a <i>follow-up</i>. By default, a follow-up goes to the newsgroup(s) specified in the original message's <i>Newsgroups:</i> header. However, if the <i>Followup-To:</i> header is included, follow-ups to that message go to the newsgroups specified in the <i>Followup-To:</i> header instead.</p> <p>This header is sometimes used to "route" replies to a message to a particular group. Note, however, that when a user replies to a message, this field only controls what appears in the new message's <i>Newsgroups:</i> line by default. The user can override the <i>Newsgroups:</i> header manually.</p>

Table 265: Usenet Header Categories and Headers (Page 2 of 2)

Header Category	Header Name	Description
Optional Headers (part 2 of 2)	<i>Expires:</i>	All Usenet messages are maintained on each server for only a certain period of time, due to storage limitations. The expiration interval for each newsgroup is controlled by the administrator of each site. If present, this line requests a different expiration for a particular message; it is usually used only for special articles. For example, if a weekly announcement is posted every Monday morning, each article might be set to expire the following Monday morning, to make sure that people see the most current version.
	<i>References:</i>	This header lists the message IDs of prior messages in a conversation. For example, if someone posts a question to a newsgroup with message ID "AA207", and a reply to that message is made, the software will automatically insert the line "References: AA207" into the reply. This is used by software to group together articles into conversations (called <i>threads</i>) to make it easier to follow discussions on busy newsgroups.
	<i>Control:</i>	Indicates that the article is a control message and specifies a control action to be performed, such as creating a new newsgroup.
	<i>Distribution:</i>	By default, most messages are propagated on Usenet worldwide. If specified, this line restricts the distribution of a message to a smaller area, either geographical or organizational.
	<i>Organization:</i>	Describes the organization to which the article sender belongs. Often filled in automatically with the name of the user's Internet Service Provider.
	<i>Keywords:</i>	Contains a list of comma-separated keywords that may be of use to the readers of the message. Keywords can be useful when searching for messages on a particular subject matter. This header is not often used.
	<i>Summary:</i>	A short summary of the message; again, rarely used in practice.
	<i>Approved:</i>	This header is added by the moderator of a moderated newsgroup to tell the Usenet software that the message has been approved for posting.
	<i>Lines:</i>	A count of the number of lines in the message.
	<i>Xref:</i>	While Usenet articles are identified by message ID, they are also given a number by each Usenet server as they are received. These article numbers, which differ from one system to the next, are usually listed in this cross-reference header. This information is used when a message is cross-posted to multiple groups. In that case, as soon as a user reads the message in one group, it is marked as having been read in all the others where it was posted. This way, if the user later reads one of those other groups, they will not see the message again.

Additional Usenet Headers

Usenet messages may also contain additional headers, just as is the case with e-mail messages. Some of these headers are entirely "custom" and are included by individual users to provide extra information about an article. Others are used in many or even most

current Usenet articles, and have become almost “de facto” standard headers through common use. Many of these custom headers are preceded by “X-”, indicating that they are “experimental” or “extra” headers.

Some of the more frequently encountered “additional” Usenet headers are shown in [Table 266](#).

Table 266: Common Additional Usenet Headers

Header Name	Description
NNTP-Posting-Host:	Specifies the IP address or the DNS domain name of the host used to originally post the message. This is usually either the address of the client that the author used for posting the message, or the sender's local NNTP server.
User-Agent: (or) X-Newsreader:	The name and version number of the software used to post the message.
X-Trace:	Provides additional information that can be used to trace the message.
X-Complaints-To:	An e-mail address to use to report abusive messages. This header is now included automatically by many Internet Service Providers.

Usenet MIME Messages

Since Usenet follows the RFC 822 standard, [Multipurpose Internet Mail Extensions \(MIME\)](#) can be used to format Usenet messages. When this is done, you will see the usual [MIME headers](#) (such as *MIME-Version*, *Content-Type* and so forth) in the message.

Note that the use of MIME in Usenet messages is somewhat controversial. Some newsreaders are not MIME-compliant and make a mess when trying to display some of these messages, and many Usenet veterans object to the use of anything but plain text in Usenet messages. Despite this, MIME messages are becoming more common, for better or worse.



TCP/IP Network News Transfer Protocol (NNTP)

[Usenet](#) started out as an informal network of UNIX computers using dial-up UUCP connections to transmit messages between servers. This arrangement arose out of necessity, and it worked fairly well, though it had a number of problems. Once the Internet became widely used in the 1980s, it provided the ideal opportunity for a more efficient means of distributing Usenet articles. A special TCP/IP protocol was developed for sending these messages, called the *Network News Transfer Protocol (NNTP)*. NNTP is used today to carry billions of copies of Usenet messages from computer to computer every day.

In this section I provide a detailed description of the operation of the Network News Transfer Protocol. I begin with an overview of how NNTP works in general terms. I then explain the two fundamental ways that NNTP is used: for the propagation of news articles between servers, and for client article posting and access. I then provide more information about standard NNTP commands, as well as the newer NNTP command extensions, and also illustrate NNTP status responses and the common response codes.



Background Information: NNTP is similar to the [Simple Mail Transfer Protocol \(SMTP\)](#) in many ways, including its [basic operation](#) and [command set](#) and [reply format](#). You may therefore find this section easier to understand if you are familiar with SMTP.

NNTP Overview and General Operation

Usenet began as a *logical* internetwork of cooperating hosts that contacted each other directly. In the early Usenet, a user would post a message to his or her local server. There it would stay until that server either contacted or was contacted by another server. The message would then be transferred to the new server, where it would stay until the second server contacted a third one, and so on.

This transport mechanism was functional, but seriously flawed in a number of ways. Servers were not continually connected to each other; they could only communicate by making a telephone call using an analog modem. Thus, messages would often sit for hours before they could be propagated. Modems in those days were also very slow by today's standards—2400 bits per second or even less—so it took a long time to copy a message from one server to another. Worst of all, unless two sites were in the same city, these phone calls were long distance, making them quite expensive.

Why was this system used despite all of these problems? Simple: there was no alternative. In the late 1970s and early 1980s, there was no Internet as we know it, and no other physical infrastructure existed to link Usenet sites together. It was either use UUCP over telephone lines, or nothing.

The Development of NNTP

Everything changed as the fledgling [ARPAnet](#) grew into the modern Internet. As the Internet expanded, more and more sites connected to it, including many sites that were participating in Usenet. Once a pair of sites were both on the Internet, it was an easy decision to use the Internet to send Usenet articles rather than slow, expensive telephone calls. Over time, more and more Usenet sites joined the Internet, and it became clear that just as e-mail had moved from UUCP to the TCP/IP Internet, the future of Usenet was on the Internet as well.

The shifting of Usenet from UUCP connections to TCP/IP internetworking meant that some rethinking was required in how Usenet articles were moved from server to server. On the Internet, Usenet was just one of many applications, and the transfer of messages had to be structured using one of [the two TCP/IP transport protocols](#), TCP or UDP.

Thus, like other applications, Usenet required an [application-level protocol](#) to describe how to carry Usenet traffic over TCP/IP. Just as Usenet had borrowed its message format from [e-mail's RFC 822](#), it made sense to model its message delivery protocol on the one used by e-mail: the [Simple Mail Transfer Protocol \(SMTP\)](#). The result was the creation of the *Network News Transfer Protocol (NNTP)*, published as RFC 977 in February, 1986.

Overview of NNTP Operation

The general operation of NNTP is indeed very similar to that of SMTP. NNTP uses [TCP](#), with servers listening on [well-known TCP port 119](#) for incoming connections, either from client hosts or other NNTP servers. As in SMTP, when two servers communicate using NNTP, the one that initiates the connection plays the role of client for that exchange.

After a connection is established, communication takes the form of commands sent by the client to the server, and replies returned from the server to the client device. [NNTP commands](#) are sent as plain ASCII text, just like those used by SMTP, [FTP](#), [HTTP](#) and other protocols. [NNTP responses](#) take the form of three-digit reply codes as well as descriptive text, again just like SMTP (which in turn borrowed this concept from FTP).

NNTP was designed to be a comprehensive vehicle for transporting Usenet messages. It is usually most often considered as a delivery protocol for moving Usenet articles from one server to another, but is also used for connections from client hosts to Usenet servers for posting and reading messages. Thus, the NNTP command set is quite extensive, and includes commands to handle both inter-server and client-server communication. For [message propagation](#), a set of commands is provided to allow a server to request new articles from another server, or to provide new articles to another server. For [message posting and access](#), commands allow a client to request lists of new newsgroups and messages, and to retrieve messages for display to a user.

The commands defined in RFC 977 were the only “official” ones for over a decade. However, even as early as the late 1980s, implementors of NNTP server and client software were adding new commands and features to make NNTP both more efficient and useful to users. These *NNTP extensions* were eventually documented in RFC 2980, published in 2000. [I describe them in more detail later in this section.](#)



Key Concept: The *Network News Transfer Protocol (NNTP)* is the protocol used to implement message communication in modern Usenet. It is used for two primary purposes: to propagate messages between NNTP servers, and to permit NNTP clients to post and read articles. It is a standalone protocol, but shares many characteristics with e-mail's Simple Mail Transfer Protocol (SMTP).

NNTP Inter-Server Communication Process: News Article Propagation

The Network News Transfer Protocol (NNTP) is used for all of the transfer steps in the modern Usenet communication process. However, NNTP is most often associated with the process of Usenet article *propagation*. This is arguably the most important function of NNTP: providing an efficient means of moving large volumes of Usenet articles from one server to another. It is thus a sensible place to start looking at the protocol.

Understanding the Usenet Server Structure

To see how NNTP propagation works, we must begin with a look at the way that the modern Usenet network itself is organized. Usenet sites are now all on the Internet, and theoretically, any NNTP server can contact any other to send and receive Usenet articles. However, it would be ridiculous to have a new article submitted to a particular server need to be sent via separate NNTP connections to each and every other NNTP server. For this reason, the Usenet logical network continues to be very important, even in the Internet era.

In theory, all that is required of the Usenet structure is that each site be connected to at least one other site in some form. The logical network could be amorphous and without any formal structure at all, as long as every site could form a path through some sequence of intermediate servers to each other one. However, modern Usenet is very large, with thousands of servers and gigabytes of articles being posted every day. This calls for a more organized structure for distributing news.

For this reason, the modern Usenet logical network is structured loosely in a hierarchy. A few large Internet Service Providers and big companies with high-speed Internet connections and large servers are considered to be at the top of the hierarchy, in what is sometimes called the Usenet *backbone*. Smaller organizations connect to the servers run by these large organizations; these organizations are considered to be *downstream* from the backbone groups. In turn, still smaller organizations may connect further downstream from the ones connected to the large organizations.

This hierarchical structure means that most Usenet servers only maintain a direct connection to their upstream neighbor, and to any downstream sites to which they provide service. A server is said to receive a *news feed* from its upstream connection, since that is the place from which it will receive most of its news articles. It then provides a news feed to all the servers downstream from it. I illustrated this in [Figure 310](#) in the topic describing the [Usenet communication model](#).

As an example, suppose Company A runs a large Usenet server called *largenews* that is connected to the backbone. Downstream from this server is the NNTP server *mediumnews*. That server in turn provides service to *smallnews*. If a user posts an article to *mediumnews*, it will be placed on that server immediately. That server will send the article downstream, to *smallnews*, so that it can be read by that server's users. *mediumnews* will also, at some point, send the article to *largenews*. From *largenews*, the message will be distributed to other backbone sites, which will in turn pass the message down to their own downstreams. In this way, all sites eventually get a copy of the message, even though *mediumnews* only needs to connect to two other servers directly.

The term used to describe how news is propagated with NNTP is *flooding*. This is because of the way that a message begins in one server and “floods” outward from it, eventually reaching the backbone sites and then going down all the downstream “rivers” to reach every site on Usenet.

Even though I described the logical Usenet network as a hierarchy, it is not a strict hierarchy. For redundancy, many NNTP servers maintain connections to multiple other servers to ensure that news propagates quickly. The transmission of articles can be controlled by looking at message IDs to avoid duplication of messages that may be received simultaneously by one server from more than one neighbor.

Basic NNTP Propagation Methods

Now let's look at how messages are actually propagated between servers using NNTP. There are two techniques by which this can be done:

- ☉ **“Pushing” News:** In the *push model*, as soon as a server receives a new message, it immediately tells its upstream and downstream neighbors about the message and asks them if they want a copy of it.
- ☉ **“Pulling” News:** In the *pull model*, servers do not offer new articles to their neighbors. The neighboring servers must ask for a list of new messages if they want to see what has arrived since the last connection was established, and then request that the new messages be sent to them.

There are advantages and disadvantages to both of these techniques, but pushing is the model most commonly used today.



Key Concept: One important role that NNTP plays is its *propagation* of articles between Usenet servers, which is what makes the entire system possible. Two models are used for article propagation: the *push model*, in which a server that receives a new message offers it to connected servers immediately, and the *pull model*, where servers that receive new messages hold them until they are requested by other servers. The push model is usually preferred since it allows for quicker communication of messages around the system.

Article Propagation Using the "Push" Model

Here's how the push model works. When the administrators of an NNTP server establish a service relationship with an upstream Usenet service provider, they furnish the provider with a list of newsgroups that the downstream server wants to carry. Whenever a new article arrives at the upstream server within that list of groups, it is automatically sent to the downstream site. This saves the downstream server from constantly having to ask "has anything arrived?"

In the classical NNTP protocol as defined in RFC 977, the exchange of articles is based on the push model, and performed using the *IHAVE* command. Suppose three new messages arrive at the *largenews* server. It would establish an NNTP connection to *mediumnews* and use *IHAVE* to provide the message IDs of each of the three new messages, one at a time. The *mediumnews* server would respond to each one indicating whether it already had that message or not. If not, *largenews* would send it the message. An example article transaction using the push model of propagation is illustrated in [Figure 312](#).

The main advantage of this technique is that it ensures that a server is not sent a duplicate copy of a message that it already has. The problem with it in modern Usenet is that it is slow, because the server must respond to the *IHAVE* command before the message or the next command can be sent by the client.

Improving Push Propagation Efficiency With Streaming Mode

Due to the inefficiency problem just described, one of the more important [NNTP extensions](#) is *streaming mode*, which changes how news pushing is done. When this mode is enabled, the client machine uses the *CHECK* command instead of *IHAVE* to ask the server if it wants a particular message. The server responds back as for *IHAVE* to indicate if it wants the message; if it does, the client sends the message with the *TAKETHIS* command.

The benefit of *CHECK/TAKETHIS* is that the client does not have to wait for a reply to *CHECK* before sending the next command. While the client is waiting for a reply to the first *CHECK* command, it can do something else, like sending the next *CHECK* command, allowing commands to be streamed for greater efficiency. So the client could send a *CHECK* command for the first new message, then a *CHECK* for the second while waiting for a reply from the server to the first one. Many *CHECK* commands could be sent in a stream and then *TAKETHIS* commands sent for each reply received to *CHECKs* sent earlier indicating that the message was wanted by the server.

Article Propagation Using the "Pull" Model

The pull model is implemented using the *NEWNEWS* and *ARTICLE* commands. The client connects to the server and sends the *NEWNEWS* command with a date specifying the date and time that it last checked for new messages. The server responds with a set of message IDs for new articles that have arrived since that date. The client then requests each new message using the *ARTICLE* command.

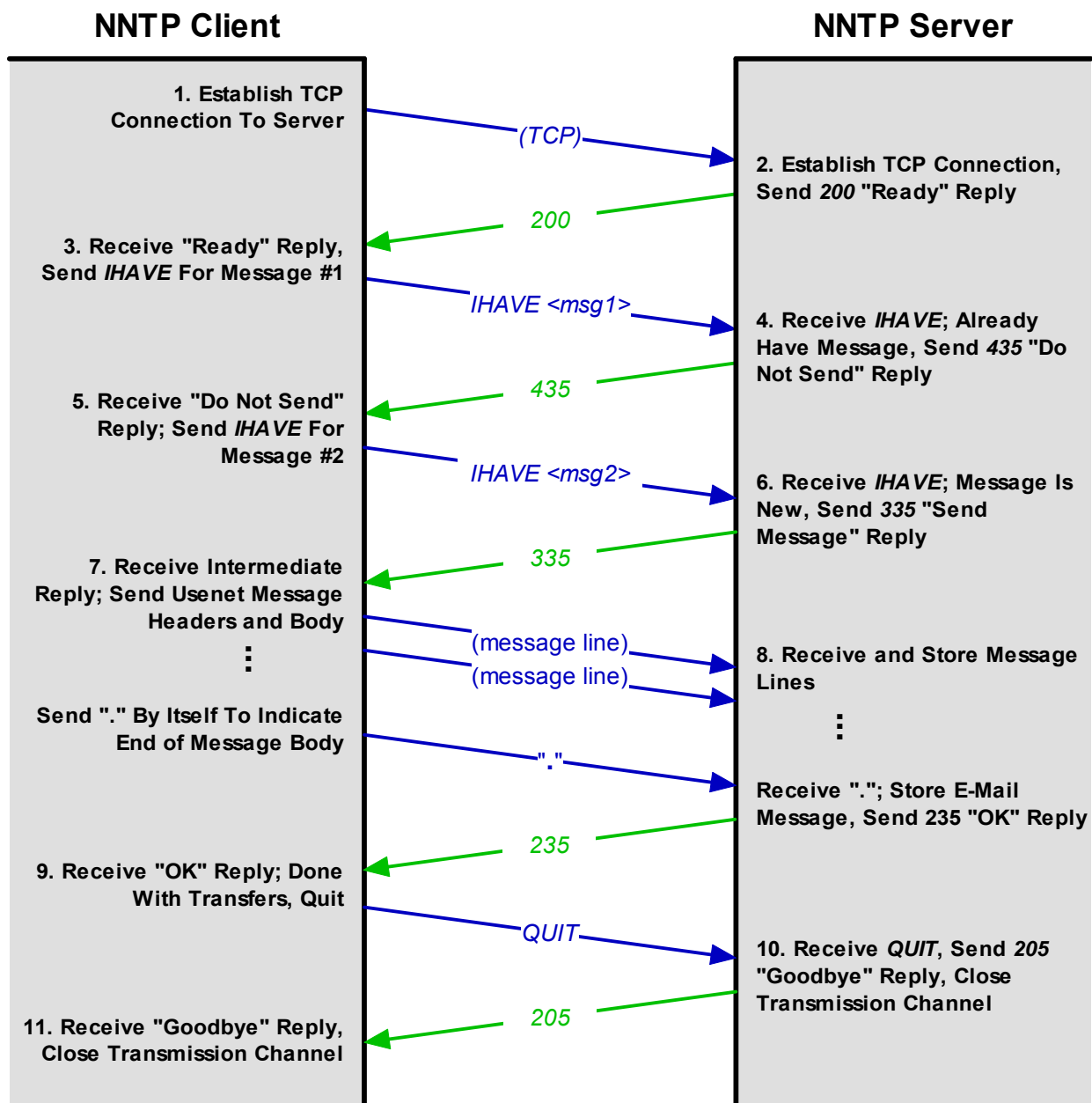

Figure 312: NNTP Article Propagation Using The "Push" Model

This example shows how Usenet articles are moved between servers using the conventional "push" model of propagation. Here, the device acting as an NNTP client (which recall may in fact be an NNTP server) has two messages available to offer to the server. It sends the *IHAVE* command specifying the message ID of the first message, but the server already has that message so it sends a 435 "do not send" reply. The client then issues an *IHAVE* with the second message ID; the server wants this one, so it sends a 335 reply; the client sends the Usenet message, ending with a single period on a line by itself. The server indicates that it received the message and the client, done with its transactions, quits the session.

Note that the push and pull models can be combined in a single session. A client can connect to a server, use *NEWNEWS* to check for new messages on that server, and then *IHAVE* or *CHECK* to inform the server about new messages the client wants to send. In practice, it is more common for only one or the other of the models to be used between a pair of servers on any given exchange.

In addition to propagating new messages, NNTP is also used to allow servers to communicate information about new newsgroups that have been created. This is done using the *NEWGROUPS* command, which is specified with a date and time like *NEWNEWS*. In response, the server sends to the client a list of new newsgroups that have been created since the specified date/time.

NNTP Client-Server Communication Process: News Posting and Access

The propagation of Usenet articles is indeed a defining function of the Network News Transfer Protocol (NNTP)—would I lie to you? ☺ However, one critical area where NNTP differs from its progenitor, *SMTP*, is that NNTP is used not just for inter-server communication. It is also the protocol utilized for the initial posting of Usenet messages, and reading them as well. In fact, the majority of NNTP commands deal with the interaction between user client machines and NNTP servers, not communication between servers.

An NNTP client is any software program that knows the NNTP protocol and is designed to provide user access to Usenet. NNTP clients are usually called *newsreaders*, and provide two main capabilities to a user: *posting* (creating) and *reading* Usenet messages. Usenet newsreaders exist for virtually all hardware and software platforms, and range greatly in terms of capabilities, user interface and other characteristics. Most people today use a Usenet newsreader on a client computer that must make NNTP connections to a separate NNTP server to read and post news. These programs are analogous to e-mail clients, and in fact, many e-mail clients also function as NNTP clients.

News Posting

Posting a Usenet message is the first step in the overall Usenet communication process (although many Usenet articles are actually replies to other articles, so it's a bit of a “chicken and egg” thing.) Article posting is quite straight-forward with NNTP. The client establishes a connection to the server and issues the *POST* command. If the server is willing to accept new articles it replies with a prompt for the client to send it the article. The article is then transmitted by the client to the server. Some newsreaders may “batch” new articles so they can be sent in a single NNTP session rather than submitting them one at a time.

News Access and Article Reading

Newsreaders also establish an NNTP connection to a server to read Usenet articles. NNTP provides a large number of commands to support a variety of different article access and retrieval actions that may be taken by a user. The first step in reading is sometimes to examine the list of available newsgroups. Using the *LIST* command, the client requests from the server a list of the newsgroups available for reading and posting. RFC 977 defined

the basic *LIST* command, which returns a list of all groups to the client. RFC 2980 defines numerous extensions to the command to allow a client to retrieve only certain types of information about groups on the server. Since the number of Usenet newsgroups is so large today, many times this listing of newsgroups is now skipped unless the user specifically requests it.

The next step in Usenet message access is typically to select a newsgroup to read from the list of groups available. Again, since there are so many groups today, most newsreaders allow a user to search for a group name using a pattern or partial name string. The *GROUP* command is then sent to the server with the name of the selected group. The server returns the first and last current article numbers for the group to the client.

Messages are identified in two ways, one absolute and the other site-specific. The article's *Message ID* is a fixed identifier that can be used to uniquely represent it across Usenet; this is what is used in inter-server communication to determine whether or not each site has a copy of a given message. In contrast, *article numbers* are server-specific; they represent the numbers assigned to those articles as they arrived at that server and are used as a "short hand" to more easily refer to articles in a newsgroup. Thus, the same message will have a different article number on each NNTP server. They are used for convenience, since an article number is much shorter than a message ID. During a session, the NNTP server also maintains a "current article pointer" that can be used for stepping sequentially through a newsgroup.

News Access Methods

There are several different ways that the newsreader can access messages in a group, depending on how it is programmed and on what the user of the software wants.

Full Newsgroup Retrieval

This is the "brute force" technique: the client simply requests that the server send it all the messages in the group. This is done by issuing the *ARTICLE* command to select the first current message in the group, using the first article number returned by the *GROUP* command. This sets the server's internal pointer for the session to point to the first article, so it can be retrieved. The *NEXT* command is then used to advance the pointer to the next message, and the *ARTICLE* command to retrieve it. This continues until the entire group has been read. [Figure 313](#) illustrates the process.

The retrieved messages are stored by the newsreader and available for instant access by the user. This method is most suitable for relatively small newsgroups and/or users with fast Internet connections.

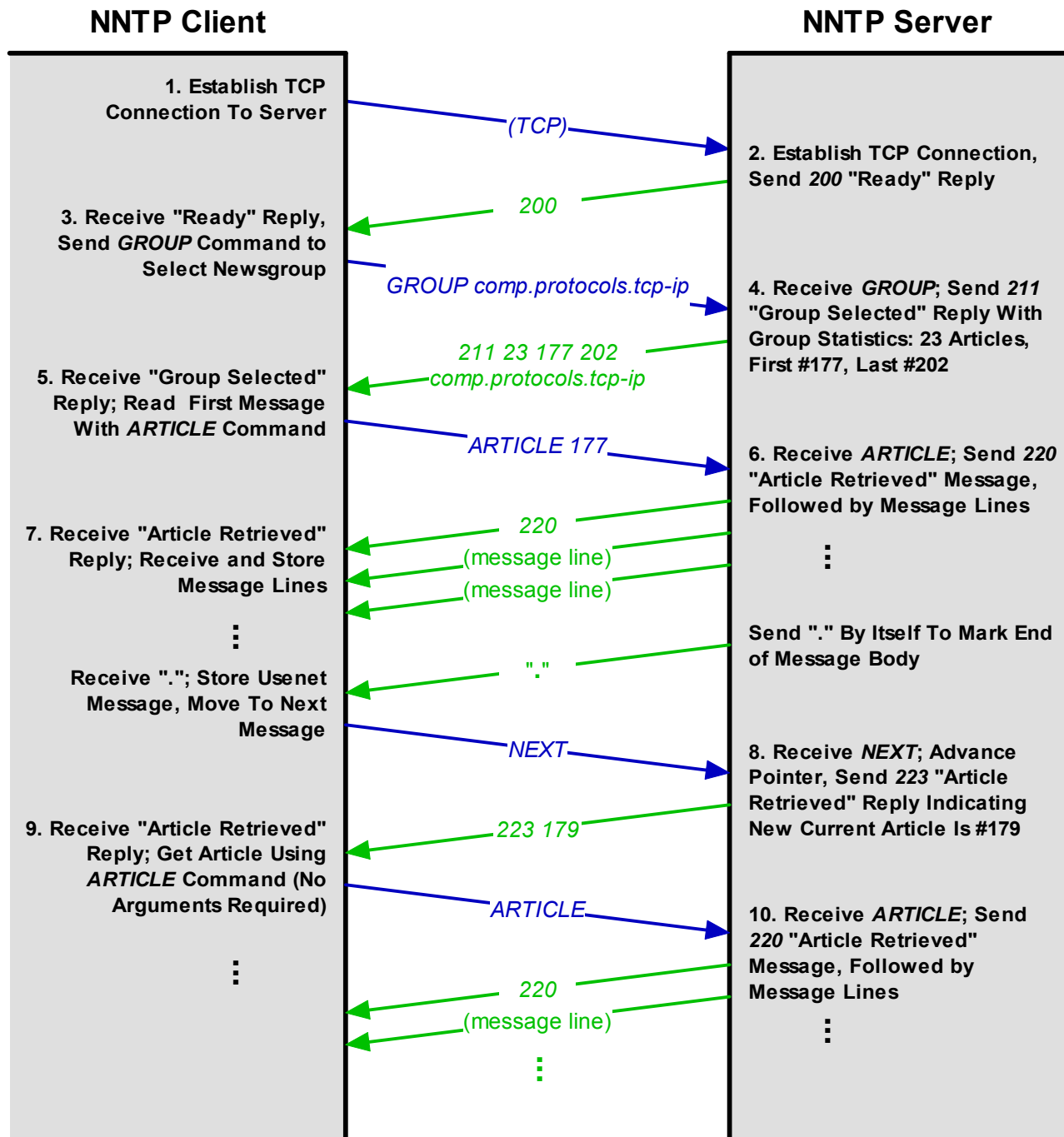

Figure 313: NNTP Full Newsgroup Retrieval Process

There are many ways that an NNTP client can access and read Usenet messages on a server. One common method is to retrieve the entire contents of a newsgroup. In this example, the client uses the *GROUP* command to select the newsgroup *comp.protocols.tcp-ip* for reading; the server responds with a 211 "group selected" reply, which includes important statistics about the group. The client uses the *ARTICLE* command with the number of the first article in the group, 177, to read it from the server. The server then sends the message line by line, ending it with a single period on a line. The client uses the *NEXT* command to tell the server to advance its internal article pointer to the next message, which often will *not* be the next consecutive number after the one just read; here it is 179. The client can then read that message by sending the *ARTICLE* command by itself; since no parameters are given the server returns the current message (#179).

Newsgroup Header Retrieval

Since downloading an entire newsgroup is time-consuming, many newsreaders compromise by downloading the headers of all messages instead of the full message. The process is the same as for full newsgroup retrieval, but the *HEAD* command is used to retrieve just an article's headers instead of the *ARTICLE* command. This takes less time than retrieving each message in its entirety.

The *XHDR* command extension can also be used, if the server supports it, to more efficiently retrieve only a subset of the headers for the messages, such as the subject line and author.

Individual Article Retrieval

It is also possible to retrieve a single message from a group, using the *ARTICLE* command and specifying the article's message identifier.



Key Concept: While NNTP is best known for its role in inter-server propagation, it is also used by Usenet clients to write and read articles. A number of different commands provides flexibility in how articles can be read by a client device. A client can retrieve an entire newsgroup, only a set of newsgroup headers, or individual articles. Other commands also support various administrative functions.

Other Client-Server Functions

In addition to reading and posting, NNTP includes commands to support other “miscellaneous” tasks that a Usenet user may wish to perform. The client can ask the server for help information using the *HELP* command, or get a list of new newsgroups using the *NEWGROUPS* command, as described in [the inter-server communication topic](#).

Most modern newsreaders include capabilities that go far beyond the basic posting and reading functions described above. Most maintain their own sets of configuration files that allow a user to maintain a set of favorite “subscribed” newsgroups, rather than having to choose a group to read from the master list each time Usenet is accessed. Newsreaders also keep track of which articles have been read by a user in each subscribed newsgroup, so one need not wade through a whole newsgroup to see new messages that have been posted.

Article Threading

One particularly useful enhancement to basic Usenet article reading is *threading*. This feature allows a newsreader to display articles not strictly in either alphabetical or chronological order, but rather grouped into conversations using the information in the articles' *References* headers. Threading is especially useful in busy newsgroups, as it allows you to see all the articles in a particular discussion at once, rather than trying to juggle messages from many conversations simultaneously.

A problem with threading is that it takes a long time for a newsreader to sift through all those *References* lines and construct the article threads. To speed up this process, many servers now cache extra threading or overview information for newsgroups, which can be retrieved by the client to save time when a newsgroup is opened. This is done using the *XTHREAD* or *XOVER NNTP command extensions*.

NNTP Commands

One of the great strengths of the [open, cooperative process](#) used to develop Internet standards, is that new protocols are usually designed by building upon successes in older ones. This both saves development time and effort, and promotes compatibility between technologies. As I explained in [the overview of NNTP](#), it was based in many ways on principles from [SMTP](#); SMTP in turn borrowed ideas from earlier protocols, [Telnet](#) and [FTP](#). This legacy can be seen in the similarities between NNTP commands and those of these earlier protocols.

Command Syntax

As in SMTP, all NNTP commands are ASCII text that are sent over the NNTP TCP connection to an NNTP server, from the device acting as the client (which may be a newsreader client or an NNTP server itself). These are standard text strings adhering to the [Telnet Network Virtual Terminal \(NVT\) format](#), terminated by the two-character “CRLF” sequence. As is the case with SMTP and FTP, you can conduct an interactive session with an NNTP server by using Telnet to connect to it on port 119.

The basic syntax of an NNTP command is as follows:

`<command-code> <parameters>`

Unlike SMTP, NNTP commands are not restricted to a length of four characters. The parameters that follow the command are separated by one or more space characters, and are used to provide necessary information to allow the server to execute the command. NNTP commands are not case-sensitive.

Base Command Set

The main NNTP specification, RFC 977, describes the base set of commands supported by NNTP clients and servers. They are not broken into categories but rather listed alphabetically, as I have done in [Table 267](#). Additional details on how most of these commands are used can be found in the topics on [news article propagation](#) and [news posting and access](#).

Table 267: NNTP Base Commands (Page 1 of 2)

Command Code	Command	Parameters	Description
ARTICLE	<i>Retrieve Article</i>	Message ID or server article number.	Tells the server to send the client a particular Usenet article. The article to be retrieved may be specified either using its absolute, universal message ID, or its locally-assigned article number. When the command is issued with an article number, this causes the server's internal message pointer to be set to the specified article. If the message pointer is already set to a particular article, the <i>ARTICLE</i> command can be issued without an article number and the current message will be retrieved.
HEAD	<i>Retrieve Article Headers</i>	Message ID or server article number.	Same as the <i>ARTICLE</i> command, but retrieves only the article's headers.
BODY	<i>Retrieve Article Body</i>	Message ID or server article number.	Same as the <i>ARTICLE</i> command, but returns only the body of the article.
STAT	<i>Retrieve Article Statistics</i>	Server article number	Conceptually the same as the <i>ARTICLE</i> command, but does not return any message text, only the message ID of the article. This command is usually used for the purpose of setting the server's internal message pointer, so <i>STAT</i> is normally invoked only with an article number (and not a message ID).
GROUP	<i>Select Newsgroup</i>	Newsgroup name	Tells the server the name of the newsgroup that the client wants to access. Assuming the group specified exists, the server returns to the client the numbers of the first and last articles currently in the group, along with an estimate of the number of messages in the group. The server's internal article pointer is also set to the first message in the group.
HELP	<i>Get Help Information</i>	None	Prompts the server to send the client help information, which usually takes the form of a list of valid commands that the server supports.
IHAVE	<i>Offer Article To Server</i>	Message ID	Used by the client in an NNTP session to tell the server that it has a new article that the server may want. The server will check the message ID provided and respond to the client indicating whether or not it wants the client to send the article.

Table 267: NNTP Base Commands (Page 2 of 2)

Command Code	Command	Parameters	Description
LAST	<i>Go To Last Message</i>	None	Tells the server to set its current article pointer to the last message in the newsgroup.
LIST	<i>List Newsgroups</i>	None	Asks the server to send a list of the newsgroups that it supports, along with the first and last article number in each group. The command as described in RFC 977 is simple, supporting no parameters and causing the full list of newsgroups to be sent to the client. NNTP command extensions significantly expand the syntax of this command.
NEWGROUPS	<i>List New Newsgroups</i>	Date and time, and optional distribution specification	Prompts the server to send a list of new newsgroups created since the date and time specified. The client may also restrict the command to return only new newsgroups within a particular regional distribution.
NEWNEWS	<i>List New News Articles</i>	Date and time, and optional distribution specification	Requests a list from the server of all new articles that have arrived since a particular date and time. Like the NEWGROUPS command, this may be restricted in distribution. The server responds with a list of message IDs of new articles.
NEXT	<i>Go To Next Message</i>	None	Advances the server's current article pointer to the next message in the newsgroup.
POST	<i>Post Article</i>	None	Tells the server that the client would like to post a new article. The server responds with either a positive or negative acknowledgment. Assuming that posting is allowed, the client then sends the full text of the message to the server, which stores it and begins the process of propagating it to other servers.
QUIT	<i>End Session</i>	None	Terminates the NNTP session. To be "polite", the client should issue this command prior to closing the TCP connection.
SLAVE	<i>Set Slave Status</i>	None	This command is intended for use in special configurations where one NNTP server acts as a subsidiary to others. It is not often used in practice.

RFC 2980 defines a number of extensions that both add new commands to this set and make changes to one of these commands (*LIST*). NNTP extensions are described in the next topic.



Key Concept: The main NNTP standard defines a number of base *NNTP commands* that are used by the device initiating an NNTP connection to accomplish article propagation, posting or reading functions. NNTP commands consist of a command code and optionally, parameters that specify how the command is to be carried out.

NNTP Command Extensions

The [base command set](#) described in RFC 977 was sufficient to enable client-server and inter-server functionality, but was in many ways quite basic and limited in efficiency and usefulness. As Usenet grew larger and more popular in the late 1980s, demand grew for changes to improve the usability of NNTP. In 1991, work began on a formal revision to the NNTP standard, but was never completed. Despite this, many of the concepts from that effort were adopted “informally” in NNTP implementations in subsequent years. In addition, some Usenet software authors created their own non-standard features to improve the protocol. Some of these themselves became [de facto standards](#) through widespread adoption.

As a result, by the late 1990s, most Usenet software actually implemented variations of NNTP with capabilities far exceeding what was documented in the standard. Naturally, not all NNTP software supported the same “extra” features, leading to potential compatibility difficulties between servers and clients. RFC 2980, [Common NNTP Extensions](#), was published in October 2000 to formalize many of these extensions to the base NNTP standard as defined in RFC 977.

The NNTP extensions primarily consist of new NNTP commands that are added to the basic NNTP command set, as well as some minor changes to how other commands and functions of NNTP work. The extensions generally fall into three categories: those that improve the efficiency of NNTP [message transport between servers](#); those that make NNTP more effective for [client message access](#), and “miscellaneous” ones that don't fall into either of those two groups.

NNTP Transport Extensions

The first group is called the NNTP *transport extensions* and consists of a small group of related commands that are designed to improve inter-server message propagation. Most of these implement NNTP's *stream mode*, which provides a more effective way of moving large numbers of articles from one server to another, as described in [the topic on inter-server communication](#). [Table 268](#) describes the new transport commands.

Table 268: NNTP Transport Extensions (Page 1 of 2)

Command Code	Command	Parameters	Description
<i>MODE STREAM</i>	<i>Set Stream Mode</i>	None	Used to tell the server that the client wants to operate in stream mode, using the <i>CHECK</i> and <i>TAKETHIS</i> commands.
<i>CHECK</i>	<i>Check If Article Exists</i>	Message ID	Used in stream mode by a server acting as a client to ask another server if it has a copy of a particular article. The server responds back indicating whether or not it wishes to be sent a copy of the article. This command is similar to <i>IHAVE</i> , except that the client does not have to wait for a reply before sending the next command.

Table 268: NNTP Transport Extensions (Page 2 of 2)

Command Code	Command	Parameters	Description
TAKETHIS	<i>Send Article To Server</i>	Message ID	When a server responds to a <i>CHECK</i> command indicating that it wants a copy of a particular message, the client sends it using this command.
XREPLIC	<i>Replicate Articles</i>	List of newsgroups and article numbers	This command was created for the special purpose of copying large numbers of articles from one server to another. It is not widely used.

NNTP Newsreader Extensions

The second group of extensions defined by RFC 2980 are the *newsreader extensions*, which focus primarily on commands used by newsreader clients in interactions with NNTP servers. These extensions consist of several new commands as well as significant enhancements to one important command that was very limited in its functionality in RFC 977: *LIST*.

The original *LIST* command has no parameters and only allows a client to retrieve the entire list of newsgroups a server carries. This may have been sufficient when there were only a few hundred Usenet newsgroups, but there are now tens of thousands. RFC 2980 defines a number of new variations of the *LIST* command, to allow the client much more flexibility in the types of information the server returns. [Table 269](#) shows the new *LIST* command variations.

Table 269: NNTP LIST Command Extensions (Page 1 of 2)

Command Code	Command	Parameters	Description
LIST ACTIVE	<i>List Active Newsgroups</i>	Newsgroup name or pattern	Provides a list of active newsgroups on the server. This is semantically the same as the original <i>LIST</i> command, but the client may provide a newsgroup name or a pattern to restrict the number of newsgroups returned. For example, the client can ask for a list of only the newsgroups that contain "football" in them.
LIST ACTIVE.TIMES	<i>List Active Newsgroup Creation Times</i>	None	Prompts the server to send the client its <i>active.times</i> file, which contains information about when the newsgroups carried by the server were created.
LIST DISTRIBUTIONS	<i>List Distributions</i>	None	Causes the server to send the client the contents of the <i>distributions</i> file, which shows what regional distribution strings the server recognizes (for use in the <i>Distribution</i> header of a message).

Table 269: NNTP LIST Command Extensions (Page 2 of 2)

Command Code	Command	Parameters	Description
LIST DISTRIB.PATS	<i>List Distribution Patterns</i>	None	Asks the server for its <i>distribution.pats</i> file, which is like the <i>distributions</i> file but uses patterns to summarize distribution information for different newsgroups.
LIST NEWSGROUPS	<i>List Newsgroups</i>	Newsgroup name or pattern	Provides a list of newsgroup names and descriptions. This differs from <i>LIST ACTIVE</i> in that only the newsgroup name and description are returned, and not the article numbers for each newsgroup. It is functionally the same as <i>XGTITLE</i> (see Table 270) and is usually employed by a user to locate a newsgroup to be added to his or her subscribed list.
LIST OVERVIEW.FMT	<i>Display Overview Format</i>	None	Prompts the server to display information about the format of its <i>overview</i> file. See the <i>XOVER</i> command description below for more.
LIST SUBSCRIPTIONS	<i>Retrieve Default Subscription List</i>	None	Asks the server to send the client a default list of subscribed newsgroups. This is used to set up a new user with a suggested list of newsgroups. For example, if an organization has an internal support newsgroup, they could put this group on the default subscription list so all new users learn about it immediately when they first start up their newsreader.

In addition to these changes to the *LIST* command, many new newsreader-related command extensions are defined, which are described in [Table 270](#).

Table 270: NNTP Newsreader Extensions (Page 1 of 2)

Command Code	Command	Parameters	Description
LISTGROUP	<i>List Article Numbers In Newsgroup</i>	Newsgroup name	Causes the server to return a list of local article numbers for the current messages in the newsgroup. The server's current article pointer is also set to the first message in the group.
MODE READER	<i>Set Newsreader Mode</i>	None	Tells the server that the device acting as a client is in fact a client newsreader and not another NNTP server. While technically not required—all commands can be sent by any device acting as client—some servers may be optimized to respond to newsreader-oriented commands if given this command.
XGTITLE	<i>Retrieve Newsgroup Descriptions</i>	Newsgroup name or pattern	Used to list the descriptions for a newsgroup or a set of newsgroups matching a particular text pattern. This command is functionally the same as the <i>LIST NEWSGROUP</i> command extension (see Table 269). It is therefore recommended that <i>XGTITLE</i> no longer be used.

Table 270: NNTP Newsreader Extensions (Page 2 of 2)

Command Code	Command	Parameters	Description
XHDR	<i>Retrieve Article Headers</i>	Header name and optionally, either a message ID or a range of article numbers	<p>Allows a client to ask for only a particular header from a set of messages. If only the header name is provided, the header is returned for all messages in the current group. Otherwise, the header is provided for the selected messages.</p> <p>This extension provides a newsreader client with a more efficient way of retrieving and displaying important headers in a newsgroup to a user.</p>
XINDEX	<i>Retrieve Index Information</i>	Newsgroup name	Retrieves an <i>index</i> file, used by the newsreader <i>TIN</i> to improve the efficiency of newsgroup perusal. <i>TIN</i> now supports the more common “overview” format, so the <i>XOVER</i> command is preferred to this one.
XOVER	<i>Retrieve Overview Information</i>	Article number or range of article numbers in a newsgroup	Retrieves the <i>overview</i> for an article or set of articles. Servers supporting this feature maintain a special database for their newsgroups that contains information about current articles in a format that can be used by a variety of newsreaders. Retrieving the overview information allows features like message threading to be performed more quickly than if the client had to retrieve the headers of each message and analyze them manually.
XPAT	<i>Retrieve Article Headers Matching A Pattern</i>	Header name, pattern, and either a message ID or a range of article numbers	This command is similar to <i>XHDR</i> in that it allows a particular header to be retrieved for a set of messages. The difference is that the client can specify a pattern that must be matched for the header to be retrieved. This allows the client to have the server search for and return certain messages, such as those with a subject line indicating a particular type of discussion, rather than requiring the client to download all the headers and search through them.
XPATH	<i>Retrieve Filename Information</i>	Message ID	Allows a client to ask for the name of the actual file in which a particular message is stored on the server.
XROVER	<i>Retrieve Overview Reference Information</i>	Article number or range of article numbers in a newsgroup	Like the <i>XOVER</i> command, but specifically retrieves information in the <i>References</i> header for the indicated articles. This is, of course, the header containing the data needed to create threaded conversations.
XTHREAD	<i>Retrieve Threading Information</i>	Optional “DBINIT” parameter	<p>Similar to <i>XINDEX</i>, but retrieves a special threading information file in the format used by the newsreader <i>TRN</i>. Like <i>TIN</i>, <i>TRN</i> now supports the common “overview” format so <i>XOVER</i> is preferred to this command.</p> <p>The “DBINIT” parameter can be used to check for the existence of a thread database.</p>

Other NNTP Extensions

The last extension group is the “other” extensions, miscellaneous ones not strictly related to either inter-server or client-server NNTP interaction. There are two commands in this group: *AUTHINFO* and *DATE*. The latter is a simple command that causes the server to tell the client its current date and time. *AUTHINFO* is more interesting: it is used by a client to provide authentication data to a server.

You may have noticed that there are no commands related to security described in the RFC 977 protocol. That's because the original NNTP had no security features whatsoever. Like many protocols written before the modern Internet era, security was not considered a big issue back in the early 1980s. Most news servers were used only by people within the organization owning the server, and simple security measures were used, such as restricting access to servers by IP address or through the use of access lists.

One of the more important changes made by many NNTP software implementation as soon as Usenet grew in size was to require authentication. Modern clients will usually issue *AUTHINFO* as one of its first commands upon establishing a connection to a server, because the server will refuse to accept most other commands before this is done. A special reply code is also added to NNTP for a server to use if it rejects a command due to improper authentication.

The *AUTHINFO* command can be invoked in several different ways. The original version of the command required the client to issue an *AUTHINFO USER* command with a user name, followed by *AUTHINFO PASS* with a password. Naturally, this is simple user/password login authentication. A variation of this is the *AUTHINFO SIMPLE* command, where the client needs to send just a password.

A client and server can also agree to use more sophisticated authentication methods by making use of the *AUTHINFO GENERIC* command. The client provides to the server the name of the authentication method it wants to use, along with any arguments required for authentication. The client and server then exchange messages and authentication information as required by the particular authenticator they are using.



Key Concept: A number of limitations in its base command set led to a proliferation of non-standard enhancements to NNTP during the 1980s and 1990s. These were eventually documented in a set of NNTP *command extensions* that formally supplement the original RFC 977 commands. The extensions are conceptually divided into three groups: *transport extensions* that refine how NNTP propagates messages; *newsreader extensions* that improve client article access; and miscellaneous extensions, of which the most important is the *AUTHINFO* extension that adds security to NNTP.

NNTP Status Responses and Response Codes

Each time the device acting as a client in an NNTP connection sends a command, the server sends back a *response*. The response serves to acknowledge receipt of the command, to inform the client of the results of processing the command, and possibly to prompt for additional information. Since NNTP commands are structured and formatted in a way very similar to that of SMTP commands, I'm sure it will come as no great surprise that NNTP responses are likewise very similar to [those of SMTP](#). In turn, SMTP responses are based on [the system designed for replies in FTP](#).

The first line of an NNTP response consists of a three-digit numerical *response code*, as well as a line of descriptive text that summarizes the response. These response codes are structured so that each digit has a particular significance, which allows the client to quickly determine the status of the command to which the reply was sent. After the initial response line, depending on the reply, a number of additional response lines may follow. For example, a successful *LIST* command results in a 215 response code, followed by a list of newsgroups.



Background Information: [The topic on FTP reply codes](#) discusses more completely the reasons why numeric reply codes are used in addition to descriptive text.

Reply Code Structure and Digit Interpretation

As with SMTP and FTP, NNTP reply codes can be considered to be of the form “xyz”, where “x” is the first digit, “y” the second and “z” the third.

First Reply Code Digit (“x”)

The first digit indicates the success, failure or progress of the command in general terms, whether a successful command is complete or incomplete, and the general reason why an unsuccessful command did not work. The values of this digit are defined slightly differently than in SMTP and FTP. In some cases, the terminology is just simplified; for example, the second category is “Command OK” instead of “Positive Completion Reply”. [Table 271](#) shows the specific meaning of the possible values of this digit.

Table 271: NNTP Reply Code Format: First Digit Interpretation (Page 1 of 2)

Reply Code Format	Meaning	Description
1yz	Informative Message	General information; used for help information and debugging.
2yz	Command OK	The command was completed successfully.

Table 271: NNTP Reply Code Format: First Digit Interpretation (Page 2 of 2)

Reply Code Format	Meaning	Description
3yz	Command OK So Far, Send The Rest	An intermediate reply, sent to prompt the client to send more information. Typically used for replies to commands such as <i>IHAVE</i> or <i>POST</i> , where the server acknowledges the command and then requests that an article be transmitted by the client.
4yz	Command Was Correct, But Couldn't Be Performed	The command was valid but could not be performed. This type of error usually occurs due to bad parameters, a transient problem with the server, bad command sequence or similar situations.
5yz	Command Unimplemented Or Incorrect, Or Serious Program Error	The command was invalid or a significant program error prevented it from being performed.

Second Reply Code Digit (“y”)

The second digit categorizes messages into functional groups. This digit is used in the same general way as in SMTP and FTP, but the functional groups are different; they are described in [Table 272](#).

Table 272: NNTP Reply Code Format: Second Digit Interpretation

Reply Code Format	Meaning	Description
x0z	Connection, Setup and Miscellaneous	Generic and miscellaneous replies.
x1z	Newsgroup Selection	Messages related to commands used to select a newsgroup.
x2z	Article Selection	Messages related to commands used to select an article.
x3z	Distribution Functions	Messages related to the transfer of messages.
x4z	Posting	Messages related to posting messages.
x5z	Authentication	Messages related to authentication and the <i>AUTHINFO</i> command extension. (This category is not officially listed in the standard, but these responses have a middle digit of “5”).
x8z	Nonstandard Extensions	Reserved for private, non-standard implementation use.
x9z	Debugging	Debugging output messages.

Third Reply Code Digit (“z”)

This last digit indicates a specific type of message within each of the functional groups described by the second digit. The third digit allows each functional group to have 10 different reply codes for each reply type given by the first code digit.

Combining Digit Values to Make Specific Reply Codes

As in FTP and SMTP, these “x”, “y” and “z” digit meanings are combined to make specific reply codes. For example, the reply code “435” is sent by the server if a client issues the *IHAVE* command but the server doesn't want the article being offered. The command was correct but the reply is negative, thus it starts with “4”, and the message is related to message distribution, so the middle digit is “3”.

Common NNTP Reply Codes

Table 273 contains a list of some of the more common NNTP reply codes in numerical order, along with typical reply text from the standard, and additional descriptive information.

Table 273: NNTP Reply Codes (Page 1 of 3)

Reply Code	Reply Text	Description
100	help text follows	Precedes response to <i>HELP</i> command.
111	(date and time)	Response to <i>DATE</i> command extension.
199	(debugging output)	Debugging information.
200	server ready - posting allowed	Sent by the server upon initiation of the session, if the client is allowed to post messages.
201	server ready - no posting allowed	Sent by the server upon initiation of the session, if the client is not allowed to post messages.
202	slave status noted	Response to the <i>SLAVE</i> command.
203	streaming is ok	Successful response to <i>MODE STREAM</i> command.
205	closing connection - goodbye!	Goodbye message sent in response to a <i>QUIT</i> message.
211	n f l s group selected	Successful response to the <i>GROUP</i> command, indicating the estimated number of messages in the group (“n”), first and last article numbers (“f” and “l”) and group name (“s”).
215	list of newsgroups follows (OR) information follows	Successful response to <i>LIST</i> command. The second form is for variations of <i>LIST</i> defined as NNTP command extensions .
218	tin-style index follows	Successful response to <i>XINDEX</i> command extension.
220	n <a> article retrieved - head and body follow	Successful response to the <i>ARTICLE</i> command, indicating the article number and message ID of the article.
221	n <a> article retrieved - head follows	Successful response to the <i>HEAD</i> command, indicating the article number and message ID of the article.
222	n <a> article retrieved - body follows	Successful response to the <i>BODY</i> command, indicating the article number and message ID of the article.
223	n <a> article retrieved - request text separately	Successful response to the <i>STAT</i> command, indicating the article number and message ID of the article.
224	overview information follows	Successful response to the <i>XOVER</i> command extension.

Table 273: NNTP Reply Codes (Page 2 of 3)

Reply Code	Reply Text	Description
230	list of new articles by message-id follows	Successful response to the <i>NEWNEWS</i> command.
235	article transferred ok	Successful response to the <i>IHAVE</i> command, after article has been sent.
239	article transferred ok	Successful response to the <i>TAKETHIS</i> command.
240	article posted ok	Successful response to the <i>POST</i> command, after article has been posted.
250 or 281	authentication accepted	Successful authentication using the <i>AUTHINFO</i> command extension.
282	list of groups and descriptions follows	Positive response to the <i>XGTITLE</i> command extension.
288	binary data to follow	Successful response to the <i>XTHREAD</i> command extension.
335	send article to be transferred	Preliminary response to the <i>IHAVE</i> command.
340	send article to be posted	Preliminary response to the <i>POST</i> command.
381	more authentication information required	Preliminary response to the <i>AUTHINFO</i> command extension.
400	service discontinued	Session is being terminated, perhaps due to user request.
411	no such newsgroup	Invalid newsgroup name specified.
412	no newsgroup has been selected	Attempt to issue a command that refers to the current newsgroup before one has been selected using <i>GROUP</i> .
420	no current article has been selected	Attempt to issue a command that refers to the current article using the server's current article pointer, before the pointer has been set through article selection.
421	no next article in this group	Response to <i>NEXT</i> command when at last article of a newsgroup.
422	no previous article in this group	Possible response to <i>LAST</i> ; I have no idea why the word "previous" is in there.
423	no such article number in this group	Command with invalid article number.
430	no such article found	Article not found; it may have been deleted.
435	article not wanted - do not send it	Negative response to <i>IHAVE</i> if server doesn't need the article.
436	transfer failed - try again later	Temporary failure of article transfer, retry.
437	article rejected - do not try again	Article refused for whatever reason.
438	already have it, please don't send it to me	Same as reply code 435, but for the <i>CHECK</i> command extension.
440	posting not allowed	<i>POST</i> command issued when posting is not allowed.

Table 273: NNTP Reply Codes (Page 3 of 3)

Reply Code	Reply Text	Description
441	posting failed	<i>POST</i> command failed.
450	authorization required for this command	Response sent when server requires authentication but client has not yet authenticated.
452	authorization rejected	Failed authentication.
480	transfer permission denied	Response to <i>CHECK</i> if transfer is not allowed.
500	command not recognized	Bad command.
501	command syntax error	Bad syntax in command.
502	access restriction or permission denied	Permission denied; sent if the client has not properly authentication but the server requires it.
503	program fault - command not performed	General fatal error message.



Key Concept: Each command sent by the device acting as the client in an NNTP connection results in the server returning a *reply*. NNTP replies consist of a three-digit reply code and a string of descriptive text; they are modelled after those of SMTP, and in turn, FTP.



TCP/IP World Wide Web (WWW, "The Web") and the Hypertext Transfer Protocol (HTTP)

So finally, we come to the Big Kahuna. ☺ In my [overview of file and message transfer protocols](#), I said that the World Wide Web was “almost certainly” the most important TCP/IP application. If anything, I was probably understating the case. The Web is not only quite clearly the most important TCP/IP application today, it is arguably the single most important application in the history of networking, and perhaps even computing as a whole.

Does this sound a little melodramatic? More than a little? Perhaps, but consider what the Web has done in the decade or so that it has been around. It has transformed not only how internetworks are used, but in many ways, has changed society itself. The Web put the Internet “on the map”, so to speak, moving it from the realm of technicians and academics and making it a big part of the mainstream world.

In this section I describe the World Wide Web in two subsections. The first discusses the Web and the concepts behind hypertext and hypertext documents in general terms. The second explains the operation of the all-important *Hypertext Transfer Protocol (HTTP)*, the TCP/IP application layer protocol that makes the Web work.



Note: As I've said in many other section headers, I simply cannot do complete justice here to a topic as large as the World Wide Web. There have not only been whole books written about the Web, there are **shelves** full of such books. Due to the already large size of this Guide, and its overall focus on how protocols and technologies work, I must contain my enthusiasm and limit my scope to providing an overview of what the Web is all about, while focusing on the nuts and bolts of HTTP itself.

TCP/IP World Wide Web and Hypertext Overview and Concepts

The World Wide Web expands the concepts of messaging beyond the limits of simple text file transfer of [e-mail](#), [FTP](#) and [Usenet](#). Its power is in its combination of *hypertext*, a system that allows related documents to be linked together, its rich document format that supports not just text but graphics and multimedia, and the special protocol that allows efficient movement of those media. The result is a powerful system that once introduced, caught on almost immediately amongst everyone from large companies to individuals, and in a few short years came to dominate all other applications on the Internet.

In this section, I take a high-level, summarized look at the concepts behind the World Wide Web. I begin with a short overview and history of the Web and hypertext, and a discussion of the components that comprise the Web system. I briefly describe the documents and media used on the Web and explain the importance of the Hypertext Markup Language (HTML). I conclude with an overview of how documents are addressed on the Web using Uniform Resource Locators (URLs).

World Wide Web and Hypertext Overview and History

At one point, I considered putting my section on the Web in a distinct location, separate from the discussion of other file and message transfer protocols. It didn't "seem" at first like a message transfer protocol to me. But I realized that, boiled down, the Web really *is* just another way of storing information and then transferring it from one computer to another. A question immediately struck me: if this is the case, what was so special about the Web that caused it to become popular in a way that no prior messaging applications ever had?

There is no simple one-word answer to this question. However, if I had to give one anyway, it would be this: *hypertext*. Sure, applications like e-mail and Usenet allow users to send and receive information, and FTP lets a user access a set of files on a server. But what these methods lack is any way of easily representing the *relationship* between documents or providing a way of moving from one to another. Highly simplified, hypertext does exactly that: it allows the creator of a document to include links to related information either elsewhere in that document or in others. With the appropriate software, a user can easily move from one location to another.

Big deal? In fact, this is more important than it may initially seem. Without some way of linking documents together, they remain in unconnected "islands". In some ways, hypertext-linked documents are to unlinked documents what networked computers are to those that are not networked. Consider the difference between this Guide and a hard-copy book; if I mention a topic in passing I can provide a link to it; a printed book cannot. Hopefully you've already discovered the advantages that this offers. ☺

History of Hypertext

The ideas behind hypertext actually go back far beyond the Web and even electronic computers. Vannevar Bush (1890-1974) is generally credited with introducing the idea in his 1945 description of a theoretical device called the *Memex*, which was intended to be used to store and retrieve documents. He described the concept of a **trail** that would link together related information to make it easier to organize and access the information in the device.

Bush's ideas were used as the basis of the work of several researchers who followed. One of these was Ted Nelson, who coined the term “hypertext” and in 1960, first described a system called *Xanadu*, which is considered one of the original hypertext software models.

The history of the World Wide Web itself goes back to 1989 at *CERN*, the European Organization for Nuclear Research, in Geneva. (The acronym stands for *Conseil Européene pour la Recherche Nucléaire*, the French name of the organization.) Many of the projects undertaken at CERN were large, complex, and took many years to complete. They also involved many scientists who had to work with and share related documents.

Development and Growth of the Web

A researcher at CERN, Tim Berners-Lee, proposed the idea of creating a “web” of electronically-linked documents. The rapidly-growing Internet was the obvious conduit for this project. He designed the first (very crude and simple) version of the [Hypertext Transfer Protocol \(HTTP\)](#) for TCP/IP in 1990. He was also responsible for developing or co-developing several of the other key concepts and components behind the Web, such as [Uniform Resource Identifiers \(URIs\)](#) and the [Hypertext Markup Language \(HTML\)](#).

The ability to link documents and files together had tremendous appeal, and it took little time before creative individuals found many different uses for this new technology. The early 1990s saw a flurry of development activity. Web server and client software was developed and refined, and the first graphical Web browser, *Mosaic*, was created by the National Center for Supercomputer Applications (NCSA) in 1993. (The developer of this program, Marc Andreessen, eventually formed Netscape Communications.)

Once the Web started to form, it grew very quickly indeed. In fact, to call the growth of the Web anything but “explosive” would not do it justice. In early 1993, there were only 50 active HTTP Web servers. By late 1993, there were over 1,000. By late 1995, thousands of new Web sites were coming online every day, and HTTP requests and responses had overtaken all other TCP/IP application traffic. By the end of the decade there were *millions* of Web sites and over a billion documents available on the Web.

The World Wide Web Today

While the rapid growth in the size of the Web is amazing, what is even more fascinating is its growth in **scope**. Since you are reading a Guide about networking, you are most likely a Web user, and familiar with the incredible array of different types of information you can find on the WWW today. Early hypertext systems were based on the use of only text

documents; today the Web is a world of many media including pictures, sounds and movies. The term *hypertext* has in many contexts been replaced with the more generic *hypermedia*—functionally, if not officially.

The Web has also moved beyond simple document retrieval to providing a myriad of services. A Web site can serve much more than just documents, allowing users to run thousands of kinds of programs. This enables everything from online shopping to entertainment. Web sites are also blurring the lines between different types of applications, offering [Web-based e-mail](#), Web-based Usenet access, bulletin boards and other interactive forums for discussion, and much more.

The Web has had an impact on both networking and society as a whole that even its most enthusiastic early fans could never have anticipated. In fact, the Web was the ultimate “killer application” for the Internet as a whole. In the early 1990s, big corporations viewed the Web as an amusing curiosity; by the end of the decade it was for many a business necessity. Millions of individuals and families discovered the wealth of information that was at their fingertips, and Internet access became for many another “utility”, like telephone service. In fact, the huge increase in Web traffic volume spawned the spending of billions of dollars on Internet infrastructure.

The “dot-com collapse” of the early 21st century took some of the wind out of the Web's sails. The incredible growth of the Web could not continue at its original pace, and has slowed somewhat. But the Web as a whole continues to expand and mature, and will likely be the most important information and service resource on the Internet for some time to come.



Key Concept: The *World Wide Web (WWW)* began in 1989 as a project designed to facilitate the representation of relationships between documents and the sharing of information between researchers. The main feature of the Web that makes it so powerful is *hypertext*, which allows links to be made from one document to another. The many benefits of the Web caused it to grow in only a few short years from a small application to the largest and arguably most important application in the world of networking; it is largely responsible for bringing the Internet into the mainstream of society.

World Wide Web System Concepts and Components

[Hypertext](#) is the main concept that makes the World Wide Web more than just another message transfer system. However, the idea behind hypertext had been around for decades before the Web was born, as had certain software products based on that idea. Obviously, more than just a concept is needed for an idea to be developed into a successful system.

The Web became a phenomenon because it combined the basic idea of hypertext with several other concepts and technologies, to create a rich, comprehensive mechanism for interactive communication. This system today encompasses so many different concepts

and software elements, and is so integrated with other technologies, that it's hard to find any two people who agree on what exactly comprises the Web, and which are most critical parts.

For example, one of the keys to the success of the World Wide Web is undeniably the combination of the [TCP/IP internetworking protocol suite](#) and the Internet infrastructure that connects together the computers of the world. Is the Internet then an essential component of the World Wide Web? In many ways it is; and in fact, due to how popular the Web is today, it is common to hear people call the Web “the Internet”.

The functional components of the World Wide Web are illustrated in [Figure 314](#). Let's take a look at them in a bit more detail now.

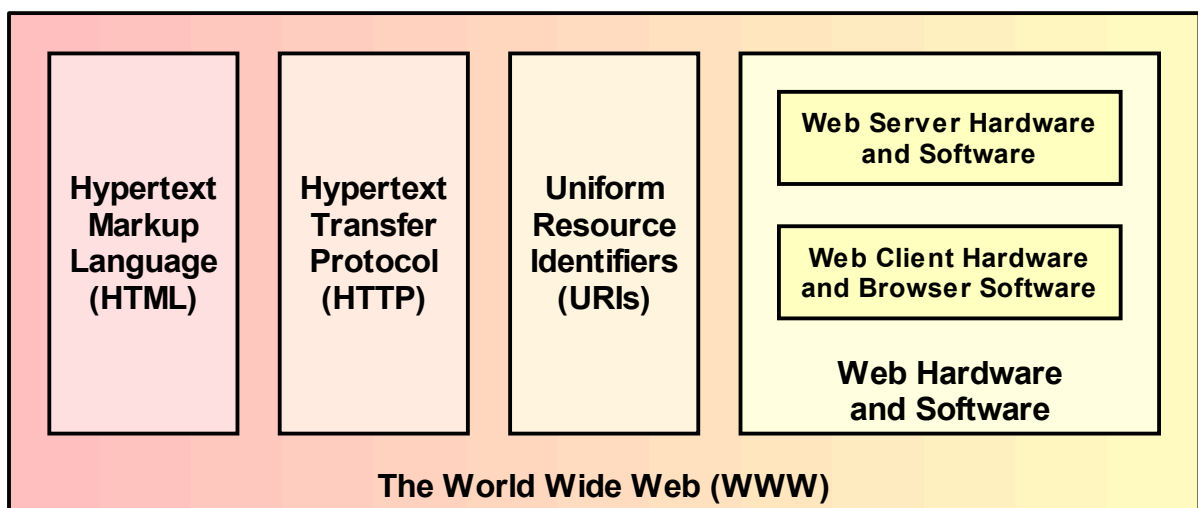

Figure 314: Major Functional Components of the World Wide Web

Major Functional Components of the Web

We know that equating the Web to the entire Internet is not a precise use of terms, but it shows how important the Web is and how closely it is tied to the Internet. Still, while the Internet and TCP/IP are obviously important parts of the Web's success, they are generic in nature. When it comes to defining the World Wide Web system itself more specifically, three particular components are usually considered most essential:

- ☉ **HyperText Markup Language (HTML):** A text language used to define hypertext documents. The idea behind HTML was to add simple constructs, called *tags*, to regular text documents, to enable the linking of one document to another, as well as to allow special data formatting and the combining of different types of media. HTML has become the standard language for implementing information in hypertext, and has spawned the creation of numerous other related languages.

-
- ☉ **Hypertext Transfer Protocol (HTTP):** The TCP/IP application-layer protocol that implements the World Wide Web, by enabling the transfer of hypertext documents and other files between a client and server. HTTP began as a very crude protocol for transferring HTML documents between computers, and has evolved to a full-featured and sophisticated messaging protocol. It supports transfers of many different kinds of documents, streaming of multiple files on a connection, and various advanced features including caching, proxying and authentication.
 - ☉ **Uniform Resource Identifiers (URIs):** A method of defining labels that identify resources on an internet so that they can be easily found and referenced. URIs were originally developed to provide a means by which the users of the Web could locate hypertext documents so they could be retrieved. URIs are actually not specific to the Web, though they are most often associated with the Web and HTTP.



Note: [Uniform Resource Locators \(URLs\)](#) are a subset of [Uniform Resource Identifiers \(URIs\)](#). The terms are often used interchangeably in World Wide Web discussions.

All three of these were created and developed at around the same time, and taken together represent the key technologies that define the World Wide Web. The next two topics in this section describe [HTML](#) and [the use of URIs](#) in the context of the World Wide Web. HTTP is really the heart of the Web and is covered extensively in [its own section](#) later in this Guide.

Web Hardware and Software

These three main components are supplemented by a number of other elements that play “supporting roles” in rounding out the system as a whole. Chief among these are the hardware and software used to implement client/server communication that makes the Web work: *Web servers* and *Web browsers*.

Web servers are computers that run special server software to allow them to provide hypertext documents and other files to clients who request them. Millions of such machines around the world now serve as a virtual, distributed repository of the enormous wealth of information that the Web represents.

Web browsers are HTTP client software programs that run on TCP/IP client computers to access Web documents on Web servers. These browser programs retrieve hypertext documents and display them, and also implement many of the Web's advanced features, such as caching. Today's browsers support a wide variety of media, allowing the Web to implement many different functions aside from simply hypertext document transfer. Examples include displaying images, playing sounds and implementing interactive programs.

Last but certainly not least, it is the **users** of the Web that are perhaps its most important component. This is sort of “cheating”, as this is in some ways like defining the Internet as being part of the Web. At the same time, I feel that user involvement has had more of a role in shaping the development of Web technology than any other networking application. The

Web began as a simple means of exchanging documents; today it has grown to encompass thousands of different applications and services, largely as a result of the creativity of users. Content providers have pushed the boundaries of what the Web can do by creating new ideas for information and services, to satisfy the insatiable demands of the end user community.



Key Concept: The World Wide Web is a complete system that is comprised of a number of related components, of which three are most essential. The first is *Hypertext Markup Language (HTML)*, which describes how hypertext documents are constructed; HTML is what allows links between documents to be represented. The second is the *Hypertext Transfer Protocol (HTTP)*, the application layer protocol that moves hypertext and other documents over the Web. The third is the *Uniform Resource Identifier (URI)* mechanism, which provides a consistent means of identifying resources, both on the Web and more generally on the Internet as a whole.

World Wide Web Media and the Hypertext Markup Language (HTML)

We've seen in the last two topics that the World Wide Web is based around the central concept of *hypertext*. The prefix “hyper” usually means “above” or “beyond”, and thus hypertext is like text, but goes beyond it in terms of functionality. Documents written in hypertext are similar to regular text files, but include information that implements hypertext functions. These are, of course, usually called *hypertext documents* or *hypertext files*.

The extra information in a hypertext document is used to tell the computer program that displays the file to a user how to format it. This information takes the form of special instructions that are interspersed with the actual text of the document itself, which are written according to the syntax of a defining language. This addition of extra elements to the content of a document is commonly called *marking up* the document.

Overview of HTML

The standard language used by the World Wide Web is thus called the *Hypertext Markup Language (HTML)*. HTML is one of the three primary [system components of the World Wide Web](#), and was invented in 1990 by the creator of the Web, Tim Berners-Lee. It was not created in a vacuum; rather, it is a specific application of the general concept of a markup language that is described in ISO standard 8879:1986: *Standard Generalized Markup Language (SGML)*.

The idea behind a markup language is to define special items that provide information to the software displaying the document about how it should be presented. For the purposes of hypertext, the most basic type of information in a document is a special instruction that specifies how one document can be linked to another—after all, this linking process is the defining attribute of hypertext.

However, HTML goes far beyond just this; it defines a full set of text codes for describing nearly every aspect of how a document is shown to a user. This includes instructions for formatting text (such as defining its color, size and alignment), methods for displaying tabular data, specifications for how to present images and other media along with the document, interactive forms and much more. In theory, the language is only supposed to define the document and leave up to the browser how it should be displayed, but in practice, modern HTML documents also usually contain rather specific instructions for how their information should be presented.

To do justice to HTML, I would have to devote several dozen pages to the subject. I have decided not to do this, because even though HTML is an important part of the Web, it is actually not that important in understanding how the Web works. Knowing HTML is essential if you are writing Web content, and is also critical if you want to understand how to write Web software. Perhaps ironically though, to the actual mechanisms that make the Web work, such as HTTP, “a document is a document”. HTTP is not designed under the assumption that it will transfer HTML, and servers in most cases do not even look at the contents of an HTML file—they just transfer it.

That said, a basic understanding of HTML is important, and it just wouldn't seem right not to provide at least an overview of the language, so I will do that here. I encourage you to seek out one of the many good HTML resources if you want to learn more: there are dozens of them on the World Wide Web (where else? 😊)

HTML Elements and Tags

In simplest terms, an HTML document is a plain ASCII text file like an e-mail message or other text document. The biggest difference between HTML and regular text, however, is that HTML documents are *structured*. The document is logically organized into a series of *elements* that are arranged according to the rules of the language. Each element defines one part of the document as a whole. For example, the title of a document, a paragraph, a table and a hyperlink to another document are all examples of elements.

Each element is described using special text *tags* that follow a particular syntax. Each tag begins with the “<” symbol, which is then followed by the (case-insensitive) element name, and optionally, additional parameters that describe the element. The tag ends with the “>” symbol. Here's how a tag looks generally:

```
<element parameter1="value1" parameter2="value2" ...>
```

Some elements are entirely described by the presence of a tag, and in such cases that tag is the entire element. More often, tags occur in pairs surrounding the actual content of the element; the *start tag* begins with the name of the element and the *end tag* begins with the name of the element preceded by a slash symbol. For example, the title of a document is an element defined as follows:

```
<title>This Is A Great Story</title>
```

The content of each element can contain other elements, which causes tags to be nested within each other. For example, if we wanted to highlight the word “Great” in our title by displaying it in bold letters, we can add the “” tag as follows:

```
<title>This Is A <b>Great</b> Story</title>
```

Each whole HTML document is in fact defined as a single “element” called “html”; the whole document is enclosed in “<html>” and “</html>” tags. Within this element, the document is divided into two standard sub-elements that must be present in each document: the *head* and the *body*. The head of the document contains information that describes the document and how it is to be processed; it most commonly contains the title of the document as described above. The body contains the actual content of the document. These three elements define the basic HTML document structure:

```
<html>
<head>
(head elements go here...)
</head>
<body>
(body elements go here...)
</body>
</html>
```

The bulk of the document consists of the body elements that are placed between the “<body>” and “</body>” tags. HTML documents can range from very simple bodies containing only elements such as text paragraphs and perhaps a few links, to very sophisticated documents that are computer-generated and contain hundreds or even thousands of nested tags of various sorts.

Common HTML Elements

Table 274 provides a brief description of some of the more common elements used in the body of an HTML message and the tags that define them, to give you a feel for how the language works:

Table 274: Common Hypertext Markup Language (HTML) Elements (Page 1 of 3)

Element	Example Element and Tags	Description
Paragraph	<pre><p>Jack and Jill went up the hill to fetch a pail of water...</p></pre>	Delineates a paragraph of text. Note that everything between the start and end tags will be considered one paragraph, even if split onto multiple lines as I have done here; line breaks are not significant in HTML formatting, only tags.
Line Break	<pre>George W. Bush
 The White House
 1600 Pennsylvania Ave., NW
 Washington, DC 20500</pre>	Forces a line break. Used instead of the paragraph tag to present lines close together, such as addresses.

Table 274: Common Hypertext Markup Language (HTML) Elements (Page 2 of 3)

Element	Example Element and Tags	Description
Heading	<pre><h1>First Topic</h1> <h2>Subtopic</h2></pre>	<p>Defines section headings, to allow information in a long document to be displayed in hierarchical form. Six sets of tags are defined, from <h1> and </h1> to <h6> and </h6>. Browsers will automatically display the “higher-level” headings in more prominent ways, by using larger fonts, underlining the text, or similar.</p>
List	<pre><p>Shopping list: Milk Eggs Sushi </p></pre>	<p>Allows information to be presented as a list. The tag “” means “unnumbered list” and causes the list items to be shown usually as bullet points. Alternately, “” (“ordered list”) can be used to show the items preceded by 1, 2, 3 and so on.</p>
Horizontal Rule	<pre>...end of this part of the story.</p> <hr size= “3”> <p>Start of next part of story...</pre>	<p>Draws a horizontal line across the page; the “size” parameter controls its thickness. Used to separate logical sections in a document.</p>
Image	<pre></pre>	<p>Displays an inline image in the appropriate section of the text. The “src” parameter is a relative or absolute URL for the image, and numerous other parameters can be included to define the image’s alignment, size, “alternate text” to display if the browser is non-graphical (as shown here with the “alt” parameter) and much more.</p>
Link	<pre>Click here to visit The PC Guide</pre>	<p>Hyperlinks to another document. The “a” in the tag stands for “anchor”, which is the formal name for a hyperlink. the “href” parameter specifies the URL of the link.</p> <p>Most browsers will underline or otherwise highlight the text between the start and end tags to make it clear that the text represents a hyperlink. It is also possible to give a hyperlink to an image by combining the “” and “<a>” tags.</p>
Bookmark	<pre>Step 4: Remove paint using scrubbing tool.</pre>	<p>Creates a bookmark that can be used to hyperlink to a particular section in a document. For example, if the bookmark in this example was in a document at URL “http://www.homefixitup.com/repainting.htm”, the URL “http://www.homefixitup.com/repainting.htm#Step4” refers to this particular place in the document. See the next topic on URLs for more details.</p>

Table 274: Common Hypertext Markup Language (HTML) Elements (Page 3 of 3)

Element	Example Element and Tags	Description
Table	<pre><table> <tr> <td>1st row, 1st column.</td> <td>1st row, 2nd column.</td> </tr> <tr> <td>2nd row, 1st column.</td> <td>2nd row, 2nd column.</td> </tr> </table></pre>	Displays information in tabular form. Each “<tr>” and “</tr>” tag set defines one row of the table; within each row, each “<td>” and “</td>” pair defines one table data element. Many different parameters can be provided for each of these tags to control table size and appearance.
Form	<pre><form method="POST" action="https:// www.myfavesite.com/order.php"> <input type="hidden" name="PRODUCT" value="widget"> <input type="text" name="QUANTITY" size="3"> <input type="submit" value="Click Here to Proceed to the Secure Processing Site"> </form></pre>	Defines an HTML form, allowing various sorts of information to be submitted by a client to a program on a Web site designed to process forms. The form consists of the initial “<form>” tag that describes what action to be taken when the submission button is pressed, and other form items such as predefined variables, text entry fields, and buttons; one example of each of these items is shown here.
Script	<pre><script language=javascript> (<i>Javascript code</i>) </script></pre>	Allows instructions in a scripting language to be included in an HTML document. Most often used for Javascript.

Common Text Formatting Tags

There are also numerous tags that are used to format the appearance of text within a document; some of the more common ones:

- ☉ **text**: Present the enclosed text in bold.
- ☉ **<i>text</i>**: Present the enclosed text in italics.
- ☉ **<u>text</u>**: Present the enclosed text underlined.
- ☉ **text**: Present the enclosed text using the indicated font type, size or color.

Again, this is just the tip of the iceberg when it comes to HTML. If you are not familiar with HTML, however, knowing these basic tags should be enough to help you interpret basic HTML documents and learn how HTTP works.



Key Concept: The language used by World Wide Web hypertext documents is called the *Hypertext Markup Language (HTML)*. HTML documents are as ASCII text files, but are arranged using a special structure of HTML *elements* that define the different parts of the document and how they should be displayed to the user. Each element is described using special text *tags* that define it and its characteristics.

World Wide Web Addressing: HTTP Uniform Resource Locators (URLs)

The main reason that hypertext is so powerful and useful is that it allows related documents to be linked together. In the case of the World Wide Web, this is done using a special set of [Hypertext Markup Language \(HTML\)](#) tags that specifies in one document the name of another document that is related in some important way. A user can move from one document to the next using a simple mouse click. The Web has succeeded largely on the basis of this simple and elegant method of referral.

The notion of hyperlinking has some important implications on how Web documents and other resources are addressed. Even though the Web is at its heart a message transfer protocol similar to the [File Transfer Protocol \(FTP\)](#), the need to be able to define hyperlinks meant that the traditional FTP model of using a set of commands to specify how to retrieve a resource had to be abandoned. Instead, a system was needed whereby a resource could be uniquely specified using a simple, compact string.

The result of this need was the definition of one of the three primarily elements of the World Wide Web: the *Uniform Resource Identifier (URI)*. URIs are divided into two categories: *Uniform Resource Locators (URLs)* and *Uniform Resource Names (URNs)*. While URIs, URLs and URNs grew out of the development of the Web, they have now been generalized to provide an addressing mechanism for a wide assortment of TCP/IP application layer protocols. They are thus [described in detail in a separate section](#); this topic will provide more information on how they are used specifically for the Web.

At the present time, the Web uses [URLs](#) almost exclusively; [URNs](#) are still in development. Web URLs specify the use of the [Hypertext Transfer Protocol \(HTTP\)](#) for resource retrieval, and are thus normally called *HTTP URLs*. These URLs allow a resource such as a document, graphical image or multimedia file to be uniquely addressed by specifying the host name, directory path and file name where it is located.



Key Concept: *Uniform Resource Identifiers (URIs)* were developed to allow World Wide Web resources to be easily and consistently identified; they are also now used for other protocols and applications. The type of URI currently used on the Web is the *Uniform Resource Locator (URL)*, which identifies the use of HTTP to retrieve a resource, and provides information on where and how it can be found and retrieved.

HTTP URL Syntax

HTTP URLs may be [absolute or relative](#). Absolute URLs are usually used for hyperlinks from one Web site to another, or by users requesting a new document without any prior context. Absolute HTTP URLs are based on the following [common Internet URL syntax](#):

```
<scheme>://<user>:<password>@<host>:<port>/<url-path>;<params>?<query>#<fragment>
```

For the Web, the scheme is “http:” and the semantics of the different URL elements is defined to have meanings that are relevant to the Web. The general structure of an HTTP URL is thus:

```
http://<user>:<password>@<host>:<port>/<url-path>?<query>#<bookmark>
```

The following shows how these syntactic elements are specifically defined for HTTP absolute URLs:

- ❶ **<user> and <password>**: Optional authentication information, for resources located on password-protected servers. This construct is rarely used in practice and so most people don't realize it is an option; it has thus become a target of abuse by con artists who use it to [obscure undesirable URLs](#).
- ❷ **<host>**: The host name of the Web server upon which the resource is located. This is usually a [fully-qualified DNS domain name](#), but may also be an IP address.
- ❸ **<port>**: The [TCP port number](#) to use for connecting to the Web server. This defaults to 80 for HTTP and is usually omitted. Rarely, you may see some other port number used, sometimes to allow two copies of Web server software devoted to different uses on the same IP address; port 8080 is especially common as an alternative.
- ❹ **<url-path>**: The path pointing to the specific resource to be retrieved using HTTP. This is usually a full directory path expressing the sequence of directories to be traversed from the root directory to the place where the resource is located, and then the resource's name. It's important to remember that the path is case-sensitive, even though DNS domain names are not.
- ❺ **<query>**: An optional query or other information to be passed to the Web server. This feature is commonly used to implement interactive functions, because the query value can be specified by the user and then be passed from the Web browser to the Web server. The alternative method is by using the [HTTP POST method](#).
- ❻ **<bookmark>**: Identifies a particular location within an [HTML document](#). This is commonly used in very large HTML documents to allow a user to click a hyperlink and scroll to a particular place in the document. See the example in the previous topic (near the end of [Table 274](#)).

Although the URL syntax for the Web is quite “rich” and potentially complex, most Web URLs are actually quite short. The vast majority of these components are omitted, especially the user, password, port and bookmark elements; queries are also used only for special purposes. This leaves the more simplified form you will usually encounter for URLs:

```
http://<host>/<url-path>
```

Resource Paths and Directory Listings

The <url-path> used to reference a particular document can also be omitted. This provides a convenient way for a user to see what content is offered on a Web site without needing to know what particular document to request. For example, a user who wants to just see what the current headlines are on CNN would just go to “http://www.cnn.com”. In this case, the request is sent to the Web server for the null document “/” (which is implied if it is not specified; technically you are supposed to specify “http://www.cnn.com/”).

How such a “/” request is handled depends on the server. Technically, such a request is actually asking the server “please show me the contents of the root directory of the server”. However, this is both ugly (a listing of file names is not the best way to make a first impression) and a potential security issue (as anyone can see the name of every file on the server). Instead, most HTTP servers are set up to automatically recognize such requests and return a default document, often named something like “index.html” or “default.html”. Many servers will similarly return a default document of some sort if any other directory is specified in a URL; for example, “http://www.pcguides.com/ref” actually returns “http://www.pcguides.com/ref/index.htm”.

The forms above apply to absolute HTTP URLs. URLs may also be relative; this is the norm for links between closely related documents, such as graphics that go with a document, or between documents in a set or project. In this case, usually only a fractional portion of a URL path is specified; this is described fully in [the topic on relative URLs](#).

Note that while it is technically incorrect to leave the “http://” off an HTTP URL, most Web browsers will add it automatically if omitted. As a result, many Web users are in the habit of entering “URLs” that are simply a host name, such as just “www.pcguides.com”.



TCP/IP Hypertext Transfer Protocol (HTTP)

The success of the [World Wide Web](#) is a result of the efficiency and usefulness of the complete hypermedia system it implements. We examined in [the last section](#) the basic concepts behind hypertext, and looked at two of the three major components that comprise the World Wide Web system: [HTML](#) and [URLs](#). The third major component of the Web is arguably the most important: the protocol that actually transfers hypertext documents and other files between Web servers and Web clients (browsers). This is one of the most widely-known software protocols in all of networking: the *Hypertext Transfer Protocol (HTTP)*.

In this section I provide a detailed description of the Hypertext Transfer Protocol. I begin with an overview of HTTP and a discussion of its history and versions, and the standards that define them. I then describe the operation of the protocol in five subsections. The first discusses HTTP's operation in general terms, focusing on how connections are established and maintained. The second describes HTTP messages and how they are formatted, and describes HTTP methods (commands) and status codes. The third details the many HTTP headers, which are critically important as they are the primary way that information is communicated between HTTP servers and clients. The fourth subsection provides information about how resources, called entities, are encoded and transferred in HTTP. The final subsection describes special features and capabilities of the modern HTTP protocol.



Background Information: Like so many TCP/IP protocols, when HTTP was designed, its creators “borrowed” elements from other application protocols. In this case, HTTP uses certain elements from e-mail, especially the [Multipurpose Internet Mail Extensions \(MIME\)](#). I would recommend familiarity with both the [RFC 822 e-mail message format](#) and MIME, especially MIME [headers](#) and [media types](#), before reading this section. The relationship between HTTP and MIME is covered in [the topic discussing HTTP entities and media types](#).

HTTP Overview, History, Versions and Standards

The World Wide Web had [humble beginnings](#), as a research project at the Swiss research institute, CERN. The primary goal of the project was to allow hypertext documents to be electronically linked, so selecting a reference in one document to a second one would cause it to be retrieved. To implement this system, some sort of mechanism was needed to allow a client computer to tell a server to send it a document. To fill this function, the early developers of the Web created a new TCP/IP application layer protocol: the *Hypertext Transfer Protocol (HTTP)*.

HTTP/0.9

The original version of HTTP was intended only for the transfer of hypertext documents, and was designed to be very simple to make implementation of the fledgling Web easier. This early HTTP specifies that an HTTP client establishes a connection to an HTTP server using [TCP](#). The client then issues a single “GET” request specifying a resource to be retrieved. The server responds by sending the file as a stream of text bytes, and the connection is terminated. The entire document defining this version of HTTP is only a couple of pages long!

This first version of HTTP was functional, but extremely limited in its capabilities. It didn't support the transfer of any types of data other than hypertext, and it provided no mechanism for any sort of “intelligent” communication between the client and server. This early HTTP prototype was not up to the task of providing the basis for data transfer for the future of the World Wide Web. It was never made an official RFC standard, and in fact, never even had a formal version number; it is known today as HTTP version 0.9, or “HTTP/0.9” using the version format used by HTTP. I believe this number has no particular significance other than being a bit smaller than the number of the first official version of the protocol.

HTTP/1.0

The skeleton of functionality that HTTP/0.9 formed the basis for a rapid evolution of HTTP in the early 1990s. As the World Wide Web grew in size and acceptance, many new ideas and features were incorporated into HTTP. The result of a great deal of development effort was the formalization of the first HTTP standard: version 1.0. This much enhanced HTTP was published in May 1996 as RFC 1945, *Hypertext Transfer Protocol — HTTP/1.0*. It had been in use for several years prior to that formal publication date, however.

HTTP/1.0 transformed HTTP from a trivial request/response application to a true messaging protocol. It described a complete message format for HTTP, and explained how it should be used for client requests and server responses. One of the most important changes in HTTP/1.0 was the generalization of the protocol to handle many types of different media, as opposed to strictly hypertext documents. This was done by borrowing concepts and header constructs from the [Multipurpose Internet Mail Extensions \(MIME\)](#) standard defined for e-mail. At the same time that it defined much more capable Web servers and clients, HTTP/1.0 retained backwards compatibility with servers and clients still using HTTP/0.9.

HTTP/1.0 was the version of HTTP that was widely implemented in the mid-1990s as the Web exploded in popularity. After only a couple of years, HTTP accounted for the majority of the traffic on the burgeoning Internet. The popularity of HTTP was in fact so great that it single-handedly prompted the installation of a lot of new hardware to handle the load of browser requests and Web server replies.

Unfortunately, much of this huge load of traffic was due to some limitations in HTTP itself. These only became apparent due to the tremendous growth in the use of the protocol which, combined with the normal growing pains of the Internet, led to many frustrated Web users. The inefficiencies of HTTP version 1.0 were a result of design limitations such as the need for each site to be hosted on a different server, the fact that each HTTP session handled only one client request, and a general lack of support for necessary performance-enhancing features such as caching, proxying and partial resource retrieval.

HTTP/1.1

While impatient pundits coined sarcastic terms such as the “World Wide Wait”, the IETF continued to work to improve HTTP. In January 1997, the first draft version of HTTP/1.1 appeared: in RFC 2068. This document was later revised and published as RFC 2616, *Hypertext Transfer Protocol — HTTP/1.1*, in June 1999. HTTP/1.1 retains backwards compatibility with both HTTP/1.0 and HTTP/0.9. It is accompanied by RFC 2617, *HTTP Authentication: Basic and Digest Access Authentication*, which deals with security and authentication issues.

HTTP/1.1 introduces several significant improvements over version 1.0 of the protocol, most of which specifically address the performance problems I just described. Some of the more important improvements in version 1.1 are:

- ☉ **Multiple Host Name Support:** In HTTP/1.0, there was no way to specify the host name of the server to which the client needed to connect. As a result, the Web server at a particular IP address could only support one domain name. This was not only inefficient, it was exacerbating the [depletion of IP addresses](#) in the 1990s, because each new Web server to come online required a new IP address. HTTP/1.1 allows one Web server to handle requests for dozens or even hundreds of different virtual hosts.
- ☉ **Persistent Connections:** HTTP/1.1 allows a client to send multiple requests for related documents to a server in a single TCP session. This greatly improves performance over HTTP/1.0, where each request required a new connection to the server.
- ☉ **Partial Resource Selection:** In HTTP/1.1, a client can ask for only part of a resource rather than the entire document, which reduces the load on the server and saves transfer bandwidth.
- ☉ **Better Caching and Proxying Support:** HTTP/1.1 includes many provisions to make caching and proxying more efficient and effective than they were in HTTP/1.0. These techniques can improve performance by providing clients with faster replies to their requests while reducing the load on servers, as well as enhancing security and implementing other functionality.
- ☉ **Content Negotiation:** A negotiation feature was added that allows the client and server to exchange information to help select the best resource or version of a resource when multiple variants are available.

-
- ☉ **Better Security:** HTTP/1.1 defines authentication methods and is generally more “security aware” than HTTP/1.0 was.

In addition to these notable improvements, many other minor enhancements were made in HTTP/1.1. Several of these take the form of new headers that can be included in client requests to better control under what circumstances resources are retrieved from the server, and headers in server responses to provide additional information to the client.

Future HTTP Versions

HTTP/1.1 continues to be the current version of the Hypertext Transfer Protocol, even though it is now several years old. This may seem somewhat surprising, given how widely used HTTP is. Then again, it may be the fact that so many millions of servers and clients implement HTTP/1.1 that no new version has been created. For a while there was speculation that version 1.2 of HTTP would be developed, but this has not happened.

In the late 1990s, work began on a method of expanding HTTP through extensions to the existing version 1.1. Development of the *HTTP Extension Framework* proceeded for a number of years, and in 1998 a proposed draft for a new Internet standard was created. However, as I just said, HTTP/1.1 is so widely deployed and so important that it was very difficult to achieve consensus on any proposal to modify it. As a result, when the HTTP Extension Framework was finally published in February 2000 as RFC 2774, the universal acceptance required for a new standard did not exist. The framework was given “experimental” status, and never became a formal standard.



Key Concept: The engine of the World Wide Web is the application protocol that defines how Web servers and clients exchange information: the *Hypertext Transfer Protocol (HTTP)*. The first version of HTTP, HTTP/0.9, was part of the early World Wide Web and was a very simple request/response protocol with limited capabilities that could transfer only text files. The first widely-used version was HTTP/1.0, which is a more complete protocol that allows the transport of many types of files and resources. The current version is HTTP/1.1, which expands HTTP/1.0’s capabilities with several features that improve the efficiency of transfers and address many of the needs of the rapidly growing modern World Wide Web.

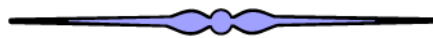

HTTP General Operation and Connections

The Hypertext Transfer Protocol (HTTP) began as an extremely basic protocol, designed to do just one thing: allow a client to send a simple request for a hypertext file and receive it back from the server. Modern HTTP remains at its heart a straight-forward request/reply protocol, but now includes many new features and capabilities to support the growing size of the World Wide Web and the ever-increasing variety of ways that people have found to use it. The best place to start in explaining HTTP is thus by looking at its operation as a whole and how communication takes place between a Web server and a Web client.

In this section I introduce the Hypertext Transfer Protocol by describing its operation in general terms. I begin with a high-level overview of HTTP and discussion of its operational model. I explain the two types of connections that are supported between HTTP clients and servers, and the method by which requests can be pipelined in HTTP/1.1. I then provide more information about how persistent connections are established, managed and terminated in the current version of HTTP.

HTTP Operational Model and Client/Server Communication

The Hypertext Transfer Protocol is the application-layer protocol that implements the World Wide Web. While the Web itself has many different facets, HTTP is only concerned with one basic function: the transfer of hypertext documents and other files from Web servers to Web clients. In terms of actual communication, clients are chiefly concerned with making requests to servers, which respond to those requests.

Thus, even though HTTP includes a lot of functionality to meet the needs of clients and servers, when you boil it down, what you see is a very simple, client/server, request/response protocol. In this respect, HTTP more closely resembles a rudimentary protocol like [BOOTP](#) or [ARP](#) than it does other application-layer protocols like [FTP](#) and [SMTP](#), which all involve multiple communication steps and command/reply sequences.

Basic HTTP Client/Server Communication

In its simplest form, the operation of HTTP involves only an HTTP client, usually a *Web browser* on a client machine, and an HTTP server, more commonly known as a *Web server*. After a TCP connection is created, the two steps in communication are as follows:

1. **Client Request:** The HTTP client sends a request message formatted according to the rules of the HTTP standard—an *HTTP Request*. This message specifies the resource that the client wishes to retrieve, or includes information to be provided to the server.
2. **Server Response:** The server reads and interprets the request. It takes action relevant to the request and creates an *HTTP Response* message, which it sends back to the client. The response message indicates whether the request was successful, and may also contain the content of the resource that the client requested, if appropriate.

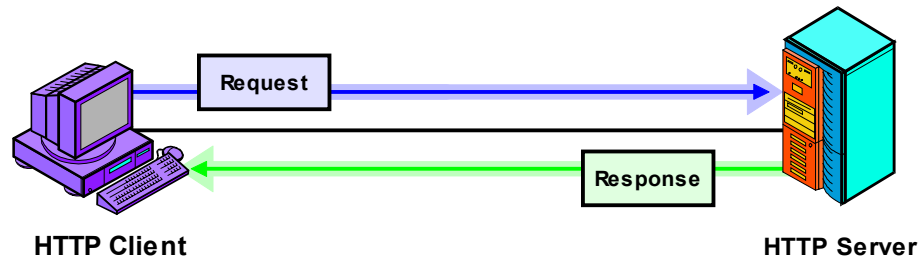

Figure 315: HTTP Client/Server Communication

In its simplest form, HTTP communication consists of an HTTP Request message sent by a client to a server, which replies with an HTTP Response.

In HTTP/1.0, each TCP connection involves only one such exchange, as shown in [Figure 315](#); in HTTP/1.1, multiple exchanges are possible, as we'll see in [the next topic](#). Note also that the server may in some cases respond with one or preliminary responses prior to sending the full response. This may occur if the server sends a preliminary response using the “100 Continue” status code prior to the “real” reply. [See the topic on HTTP status codes for more information.](#)



Key Concept: HTTP is a client/server-oriented, request/reply protocol. Basic communication consists of an *HTTP Request* message sent by an *HTTP client* to an *HTTP server*, which returns an *HTTP Response* message back to the client.

Intermediaries and The HTTP Request/Response Chain

The simple request/response pair between a client and server becomes more complex when *intermediaries* are placed in the virtual communication path between the client and server. These are devices such as *proxies*, *gateways* or *tunnels* that are used to improve performance, provide security or perform other necessary functions for particular clients or servers. Proxies are particularly commonly used on the Web, because they can greatly improve response time for groups of related client computers.

When an intermediary is involved in HTTP communication, it acts as a “middleman”. Rather than the client speaking directly to the server and vice-versa, they each talk to the intermediary. This allows the intermediary to perform functions such as caching, translation, aggregation, or encapsulation. For example, consider an exchange through a single intermediary device. The two-step communication process above would become four steps:

1. **Client Request:** The HTTP client sends a request message to the intermediary device.
2. **Intermediary Request:** The intermediary processes the request, making changes to it if necessary. It then forwards the request to the actual server.
3. **Server Response:** The server reads and interprets the request, takes appropriate action and then sends a response. Since it received its request from the intermediary, its reply goes back to the intermediary.

-
4. **Intermediary Response:** The intermediary processes the request, again possibly making changes, and then forwards it back to the client.

As you can see, the intermediary acts as if it were a server from the client's perspective, and as a client from the server's viewpoint. Many intermediaries are designed to be able to “intercept” a variety of TCP/IP protocols, by “posing” as the server to a client and the client to a server. Most protocols are unaware of the existence of the interposition of an intermediary in this fashion. HTTP, however, includes special support for certain intermediaries such as [proxy servers](#), providing headers that control how intermediaries handle HTTP requests and replies.

It is possible for two or more intermediaries to be linked together between the client and server. For example, the client might send a request to intermediary 1, which then forwards to intermediary 2, which then talks to the server; see [Figure 316](#). The process is reversed for the reply. The HTTP standard uses the phrase *request/response chain* to refer collectively to the entire set of devices involved in an HTTP message exchange.

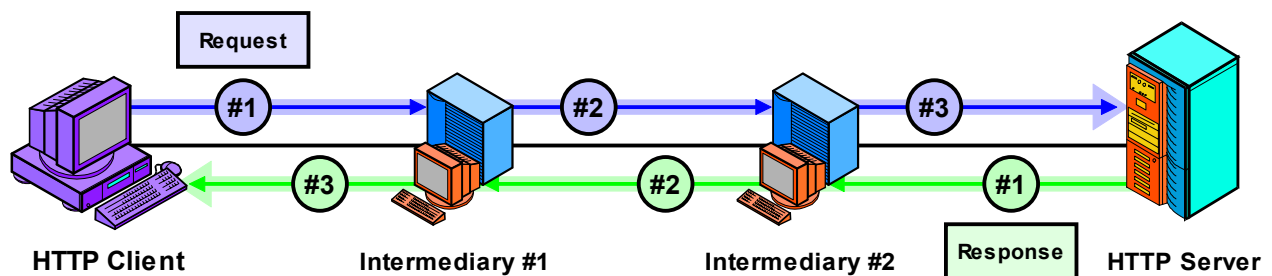

Figure 316: HTTP Request/Response Chain Using Intermediaries

Instead of being connected directly, an HTTP client and server may be linked using one or more intermediary devices such as proxies. In this example, two intermediaries are present. The *HTTP Request* sent by the client will actually be transferred three times: from the client to the first intermediary, then to the second, and finally to the server. The *HTTP Response* will likewise be created once but transmitted three distinct times. The full set of devices participating in the message exchange is called the request/response chain.



Key Concept: The simple client/server operational model of HTTP is complicated when *intermediary devices* such as proxies, tunnels or gateways are inserted in the communication path between the HTTP client and server. HTTP/1.1 is specifically designed with features to support the efficient conveyance of requests and responses through a series of steps from the client through the intermediaries to the server, and back again. The entire set of devices involved in such a communication is called the *request/response chain*.

The Impact of Caching on HTTP Communication

The normal HTTP communication model is changed through the application of *caching* to client requests. Caching is employed by various devices on the Web to store recently-retrieved resources so they can be quickly supplied in reply to a request. The client itself will

cache recently-accessed Web documents so that if the user asks for them again they can be displayed without even making a request to a server. If a request is in fact required, any intermediary device can satisfy a request for a file if the file is in its cache.

When a cache is used, the device that has the cached resource requested returns it directly, “short-circuiting” the normal HTTP communication process. In the example above, if intermediary 1 has the file the client needs, it will supply it back to the client directly, and intermediary 2 and the real Web server that the client was trying to reach originally will not even be aware that a request was ever made; [the topic on HTTP caching](#) discusses the subject in much more detail.



Note: Most requests for Web resources are made using [HTTP URLs](#) based on a [Domain Name System \(DNS\)](#) host name. The first step in satisfying such requests is to [resolve the DNS domain name into an IP address](#), but this process is separate from the HTTP communication itself.

HTTP Transitory and Persistent Connections and Pipelining

The [basic HTTP communication process](#) is a simple “two-step dance”: a client sends a request to a server and the server replies back to the client. Since this was all that HTTP was intended to do, the first version of the protocol was designed so that after a TCP connection was established between the client and server, a single request/response exchange was performed. The request satisfied, the TCP connection would then be terminated.

Transitory Connections

These connections, called *transitory* due to their short-lived nature, were the only type supported by the original HTTP/0.9, and the same model was maintained in the more widely-deployed HTTP/1.0. The advantage of this connection model is its conceptual simplicity; the problem with it is that it is inefficient when the client needs to make many requests to the same server. This is often the case with modern hypertext documents, which usually carry inline references to images and other media. A typical client request for the home page of a Web site begins with a single request for an HTML file, but then leads to subsequent requests for each of the other related files that go with that document.

With transitory connections, each of these requests made by the client requires a new, distinct [TCP connection](#) to be set up between the client and server. Every connection takes server resources and network bandwidth, so having to establish a new one for each file is woefully inefficient. Suppose that you were having a conversation with someone whom you needed to ask a series of questions. Now imagine that after answering each question, the other person hung up the phone and you had to call them up again! You get the picture.

There are some people who consider the temporary nature of HTTP/0.9 and HTTP/1.0 connections to be a “design flaw” of these early versions of HTTP, but I don't think that this is necessarily very fair. In the early days, this model of operation was really not a big issue; it only became problematic when the use of the Web and hypertext evolved.

For the first few years of its existence, hypertext was primarily that: **text**. Having an HTTP session only last long enough for one request/response was generally sufficient since the whole resource was in one file. It was only in the 1990s that hypertext became *hypermedia*, with a heavy emphasis on embedded graphics and other files. When Web pages changed from simple text to multimedia marvels sporting dozens or even hundreds of embedded images, the limitations of HTTP/1.0 really became obvious.

Persistent Connections

The solution to the inefficiency problem of transitory connections came in HTTP/1.1, which allows an HTTP client and server to set up a *persistent connection*. The basic operation of HTTP is not changed; the main difference is that by default, the TCP connection is kept open after each request/response set, so that the next request and response can be exchanged immediately. The session is only closed when the client is done requesting all the documents it needs.

Keeping the TCP connection between an HTTP client and server alive between requests is probably the single most important way that HTTP/1.1 improves performance over version 1.0. Clients are able to get their files more quickly because they don't have to wait for a TCP connection before each resource is retrieved. Server load is reduced and memory use in busy servers is conserved. Network congestion is reduced through the elimination of unnecessary [TCP handshaking segments](#).

Pipelining

Persistent connections offer another important performance-enhancing option to HTTP clients: the ability to *pipeline* requests. Suppose the client needs to send a request for files *A*, *B* and *C* to a server. Since the requests for all of these files will be sent in the same TCP session, there is no need for the client to wait for a response to its request for *A* before sending the request for *B*. The client can send requests “rapid-fire”, one after the other. This also improves the efficiency of the server, which will be able to fill the requests in the order in which they are received, as soon as it is able, without having to pause to wait for each new request to be sent.



Key Concept: HTTP/0.9 and HTTP/1.0 only supported *transitory connections* between an HTTP client and server, where just a single request and response could be exchanged on a TCP connection. This is very inefficient for the modern Web, where clients frequently need to make dozens of requests to a server. HTTP/1.1 operates by default using *persistent connections*: once a TCP connection is established, the client can send many requests to the server and receive replies to each in turn. This allows files to be retrieved more quickly, and conserves server resources and Internet bandwidth. The client can even *pipeline* its requests, sending the second one immediately, without having to first wait for a reply to the first one. HTTP/1.1 still supports transitory connections for backwards compatibility, when needed.

Complications Arising From Persistent Connections and Pipelining

The obvious advantages of persistent connections make them the default for modern HTTP communication, but they do have one drawback: they complicate the process of sending data from the server to the client. With transitory connections, the client knows that all of the data it receives back from the server is in reply to the one request it sent. Once it has all the bytes the server sent and the TCP session ends, the client knows the file is complete.

With persistent connections, and especially when pipelining is used, the server will typically be sending one file after the other to the client, which must differentiate them. Remember that TCP just sends data as a series of unstructured bytes; the application must take care of specifying where the dividing points are between files. This means that persistent connections and pipelining lead to [data length issues that must be specially addressed in HTTP](#).

To provide compatibility with older versions of the software, HTTP/1.1 servers still support transitory connections, and will automatically close the TCP connection after one response if they receive an HTTP/0.9 or HTTP/1.0 request. HTTP/1.1 clients may also specify that they do not want to use persistent connections in their initial request. The next topic describes how persistent connections are created and managed.

HTTP Persistent Connection Establishment, Management and Termination

The introduction of [persistent connections](#) greatly improved the efficiency of HTTP by cutting out most of the overhead involved in a sequence of HTTP/1.0 requests between a client and server pair. These connections have now become the standard for client/server communication on the Web.

Connection Establishment

Like most TCP/IP client/server protocols, the server in HTTP plays the passive role by listening for requests on a particular port number. The default port number for HTTP is [well-known TCP port](#) number 80, and is used by Web browsers for most HTTP requests, unless a different port number is specified in the [URL](#). The client initiates an HTTP connection by opening a TCP connection from itself to the server it wishes to contact.



Note: A [DNS name resolution](#) step may precede the entire HTTP connection, since most URLs contain a host name, while HTTP requires that the client know the server's IP address. This can cause confusion, especially since DNS uses [UDP](#) where HTTP uses [TCP](#).

Once the TCP connection is active, the client sends its first request message. As we will see in [the next section](#), the request specifies what version of HTTP the client is using. If this is HTTP/0.9 or HTTP/1.0, the server will automatically work in the transitory connection model, and will only send one reply and then close the link. If it is HTTP/1.1, the assumption is that a persistent connection is desired. An HTTP/1.1 client can override this by including the special *Connection: close* header in its initial request, which tells the server it does not want to keep the session active after the request it is sending has been fulfilled.

Persistent Connection Use and Management

Assuming that a persistent connection is being used, the client may begin pipelining subsequent requests after sending its first request, while waiting for a response from the server to the initial query. As the server starts to respond to requests, the client processes them and takes action such as displaying the data retrieved to the user. The data received from the server may also prompt the client to request more files on the same connection, as in the case of an HTML document that contains references to images.

The server will generally buffer a certain number of pipelined requests from the client. In the case where the client sends too many requests too quickly, the server may “throttle back” the client using the [flow control mechanism built into TCP](#). In theory, the server could also just decide to terminate the connection with the client, but it is better for it to use TCP's existing features. Closing the connection will cause the client to initiate a new connection, potentially exacerbating any overloading problem.

Connection Termination

The flow of requests and responses continues for as long as the client has requests. The connection can be gracefully terminated by the client by including the *Connection: close* header in the last request it needs to send to the server. All requests are filled in order, so the server will satisfy all outstanding requests and then close the session.

Since HTTP/1.1 supports pipelining of requests, there is usually no need for a client to establish more than one simultaneous connection to the same server. Clients occasionally do this anyway to allow them to get information from a server more quickly. This is considered by many to be “anti-social”, because it can lead to a busy server's resources being monopolized by one client to the exclusion of others that want to access it.

Under special circumstances, either the client or the server may unexpectedly close an active persistent connection. For example, if the client detects that too much time has elapsed since the server last replied, it may conclude that the server has crashed and

terminate the connection. Similarly, the server might receive a shutdown command from its administrator or for other reasons end a session with a client abruptly. Servers normally avoid closing down a link during the middle of sending a response.

Both clients and servers must be able to handle abrupt session termination. For servers, there is not much to do; if the client terminates the connection the server simply “cleans up” any resources associated with the connection, and goes on to service the next client.

Clients have more to do when a server prematurely terminates a session, and this is especially the case when requests are pipelined. The client must keep track of all requests sent to the server to ensure that each is filled. If the server closes the session unexpectedly, the client will usually attempt to establish a new connection to retransmit the unfilled requests. Since an abrupt session close is often a sign of a busy server, the HTTP standard specifies that clients use a binary exponential backoff algorithm to wait a variable but increasing amount of time before submitting re-requests for files (similar in concept to the method used to deal with collisions in Ethernet). This helps prevent clients from “piling on” requests to a device that is already overwhelmed.



HTTP Messages, Message Formats, Methods and Status Codes

As we saw in [the operational overview of the Hypertext Transfer Protocol](#), HTTP is entirely oriented around the sending of client requests and server responses. These take the form of *HTTP messages* sent between clients and servers. As with all protocols, HTTP uses a special format that dictates the structure of both client request messages and server response messages; understanding how these messages work is a big part of comprehending HTTP as a whole.

In this section I describe the messages used by HTTP and the specific commands and responses issued by clients and servers. I begin with a look at the generic HTTP message format and the major components of every HTTP message. I then discuss the specific formats used for both requests and responses. I explain the different types of HTTP methods (commands) used in client requests, and the HTTP status codes used in server replies.



Note: Much of the functionality of HTTP is implemented using *header fields* that appear at the start of each HTTP request and response. Due to the number of headers and their potential complexity, they are covered in detail in [their own section](#).

HTTP Generic Message Format

As we've already seen, all of the communication between devices using the Hypertext Transfer Protocol takes place via *HTTP messages*, of which there are only two types: *requests* and *responses*. Clients usually send requests and receive responses, while servers receive requests and send responses. Intermediate devices such as gateways or proxies may send and receive both types of message.

All HTTP messages are created to fit a message structure that the standard calls the *generic message format*. Like most of the other TCP/IP messaging protocols such as [SMTP](#) and [NNTP](#), HTTP messages do not use a binary message format; rather, they are text-based. HTTP messages are based loosely on the electronic mail [RFC 822 and 2822 message standards](#), as well as the [Multipurpose Internet Mail Extensions \(MIME\)](#) standard. I say "loosely" because HTTP messages are similar in construction to e-mail messages but do not strictly follow all of the e-mail or MIME format requirements. For one thing, not all of the RFC 822 and MIME headers are used; there are other differences as well, which we will soon examine.

The HTTP generic message format is as follows:

```
<start-line>
<message-headers>
<empty-line>
[<message-body>]
[<message-trailers>]
```

You can see that this is pretty much the same as [the format used for e-mail messages](#) and [for Usenet newsgroup messages](#) too: headers, an empty line and then a message body. All text lines are terminated with the standard “CRLF” control character sequence; the empty line contains just those two characters and nothing else. The headers are always sent as regular text; the body, however, may be either text or 8-bit binary information, depending on the nature of the data to be sent. (This is another way that HTTP does not adhere strictly to the RFC 822 standard; [see the discussion of entities and media types](#) for a full discussion.)

The *start line* is a special text line that conveys the nature of the message. In a request, this line indicates the nature of the request, in the form of a *method*, as well as specifying a URI to indicate the resource that is the object of the request. Responses use the start line to indicate status information in reply to a request. More details on the use of the start line can be found in the next two topics that detail [request messages](#) and [response messages](#) respectively.

Header Format

There are many dozens of message headers defined in HTTP, which are organized into groups by function as we will soon see. Almost all of these are optional; the one exception is the *Host* header, which must be present in each request in HTTP/1.1. Headers may be sent in any order, and all follow the same header format used in e-mail messages:

<header-name>: <header-value>

Message Body Contents

The message body is optional, because it is only needed for certain types of messages. The body may carry a set of information to be communicated between the client and server, such as a detailed error message in a response. More commonly, when present, it carries a file or other resource, which is formally called an *entity* in the HTTP standard. Entities are most often found in the body of a response message, since most client requests ask for a server to send a file or other resource. However, they can also be found in certain requests. HTTP supports many kinds of entities and provides encoding methods to support a wide range of media. Special headers describe the characteristics of the entity, if present. HTTP entities and related issues are described in detail in [their own section of the Guide](#).



Key Concept: All HTTP messages conform to a structure called the *generic message format*. This format is based on the RFC 822 and MIME electronic mail message standards, though HTTP does not follow those formats precisely. Each HTTP message begins with a *start line*, then contains a number of *message headers*, followed by an empty line and optionally a *message body*. The body of the message may contain a resource such as a file to be communicated between client and server, called an *entity*.

Chunking and Message Trailers

HTTP/1.1 uses persistent connections by default, so messages are sent in a steady stream from client to server and server to client. This requires that some means be used to mark where one message ends and the next begins, which is usually accomplished in one of two ways. The first is using a special header that indicates the length of the message so the receiving device knows when the entire message has been received. The second is a method called “chunking”, where a message is broken into pieces for transmission and the length of each piece indicated in the message body.

When chunking is done, a set of message *trailers* may follow the body of the message. Trailers are in fact the same as headers except for their position in the file, but may only be used for entity headers. [See the topic on data length issues, “chunked” transfers and trailers](#) for more details on all of these matters.

HTTP Request Message Format

The client initiates an HTTP session by opening a TCP connection to the HTTP server with which it wishes to communicate. It then sends *request messages* to the server, each of which specifies a particular type of action that the user of the HTTP client would like the server to take. Requests can be generated either by specific user action (such as clicking a hyperlink in a Web browser) or indirectly as a result of a prior action (such as a reference to an inline image in an HTML document leading to a request for that image.)

HTTP requests use a message format that is based on the generic message format described in [the preceding topic](#), but specific to the needs of requests. The structure of this format is as follows (see [Figure 317](#)):

```
<request-line>
<general-headers>
<request-headers>
<entity-headers>
<empty-line>
[<message-body>]
[<message-trailers>]
```

Request Line

The generic *start line* that begins all HTTP messages is called a *request line* in request messages. Its has a three-fold purpose: to indicate the command or action that the client wants performed; to specify a resource upon which the action should be taken; and to indicate to the server what version of HTTP the client is using. The formal syntax for the request line is:

```
<METHOD> <request-uri> <HTTP-VERSION>
```

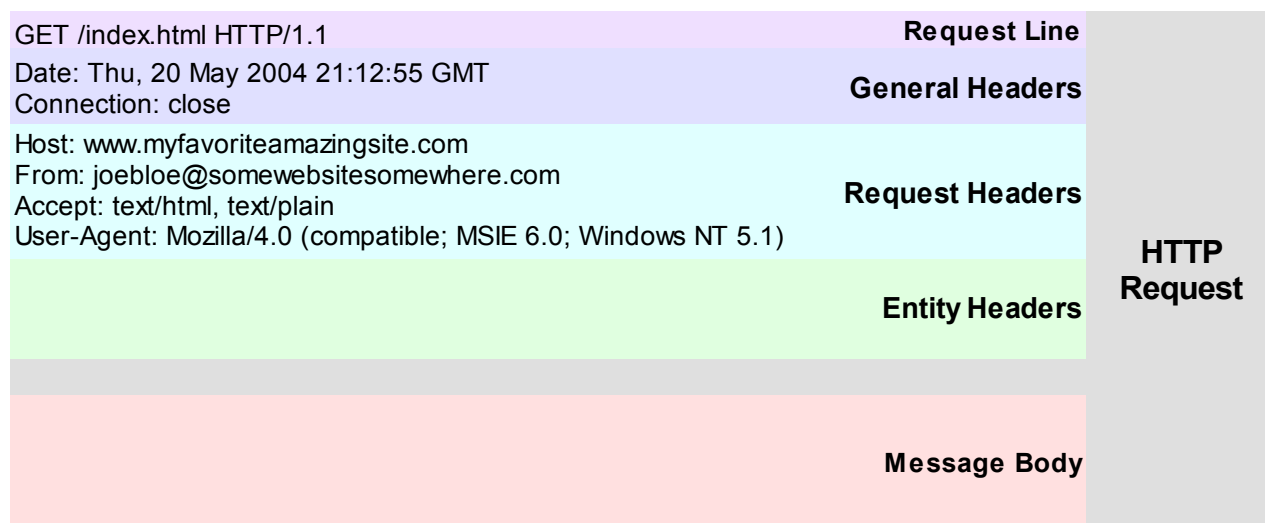

Figure 317: HTTP Request Message Format

This diagram shows the structural elements of an HTTP request and an example of the sorts of headers a request might contain. Like most HTTP requests, this one carries no entity, so there are no entity headers and the message body is empty. See [Figure 318](#) for the HTTP response format.

Method

The *method* is simply the type of action that the client wants the server to take; it is always specified in upper case letters. There are eight standard methods defined in HTTP/1.1, of which three are widely used: *GET*, *HEAD* and *POST*. They are called “methods” rather than “commands” because the HTTP standard uses terminology from object-oriented programming. I explain this and also describe the methods themselves in [the topic describing HTTP methods](#).

Request URI

The *request URI* is the [uniform resource identifier](#) of the resource to which the request applies. While URIs can theoretically refer to either [uniform resource locators \(URLs\)](#) or [uniform resource names \(URNs\)](#), at the present time a URI is almost always an [HTTP URL that follows the standard syntax rules of Web URLs](#).

Interestingly, the exact form of the URL used in the HTTP request line usually differs from that used in HTML documents or entered by users. This is because some of the information in a full URL is used to control HTTP itself. It is needed as part of the communication between the user and the HTTP client, but not in the request from the client to the server. The standard method of specifying a resource in a request is to include the path and file name in the request line (as well as any optional query information) while specifying the host in the special *Host* header that must be used in HTTP/1.1 requests.

For example, suppose the user enters a URL such as this:

http://www.myfavoritewebsite.com:8080/chatware/chatroom.php

We obviously don't need to send the "http:" to the server. The client would take the remaining information and split it so the URI was specified as "/chatware/chatroom.php" and the *Host* line would contain "www.myfavoritewebsite.com:8080". Thus, the start of the request would look like this:

```
GET /chatware/chatroom.php HTTP/1.1
Host: www.myfavoritewebsite.com:8080
```

The exception to this rule is when a request is being made to a [proxy server](#). In that case, the request is made using the full URL in its original form, so that it can be processed by the proxy just as the original client did. The request would be:

```
GET http://www.myfavoritewebsite.com:8080/chatware/chatroom.php HTTP/1.1
```

Finally, there is one special case where a single asterisk can be used instead of a real URL. This is for the *OPTIONS* method, which does not require the specification of a resource. (Nominally, the asterisk means the method refers to the server itself.)

HTTP Version

The *HTTP-VERSION* element tells the server what version the client is using so the server knows how to interpret the request, and what to send and not to send the client in its response. For example, a server receiving a request from a client using versions 0.9 or 1.0 will assume that a [transitory connection is being used rather than a persistent one](#), and will avoid using version 1.1 headers in its reply. The version token is sent in upper case as "HTTP/0.9", "HTTP/1.0" or "HTTP/1.1"—just the way I've been doing throughout my discussion of the protocol.

Headers

After the request line come any of the headers that the client wants to include in the message; it is in these headers that details are provided to the server about the request. The headers all use the same structure, but are organized into categories based on the functions they serve, and whether they are specific to one kind of message or not:

- ☉ **General Headers:** General headers refer mainly to the message itself, as opposed to its contents, and are used to control its processing or provide the recipient with extra information. They are not particular to either request or response messages, so they can appear in either. They are likewise not specifically relevant to any entity the message may be carrying.
- ☉ **Request Headers:** These headers convey to the server more details about the nature of the client's request, and give the client more control over how the request is handled. For example, special request headers can be used by the client to specify a conditional request—one that is only filled if certain criteria are met. Others can tell the server which formats or encodings the client is able to process in a response message.
- ☉ **Entity Headers:** These are headers that describe the entity contained in the body of the request, if any.

Request headers are obviously used only in request messages, but both general headers and entity headers can appear in either a request or a response message. Since there are so many headers and most are not particular to one message type, they are described in detail in [their own complete section](#).



Key Concept: *HTTP requests* are the means by which HTTP clients ask servers to take a particular type of action, such as sending a file or processing user input. Each request message begins with a *request line*, which contains three critical pieces of information: the *method* (type of action) the client is requesting; the *URI* of the resource upon which the client wishes the action to be performed, and the version of HTTP that the client is using. After the request line come a set of message headers related to the request, followed by a blank line and then optionally, the message body of the request.

HTTP Response Message Format

Up and down; east and west; black and white; yin and yang. Well, you get the idea. Each request message sent by an HTTP client to a server prompts the server to send back a *response message*. Actually, in certain cases the server may in fact send two responses, a preliminary response followed by the real one. Usually though, one request yields one response, which indicates the results of the server's processing of the request, and often also carries an entity (file or resource) in the message body.

Like requests, responses use their own specific message format that is based on the [HTTP generic message format](#). The format, shown in [Figure 318](#), is:

```
<status-line>  
<general-headers>  
<response-headers>  
<entity-headers>  
<empty-line>  
[<message-body>]  
[<message-trailers>]
```

Status Line

The *status line*—not “response line”, note—is the start line used for response messages. It has two functions: to tell the client what version of the protocol the server is using, and to communicate a summary of the results of processing the client's request. The formal syntax for the status line is:

```
<HTTP-VERSION> <status-code> <reason-phrase>
```

HTTP/1.1 200 OK	Status Line	HTTP Response
Date: Thu, 20 May 2004 21:12:58 GMT	General Headers	
Connection: close		
Server: Apache/1.3.27	Response Headers	
Accept-Ranges: bytes		
Content-Type: text/html	Entity Headers	
Content-Length: 170		
Last-Modified: Tue, 18 May 2004 10:14:49 GMT		
<html>	Message Body	
<head>		
<title>Welcome to the Amazing Site!</title>		
</head>		
<body>		
<p>This site is under construction. Please come back later. Sorry!</p>		
</body>		
</html>		

Figure 318: HTTP Response Message Format

This figure illustrates the construction of an HTTP response, and includes an example of both message headers and body. The status code “200” indicates that this is a successful response to a request; it contains a brief text HTML entity in the message body. See [Figure 317](#) for the HTTP request format.

HTTP Version

The *HTTP-VERSION* label in the status line serves the same purpose as it does in the [request line of a request message](#); here, it tells the client the version number that the server is using for its response. It uses the same format as in the request line, in upper case as “HTTP/0.9”, “HTTP/1.0” or “HTTP/1.1”. The server is required to return an HTTP version number that is no greater than that the client sent in its request.

Status Code and Reason Phrase

The *status code* and *reason phrase* provide information about the results of processing the client’s request in two different forms. The status code is a three-digit number that indicates the formal result that the server is communicating to the client; it is intended for the client HTTP implementation to process so the software can take appropriate action. The reason phrase is an additional, descriptive text string, which can be displayed to the human user of the HTTP client so he or she can see how the server responded. [I describe status codes and reason phrases later in this section](#), and also list all of the standard codes.

Headers

The response message will always include a number of headers that provide extra information about it. Response message headers fall into these categories:

-
- **General Headers:** General headers that refer to the message itself and are not specific to response messages or the entity in the message body. These are the same as the generic headers that can appear in request messages (though certain headers appear more often in responses and others are more common in requests).
 - **Response Headers:** These headers provide additional data that expands upon the summary result information in the status line. The server may also return extra result information in the body of the message, especially when an error occurs, as discussed below.
 - **Entity Headers:** These are headers that describe the entity contained in the body of the response, if any. These are the same entity headers that can appear in a request message, but they are seen more often in response messages. The reason for this is simply that responses more often carry an entity than requests, because most requests are to retrieve a resource.



Note: Entity headers may appear in a response to describe the resource that is the subject of the request, even if the entity itself is not sent in the message. This occurs when the *HEAD* method is used to request only the headers associated with an entity.

Response headers are of course used only in response messages, while the others are general with respect to message type. [See the section describing HTTP headers for more details.](#)

Most response messages contain an entity in the message body. In the case of a successful request to retrieve a resource, this is the resource itself. Responses indicating unsuccessful requests usually contain detailed error information, often in the form of an HTML-formatted error message.



Key Concept: Each HTTP request sent by a client leads to a server returning one or more *HTTP responses*. Each response message starts with a *status line* that contains the server's HTTP version number, and a numeric *status code* and text *reason phrase* that indicate the result of processing the client's request. The message then contains headers related to the response, followed by a blank line and then the optional message body. Since most HTTP requests ask for a server to return a file or other resource, many HTTP responses carry an entity in the message body.

HTTP Methods

A request sent by a client to a server obviously... requests that the server do something. All client/server protocols provide a way for the client to prompt the server to take action, generally by having the client give the server a series of commands. HTTP, in contrast, does not have commands but rather *methods*. Each client [request message](#) begins with the specification of the method that is the subject of the request.

What is the difference between a method and a command? In practical terms, nothing; they are the same. So why does HTTP use the term “method” instead of “command”? Good question. ☺ The answer can be found in the abstract of the standard defining HTTP/1.0, RFC 1945. It states, in part, that HTTP is:

“a generic, stateless, object-oriented protocol which can be used for many tasks...”

In highly simplified terms, object-oriented programming is a technique in which software modules are described not as sets of procedures but as *objects* that possess attributes. These modules send messages to each other to communicate, and to cause actions to be performed, where the action taken depends on the nature of the object. In object-oriented programming, the procedures each object can perform are called *methods*.

HTTP is considered to be object-oriented because in many cases, the action taken by a server depends on the object that is the subject of the request. For example, if you ask a server to retrieve a text document, it will send that document, but if you ask for a directory, the server may instead return a default document for that directory. In contrast, a request that specifies the name of a program will result in the program being executed and its output returned (as opposed to the program’s source code being returned.)

Common Methods

Each method allows the client to specify a particular type of action to be taken by the server. Method names are always in upper case letters. There are three methods that are commonly used in HTTP.

GET

The *GET* method requests that server retrieve the resource specified by the URL on the HTTP request line and send it in a response back to the client. This is the most basic type of request and the one that accounts for the majority of HTTP traffic. When you enter a conventional URL or click on a link to a document or other file, you are usually prompting your Web browser to send a *GET* request.

The handling of a *GET* request depends on a number of factors. If the URL is correct and the server can find the resource, it will of course send back the appropriate response to the client. As mentioned above, the exact resource returned depends on the nature of the object requested. If the request cannot be processed properly, an error message may result. [Caching](#) also comes into play, as a proxy server or even the client itself might satisfy the request before it gets to the server.

It’s important to remember that the meaning of a *GET* request may change if certain headers, such as *If-Modified-Since* or *If-Match* are used—these and other similar headers tell the server to only send the resource if certain conditions are met. A request of this sort is sometimes called a *conditional GET*. Similarly, the *Range* header may be used by the client to request that the server send it only part of a resource; this is usually used for large files. When this header is included, the request may be called a *partial GET*.

HEAD

This is identical to the *GET* method, but tells the server to not send the actual body of the message. Thus, the response will contain all of the headers that would have accompanied a reply to the equivalent *GET* message, including [entity headers](#) describing the entity that the server would have sent had the method been *GET*. This method is often used by the client to check the existence, status or size of a file before deciding whether or not it wants the server to send the whole thing.

HEAD requests are processed in the same way as *GET* requests, except that only the headers are returned, not the actual resource.

POST

This method allows the client to send an entity containing arbitrary data to the server for processing. It is commonly used to enable a client to submit information such as an interactive HTML form to a program on the server, which then takes action based on that input and sends a response. This capability is now used for all sorts of online programs. The URL in the request specifies the name of the program on the server that is to accept the data.

Contrast this with the *PUT* method below.

Other, Less-Common Methods

The other methods defined by the HTTP standard are not used as often, but I will describe them briefly, as you may still encounter them from time to time.

OPTIONS

Allows the client to request that the server send it information about available communication options. A URI of a resource may be specified to request information relevant to accessing that resource, or an asterisk (“*”) may be used to indicate that the query is about the server itself. The response includes headers that give the client more details about how the server may be accessed.

PUT

Requests that the server store the entity enclosed in the body of the request at the URL specified in the request line. The difference between a *PUT* and a *POST* is that in a *PUT*, the URI identifies the entity in the request, while in a *POST*, the URI identifies a program intended to **process** the entity in the request. Thus a *PUT* would be used to allow a file to be copied to a server, in the exact complement to how a *GET* requests that a file be copied to the client. A *POST* is used for interactive programs, as explained above.

Now, would you like people to be able to store files on your server in the same way that they request them? Neither would I. This is one primary reason why *PUT* is not often used. It has valid uses, such as uploading content to a Web site, and must be used with authentication in this case. However, generally speaking, storing files on a site is more often accomplished using other means, like FTP.

DELETE

Requests that the specified resource be deleted. This has the same issues as *PUT* and is not often used for similar reasons.

TRACE

Allows a client to receive back a copy of the request that it itself sent to the server, for diagnostic purposes.



Note: In addition to the methods described above, the HTTP standard reserves the method name *CONNECT* for future use. An earlier version of HTTP/1.1, RFC 2068, also defined the methods *PATCH*, *LINK* and *UNLINK*. These were removed in the final version but reference to them is still sometimes seen.



Key Concept: Each HTTP client request specifies a particular type of action that the server perform; in HTTP, these are called not commands but rather *methods*. The three most common HTTP methods are *GET*, which prompts a server to return a resource; *HEAD*, which returns just the headers associated with a resource; and *PUT*, which allows a client to submit data to a server for processing.

"Safe" and Idempotent Method Categorizations

As we've seen above, methods vary greatly in the type of behavior they cause the server to take. The HTTP standard defines two characteristics that can be used to differentiate methods based on the impact they have on a server:

- ☉ **"Safe" Methods:** These are methods that an administrator of a server can feel reasonably comfortable permitting a client to send because they are very unlikely to have any negative "side-effects". The methods usually put into this category are *GET*, *HEAD*, *OPTIONS* and *TRACE*. The methods that cause data to be accepted by the server for processing, or lead to changes on the server, are deemed "unsafe": *POST*, *PUT*, and *DELETE*. (The fact that they are "unsafe" doesn't mean a server never allows them, just that they require more care and detail in handling than the others.)
- ☉ **Idempotent Methods:** Woah, 10-dollar word time. ☺ A method is said to be *idempotent* if repeating the same method request numerous times causes the exact same results as if the method were issued only once. For example, if you load a Web page in your browser, and then type the same URL in again, you get the same result, at least most of the time. In general, all of the methods in HTTP have this property inherently except one: *POST*.

The *POST* method is not idempotent because each instance of a *POST* request causes the receiving server to process the data in the request's body. Submitting a *POST* request two or more times can often lead to undesirable results. The classic example is hitting the “submit” button on a form more than once, which can lead to annoyances such as a duplicate message on an Internet forum, or even a double order at an online store.

There are also situations where a method that is normally idempotent may not be. A *GET* request for a simple document is idempotent, but a *GET* for a script can change files on the server and therefore is not idempotent. Similarly, a sequence of idempotent methods can be non-idempotent. For example, consider a situation where a *PUT* request is followed by a *GET* for the same resource. This sequence is non-idempotent because the second request depends on the results of the first.

The significance of non-idempotence is that clients must handle such requests or sequences specially. The client must keep track of them, and make sure that they are filled in order and only once. The HTTP standard also specifies that non-idempotent methods should not be pipelined, to avoid problems if an HTTP session is unexpectedly terminated. For example, if two *POST* requests were pipelined and the server got hung up handling them, the client would need to reissue them but might not know how many of the originals had been successfully processed.

HTTP Status Code Format. Status Codes and Reason Phrases

Every request sent by an HTTP client causes one (or more) responses to be returned by the server that receives it. As we saw in [the topic describing the response message format](#), the first line of the response is a status line that contains a summary of the results of processing the request. The purpose of this line is to communicate quickly whether or not the request was successful, and why.

HTTP status lines contain both a numeric *status code* and a text *reason phrase*. The idea behind this was taken directly from earlier application layer protocols such as [FTP](#), [SMTP](#) and [NNTP](#). The reason for having both a number and a text string is that computers can more easily “understand” the results of a request by looking at a number, and can then quickly respond accordingly. Humans, on the other hand, find numbers cryptic and text descriptions easier to comprehend. ([The topic on FTP reply codes](#) discusses more completely the reasons why numeric reply codes are used in addition to descriptive text.)

Status Code Format

HTTP status codes are three digits in length and follow a particular format where the first digit has particular significance. Unlike FTP and the others, the second digit does not stand for a functional grouping; the second and third digits together just make 100 different options for each of the categories indicated by the first digit. Thus, the general form of an HTTP status code is “xyy”, where the first digit, “x”, is specified as given in [Table 275](#).

Table 275: HTTP Status Code Format: First Digit Interpretation

Status Code Format	Meaning	Description
1yy	Informational Message	Provides general information; does not indicate success or failure of a request.
2yy	Success	The method was received, understood and accepted by the server.
3yy	Redirection	The request did not fail outright, but additional action is needed before it can be successfully completed.
4yy	Client Error	The request was invalid, contained bad syntax or could not be completed for some other reason that the server believes was the client's fault.
5yy	Server Error	The request was valid but the server was unable to complete it due to a problem of its own.

In each of these five groups, the code where “yy” is “00” is defined as a “generic” status code for that group, while other two-digit combinations are more specific responses. For example, “404” is the well-known specific error message that means the requested resource was not found by the server, while “400” is the less specific “bad request” error. This system was set up to allow the definition of new status codes that certain clients might not comprehend. If a client receives a strange code, it just treats it as the equivalent of the generic response in the appropriate category. So if a server response starts with the code “491” and the client has no idea what this is, it just treats it as a 400 “bad request” reply.

Reason Phrases

The reason phrase is a text string that provides a more meaningful description of the error for people who are bad at remembering what cryptic codes stand for (which would be most of us!) The HTTP standard includes “sample” reason phrases for each status code, but these can be customized by the administrators of a server if desired. When a server returns a more detailed HTML error message in the body of its response message, the reason phrase is often used for the “title” tag in that message body.



Key Concept: Each HTTP response includes both a numeric *status code* and a text *reason phrase*, both of which indicate the disposition of the corresponding client request. The numeric code allows software programs to easily interpret the results of a request, while the text phrase provides more useful information to human users. HTTP status codes are three digits in length, with the first digit indicating the general class of the reply.

Status Codes and Reason Phrases

Table 276 lists in numerical order the status codes defined by the HTTP/1.1 standard, along with the “standard” reason phrase and a brief description of each:

Table 276: HTTP Status Codes (Page 1 of 4)

Status Code	Reason Phrase	Description
100	Continue	Client should continue sending its request. This is a special status code; see below for details.
101	Switching Protocols	The client has used the <i>Upgrade</i> header to request the use of an alternative protocol and the server has agreed.
200	OK	Generic successful request message response. This is the code sent most often when a request is filled normally.
201	Created	The request was successful and resulted in a resource being created. This would be a typical response to a <i>PUT</i> method.
202	Accepted	The request was accepted by the server but has not yet been processed. This is an intentionally “non-committal” response that does not tell the client whether or not the request will be carried out; the client determines the eventual disposition of the request in some unspecified way. It is used only in special circumstances.
203	Non-Authoritative Information	The request was successful, but some of the information returned by the server came not from the original server associated with the resource but from a third party.
204	No Content	The request was successful, but the server has determined that it does not need to return to the client an entity body.
205	Reset Content	The request was successful; the server is telling the client that it should reset the document from which the request was generated so that a duplicate request is not sent. This code is intended for use with forms.
206	Partial Content	The server has successfully fulfilled a partial GET request. See the topic on methods for more details on this, as well as the description of the Range header .
300	Multiple Choices	The resource is represented in more than one way on the server. The server is returning information describing these representations, so the client can pick the most appropriate one, a process called agent-driven negotiation .

Table 276: HTTP Status Codes (Page 2 of 4)

Status Code	Reason Phrase	Description
301	Moved Permanently	The resource requested has been moved to a new URL permanently. Any future requests for this resource should use the new URL. This is the proper method of handling situations where a file on a server is renamed or moved to a new directory. Most people don't bother setting this up, which is why URLs "break" so often, resulting in 404 errors as discussed below.
302	Found	The resource requested is temporarily using a different URL. The client should continue to use the original URL. See code 307.
303	See Other	The response for the request can be found at a different URL, which the server specifies. The client must do a fresh <i>GET</i> on that URL to see the results of the prior request.
304	Not Modified	The client sent a conditional <i>GET</i> request, but the resource has not been modified since the specified date/time, so the server has not sent it.
305	Use Proxy	To access the requested resource, the client must use a proxy, whose URL is given by the server in its response.
306	(unused)	Defined in an earlier (draft?) version of HTTP and no longer used.
307	Temporary Redirect	The resource is temporarily located at a different URL than the one the client specified. Note that 302 and 307 are basically the same status code. 307 was created to clear up some confusion related to 302 that occurred in earlier versions of HTTP (which I'd rather not get into!)
400	Bad Request	Server says, "huh?" ☹️ Generic response when the request cannot be understood or carried out due to a problem on the client's end.
401	Unauthorized	The client is not authorized to access the resource. Often returned if an attempt is made to access a resource protected by a password or some other means without the appropriate credentials.
402	Payment Required	This is reserved for future use. Its mere presence in the HTTP standard has caused a lot of people to scratch their chins and go "hmm..." ☹️
403	Forbidden	The request has been disallowed by the server. This is a generic "no way" response that is not related to authorization. For example, if the maintainer of Web site blocks access to it from a particular client, any requests from that client will result in a 403 reply.
404	Not Found	The most common HTTP error message, returned when the server cannot locate the requested resource. Usually occurs due to either the server having moved/removed the resource, or the client giving an invalid URL (misspellings being the most common cause.)
405	Method Not Allowed	The requested method is not allowed for the specified resource. The response includes an <i>Allow</i> header that indicates what methods the server will permit.

Table 276: HTTP Status Codes (Page 3 of 4)

Status Code	Reason Phrase	Description
406	Not Acceptable	The client sent a request that specifies limitations that the server cannot meet for the specified resource. This error may occur if an overly-restrictive list of conditions is placed into a request such that the server cannot return any part of the resource.
407	Proxy Authentication Required	Similar to 401, but the client must first authenticate itself with the proxy .
408	Request Timeout	The server was expecting the client to send a request within a particular time frame and the client didn't send it.
409	Conflict	The request could not be filled because of a conflict of some sort related to the resource. This most often occurs in response to a <i>PUT</i> method, such as if one user tries to <i>PUT</i> a resource that another user has open for editing, for example.
410	Gone	The resource is no longer available at the server, which does not know its new URL. This is a more specific version of the 404 code that is used only if the server knows that the resource was intentionally removed. It is seen rarely (if ever) compared to 404.
411	Length Required	The request requires a Content-Length header field and one was not included.
412	Precondition Failed	Indicates that the client specified a precondition in its request, such as the use of an <i>If-Match</i> header, which evaluated to a false value. This indicates that the condition was not satisfied so the request is not being filled. This is used by clients in special cases to ensure that they do not accidentally receive the wrong resource.
413	Request Entity Too Large	The server has refused to fulfill the request because the entity that the client is requesting is too large.
414	Request-URI Too Long	The server has refused to fulfill the request because the URL specified is longer than the server can process. This rarely occurs with properly-formed URLs but may be seen if clients try to send gibberish to the server.
415	Unsupported Media Type	The request cannot be processed because it contains an entity using a media type the server does not support.
416	Requested Range Not Satisfiable	The client included a <i>Range</i> header specifying a range of values that is not valid for the resource. An example might be requesting bytes 3,000 through 4,000 of a 2,400-byte file.
417	Expectation Failed	The request included an <i>Expect</i> header that could not be satisfied by the server.
500	Internal Server Error	Generic error message indicating that the request could not be fulfilled due to a server problem.
501	Not Implemented	The server does not know how to carry out the request, so it cannot satisfy it.
502	Bad Gateway	The server, while acting as a gateway or proxy, received an invalid response from another server it tried to access on the client's behalf.

Table 276: HTTP Status Codes (Page 4 of 4)

Status Code	Reason Phrase	Description
503	Service Unavailable	The server is temporarily unable to fulfill the request for internal reasons. This is often returned when a server is overloaded or down for maintenance.
504	Gateway Timeout	The server, while acting as a gateway or proxy, timed out while waiting for a response from another server it tried to access on the client's behalf.
505	HTTP Version Not Supported	The request used a version of HTTP that the server does not understand.

The 100 (Continue) Preliminary Reply

Phew. Now, let's go back to the top, status code 100. Normally, a client sends a complete request to the server, and waits for a response to it (while optionally [pipelining additional requests](#)). In certain circumstances, however, the client might wish to check in advance if the server is willing to accept the request before it bothers sending the whole message. This is not a common occurrence, because most requests are quite small, which makes it not worth the bother. However, in cases where a user wants to submit a very large amount of data to an online program, or use *PUT* to store a large file, for example, checking with the server first can be a useful optimization.

In this situation, the client sends a request containing the special header “*Expect: 100-continue*”. Assuming that the server supports the feature, it will process the request's headers and immediately send back the “*100 Continue*” preliminary reply. This tells the client to continue sending the rest of the request. The server then processes it and responds normally. If the server doesn't send the 100 response after a certain amount of time, the client will typically just send the rest of the request anyway.



Note: In some cases, servers send these preliminary replies even when they are not supposed to, so clients must be prepared to deal with them (they are simply discarded, since they contain no information).



HTTP Message Headers

HTTP communication takes place through the relatively simple [exchange of request and response messages](#). There are only a small number of [methods \(commands\)](#) supported by the protocol, which might give one the impression that the protocol is quite limited. Looks can be deceiving, however. Much of the functionality in HTTP is actually implemented in the form of *message headers*, which convey important details between clients and servers.

Some headers can appear in only [HTTP requests](#), some in only [HTTP responses](#), and some in either type of message. Since they are so important, there are literally dozens of them, and many apply to both requests and responses, I decided to describe them in detail in a separate section rather than try to summarize them too much in the course of describing the message formats

In this section I provide a description of each of the many headers used in HTTP request and response messages. The section contains four topics, each of which covers one of the four basic types of HTTP headers: general headers, request headers, response headers and entity headers.



Background Information: I assume here that you have already read [the preceding section describing HTTP message formats](#).



Note: For the purpose of determining how Web caches treat HTTP messages, HTTP headers are categorized as either *end-to-end* or *hop-by-hop* headers. The former are meaningful only to the ultimate recipient of a message, while the latter are relevant to each device in the [chain of devices](#) (such as [proxies](#)) connecting a client and server. To avoid unnecessary complication I have not categorized the headers in this section using these categories; [see the topic on caching](#) for more information. In the descriptions of the individual headers, I indicate which headers are hop-by-hop; all others are end-to-end.

HTTP General Headers

HTTP *general headers* are so named because unlike the other three categories, they are not specific to any particular kind of message or message component (request, response or message entity). General headers are used primarily to communicate information about the message itself, as opposed to what content it carries. They provide general information and control how a message is processed and handled.

Despite not being specific to either requests or replies, some general headers are used either mostly or entirely in one or the other type of message. There are also some general headers that can appear in either a request or a reply, but have a somewhat different meaning in each.

Cache-Control

Specifies directives that manage how caching is performed either for an HTTP request or response. These directives affect the handling of a request or response by all devices in the [request/response chain](#) from the HTTP client, through any present intermediaries, to the HTTP server (or the other way, from the server, through intermediaries, to the client). They override any default caching behavior performed by a device. [See the topic on caching for a full exposition of the subject.](#)

There are a dozen individual directives that can appear in this header, the full details of which can be found in RFC 2616. Even though this is a general header, some directives can appear only in a request or a response. Some also include an additional parameter, such as a number of seconds, that control their interpretation. [Table 277](#) provides a brief summary of the different *Cache-Control* options and how they are used.

Note that only one directive may appear in a *Cache-Control* header, but more than one such header can appear in a message.

Table 277: HTTP Cache-Control Directives (Page 1 of 2)

Cache-Control Directive	HTTP Message Type	Description
<i>no-cache</i>	<i>Request or Response</i>	When present, forces a caching device to forward any subsequent requests for the same content to the server for revalidation. That is, the cache must check with the server to ensure that the cached data is still valid. Also see the <i>Pragma</i> header description, for an alternative way of accomplishing the same thing.
<i>public</i>	<i>Response</i>	Indicates that the response may be cached by any cache, including a shared one (a cache used by many clients). See the topic on caching for more details on shared caches.
<i>private</i>	<i>Response</i>	Specifies that the response is intended for only a particular user and should not be placed into a shared cache.
<i>no-store</i>	<i>Request or Response</i>	Specifies that the entire request or response should not be stored in a cache. This is used sometimes to prevent the storing of sensitive documents in caches where unauthorized people might be able to access them. However, as the HTTP standard points out, this is really a very rudimentary security measure and should not be trusted a great deal (since a malicious cache operator could simply ignore the directive.)
<i>max-age</i>	<i>Request or Response</i>	In a request, indicates that the client is willing to accept a response whose age is no greater than the value specified. In a response, indicates the maximum age of the response before it is considered “stale”—this is an alternative to the use of the <i>Expires</i> header and takes precedence over it.

Table 277: HTTP Cache-Control Directives (Page 2 of 2)

Cache-Control Directive	HTTP Message Type	Description
s-maxage	<i>Response</i>	If present, this directive specifies the maximum age for shared caches receiving the response. Private caches (ones that serve only a single client) use the <i>max-age</i> value described just above.
min-fresh	<i>Request</i>	Specifies that the client wants a response that is not only not stale at the time the request is received, but that will remain “fresh” for the specified number of seconds.
max-stale	<i>Request</i>	If sent without a parameter, indicates that the client is willing to accept a stale reply (one that has expired). If a numeric parameter is included, it indicates how stale, in seconds, the response may be.
only-if-cached	<i>Request</i>	Used only in special circumstances, this directive forces the reply to come from a cache only; the content may not come from the actual specified HTTP server.
must-revalidate	<i>Response</i>	Instructs a cache to revalidate its cache entry for the given response with the original server after it becomes stale. This is used to prevent problems with certain types of transactions that can occur if stale cache entries are sent to a client (perhaps as a result of the client using the <i>max-stale</i> directive.)
proxy-revalidate	<i>Response</i>	Similar to <i>must-revalidate</i> , but applies only to proxies that service many users. Private caches, such as those on individual client computers, are not affected.
no-transform	<i>Request or Response</i>	Some caches will, by default, change the form in which certain cached entries are stored, to save space or improve performance. In cases where this might cause problems, the client or server can use this directive to request that this transformation not be performed.

Connection

Contains instructions that pertain only to this particular connection, and must not be retained by proxies and used for further connections. The most common use of this header is with the parameter “close”, as follows:

Connection: close

This overrides the default [persistent connection](#) behavior of HTTP/1.1, forcing the connection to terminate after the server's response. *Connection* is a hop-by-hop header.

Date

Indicates the date and time when the message originated. This is the same as the *Date* header in the [RFC 822 e-mail format](#). A typical example would be:

Date: Wed, 06 Aug 2003 16:43:50 GMT

Pragma

Used to enable implementation-specific directives to be applied to all devices in the request/response chain. One common use of this header is to suppress caching by including “*Pragma: no-cache*” in a message. This has the same meaning as a “*Cache-Control: no-cache*” header, and is included in HTTP/1.1 for backward compatibility with HTTP/1.0 (which supports *Pragma* but not *Cache-Control*).

Trailer

When “[chunked](#)” transfers are used, certain headers may be placed as trailers, after the data being sent. In this case, the *Trailer* header is included before the data, and lists the names of the headers that are actually trailers in that message. This warns the recipient to look for them after the data. *Trailer* is a hop-by-hop header.

Transfer-Encoding

Indicates what encoding has been used for the body of the message, to ensure that it is able to be transferred properly between devices. This header is most often used with the “[chunked](#)” transfer method. Note that this header describes encoding applied to an entire message, and is thus not the same as the *Content-Encoding* [entity header](#), which specifically describes the entity carried in a message. [See the topic on content and transfer encodings](#) for a full discussion. This header applies only to a single transfer, so it is a hop-by-hop header.

Upgrade

Allows a client device to specify what additional protocols it supports. If the server also supports one of the protocols the client listed, the server may agree to “upgrade” the connection to the alternative protocol. It indicates the protocol to which it is upgrading by including an *Upgrade* header in a 101 (“*Switching Protocols*”) response to the client. This is a hop-by-hop header.

Via

Included by intermediary devices to indicate to the recipient what gateways, proxies and/or tunnels were used in conveying a request or response. This header allows easy tracing of the path a message took over a potentially complex chain of devices between a client and server.

Warning

Used when needed to provide additional information about the status of a message. Many of the defined warning header types are related to caching. More than one *Warning* header may appear in a message, and each typically includes a three-digit numeric code as well as a plain text message—the same basic format used in [HTTP response status codes](#).

Table 278 briefly lists the warnings defined in RFC 2616.

Table 278: HTTP Warning Header Codes

Warning Code	Warning Text	Description
110	Response is stale	Must be included when a response provided by a cache is stale (that is, has passed the expiration time set for it.)
111	Revalidation failed	A cache attempted to revalidate a cached entry but was unsuccessful, so it returned its (stale) cached entry.
112	Disconnected operation	The cache is disconnected from the rest of the network.
113	Heuristic expiration	Included if the cache chose a freshness lifetime of more than 24 hours, and the age of the response is also greater than 24 hours.
199	Miscellaneous warning	Catch-all code for other, non-specific warnings.
214	Transformation applied	Warns the recipient that an intermediate cache or proxy applied a transformation of some type to change the content coding or media type of the message or message body.
299	Miscellaneous persistent warning	Similar to code 199 but indicates a persistent warning.



Key Concept: HTTP *general headers* can appear in either an *HTTP Request* or *HTTP Response* message. They are used to communicate information about the message itself, as opposed to its contents. General headers are used for functions such as specifying the date and time of a message, controlling how the message is cached, and indicating its transfer encoding method.

HTTP Request Headers

HTTP *request headers*, as you might imagine, are used only in HTTP [request messages](#), and serve a number of functions in them. First, they allow the client to provide information about itself to the server. Second, they give additional details about the nature of the request that the client is making. Third, they allow the client to have greater control over how its request is processed and how (or even if) a response is returned by the server or intermediary.

This is the largest of the four categories of HTTP headers, comprising over a dozen different types.

Accept

Allows the client to tell the server what Internet media types it is willing to accept in a response. The header may list several different MIME media types and subtypes that the client knows how to deal with. Each may be prepended with a “quality value” (“q”

parameter) to indicate the client's preference. If this header is not specified, the default is for the server to assume any media type may be sent to the client. See the topics on [entity media types](#) and [content negotiation](#) for more information on how this header is used.

Accept-Charset

Similar to *Accept*, but specifies what character sets the client is willing to accept in a response, rather than what media types. Again, the listed charsets may use a “q” value, and again, the default if the header is omitted is for the client to accept any character set.

Accept-Encoding

Similar to *Accept* and *Accept-Charset*, but specifies what content encodings the client is willing to accept. This is often used to control whether or not the server may send content in compressed form. (Remember that [content codings are not the same as transfer encodings](#).)

Accept-Language

Similar to the preceding *Accept*-type headers, but provides a list of *language tags* that indicate what languages the client supports or expects the server to use in its response.

Authorization

Used by the client to present authentication information (called “credentials”) to the server to allow the client to be authenticated. This is required only when the server requests authentication, often by sending a 401 (“*Unauthorized*”) response to the client's initial request. This response will contain a *WWW-Authenticate* header providing the client with details on how to authenticate with the server. [See the topic on security and privacy](#).

Expect

Indicates certain types of actions that the client is expecting the server to perform. Usually the server will accept the indicated parameters; if not, it will send back a 417 (“*Expectation Failed*”) response. The most common use of this field is to control when the server sends a 100 (“*Continue*”) response. The client indicates that it wants the server to send this preliminary reply by including the “*Expect: 100-continue*” header in its request. ([See the end of the topic on status codes](#) for details.)

From

Contains the e-mail address of the human user making the request. This is optional, and since it is easily spoofed, should be used only for informational purposes, and not for any type of access rights determination or authentication.

Host

Specifies the Internet host as a [DNS domain name](#), and may also contain a port number specification as well (typically, only if a port other than the HTTP default of 80 is to be used). This header is used to allow multiple domains to be served by the same Web server on a particular IP host. It has the distinction of being the only **mandatory** header—it must be present in all HTTP/1.1 requests.

If-Match

Makes a method conditional by specifying the *entity tag* (or tags) corresponding to the specific entity that the client wishes to access. This is usually used in a *GET* method, and the server responds with the entity only if it matches the one specified in this header. Otherwise, a 412 (“*Precondition Failed*”) reply is sent.

If-Modified-Since

Makes a method conditional by telling the server to return the requested entity only if it has been modified since the time specified in this header. Otherwise, the server sends a 304 (“*Not Modified*”) response. This is used to check if a resource has changed since it was last accessed, to avoid unnecessary transfers.

If-None-Match

This is the opposite of *If-Match*; it creates a conditional request that is only filled if the specified tag(s) do **not** match the requested entity.

If-Range

This header is used in combination with the *Range* header to effectively allow a client to both check for whether an entity has changed and request that a portion of it be sent in a single request. (The alternative is to first issue a conditional request, which if it fails would then require a second request.) When present, *If-Range* tells the server to send to the client the part of the entity indicated in the *Range* header if the entity has not changed. If the entity **has** changed, the entire entity is sent in response.

If-Unmodified-Since

The logical opposite of the *If-Modified-Since* header; the request is filled only if the resource has **not** been modified since the specified time; otherwise a 412 reply is sent.

Max-Forwards

Specifies a limit on the number of times a request can be forwarded to the next device in the request chain. This header is used with the *TRACE* or *OPTIONS* methods only, to permit diagnosis of forwarding failures or looping. When present in one of these methods, each time a device forwards the request, the number in this header is decremented. If a device

receives a request with a *Max-Forwards* value of 0, it must not forward it but rather respond back to the client. (In a way, this is somewhat analogous to how the *Time To Live* field is used in the [Internet Protocol datagram format](#).)

Proxy-Authorization

This is like the *Authorization* header, but is used to present credentials to a [proxy server](#) for authentication, rather than the end server. It is created using information sent by a proxy in a response containing a *Proxy-Authenticate* header. This is a hop-by-hop header, sent only to the first proxy that receives the request. If authentication is required with more than one proxy, multiple *Proxy-Authorization* headers may be put in a message, with each proxy in turn “consuming” one of the headers.

Range

Allows the client to request that the server send it only a portion of an entity, by specifying a range of bytes in the entity to be retrieved. If the requested range is valid, the server sends only the indicated part of the file, using a 206 (“*Partial Content*”) status code; if the range requested cannot be filled, the reply is 416 (“*Requested Range Not Satisfiable*”).

Referer [sic]

Tells the server the URL of the resource from which the URL of the current request was obtained. Typically, when a user clicks a link on one Web page to load another, the address of the original Web page is put into the *Referer* line when the request for the clicked link is sent. This allows tracking and logging of how the server is accessed. If a human user manually enters a URI into a Web browser, this header is not included in the request. Since this header provides information related to how Web pages are used, it has certain [privacy implications](#).

The proper spelling of this word is “referrer”. It was misspelled years ago in an earlier version of the HTTP standard, and before this was noticed and corrected, became incorporated into so much software that the IETF chose not to correct the spelling in HTTP/1.1.

TE

Provides information to the server about how the client wishes to deal with transfer encodings for entities sent by the server. If extensions to the standard HTTP transfer encodings are defined, the client can indicate its willingness to accept them in this header. The header “*TE: trailers*” can also be used by the client to indicate its ability to handle having headers sent as trailers following data when “[chunking](#)” of data is done. This is a hop-by-hop header and applies only to the immediate connection.

User-Agent

Provides information about the client software. This is normally the name and version number of the Web browser or other program sending the request. It is used for server access statistic logging and also may be used to tailor how the server responds to the needs of different clients. Note that proxies do not modify this field when forwarding a request; rather, they use the *Via* header.



Key Concept: HTTP *request headers* are used only in *HTTP Request* messages. They allow a client to provide information about itself to a server, and provide more details about a request and control over how it is carried out.

HTTP Response Headers

The counterpart to [request headers](#), *response headers* appear only in [HTTP responses](#) sent by servers or intermediaries. They provide additional data that expands upon the summary information that is present in the status line at the beginning of each server reply. Many of the response headers are sent only in response to the receipt of specific types of requests, or even particular headers within certain requests.

There are nine response headers defined for HTTP/1.1.

Accept-Ranges

Tells the client whether or not the server accepts partial content requests using the *Range* request header, and if so, what type. Typical examples include “*Accept-Range: bytes*” if the server accepts byte ranges, or “*Accept-Range: none*” if range requests are not supported.

Note that this header is different from the other “Accept-” headers, which are used in [HTTP requests](#) to perform [content negotiation](#).

Age

Tells the client the approximate age of the resource, as calculated by the device sending the response.

ETag

Specifies the entity tag for the entity included in the response. This value can be used by the client in future requests to uniquely identify an entity, using the *If-Match* request header or similar.

Location

Indicates a new URL that the server is instructing the client to use in place of the one the client initially requested. This header is normally used when the server redirects a client request to a new location, using a 301, 302 or 307 reply. It is also used to indicate the location of a created resource in a 201 (“Created”) response to a *PUT* request.

Note that this is not the same as the *Content-Location* [entity header](#), which is used to indicate the location of the originally-requested resource.

Proxy-Authenticate

This is the proxy version of the *WWW-Authenticate* header (see below). It is included in a 407 (“*Proxy Authentication Required*”) response, to indicate how the proxy is requiring the client to perform authentication. The header specifies an authentication method as well as any other parameters needed for authentication. The client will use this to generate a new request containing a *Proxy-Authorization* header. This is a hop-by-hop header.

Retry-After

This header is sometimes included in unsuccessful requests—such as those resulting in a 503 (“*Service Unavailable*”) response—to tell the client when it should try its request again. It may also be used with a redirection response such as 301, 302 or 307, to indicate how long the client should wait before sending a request for the redirected URL. The *Retry-After* header may specify either a time interval to wait (in seconds) or a full date/time when the server suggests the client try again.

Server

This is the server's version of the *User-Agent* [request header](#); it identifies the type and version of the server software generating the response. Note that proxies do not modify this field when forwarding a response; they put their identification information into a *Via* header instead.

Vary

Specifies which request header fields fully determine whether a cache is allowed to use this response to reply to subsequent requests for the same resource without revalidation. A caching device inspects the *Vary* header to determine which other headers it needs to examine to determine whether or not it can respond with a cached entry, when the client makes its next request for the resource in this reply. Yeah, this one's a bit confusing.

WWW-Authenticate

This header is included in a 401 (“*Unauthorized*”) response, to indicate how the server wants the client to authenticate. The header specifies an authentication method as well as any other parameters needed for authentication. The client will use this to generate a new request containing an *Authorization* header.



Key Concept: HTTP *response headers* appear in *HTTP Response* messages, where they provide additional information about HTTP server capabilities and requirements, and the results of processing a client request.

HTTP Entity Headers

Last but not least, we come to the fourth group of HTTP headers: *entity headers*. These headers provide information about the resource carried in the body of an HTTP message, called an *entity* in the HTTP standards. They serve the overall purpose of conveying to the recipient of a message the information it needs to properly process and display the entity, such as its type and encoding method.

The most common type of entity is a file or other set of information that has been requested by a client, and for this reason, entity headers most often appear in HTTP responses. However, they can also appear in HTTP requests, especially those using the *PUT* and *POST* methods, which are the ones that transfer data from a client to a server.

At least one entity header should appear in any HTTP message that carries an entity. However, they may also be present in certain responses that do not have an actual entity in them. Most notably, a response to a *HEAD* request will contain all the entity headers associated with the resource specified in the request; these are the same headers that would have been included with the entity, had the *GET* method been used instead of *HEAD* on the same resource. Entity headers may also be present in certain error responses, to provide information to help the client make a successful follow-up request.



Note: Many of the entity headers have the same names as certain MIME headers, but they are often used in different ways. [See the topic on HTTP Internet media types](#) for a full discussion of the relationship between HTTP and MIME.

The following are the entity headers defined in HTTP/1.1:

Allow

Lists all the [methods](#) that are supported for a particular resource. This header may be provided in a server response as a guide to the client regarding what methods it may use on the resource in the future. The header **must** be included when a server returns a 405 (“*Method Not Allowed*”) response to a request containing an unsupported method.

Content-Encoding

Describes any optional method that may have been used to encode the entity. This header is most often used when transferring entities that have been compressed; it tells the recipient what algorithm has been used so the entity can be uncompressed. Note that this

header only describes transformations performed on the entity in a message; the *Transfer-Encoding* header describes encodings done on the message as a whole. [See the topic on content codings and transfer codings](#) for more details.

Content-Language

Specifies the natural (human) language intended for using the entity. This is an optional header, and may not be appropriate for all resource types. Multiple languages may be specified, if needed.

This header is intended to provide guidance so the entity can be presented to the correct audience; thus, the language should be selected based on who would best use the material, which may not necessarily include all of the languages used in the entity. For example, a German analysis of Italian operas would probably best tagged only with the language “de”. (They do have German analyses of Italian operas, don’t they? ☺)

Content-Length

Indicates the size of the entity in octets. This header is important, as it is used by the recipient to determine the end of a message. However, it may only be included in cases where the length of a message can be fully determined prior to transmitting the entity. This is not always possible in the case of dynamically-generated content, which complicates message length calculation; [the discussion of data length and the “chunked” transfer encoding](#) contains a full exploration of this issue.

Content-Location

Specifies the resource location of the entity, in the form of an absolute or relative uniform resource locator (URL). This is an optional header, and is normally included only in cases where the entity has been supplied from a location different from the one specified in the request. This may occur if a particular resource is stored in multiple places.

Content-MD5

Contains an MD5 digest for the entity, used for message integrity checking.

Content-Range

Sent when a message contains an entity that is only part of a complete resource; for example, a fragment of a file sent in response to an HTTP *GET* request containing the *Range* header. The *Content-Range* header indicates what portion of the overall file this message contains, as well as the total size of the resource. This information is given as a byte range, with the first byte numbered 0; for example, if the entity contains the first 1,200 bytes of a 2,000-byte file, this header would have a value of “0-1199/2000”.

Content-Type

Specifies the media type and subtype of the entity, in a manner very similar to [how this header is used in MIME](#). See the topic describing [HTTP entities and Internet media types](#) for a full discussion.

Expires

Specifies a date and time after which the entity in the message should be considered “stale”. This may be used to identify certain entities that should be held in HTTP caches for longer or shorter periods of time than usual.

This header is ignored if a *Cache-Control* header containing the “max-age” directive is present in the message.

Last-Modified

Indicates the date and time when the server believes the entity was last changed. This header is often used to determine if a resource has been modified since it was last retrieved. For example, suppose a client machine already contains a copy of a very large file that was obtained two months ago, and its user wants to check if an update to the file is available. The client can send a *HEAD* request for the file, and compare the value of the returned *Last-Modified* header to the date of the copy of the file it already has. Then it needs only to request the entire file if it has changed.

Note the use of the word “believe” in the description above. The reason for this wording is that the server cannot always be certain of the time that a resource was modified. With files this is fairly simple—it is usually the last-modified time stored for the file by the operating system. For other more complex resources such as database records or virtual objects, however, it may be more difficult to ascertain when the last change occurred to a particular piece of information. In the case of dynamically-generated content, the *Last-Modified* date/time may be the same as that of the message as a whole, as specified in the *Date* field.



Key Concept: HTTP *entity headers* appear in either request or response messages that carry an entity in the message body. They describe the nature of the entity, including its type, language and encoding, to facilitate the proper processing and presentation of the entity by the device receiving it.



HTTP Entities, Transfers, Coding Methods and Content Management

[HTTP message headers](#) are very important, because they are the mechanism that HTTP uses to allow devices to specify the details of client requests and server responses. These headers, however, are only the means to an end, which is the transfer of resources such as files, form input and program output from one device to another. When a resource is carried in the body of an HTTP message, it is called an *entity*. HTTP defines special rules for how these entities are identified, encoded and transferred.

In this section, I take a detailed look at how HTTP handles entities. I begin with a discussion of entities in general terms, and a look at how their contents are identified; this includes an examination of the relationship between HTTP and MIME. I discuss the issues behind the transfer of entities between clients and servers, and the difference between content encodings and transfer encodings. I describe the special issues associated with identifying the length of entities in HTTP messages, and detail the special “chunked” transfer coding and message trailers. Finally, I describe the methods by which devices can perform content negotiation, and how quality values allow clients to intelligently select different variations of a resource.

HTTP Entities and Internet Media Types

The presence of the word “text” in the name “Hypertext Transfer Protocol” is a reminder of the legacy of HTTP. As I explained in my [brief history of the World Wide Web](#), it was originally created to allow text documents to be linked together. This made sense, because at the time that the Web was being created, most computing was still being done with text. Accordingly, the first version of HTTP (HTTP/0.9) supported only one type of message body: a plain ASCII text document.

In the early 1990s, the rapid increase in computing power and networking performance transformed the world of information technology from text to multimedia. These were also the World Wide Web’s formative years, and it did not take long before many users wanted to exploit the power of the Web to share not only text files but also pictures, drawings, sound clips, movies and much more. Thus, HTTP had to evolve as well; starting with HTTP/1.0, significant changes were made to allow the protocol to transport and process much more than just text. Today, HTTP really would be better described as dealing with *hyper-media* than hypertext, though the name of the protocol was never changed.

One drawback of supporting many types of files in HTTP is added complexity. Where before every message recipient knew the body contained ASCII text, now any message can contain any of many kinds of data. When HTTP was expanded to support flexible media, it needed a system that would address two specific issues: encoding entities of various types into an HTTP message body, and clearly identifying the entity’s characteristics for the recipient of the message.

At the same time that HTTP was being changed to support non-text entities, another important TCP/IP application was also moving away from its decades-long role as a text-messaging medium, to one that could transport multimedia: [electronic mail](#). This was accomplished using a technology called [Multimedia Internet Mail Extensions \(MIME\)](#), which

define a mechanism for encoding and identifying non-text data—exactly what HTTP needed to do. Since TCP/IP developers wisely reuse technologies that work, the creators of HTTP borrowed many concepts from MIME, including many of the [MIME e-mail headers](#) that are used to identify the contents of a MIME message.

Media Types and Subtypes

The most important concept that HTTP adopted from MIME was the use of standardized Internet media types, which describe the contents of an HTTP entity. Each media type consists of a top-level media type that defines its general nature, and a more specific subtype that indicates its form or structure. Additional parameters may also be supplied in some cases to provide more information to help a recipient interpret the entity. The formal syntax of an HTTP media type is the same as that used in MIME:

`<type>/<subtype> [; parameter1 ; parameter2 ... ; parameterN]`

To understand the difference between a top-level media type and a subtype we need only take a couple of examples. Text documents use the general type “text”; within this, subtypes exist such as “plain” for regular unformatted text and “html” for HTML documents. So, an HTML document of the type commonly transported using HTTP will be identified with a media type of “text/html”. Similarly, “image” is a top-level media type, and has subtypes such as “jpeg”, “gif” and “tiff”. Photographs usually use “image/jpeg”, while line drawings are often seen as “image/gif”.

HTTP's Use of Media Types

In HTTP, media types are most often seen in a special *Content-Type* [entity header](#), which is present in any HTTP message that carries an entity. This header uses the same format as the header of the same name in MIME:

Content-Type: `<type>/<subtype> [; parameter1 ; parameter2 ... ; parameterN]`

The other place where media types are used in HTTP is in the *Accept* [request header](#), which may appear in an HTTP request sent by a client. If present, the purpose of this header is to tell the server what sorts of media types the client can handle, so the server will not send a response that cannot be processed. For example, if a client can only process text documents, it might send a request specifying this in an *Accept* header. This is part of the overall [content negotiation process](#) supported by HTTP.

When a media type is specified in an *Accept* header, either the subtype, or both the type and subtype, can be replaced by the “*” wildcard to represent “any acceptable”. For example, in an *Accept* header, the specification “text/html” refers to an HTML document, while “text/*” means “any text type”. The string “*/*” means any type of media; this is usually used in combination with a “q” value as explained in the topic on the HTTP [content negotiation process](#).



Related Information: I provide a more complete description of both the *Content-Type* header and Internet media types, including a description of many types and subtypes, in [the topic on media types in the MIME section](#). HTTP can also support [composite media types](#), such as the multipart media type.



Key Concept: While HTTP is naturally most often associated with hypertext, its messages can transport a large variety of different types of files, including images, audio, video and much more. To indicate the type of entity contained in an HTTP message, its sender must identify its media *type* and *subtype*. This is done using the HTTP *Content-Type* header, which was borrowed from the Multipurpose Internet Mail Extensions (MIME) specification.

Other MIME Constructs Used In HTTP

In addition to media types, HTTP also borrows from MIME in several other ways. These include the notion of [content codings](#) and [the use of a header to indicate the length of an entity](#). It's important to recognize, however, that even though HTTP's handling of Internet media is very similar to that of MIME, it is not identical. In fact, my understanding is that there was an early proposal that HTTP use MIME exactly as defined, but a specific decision was made not to do this. We will explore a possible reason why in [the next topic](#).

The bottom line, however, is that HTTP's developers chose to adopt concepts from MIME that made sense, and left other parts out. As a result, HTTP messages are not MIME compliant, even though you may see several headers in HTTP messages starting with MIME's "Content-" prefix. For example, even though HTTP has a *Content-Encoding* header, its use is quite different from that of MIME's, as we will again see in the next topic. Confirmation of the difference between HTTP and MIME can be found in the fact that HTTP does not use the *MIME-Version* header that is required in MIME messages.



Key Concept: Even though HTTP borrows several concepts and header types from MIME, the protocol is not MIME-compliant.

HTTP Data Transfer, Content Encodings and Transfer Encodings

In [the previous topic](#), I mentioned two specific issues that HTTP had to address in order to carry a wide variety of media types in its messages: encoding the data and identifying its type and characteristics. HTTP borrows from [MIME](#) the notion of media types and the *Content-Type* header to handle type identification, as we have already seen. It similarly borrows concepts and headers from MIME to deal with the encoding issue. Here, however, we run into some of the important differences between HTTP and MIME.

Encoding was a significant issue for MIME, because it was created for the specific purpose of sending non-text data using the old [RFC 822 e-mail message standard](#). RFC 822 imposes several significant restrictions on the messages it carries, the most important of which is that data must be encoded using 7-bit ASCII. RFC 822 messages are also limited to lines of no more than 1000 characters that end in a “CRLF” sequence.

These limitations mean that arbitrary binary files, which have no concept of lines and consist of bytes which can each contain a value from 0 to 255, cannot be sent using RFC 822 in their native format. In order for MIME to transfer these files, they must be encoded using a [method such as base64](#), which converts three 8-bit characters to a set of four 6-bit characters that can be represented in ASCII. When this sort of transformation is done, the MIME *Content-Transfer-Encoding* header is included in the message so the recipient can reverse the encoding to return the data to its normal form.

Now, while this technique works, it is less efficient than sending the data directly in binary, because base64 encoding increases the size of the message by 33% (three bytes are encoded using four ASCII characters, each of which takes one byte to transmit). HTTP messages are transmitted directly between client and server over a TCP connection, and do not use the RFC 822 standard. Thus, binary data can be sent between HTTP clients and servers without the need for base64 encoding or other transformation techniques. Since it is more efficient to send the data unencoded, this may be one reason why HTTP’s developers decided to not make the protocol strictly MIME compliant.

HTTP’s Two-Level Encoding Scheme

This would seem to be an area where HTTP was simpler than MIME—since there is no need to encode the entity, there is no need for the *Content-Transfer-Encoding* header, and we have one less thing to worry about. Ha, nice try! ☺ It is true that HTTP **could** have simply been designed so that all entities were just sent one byte at a time with no need to specify encodings. But the developers of the protocol recognized that this would have made the protocol inflexible. There are situations where it might be useful to transform or encode an entity or message for transmission, and then reverse the operation upon receipt.

This effort to make HTTP flexible resulted in a system of representing encodings that is actually more complicated than MIME’s. The key to understanding it is to recognize that HTTP/1.1 actually splits MIME’s notion of a “content transfer encoding” into two different encoding levels:

- ☉ **Content Encoding:** This is an encoding that is applied specifically to the entity carried in an HTTP message, to prepare or package it prior to transmission. Content encodings are said to be “end-to-end”, because the encoding of the entity is done once before it sent by the client or server, and only decoded upon receipt by the ultimate recipient: server or client. When this type of encoding is done, the method is identified in the special *Content-Encoding entity header*. A client may also specify what content encodings it can handle, using the *Accept-Encoding* header, as we will see in [the topic on content negotiation](#).

-
- ☉ **Transfer Encoding:** This is an encoding that is done specifically for the purpose of ensuring that data can be safely transferred between devices. It is applied across an entire HTTP message, and not specifically to the entity. This type of encoding is “hop-by-hop” because a different transfer encoding may be used for each hop of a message that is transmitted through many intermediaries in the [request/response chain](#). The transfer encoding method, if any, is indicated in the *Transfer-Encoding* [general header](#).

Use of Content and Transfer Encodings in HTTP

Since the two encodings are applied at different levels, it is possible for both to be used at the same time. A content encoding may be applied to an entity and then placed into a message. On some or all of the hops that are used to move the message containing that entity, a transfer encoding may be applied to the entire message (of course including the entity). The transfer encoding is removed first, and then the content encoding.

Okay, so what are these used for in practice? Not a great deal. The HTTP standard defines a small number of content and transfer encodings, and specifies that additional methods may be registered with the [IANA](#). As of the time that I write this, however, only the ones defined in the HTTP/1.1 standard are in use.

Content encodings are currently used only to implement compression. This is a good example of an encoding that while not strictly necessary, can be useful since it improves performance—for some types of data, dramatically. The RFC 2616 defines three different encoding algorithms: *gzip* (the compression used by the UNIX *gzip* program, and described in RFC 1952); *compress* (again, representing the compression method used by the UNIX program of that name) and *deflate* (a method defined in RFCs 1950 and 1951).



Note: It is also possible to apply compression to an entire HTTP message as a transfer encoding. Obviously, if the entity is already compressed using content encoding, this will result in some duplication of effort. Since the size of HTTP headers is not that large compared to some entities that HTTP messages carry, it is usually simpler just to compress the entity using content encoding.

Since transfer encodings are intended to be used to make data safe for transfer, and we’ve already discussed the fact that HTTP can handle arbitrary binary data, this suggests that transfer encodings are not really necessary. As it turns out, however, there is one situation where “safe transport” does become an issue: the matter of identifying the end of a message. This issue is the subject of [the next topic](#).



Key Concept: HTTP supports two levels of codings for data transfer. The first is *content encoding*, which is utilized in certain circumstances to transform the entity carried in an HTTP message; the second is *transfer encoding*, which is used to encode an entire HTTP message to assure its safe transport. Content encodings are often employed when entities are compressed to improve communication efficiency; transfer encoding is used primarily to deal with the problem of identifying the end of a message.

HTTP Data Length Issues, "Chunked" Transfers and Message Trailers

Two different levels of encodings are used in HTTP: *content encodings*, which are applied to HTTP entities, and *transfer encodings*, which are used over entire HTTP messages. Content encodings are used for convenience to package entities for transmission, where transfer encodings are hop-specific, and are intended for use in situations where data needs to be made “safe” for transfer.

However, [we've already seen in the previous topic](#) that HTTP can transport arbitrary binary data, so unlike the situation where MIME had to make binary data “safe” for RFC 822, this is not an issue. Therefore, why are transport encodings needed at all? In theory they are not, and HTTP/1.0 did not even have a *Transfer-Encoding* header (though it did use content encodings). The concept of transfer encoding became important in HTTP/1.1 due to another key feature of that version of HTTP: [persistent connections](#).

Recall that HTTP uses the [Transmission Control Protocol \(TCP\)](#) for connections. One of the key characteristics of TCP is that it [transmits all data as a stream of unstructured bytes](#). TCP itself does not provide any way of differentiating between the end of one piece of data and the start of the next; this is left up to each application.

In HTTP/1.0 (and HTTP/0.9) this was not a problem, because those versions used only transitory connections. Each HTTP session consisted of only one request and one response; since client and server only each sent one piece of data, there was no need to worry about differentiating HTTP messages on a connection. HTTP/1.1's persistent connections improve performance by letting devices send requests and responses one after the other over a single TCP connection. However, the fact that messages are sent in sequence makes differentiating them a concern.

Using The Content-Length Header

There are two usual approaches to dealing with this sort of data length issue: either using an explicit delimiter to mark the end of the message, or including a length header or field to tell the recipient how long each message is. The first approach could not really have been done easily while maintaining compatibility with older versions of the protocol. This left the second approach; since HTTP already had a *Content-Length* [entity header](#), the solution was to use this to indicate the length of each message at transmission time.

This method works fine in cases where the size of the entity to be transferred is known in advance, such as when a static file such as a text document, image or executable program needs to be transmitted. However, there are many types of resources that are generated dynamically; the total size of such a resource is not known until it has been completely processed. While not typical in HTTP's early days, these account for a large percentage of World Wide Web traffic today.

Many Web pages are often not static HTML files, but rather are created as output from scripts or programs based on user input; discussion forums would be a good example. Even HTML files today are often not static. They usually contain program elements such as *server-side includes (SSIs)* that cause code to be generated on-the-fly, so their exact size is cannot be determined in advance.

Using "Chunked" Transfers

The problem of unknown message length could be resolved by buffering the entire resource before transmission. However, this would be wasteful of server memory and would delay the transmission of the entity unnecessarily—no part could be sent until the entire entity was ready. Instead, a special transfer encoding method was developed to handle this particular problem of “unsafe” transport: not knowing the length of a file. The method is called *chunking*.

When this technique is used, instead of sending an entity as a raw sequence of bytes, it is broken into, well, chunks. ☺ This allows HTTP to send a dynamically-generated resource, such as output from a script, a piece at a time as the data becomes available from the software processing it. To indicate that this method has been used, the special header “*Transfer-Encoding: chunked*” is placed in the message. A special format is also used for the body of the HTTP message to delineate the chunks:

```
<chunk-1-length>
<chunk-1-data>
<chunk-2-length>
<chunk-2-data>
...
0
<message-trailers>
```

Basically, instead of putting the whole entity in the body and indicating its length in a *Content-Length* header, each chunk is placed in the body sequentially, each preceded by the length of the chunk. The length is specified in hexadecimal, and represented using ASCII characters. All chunk lengths and chunk data are terminated with a “CRLF” sequence. The recipient knows it has received the last chunk when it sees a chunk-length of zero.



Key Concept: Since HTTP/1.1 uses persistent connections that allow multiple requests and responses to be sent over a TCP connection, clients and servers need some way to identify where one message ends and the next begins. The easier solution is to use the *Content-Length* header to indicate the size of a message, but this only works when the length of a message can be easily determined in advance. For dynamic content or other cases where message length cannot be easily computed before sending the data, the special *chunked* transfer encoding can be used, where the message body is sent as a sequence of chunks, each preceded by the length of the chunk.

Message Trailers

When chunked transfer encoding is used, the sender of the message may also choose to specify one or more *message trailers*. These are the same as [entity headers](#), describing the contents of the message body, but appear after the entity instead of before it. They provide flexibility in the same way that chunking itself does—they allow a device to include an HTTP header that may contain information that was not available when the HTTP message transmission began. A good example would be an integrity check field calculated based on the byte values of the entire entity.

Trailers are optional, and not always be needed. When they are used, they are processed just like regular entity headers. To give the recipient of a message a “heads up” that trailers have been used, the special *Trailer* header should be included at the start of the message, which lists the names of each header that appears as a trailer.

Example Using the Content-Length Header and "Chunking"

Yes, I really did say that headers can actually be trailers, in which case a header called *Trailer* lists each header that is actually a trailer. Perhaps an example would help clarify matters somewhat? Suppose we have a server that contains a program that, when supplied with a file name, returns a simple HTML response that contains the size and last modification date of the file. This is obviously dynamic content, so the length of the response cannot be determined in advance.

If the server were to buffer the entire output of this program (since it is small) it could construct a conventional HTTP response using the *Content-Length* header, as shown in the sample output of [Table 279](#). Instead, chunking allows the server to send out parts of the response as soon as they become available from the program. The equivalent output of that example using chunked transfers is shown in [Table 280](#); notice that the *Expires* header is now a trailer, so it can be calculated based on the output of the program, and this is

indicated by the “*Trailer: Expires*” header. Remember that the *Content-Length* header specifies the length as a decimal number while chunking specifies chunk lengths in hexadecimal; the chunks in this example are 41, 5, 35, 29 and 19 bytes, respectively.

Table 279: Example HTTP Response Using Content-Length Header

```
HTTP/1.1 200 OK
Date: Mon, 22 Mar 2004 11:15:03 GMT
Content-Type: text/html
Content-Length: 129
Expires: Sat, 27 Mar 2004 21:12:00 GMT

<html><body><p>The file you requested is 3,400 bytes long and was
last modified: Sat, 20 Mar 2004 21:12:00 GMT.</p></body></html>
```

Table 280: Example HTTP Response Using Chunked Transfer Encoding

```
HTTP/1.1 200 OK
Date: Mon, 22 Mar 2004 11:15:03 GMT
Content-Type: text/html
Transfer-Encoding: chunked
Trailer: Expires

29
<html><body><p>The file you requested is
5
3,400
23
 bytes long and was last modified:
1d
Sat, 20 Mar 2004 21:12:00 GMT
13
.</p></body></html>
0
Expires: Sat, 27 Mar 2004 21:12:00 GMT
```



Note: An HTTP/1.1 client can specify that it does not want to use persistent connections by including the “*Connection: close*” header in its request. In this case, the server does not have to use chunking in its response—since it will close the connection after the first response message, the client knows that everything it receives from the server is part of that response. However, some servers may use chunked transfers anyway, even in this situation.



Key Concept: When chunked transfer encoding is used, the sender of the message may move certain headers from the start of the message to the end, where they are known as *trailers*. They are interpreted in the same way as normal headers by the recipient. The special *Trailer* header is used in such messages to tell the recipient to look for trailers after the body of the message.

HTTP Content Negotiation and "Quality Values"

Many Internet resources have only one representation, meaning a single way in which they are stored or made available. In this situation, a client request to a server is an “all or nothing” proposition. The client may specify conditions under which it would like the server to send the resource, using the “*If-*” series of [request headers](#). If the condition is met, the resource will be sent in the server’s response in the one form in which it exists; if the condition is not met, no entity will be returned.

Other resources, however, may have multiple representations. The most common example would be a document that is available in multiple languages, or that is stored using more than one character set. Similarly, a graphical image might exist in two different formats: one a Tagged Image File Format (TIFF) file for those wanting maximum image quality despite the large size of TIFF images; and a more compact JPEG file for those who need to see the image quickly and don’t care as much about its quality level.

Content Negotiation Techniques

To provide flexibility in allowing clients to obtain the best version of resources that exist in multiple forms, HTTP/1.1 defines a set of features that are collectively called *content negotiation*. The standard defines two basic methods by which this negotiation may be performed:

- ☉ **Server-Driven Negotiation:** In this technique, the client includes headers in its request that provide guidance to the server about its desired representation for the resource. The server uses an algorithm that processes this information and provides the version of the resource that it feels best matches the client’s preferences.
- ☉ **Agent-Driven Negotiation:** This method puts the client in charge of the negotiation process. It first sends a preliminary request for the resource to the server. If the resource is available in multiple forms, the server typically sends back a 300 (“*Multiple Choices*”) response, which contains a list of the various representations in which the resource is available. The client then sends a second request for the one that it prefers.

Comparing Negotiation Methods

To draw an analogy, suppose a co-worker offers to go out at lunch-time to pick up lunch for the two of you, at a new restaurant where neither of you have eaten before. You could provide him with some parameters regarding what you like to eat—“I like roast beef sandwiches, fish & chips, and pizza, but not chicken”—and then trust him to pick something

you will like. Or, he could go to the restaurant, call you on his cell phone, and read the menu to you and let you make a selection. This first is like server-driven negotiation; the second, like agent-driven negotiation.

I think this is a good analogy not only because it (hopefully) helps you see the differences between the two methods, but it also highlights the key advantages and disadvantages of each. Trusting your co-worker with your lunch selection is simple and efficient, but not foolproof. It's possible that the restaurant may not have any of the items you specified, or that your friend may get you something containing another ingredient that you don't like but that you forgot to mention. Similarly, server-based negotiation is a "best-guess" process that does not guarantee that the client will receive the resource in the format it wants. This is exacerbated by the fact that there are only so many ways for the client to specify its preferences using a handful of request headers.

Agent-based negotiation, on the other hand, allows the client to select exactly what it wants from the available choices, just as you can choose your favorite dish from the menu of the restaurant. The problem here is that it is inefficient, because two requests and responses are required for each resource access. (Would **you** really want to read a restaurant's menu over the phone to someone so they could choose their ideal dish? 😊)



Key Concept: HTTP includes a feature called *content negotiation* that allows the selection of a particular variation of a resource that has more than one representation. There are two negotiation techniques: *server-driven*, where the client includes headers in its request that indicate what it wants and the server does its best to select the most appropriate variant; and *agent-driven*, where the server sends the client a list of the available resource alternatives and the client chooses one.

Server-Based Negotiation in HTTP

In practice, server-based negotiation is the type that is most commonly used today. The client specifies its preferences using a set of four **request headers** that indicate what it would prefer in the representation of the resource. The headers each represent one characteristic of a resource: *Accept* (media type); *Accept-Charset* (character set); *Accept-Encoding* (content encoding); and *Accept-Language* (resource language). Any or all of these may be included in the request.

Each "*Accept-*" header contains a list of acceptable values that is appropriate to the characteristic that it specifies, separated by a comma. For example, the *Accept* header lists **media types** the client considers acceptable, while *Accept-Language* contains language tags. Suppose you have a friend who is trilingual in English, French and Spanish. She can read a particular document in any of these languages, so she might instruct her browser to include the following header in her requests:

Accept-Language: en, fr, sp

Weighting Preferences with "Quality Values"

Even better than simple acceptance lists, HTTP allows the client to *weight* each of the items in such a list, to indicate which is preferred of the alternatives. This is done by adding a decimal quality value after each parameter using the syntax "q=<value>", which represents the relative priority of that parameter relative to others. The highest priority is 1 and the lowest is 0; the default if no value is indicated is 1, while a value of 0 means the client is specifically saying it is *not* willing to accept documents with that characteristic.

This is best illustrated by an example, so let's take our trilingual friend again. This time, let's say she knows English, French and Spanish, but her French is a bit rusty (she hasn't used it in a while). Furthermore, she may need to share this document with a friend of hers who only knows a little Spanish, so it would be best if she got the document in English. Finally, she knows there is a German version of the resource that she definitely does not want. This could be represented as follows:

```
Accept-Language: en, fr;q=0.3, sp;q=0.7, de;q=0
```

Translated to English, this means "I prefer if you sent me the document in English. If not, Spanish is okay, or French if that is all you have, but definitely don't send it in German".

Incidentally, the name "quality value" is the one used in the HTTP standard, but is really a poor choice of terminology (which, to be fair, is also mentioned in the standard!) These values do not really have anything to do with quality; for all we know, the German version of this document may be the original and the others could be lousy translations. The "q" values only specify the relative preference of the client making the request.

Finally, the "*" wildcard can be used in the Accept family of headers to represent "any value", or "everything else". This is often used to tell the server "if you can't find what I specifically asked for, then here's my preference level on the alternatives". Let's take an example using the *Accept* header:

```
Accept: text/html, text/*;q=0.6, */*;q=0.1
```

This header represents the client saying "My preference (q=1) is an HTML text document. If not available, I would prefer some other type of text document. Failing that, you may send me any other type of document relevant to the requested resource."



Key Concept: Server-driven content negotiation is the type most often used in HTTP. A client sending a request can include up to four different headers that provide information about how the server should fill its request. These may include optional *quality values* that specify the client's relative preference amongst a set of alternative resource characteristics such as media type, language, character set or encoding.



HTTP Features, Capabilities and Issues

The first four subsections of the large section covering the Hypertext Transfer Protocol were meant to give you a good understanding of the fundamental concepts and basic operation of the protocol. Modern HTTP, however, goes beyond the simple mechanics by which HTTP requests and responses are exchanged. It includes a number of features and capabilities that extend the basic protocol to improve performance and meet the various needs of organizations using modern TCP/IP internetworks.

In this section, I complete my description of HTTP by discussing several important matters that are essential to the operation of the modern World Wide Web. I begin with an overview of HTTP caching, which is the single most important feature that promotes efficiency in Web transactions. I discuss the different uses of proxies in HTTP and some of the issues associated with them. I briefly examine the issues related to security and privacy in HTTP, and conclude with a discussion of the matter of state management, and how it is implemented despite HTTP being an inherently stateless protocol.



Background Information: This section assumes that you have already covered the preceding ones in this larger section on HTTP. If you are not already familiar with concepts such as the [HTTP request/reply chain](#), [HTTP message structure](#) and [HTTP headers](#), you should review those materials first.

HTTP Caching Features and Issues

The explosive growth of the World Wide Web was a marvel for its users, but a nightmare for networking engineers. The biggest problem that the burgeoning Web created was an overloading of the internetworks over which it ran. Many of the features that were added to HTTP/1.1 were designed specifically to improve the efficiency of the protocol and reduce unnecessary bandwidth consumed by HTTP requests and responses. Arguably the most important of these is a set of features designed to support *caching*.

The subject of caching comes up again and again in discussions of computers and networking, because of a phenomenon that is widely observed in these technologies: whenever a user, hardware device or software process requests a particular piece of data, there is a good chance it will ask for it again in the near future. Thus, by storing recently-retrieved items in a cache, we can eliminate duplicated effort. This is why caching plays an important role in the efficiency of protocols such as [ARP](#) and [DNS](#).

The Significance of Caching to HTTP

Caching is important to HTTP because Web users tend to request the same documents over and over again. For example, in writing this section on HTTP, I made reference to RFC 2616 many, many times. Each time, I loaded it from a particular Web server. Since the document never changes, it would be more efficient to just load it from a local cache rather than having to retrieve it from the distant Web server each time.

However, caching is even more essential to HTTP than to most other protocols or technologies where it is used. The reason is that Web documents tend to be structured so that a request for one resource leads to a request for many others. Even if I load a number of **different** documents, they may each refer to common elements that do not change between user requests. Thus, caching can be of benefit in HTTP even if a user never asks for the same document twice, or if a single document changes over time so that caching the document itself would be of little value.

For example, suppose that each morning I load up CNN's Web site to see what is going on in the world. Obviously, the headlines will be different every day, so caching of the main CNN.com Web home page won't be of much value. However, many of the graphical elements on the page (CNN's logo, dividing bars, perhaps a "breaking news" graphic) will be the same, every day, and these can be cached. Another example would be a set of discussion forums on a Web site. As I load up different topics to read, each one is different, but they have common elements (such as icons and other images) that would be wasteful to have to retrieve over and over again.

Caching in HTTP yields two main benefits. The first is reduced bandwidth use, by eliminating unneeded transfers of requests and responses. The second, equally important, is faster response time for the user loading a resource. Consider that on many Web pages today, the image files are much larger than the HTML page that references them. Caching these graphics will allow the entire page to load far more quickly. [Figure 319](#) illustrates how caching reduces bandwidth and speeds up resource retrieval by "short-circuiting" the request/response chain.

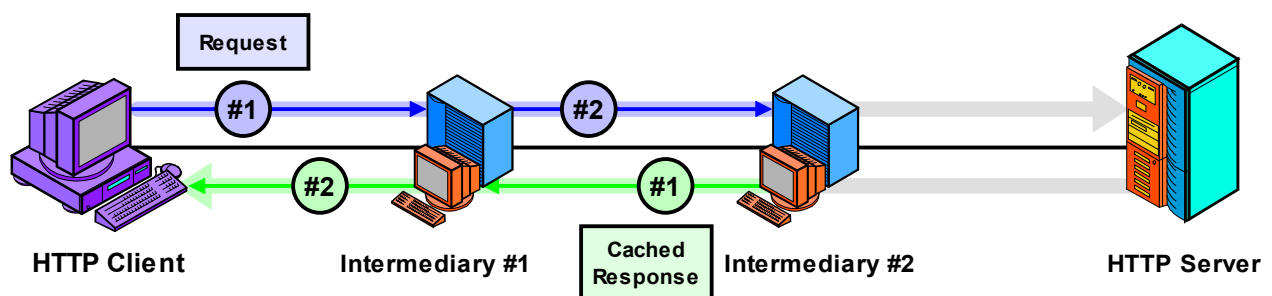

Figure 319: Impact of Caching on HTTP Request/Response Chain

This diagram illustrates the impact of caching on the request/response chain of [Figure 316](#). In this example, intermediary #2 is able to satisfy the client's request from its cache. This "short-circuits" the communication chain after two transfers, which means the client gets its resource more quickly, and the HTTP server is spared the need to process the client's request.

The obvious advantages of caching have made it a part of the Web since pretty much the beginning. However, it was not until HTTP/1.1 that the importance of caching was really recognized in the protocol itself, and many features added to support it. Where the HTTP/1.0 standard makes passing mention of caching and some of the issues related to it, HTTP/1.1 devotes 26 full pages to caching (over 20% of the main body of the document!) I obviously cannot go into that level of detail here, but I will discuss HTTP caching in general terms to give you a feel for the subject.

Tradeoffs in Cache Location

HTTP caching can be implemented in a variety of places in the request/response chain. The location of the cache must be chosen based on a fundamental trade-off that always occurs in caching: proximity versus universality. Simply put, the closer the cache is to the requestor of the information, the more savings that result when data is pulled from the cache rather than being fetched from the source. However, the further the cache is from the requestor (and thus closer to the source), the greater the number of devices that can benefit from the cache. Let's see how this manifests itself in the three classes of devices where caches may be found.

Web Client Caching

The cache with which most Internet users are familiar is that found on the local client. It is usually built into the Web browser software, and for this reason called a *Web browser cache*. This cache stores recent documents and files accessed by a particular user, so that they can be made quickly available if that user requests them again.

Since the cache is in the user's own machine, a request for an item that the cache contains is filled instantly, resulting in no network transaction and "instant gratification" for the user. However, that user is the only one who can benefit from the cache, which is for this reason sometimes called a *private cache*.

Intermediary (Proxy) Caching

Devices such as [proxy servers](#) that reside between Web clients and servers are also often equipped with a cache. If a user wants a document not in his or her local client cache, the intermediary may be able to provide it, as shown in [Figure 319](#). This is not as efficient as retrieving from the local cache, but far better than going back to the Web server. However, the intermediary has the advantage that all devices using it can benefit from its cache, which may be termed *public* or *shared*. This can be useful, because members of an organization often access similar documents.

For example, in an organization developing a hardware product to be used on Apple computers, many different people might be accessing documents on Apple's Web site. With a shared cache, a request from user A would often result in items being cached that could be used by user B.

Web Server Caching

Web servers themselves may also implement a cache. While it may seem a bit strange to have a server maintain a cache of its own documents, this can be of benefit in some circumstances. A resource might require a significant amount of server resources to create; for example, consider a Web page that is generated using a complex database query. If this page is retrieved frequently by many clients, there can be a large benefit to creating it periodically and caching it rather than generating it on the fly for each request.

Since the Web server is “farthest” from the users, this results in the least savings for a cache hit, as the client request and server response must still travel the full path over the network between client and server. However, this distance from the client also means that all users of the server can benefit from it.



Key Concept: The most important feature that improves the efficiency of operation of HTTP is *caching*—the storing of recently-requested resources in a temporary area. If the same resource is then needed again a short time later, it can be retrieved from the cache rather than requiring a fresh request to the server, resulting in a savings of both time and bandwidth. Caching can be performed by Web clients, servers and intermediaries. The closer the cache is to the user, the greater the efficiency benefits; the farther from the user, the greater the number of users that can benefit from the cache.

Cache Control

The control of caching in clients and servers is accomplished in the same manner that most other types of control are implemented in HTTP: through the use of special headers. The most important of these is the Cache-Control [general header](#), which has a number of directives that allow the operation of caches to be managed. There are other important caching-related headers, including *Expires* and *Vary*. For a great deal of more specific information related to HTTP caching, please consult RFC 2616, section 13.

Important Caching Issues

While the performance advantages of caching make it a “no-brainer”, there is no denying that caching has one significant drawback: it complicates the operation of HTTP in a number of ways. Below is a description of some of the more important issues that HTTP/1.1 clients, servers and intermediaries need to deal with. As long as it is, this list is not exhaustive, which gives you an idea of what is involved with caching in HTTP (as well as why the standard needed 26 pages to cover the subject!)

Cache Aging and “Staleness”

When a user retrieves a document directly from its original source on the server, he or she always is assured of getting the current version of that resource. When caching is used, that is no longer the case. While many resources change infrequently, almost all will change at some point in time. To take the example above of CNN’s Web site, it is probable that the CNN logo won’t change very often, but it’s possible that the site may be redesigned periodically and the logo modified in some way, such as its size or color.

For this reason, a device cannot keep items in an HTTP cache indefinitely. The longer an item is held in a cache—a process called *aging*—the more likely it is that the resource on the server has changed and the cache has become “stale”. To make matters even more complex, some resources become stale more quickly than others. As a result, much of the caching-related functionality of HTTP is related to dealing with this matter of cache aging.

Cache Expiration and Validation

One of the ways that HTTP deals with the cache aging issue is through headers and logic that allow caches, clients and servers to specify how long items should be cached before they expire and must be refreshed. A process of validation is also defined that allows a cache to check with a server at appropriate times to see if an item it has stored has been modified.

Communication of Cache Status to the User

In most cases, the fact that an item has been retrieved from a cache rather than its source is transparent to the user (though he or she may notice that the resource loads faster than expected!) In certain cases, however, the user may need to be informed that a resource came from a cache and not its original source. This is especially true when a cached item may be stale, in which case the client should warn the user that the information might be out of date.

Header Caching

Caching in HTTP is complicated by the fact that it can occur in multiple places, and some HTTP headers are treated differently than others. HTTP headers are divided into two general categories: *end-to-end headers* that are intended to accompany a resource all the way to its ultimate recipient, and *hop-by-hop headers* that are used only for a particular communication between two devices (be they client, server, or intermediary device). End-to-end headers must be stored with a cached resource, where hop-by-hop headers only have meaning for a particular transfer and are not cached.

Impact of Resource Updates

Some [HTTP methods](#) will automatically cause cache entries to become invalidated, because they inherently cause a change to the underlying resource. For example, if a user performs a *PUT* on a resource that was previously retrieved using *GET*, any cached copies of that resource should be automatically invalidated to prevent the old version from being supplied from the cache.

Privacy Concerns

In the case of shared caches (such as might exist in a proxy) there are potential privacy issues to be concerned with. While in most cases having user *A*'s cached resource be made available to user *B* is advantageous, we must be careful not to cache any items that might be specific to user *A*, which user *B* should not see.

HTTP Proxy Servers and Proxying

In my overview of [the HTTP operational model](#), I described how HTTP was designed to support not just communication between a client and server, but also the inclusion of intermediaries that may sit in the communication path between them. One of the most important types of intermediary is a device called a *proxy server*, or more simply, just a *proxy*.

A proxy is a “middleman” that acts as both a client and a server. It accepts requests from a client as if it were a server, then forwards them (possibly modifying them) to the real server, which sees the proxy as a client. The server responds back to the proxy, which forwards the reply back to the client. Proxies can be either *transparent*, meaning that they do not modify requests and responses, or *non-transparent*, if they do so in order to provide a particular service.



Note: The term “transparent proxy” can also be used to refer to a proxy that is interposed automatically between a client and server—such as an organization-wide firewall—as opposed to one that a user manually configures.

Benefits of Proxies

Since proxies have the ability to fully process all client requests and server responses, they can be extremely useful in a number of circumstances. They can be used to implement or enhance many important capabilities.

Security

Proxies can be set up to examine both outgoing requests and incoming responses, to address various security concerns. For example, filtering can be set up to prevent users from requesting “objectionable” content, or to screen out harmful replies such as files containing hidden viruses.

Caching

As I mentioned in [the previous topic](#), it can be advantageous to set up a “shared cache” that is implemented on an intermediary, so resources requested by one client can be made available to another. This can be done within a proxy server.

Performance

In some circumstances, the existence of a proxy server can significantly improve performance, particularly by reducing latency. An excellent example of this is the proxy server that is used by my own satellite Internet connection.

Due to the distance from the earth to the satellite, it takes over 500 milliseconds for a round trip request/response cycle between my PC and an Internet server. If I load a Web page containing images, I would have to wait 500+ milliseconds to get the HTML page, at which point my browser would then have to generate new requests for each graphical element, meaning another 500+ millisecond delay for each.

Instead, my ISP has a proxy server to which I send my requests for Web pages. It looks through the HTML of these pages and automatically requests any elements such as graphics for me. It then sends them straight back to my machine, cutting the time required to display a full Web page drastically.



Key Concept: One of the most important types of intermediary devices in HTTP is a *proxy server*, which acts as a middleman between the client and server, handling both requests and responses. A proxy server may either transport messages unchanged or may modify them to implement certain features and capabilities. Proxies are often used to increase the security and/or performance of Web access.

Comparing Proxies and Caches

Proxying and caching are concepts that have a number of similarities, especially in terms of the impact that they have on basic HTTP operation. Like caching, proxying has become more important in recent years, and also complicates HTTP in a number of ways. The HTTP/1.1 standard includes a number of specific features to support proxies, and also addresses a number of concerns related to proxying.

The fact that both proxying and caching represent ways in which basic HTTP client/server communication is changed, combined with the ability of proxies to perform caching, sometimes leads people to think caches and proxies are the same, when they are not. A proxy is actually a separate element that resides in the HTTP request/response chain, where caches can be implemented within any device in that chain, including a proxy.

Another key way that caches and proxies differ is that caches are used “automatically” when they are enabled, where proxies are not. To use a proxy, client software must be told to use the proxy, and supplied with its IP address or domain name. The client then sends all requests to the proxy rather than to the actual server that the user specifies.



Note: Most of my explanations here have focused on hardware proxy servers, but proxies are also commonly implemented as software in a client device. A software proxy performs the same tasks of processing requests and responses; it is much cheaper to implement than a hardware proxy, but cannot be shared by many devices.

Important Proxying Issues

As I mentioned above, there are a few different issues that come into play when proxies are used in HTTP. Here are some of the more important ones, and how HTTP deals with them. Again, for much more information on proxying, please refer to your trusty copy of RFC 2616.

Capability Inconsistencies:

Issues arise when a client and server don't use the same version of HTTP, or don't support the same features; for example, some servers may not support all of the methods that a client may try to use. This is made all the more complex when a proxy enters the picture. Of

particular concern is the situation where a client and server may agree on a particular feature that the proxy does not. The proxy must make sure that it passes along headers or other elements that it may not comprehend.

Authentication Issues

The use of proxy servers often introduces new authentication or security requirements. In addition to authenticating with an end server, the proxy may specify that the client needs to present separate authentication credentials to it as well. This is done using the *HTTP Proxy-Authorization* and *Proxy-Authenticate* headers; [see the topic on HTTP security](#) for details.

Caching Interaction

Not only do both caching and proxying both complicate HTTP, they can complicate each other. Many of [the issues in handling caching](#), such as header caching, expiration and validation, become more complex when proxies are involved. Some of the *Cache-Control* [general header](#) directives are specific to proxying.

Another issue is that the use of proxying and caching together can lead to distortions in the apparent number of times that a Web resource is accessed. This is important in situations where Web pages are supported by advertising, based on the number of times the page is accessed. Sometimes in this situation, special codes are placed in URLs called “cache busters” are used to force pages not to be stored in shared caches.

Encodings

[Content encodings](#) are applied end-to-end and so should not be affected by proxies. Transfer encoding is done hop-by-hop, so a proxy may use different encodings in handling different transfers of a single request or response.

Tracing Proxy Handling

It is useful in some circumstances, especially when multiple proxies may be in the request/response chain, to be able to trace what proxies have processed a particular message. To this end, HTTP/1.1 requires that each proxy that handles a message identify itself in the *Via* header.

HTTP Security and Privacy

There are a number of different protocols in this Guide where I address security considerations. Usually, I start out by saying something to the effect that the protocol doesn't include much in the way of security, because when it was first developed, the Internet was small and used by a tight-knit group, so security wasn't a big concern. Today, the Internet is globe-spanning and used by millions of strangers, making security a big deal indeed, blah blah blah. ☺

Well, in the case of the World Wide Web this is true, but the issue is even more important due to the significance of the changes in the **content** of what HTTP messages carry. HTTP has become the vehicle for transporting any and every kind of information, including a large amount of personal data. HTTP was initially designed to carry academic documents such as memos about research projects, but today is more likely to carry someone's mortgage application, credit card details or medical details. Thus, not only does HTTP have the usual security issues such as preventing unauthorized access, it needs to deal with privacy concerns as well.

HTTP Authentication Methods

The main HTTP/1.1 standard, RFC 2616, also does not deal extensively with security matters. These are addressed in detail instead in the companion document, RFC 2617, which explains the two methods of HTTP authentication. Highly summarized, they are:

- ① **Basic Authentication:** This is a conventional user/password type of authentication. When a client sends a request to a server that requires authentication to access a resource, the server sends a response to the client's initial request that contains a *WWW-Authenticate* header. The client then sends a new request containing the *Authorization* header, which carries a [base64-encoded](#) username and password combination.
- ② **Digest Authentication:** Basic authentication is not considered strong security because it sends credentials "in the clear", which means that they can be intercepted. Digest authentication uses the same headers as basic authentication, but employs more sophisticated techniques, including encryption, that protect against a malicious person "snooping" credentials information. Digest authentication is not considered as strong as public key encryption, but is a lot better than basic authentication. It's also a darn sight more complicated. The full details of how it works are in RFC 2617.

Security and Privacy Concerns and Issues

Both RFC 2616 and 2617 also address some of the specific security concerns and threats that can potentially affect HTTP clients and servers. These include actions such as spoofing, counterfeit servers, replay attacks and much more. One concern addressed is the potential for "man-in-the-middle" attacks, where an attacker interposes between the client and server. Since proxies are inherently "men in the middle", they represent a security concern in this area. The same authentication methods used for servers can also be applied to authentication with proxies. The *Proxy-Authenticate* and *Proxy-Authorization* headers are used instead of *WWW-Authenticate* and *Authorization*.

The standards also discuss a number of privacy issues. Some that are worthy of note:

- ③ **Handling of Sensitive Information:** The HTTP protocol can carry any type of information, and it does not inherently protect the privacy of data in HTTP message entities. To ensure the privacy of sensitive information, other techniques must be used (which we will discuss shortly).

-
- **Privacy of Information in URLs:** One issue that sometimes arises in HTTP is that poorly-designed Web sites may inadvertently encode private information into URLs. These URLs may be recorded in Web logs, where they could fall into the hands of people who could abuse them. An example of this would be a Web site that submits a user login and password to a server by encoding them as parameters of a *GET* request such as this:

GET http://www.somesite.com/login?name=xxx&password=yyy”

The *POST* method should be used instead for this sort of functionality, because it transmits its data in the body of the message instead of putting it into the URL.

- **Private Information in Accept Headers:** While this may seem strange at first, it is possible that private information about the user could be transmitted through the use of certain “*Accept-*” headers used for [content negotiation](#). For example, some users might not want others to know what languages they speak, so they may be concerned about who looks at the *Accept-Language* header.
- **Information Obtained From the Referer Header:** The Referer [sic] [request header](#) is a double-edged sword; it can be very useful to those who operate Web sites because it lets them see the sources of links to their resources. At the same time, it can be abused by those who might employ it to study users’ Web access patterns. There are also potential privacy issues that the HTTP standard raises. For example, a user might not want the name of a private document that references a public Web page to be transmitted in a Referer header.

Methods for Ensuring Privacy in HTTP

As mentioned earlier, HTTP does not include any mechanism to protect the privacy of transmitted documents or messages. There are two different methods by which this is normally accomplished. The simplest way is to encrypt the resource on the server and supply valid decryption keys only to authorized users; even if the entire message is intercepted, the entity itself will still be secured. The level of protection here depends on the quality of the encryption.

Another more common method is to use an “add-on” protocol designed specifically to ensure the privacy of HTTP transactions. The one often used today is called *Secure Sockets Layer (SSL)*. Servers employ SSL to protect sensitive resources, such as those associated with financial transactions. They are accessed by using the [URL scheme](#) “https” rather than “http” in a Web browser that supports the protocol. SSL was originally developed by Netscape and is now widely used across the World Wide Web.

HTTP State Management Using “Cookies”

Even though the modern Hypertext Transfer Protocol has a lot of capabilities and features, it is still, at its heart, a simple request/reply protocol. One of the unfortunate problems that results from this is that HTTP is entirely *stateless*. This means that each time a server receives a request from a client, it processes the request, sends a response, and then forgets about the request. The next request from the client is treated as independent of any previous ones.



Note: The [persistent connection feature](#) of HTTP/1.1 does not change the stateless nature of the protocol. Even though multiple requests and responses can be sent on a single TCP connection, they are still not treated as being related in any way.

So why is this a problem? Isn't this what we would expect of a protocol designed to allow a client to quickly and efficiently retrieve resources from a server? Well, this is, yet again, another place where HTTP's behavior was well-suited to its original intended uses, but not to how the Web is used today. Sure, if all we want to do is to say "hey server, please give me that file over there", then the server doesn't have to care about whether or not it may have previously provided that client with any other files in the past. This is how HTTP was originally intended to be used.

Today, as most of us know, the Web is much more than a simple resource-retrieval protocol. If you go to an online store, you want to be able to select a number of items to put into a "shopping cart", and have the store's server remember them. You might also want to participate in a discussion forum, which requires you to provide a user name and password in order to post a message. Ideally, the server should let you log in once and then remember who you are so you can post many messages without having to enter your login information each and every time. (I have used forums where the latter is required—it gets old very quickly, believe me.)

Cookies: Storing HTTP State Information

For these and other interactive applications, the stateless nature of HTTP is a serious problem. The solution was the addition of a new technology, called *state management*, that allows the state of a client session with a server to be maintained across a series of HTTP transactions. Initially developed by Netscape, this technique was later made a formal Internet standard in RFC 2109, later revised in RFC 2965 ([HTTP State Management Mechanism](#)). Note that this feature is actually not part of HTTP; it is an optional element, but one that has been implemented in pretty much all Web browsers due to its usefulness.

The idea behind state management is very simple. When a server implements a function that requires state to be maintained across a set of transactions, it sends a small amount of data to the Web client called a "cookie". The cookie contains important information relevant to the particular Web application, such as a customer name, items in a shopping cart, or a user name and password. The client stores the information in the cookie, and then uses it in subsequent requests to the server that set the cookie. The server can then update the cookie based on the information in the new request and send it back to the client. In this manner, state information can be maintained indefinitely, allowing the client and server to have a "memory" that persists over a period of time.



Note: “Cookie” may seem an odd term, but is used in a few contexts to refer to a small piece of significant data—another example is found in the [BOOTP/DHCP message format](#). Today, most knowledgeable Web users would blink at you if you mentioned the “HTTP state management mechanism” but they usually know what “cookies” are.

Issues with Cookies

Cookies sound like a great idea, right? Well they are—and they aren’t. On the positive side, cookies are absolutely essential for many of the applications that make the Web the powerhouse it is today, the examples of online shopping and discussion forums being only two of many. Most of the time, cookies are used for these sorts of useful and benign purposes. Unfortunately, like every good idea, there are those who have found a way to turn cookies to the “dark side” by finding ways to abuse them. There can even be potential problems with them when there is no nefarious intent. For this reason, cookies are rather controversial.

Some of the issues with cookies:

- ☉ **Transmission of Sensitive Information:** Suppose you use an online banking system. You log in to the server, which then stores your login and password (which controls access to your account) in a cookie. If the application is not implemented carefully, the message containing that cookie could be intercepted, giving someone access to your account. Even if it is not, someone knowledgeable who gained access to your computer could retrieve the information from the file where cookies are stored.
- ☉ **Undesirable Use of Cookies:** In theory, cookies should be a help to the user, not a hindrance. However, any server can set a cookie for any reason. In some cases, a server could set a cookie for the purpose of tracking the sites that a user visits, which some people consider a violation of their privacy. Since some Web browsers do not inform the user when a cookie is being set, they may not even be aware that this is happening.
- ☉ **Third-Party or “Unintentional” Cookies:** While most people think of cookies as being set in the context of a resource they specifically request, a cookie may be set by **any** server to which a request is sent, whether the user realizes it or not. Suppose you send a request to “<http://www.myfavoritesite.com/index.htm>” and that page contains a reference to a tiny image that is on the server “<http://www.bigbrotherishere.com>”. The second site can set a cookie on your machine even though you never intended to visit it at all. This is called a “third-party cookie”.

Managing Cookie Use

The RFCs describing the cookie state management technique deal extensively with these and other issues, but there is no clear-cut resolution to these concerns. Like most security and privacy matters, the most important determinant of how significant potential cookie abuse may be is your own personal comfort level. Millions of people browse the Web every day letting any and all sites set whatever cookies they want, and never have a problem. Others consider cookies an offensive idea and disable all cookies, which eliminates the

privacy concerns but can cause problems with useful applications like interactive Web sites. As usual, the best approach is usually something in the middle, where you choose when and how you will allow cookies to be set.

The degree to which “cookie control” is possible depends greatly on the quality and feature-set of your Web client software. Many browsers do not provide a great deal of control in how and when cookies are set, where others are much better in this regard. Some allow cookies to be disabled, but come with them turned on by default, and since many people are not even aware of the issues I have mentioned above, they will not even realize when cookies are being sent. Most notable in this regard is the most popular browser in the world, Microsoft’s Internet Explorer, which normally comes set by default to accept all cookies without complaint or even comment.

Internet Explorer does allow you to disable cookies, but you have to do it yourself. It also allows you to differentiate between first-party and third-party cookies, but again, you must turn this on. Other browsers have more sophisticated settings, which will let you dictate conditions under which cookies may be set and others when they may not. Some will even let you allow certain sites to send cookies while prohibiting them from others. Better ones will also let you visually inspect cookies, and selectively clear the ones you do not want on your machine.

Third-party cookies can be used by online advertising companies and others to track the sites that a Web user visits. For this reason, they are considered by many people to fall into the general category of undesirable software called spyware. There are numerous tools that will allow you to identify and remove tracking cookies from your computer; many are available free on the Web.



Key Concept: HTTP is an inherently *stateless* protocol, because a server treats each request from a client independently, forgetting about all prior requests. This characteristic of HTTP is not an issue for most routine uses of the World Wide Web, but is a problem for interactive applications such as online shopping where the server needs to keep track of a user’s information over time. To support these applications, most HTTP implementations include an optional feature called *state management*. When enabled, a server sends to a client a small amount of information called a *cookie*, which is stored on the client machine. The data in the cookie is returned to the server with each subsequent request, allowing the server to update it and send it back to the client again. Cookies thus enable a servers to remember user data between requests. However, they are controversial, because of certain potential privacy and security concerns related to their use.



Gopher Protocol (Gopher)

Let's suppose that I told you I was going to describe a TCP/IP application layer protocol designed for the specific purpose of distributed document search and retrieval. This protocol uses a [client/server model of operation](#), where servers provide links to related resources such as files or programs that users access with client software that displays options for the user to select. You might think that I was talking about the [World Wide Web](#), and for good reason. However, in this case I am actually talking about one of the Web's predecessors: the *Gopher Protocol*.

A good place to start our discussion of this protocol is with its name, which is well-chosen for a number of reasons. The Gopher Protocol was developed at the University of Minnesota, whose sports teams are called the "Golden Gophers" (Minnesota is known as the "Gopher State"). This is the direct origin of the name, but it is also appropriate because the rodent that shares it is known for burrowing, just as the protocol is designed to "burrow" through the Internet. And of course, the term "gopher" also applies to a person who performs errands, such as retrieving documents (they "go fer" this, and "go fer" that). ☺

The Gopher Protocol was developed in the late 1980s to provide a mechanism for organizing documents for easy access by students and faculty at the university. The core principle that guided the development of the system was *simplicity*. Gopher is designed on the basis of a small number of core principles, and uses a very straight-forward mechanism for passing information between client and server devices. It is described in RFC 1436, published in March 1993.

Information Storage on Gopher Servers

Information accessible by Gopher is stored as files on *Gopher servers*. It is organized in a hierarchical manner similar to the file system tree of a computer such as a Windows PC or UNIX workstation. Just as a file system consists of a top-level directory (or folder) that contains files and subdirectories (subfolders), Gopher servers present information as a top-level directory that contains resources such as files, and/or subdirectories containing additional resources. Resources on different servers can be linked together using by having them mentioned in each others' resource hierarchies. It is also possible for "virtual" resources to be created that act as if they were files, such as programs that allow Gopher servers to be searched.

Gopher Client/Server Operation

Typical use of Gopher begins with a user on a client machine creating a TCP connection to a Gopher server using [well-known TCP port](#) number 70. After the connection is established, the server waits for the client to request a particular resource by sending the server a piece of text called a *selector string*. Often, when a user first accesses a server, he or she does not know what resource to request, so a null (empty) selector string is sent. This causes the server to send back to the client a list of the resources available at the top (root) directory of the server's file system tree.

Directory Listing Structure

A directory list sent by the server consists of a set of lines, each of which describes one available resource in that directory. Each line contains the following elements, each of which is separated by a “<Tab>” character:

- ① **Type Character and Resource Name:** The first character of the line tells the client software what sort of resource the line represents. The most common type characters are “0” for a file, “1” for a subdirectory and “7” for a search service. The rest of the characters up to the first “<Tab>” contain the name of the resource to be presented to the user.
- ② **Selector String:** The string of text to be sent to the server to retrieve this resource.
- ③ **Server Name:** The name of the server where the resource is located.
- ④ **Server Port Number:** The port number to be used for accessing this resource’s server; normally 70.

Each line ends with a “<CR><LF>” character sequence consistent with the [Telnet Network Virtual Terminal \(NVT\)](#) specification. Upon sending the directory listing (or any other response) the connection between the client and server is closed.

Menus and User Resource Selection

After receiving this sort of directory list, the Gopher client software will display a menu to the user containing all the resource names the server provided. The user then selects his or her desired item from the menu, and the client retrieves it by making a connection to the appropriate server and port number and sending the selector string of that resource. If this itself represents a subdirectory, a new directory listing for that subdirectory will be sent by the server; if some other type of resource, it will be accessed according to the requirements of the resource type.

For example, suppose this line were sent from the server to the client:

```
0Gopher Introduction<Tab>intro<Tab>gopher.someserver.org<Tab>70
```

This would be presented to the user as the file called “Gopher Introduction” in a menu containing other options. If the user chose it, the client would initiate a connection to the gopher server “gopher.someserver.org” at port 70, and then send the selector string “intro” to that server to retrieve the document.

Important Differences Between Gopher and The Web

As I hinted at the start of this discussion, both Gopher and the World Wide Web are intended for the same basic purpose: providing access to repositories of information, with links between related documents and resources. However, they take a very different approach to how that information is accessed, especially in two key areas: user interface and resource linking.

Gopher's presentation to the user is entirely oriented around its hierarchical file system. As a result, Gopher is inherently menu-based, and the user interface usually based on a simple text presentation of those menus. In contrast, information on World Wide Web servers can be organized in any manner, and presented to the user in whatever form or fashion the owner of the server desires. The Web is much more "free form", and there is no need to use a directory structure unless that is advantageous in some way.

Linking in the World Wide Web is done directly between documents, most often using [Hypertext Markup Language \(HTML\)](#) tags. When someone writing document *A* mentions something relevant to document *B*, he or she puts a link to *B* right into document *A* itself. Gopher, on the other hand, is not designed to use links in this way. Instead, linking is intended to be done using the directory tree we described earlier.

Gopher's Role in the Modern Internet

There are some people who believe that Gopher is technically superior to the Web in a number of respects. They consider it cleaner to have linking be done by servers, rather than having links embedded in documents. An argument can also be made that the text orientation of Gopher is efficient, better able to ensure compatibility between platforms, and also more suited to special needs situations such as low-bandwidth links and access by those with visual impairment. Some Gopher enthusiasts thus consider it to be a "purer" hypertext system than the World Wide Web.

However, history shows us that despite Gopher predating the World Wide Web, the Web overtook it in popularity in only a few short years. Today, the Web is the 900 pound gorilla of the Internet, while most people have never even **heard** of Gopher. What happened?

I believe the main reason why Gopher lost out to the Web is that the Web is far more *flexible*. Gopher's use of text hyperlinks and server directory structures may be efficient, but it is limiting. In contrast, the Web allows information to be presented in a wide variety of ways. The open, unstructured nature of the Web made it an ideal vehicle for the creativity of information providers and application developers. In the mid-1990s, the Web was also perfectly poised to support the transition of computing from text to graphics, and Gopher really was not.

Simply put, you can do more with the Web than you can with Gopher, and more people care about functionality and breadth of options than straight efficiency. Once the Web started to gain momentum, it very quickly snowballed, as I discuss in [the topic on the Web's history](#). It took only a couple of years before Web use was well-entrenched, and Gopher was unable to compete.

For its part, the University of Minnesota likely hastened Gopher's demise with its controversial decision to charge licensing fees to companies that wanted to use Gopher for commercial purposes. I do not believe there was anything nefarious about this: the university was on a limited budget and wanted companies that could afford it, to pay a small fee to support development of Gopher software. However, computing history has shown time and time again that there is no faster way to kill a protocol or standard than to try to charge licensing or royalty fees for it, no matter what the reason.

By the late 1990s, Gopher was well on its way to obsolescence. As use of the protocol dwindled, many organizations could no longer justify the cost of continuing to run Gopher servers. Even the University of Minnesota itself eventually shut down its own Gopher servers due to low utilization. The final “nail in the coffin” for Gopher occurred in 2002, when a security vulnerability related to Gopher was discovered in Internet Explorer, and Microsoft chose to simply remove Gopher support from the product rather than fix the problem. Today, Gopher is still around, but is a niche protocol used only by a relatively small group of enthusiasts and a handful of organizations that have a past history of using it.



Key Concept: The Gopher Protocol is a distributed document search and retrieval protocol that was developed at the University of Minnesota in the late 1980s. Resources are stored on Gopher servers, which organize information using a hierarchical directory structure. Gopher clients access servers to retrieve directory listings of available resources, which are presented to the user as a menu from which an item may be selected for retrieval. Gopher’s chief advantage is simplicity and ease of use, but it lacks flexibility in presentation and the ability to effectively present graphics and multimedia. For this reason, despite Gopher predating the World Wide Web, the Web has almost entirely replaced it, and Gopher is now a niche protocol.



TCP/IP Interactive and Remote Application Protocols

When it comes to TCP/IP applications, [file and message transfer applications](#) such as [electronic mail](#), [FTP](#) and the [World Wide Web](#) get the most attention, because they are the ones used most often on modern internetworks. Another category of TCP/IP application protocols that is less-well-known is the group that allows users to interactively access and use other computers directly over an internetwork, such as the public Internet. These applications are not often employed by end-users today but are still important—both from a historical perspective, and because of their usefulness in certain circumstances, especially to network administrators.

In this section, I provide a brief description of the “classical” interactive and remote application protocols used in TCP/IP. The first subsection describes the Telnet Protocol, one of the earliest and most important application protocols in TCP/IP, still used today both for remote device access and as the basis of communication of many other protocols. The second describes the Berkeley remote access family, often called the “r” commands or protocols because their command names begin with that letter. Finally, I provide a brief overview of the Internet Relay Chat (IRC) protocol, the original interactive chat application of the Internet and one still used widely today.

Telnet Protocol

In the very earliest days of internetworking, one of the most important problems that computer scientists needed to solve was how to allow someone operating one computer to access and use another as if he or she were connected to it locally. The protocol created to meet this need was called *Telnet*, and the effort to develop it was tied closely to that of the Internet and TCP/IP as a whole. Even though most Internet users today never invoke the Telnet protocol directly, they use some of its underlying principles indirectly all the time. Every time you send a piece of e-mail, use FTP to transfer a file, or load a Web page, you are using technology based on Telnet. For this reason, the Telnet protocol can make a valid claim to the title of the most historically important application protocol in TCP/IP.

In this section, I describe the operation of the Telnet protocol. I begin with an overview and history of the protocol and a discussion of the standards that define it. I describe the general operation of Telnet clients and servers and how connections are made and maintained. I then explain the important concept of the Network Virtual Terminal (NVT), Telnet's protocol commands, and how interrupts are handled using Telnet's special synch function. I conclude with a detailed look at Telnet's options and how they are negotiated.



Background Information: A basic comprehension of the [Transmission Control Protocol \(TCP\)](#), especially its [sliding window mechanism](#) and [flow control feature](#), will be helpful in understanding this section.

Telnet Overview, History and Standards

The description of internetworking protocol suites such as TCP/IP is most often done from the lower layers working upward, just as I have done in this Guide. While this makes sense for a number of reasons—most notably, the protocols are easier to understand this way—this does not reflect the history of how many protocol suites were developed. Applications in fact often come first: they are defined to meet the needs of users, and the rest of the suite is developed to enable the application to run. Telnet and TCP/IP represent a good example of this “top-down” process.

The history of Telnet actually goes back over a decade before the modern TCP/IP protocol suite that we know today. As I mentioned in [my overview of the File Transfer Protocol \(FTP\)](#), the early developers of TCP/IP internetworking technologies identified two overall application needs for networks to fill: enabling *direct access* and *indirect access* to resources. FTP was created for indirect access, by allowing a user to retrieve a resource from a remote host, use it locally, and if desired, copy it back to its source. Telnet was designed for direct access: to let a user access a remote machine and use it as if he or she were connected to it locally.

The Motivation for Telnet's Development

Understanding why Telnet was needed requires us to remember the nature of computing at the time the protocol was initially developed: the late 1960s. This was well before the era of the small personal computers that so many of us use exclusively today. All computers of that period were large and usually shared by many users. To work on a computer, you had to access a physical terminal connected to that machine, which was usually specially tailored to the needs and requirements of the host.

There were two specific issues that resulted from this situation. The first was that if you had several different computers in an organization, each user would need a separate terminal to access each computer he or she needed to use. This was expensive and inefficient; I can recall reading a quote from a book that compared this situation to having a room containing a number of television sets, each of which could only display a single channel.

The second and perhaps more significant issue was the difficulty in allowing a user at one site to access and use a machine at another. The only method at the time for accomplishing this was to install a dedicated data circuit from the site of the computer to the site of the user, to connect the user's terminal to the remote machine. Again, each circuit would only enable access to one machine. Every combination of user and computer would have required a separate, expensive circuit to be installed and maintained.

The solution to both of these issues was to create a more general way of allowing any terminal to access any computer. The underlying internetwork would provide the mechanism for communicating information between computers; this became the physical network connecting sites and the TCP/IP protocol suite connecting networks. On top of this would run an application protocol that allowed a user to establish a session to any networked computer and use it: the *Telnet* protocol.

Telnet History

Telnet was the first application protocol demonstrated on the fledgling ARPAnet, in 1969. The first RFC specifically defining Telnet was RFC 97, *First Cut at a Proposed Telnet Protocol*, published in February 1971. Development of Telnet continued throughout the 1970s, with quite a number of different RFCs devoted to revisions of the protocol and discussions of issues related to it. It took many years to refine Telnet and resolve all the difficulties that were associated with its development.

The final version of the protocol, *Telnet Protocol Specification*, was published as RFC 854 in May 1983. Over the years other RFCs have been published to clarify the use of the protocol and address various issues such as authentication. There are also a number of other RFCs that define [Telnet options](#), as we will see later in this section.

Fundamental Telnet Concepts

At first glance, it may be surprising that Telnet took so long to develop, because in theory, it should be a very simple protocol to define: all it needs to do is send keystrokes and program output over the network like any other protocol. This would be true if every terminal

and computer used the same communication method, but they do not. Telnet becomes complicated because it needs to allow a terminal from one manufacturer to be able to talk to a computer that may use a very different data representation.

Telnet solves this problem by defining a method that ensures compatibility between terminal types and computers while allowing special features to be used by computers and terminals that agree to support them. The protocol is built upon a foundation of three main concepts:

- ① **The Network Virtual Terminal (NVT):** Telnet defines a standardized, fictional terminal called the *Network Virtual Terminal (NVT)* that is used for universal communication by all devices. A Telnet client takes input from a user and translates it from its native form to the NVT format to send to a Telnet server running on a remote computer; the server translates from NVT to whatever representation the computer being accessed requires. The process is reversed when data is sent from the remote computer back to the user. This system allows clients and servers to communicate even if they use entirely different hardware and internal data representations. Special Telnet commands are interspersed with the data to allow the client and server devices to perform various functions needed to manage the operation of the protocol.
- ② **Options and Option Negotiation:** Having Telnet clients and servers act as NVTs avoids incompatibilities between devices, but does so by stripping all terminal-specific functionality to provide a common base representation that is understood by everyone. Since there are many cases where more intelligent terminals and computers may wish to use a more advanced communication feature or service, Telnet defines a rich set of options and a mechanism by which a Telnet client and server can negotiate their use. If the client and server agree on the use of an option it can be enabled; if not, they can always fall back on the NVT to ensure basic communication.
- ③ **Symmetric Operation:** While Telnet is a client/server protocol, it is specifically designed to not make assumptions about the nature of the client and server software. Once a Telnet session is established, they can each send and receive data as equals. They can also each initiate the negotiation of options. This makes the protocol extremely flexible, and has led to its use in a variety of places, as we will discuss in a moment.

Telnet Applications

Telnet is most often associated with remote login, which is its most common traditional use. A user typically uses a Telnet client program to open a Telnet connection to a remote server, which then treats the Telnet client like a local terminal, allowing the user to log in and access the server's resources as if he or she were using a directly-attached terminal. Telnet is still used this way quite extensively by UNIX users, who often need to log in to remote hosts from their local machines; I myself use Telnet in this manner every day to access a machine hundreds of miles away. However, this use of Telnet is not nearly as common amongst the majority of Internet users who work on Windows or Apple computers where network resources are accessed not through direct login but by other means.

However, while remote login is a big part of what Telnet is about, it's important to note that the protocol was not inherently designed for that specific function. When Telnet is used to access a remote device, the protocol itself is only used to set up the connection between the client and server machines, encode data to be transmitted according to the rules of the

Telnet NVT, and facilitate the negotiation and use of options. It is the client and server devices themselves that decide whether Telnet is used for remote access or for some other purpose.

Telnet's Legacy

Telnet's flexibility, combined with its age in the TCP/IP suite, has led to Telnet being adopted for a variety of other protocols. Since Telnet doesn't make assumptions about what a client is and what a server is, any program or application can use it. Many of the file and message transfer applications, including [FTP](#), [SMTP](#), [NNTP](#) and [HTTP](#), communicate through the sending of text commands and messages, and use the Telnet's NVT specification to ensure the compatibility of communication between devices. They don't actually establish Telnet sessions or use features like option negotiation, they just send data in a manner consistent with how Telnet works.

Thus, even though modern Internet users may never intentionally invoke Telnet specifically, they use it indirectly every time they send or receive e-mail or browse the Web. Administrators can even use Telnet client software to access devices such as FTP and HTTP servers and send them commands manually.



Key Concept: *Telnet* is one of the oldest protocols in the TCP/IP suite, first developed in the 1960s to allow a user on one computer system to directly access and use another. It is most often used for remote login, with Telnet client software on a user's machine establishing a session with a Telnet server on a remote host to let the user work with the host as if connected directly. To ensure compatibility between terminals and hosts that use different hardware and software, communication between Telnet client and server software is based on a simplified, fictional data representation that can be enhanced through the negotiation of options.

Telnet Connections and Client/Server Operation

Telnet's overall function is to define a means by which a user or process on one machine can access and use another machine as if it were locally connected. This makes Telnet inherently client/server in operation, like so many other application protocols in TCP/IP. Usually, the Telnet client is a piece of software that acts as an interface to the user, processing keystrokes and user commands and presenting output from the remote machine. The Telnet server is a program running on a remote computer that has been set up to allow remote sessions.

TCP Sessions and Client/Server Communication

Telnet is used for the interactive communication of data and commands between client and server over a prolonged period of time, and is thus strongly based on the concept of a *session*. For this reason, Telnet runs over the connection-oriented [Transmission Control Protocol \(TCP\)](#). Telnet servers listen for connections on [well-known TCP port](#) number 23.

When a client wants to access a particular server, it initiates a TCP connection to the appropriate server, which responds to set up a TCP connection using the standard [TCP three-way handshake](#).

The TCP connection is maintained for the duration of the Telnet session, which can remain alive for hours, days, or even weeks at a time. The [quality of service features of TCP](#) guarantee that data is received reliably and in order, and ensures that data is not sent at too high a rate for either client or server. A machine offering Telnet service can support multiple simultaneous sessions with different users, keeping each distinct by [identifying it using the IP address and port number of the client](#).

Since TCP is a [full-duplex protocol](#), both client and server can send information at will over the Telnet session. By default, both devices begin by using the standard [Telnet Network Virtual Terminal \(NVT\)](#) method for encoding data and control commands. They can also negotiate the use of [Telnet options](#) to provide greater functionality for the session. While option negotiation can occur at any time, it is normal for there to be a “burst” of such option exchanges when a Telnet session is first established, and only occasional option command exchanges thereafter.

With the TCP connection in place and the Telnet session active, the client and server software begin their normal jobs of interfacing the user to the remote host. To the user, the Telnet session appears fundamentally the same as sitting down at a terminal directly connected to the remote host. In most cases, the server will begin the user’s session by sending a login prompt to ask for a user name and password. The Telnet client will accept this information from the user and send it to the server. Assuming the information is valid, the user will be logged in and can use the host in whatever manner his or her account authorizes.

As mentioned in [the Telnet overview](#), even though the protocol is classically intended for remote login, it need not be used in this manner. The administrator of the computer that is running the Telnet server determines how it is to be used on that machine. As just one example, a Telnet server can be interfaced directly to a process or program providing a service. I can recall years ago using an Internet server that provided weather information to the public using Telnet. After using the protocol to connect to that machine, you would be presented not with a login prompt, but a menu of weather display options. Of course today, [the Web](#) has replaced most of such facilities, as it is far better-suited to this type of information retrieval.



Key Concept: Telnet is a client/server protocol that uses TCP to establish a session between a user terminal and a remote host. The Telnet client software takes input from the user and sends it to the server, which feeds it to the host machine’s operating system. The Telnet server takes output from the host and sends it to the client to display to the user. While Telnet is most often used to implement remote login capability, there is no concept specifically pertaining to logins in the protocol, which is general enough to allow it to be used for a variety of functions.

Use of Telnet To Access Other Servers

The Telnet NVT representation is used by a variety of other protocols such as SMTP and HTTP. This means that the same Telnet client that allows you to access a Telnet server can be used to directly access other application servers. All you need to do is specify the port number corresponding to the service. For example, this command will allow you to directly interface to a Web server:

```
telnet www.someserversomewhere.org 80
```

You will not receive a login prompt, but instead the server will wait for you to send an [HTTP Request message](#), as if you were a Web browser. If you enter a valid request, the server will send you an [HTTP Response message](#). Used in this way, Telnet can be very valuable as a diagnostic tool.



Key Concept: The Telnet Network Virtual Terminal (NVT) data representation has been adopted by a host of other TCP/IP protocols as the basis for their messaging systems. Telnet client software can thus be used not only to connect to Telnet servers, but also to servers of protocols such as SMTP and HTTP, which is useful for diagnostic purposes.

Telnet Communications Model and the Network Virtual Terminal (NVT)

At its heart, Telnet is a rather simple protocol. Once a TCP connection is made and the Telnet session begins, the only real task that the client and server software has is to capture input and output, and redirect it over the network. So, when the user types a key on his local terminal, the Telnet client software captures it and sends it over the network to the remote machine. There, the Telnet server software sends it to the operating system, which treats it as if it had been typed locally. When the operating system produces output, the process is reversed: Telnet server software captures the output and sends it over the network to the user's client program, which displays it on the printer or monitor.

To invoke two well-known clichés, I could say that this “looks good on paper”, but that “the devil is in the details”. This simplified implementation would only work if every computer and terminal used the exact same hardware, software and data representation. Of course, this is far from the case today, and was even worse when Telnet was being developed.

The Problem of Differing Representations

Computers back in the “good old days” were highly proprietary, and not designed to interoperate. They differed in numerous ways, from the type of keyboard a terminal used and the keystrokes it could send, to the number of characters per line and lines per screen on a terminal, to the character set used to encode data and control functions. In short, computer *A* was designed to accept input in a particular form from its own terminals, and not those of Computer *B*.

This is actually a fairly common issue in the world of networking, and one to which we can draw a real-world analogy to help explain the problem and how it may be solved. Suppose that an important international conference was attended by 30 ambassadors from different nations, each of which had one assistant. Every ambassador and assistant pair spoke only their own language and thus could only speak to each other—just like a computer and terminal designed to interface only to each other.

To allow the assistant from one country to speak to the ambassador from the others, one solution would be to train the assistants to speak the languages of all the other attending nations. Back in the computing world, this would be like defining the Telnet protocol so that every Telnet client software implementation understood how to speak to every computer in existence. In both cases, this would work, but would be quite impractical and difficult to do.

An alternative approach is to define a single common language and have all the ambassadors and assistants learn it. While this would require some work, it would be a lot less than requiring people to learn dozens of languages. Each ambassador and assistant would speak both his or her native language and this chosen common language. Each could communicate with all of the others using this common language, without having to know all of the languages that might be used by anyone at the conference. Even more importantly, if an ambassador and assistant showed up at the conference speaking a new, 31st language, all the other delegates wouldn't need to learn it.

The Network Virtual Terminal

Telnet uses an approach similar to the analogy described above for dealing with its problem of hardware and software compatibility. Rather than having terminals and hosts communicate using their various native “languages”, all Telnet clients and servers agree to send data and commands that adhere to a fictional, “virtual” terminal type call the *Network Virtual Terminal (NVT)*. The NVT defines a set of rules for how information is formatted and sent, such as character set, line termination, and how information about the Telnet session itself is sent.

Each Telnet client running on a terminal understands both its native language and NVT. When information is entered by the user on his or her local terminal, it is converted to NVT for transmission over the network in NVT form. When the Telnet server receives this information, it translates it from NVT to the format that the remote host expects to receive it. The identical process is performed for transmissions from the server to the client, in reverse. This is illustrated in [Figure 320](#).



Key Concept: The Telnet *Network Virtual Terminal (NVT)* is a uniform data representation that ensures the compatibility of communication between terminals and hosts that may use very different hardware, software and data formats. The Telnet client translates user input from the terminal's native form to NVT for transport to the Telnet server, where it is converted to the host's internal format. The process is reversed for output from the host to the user.

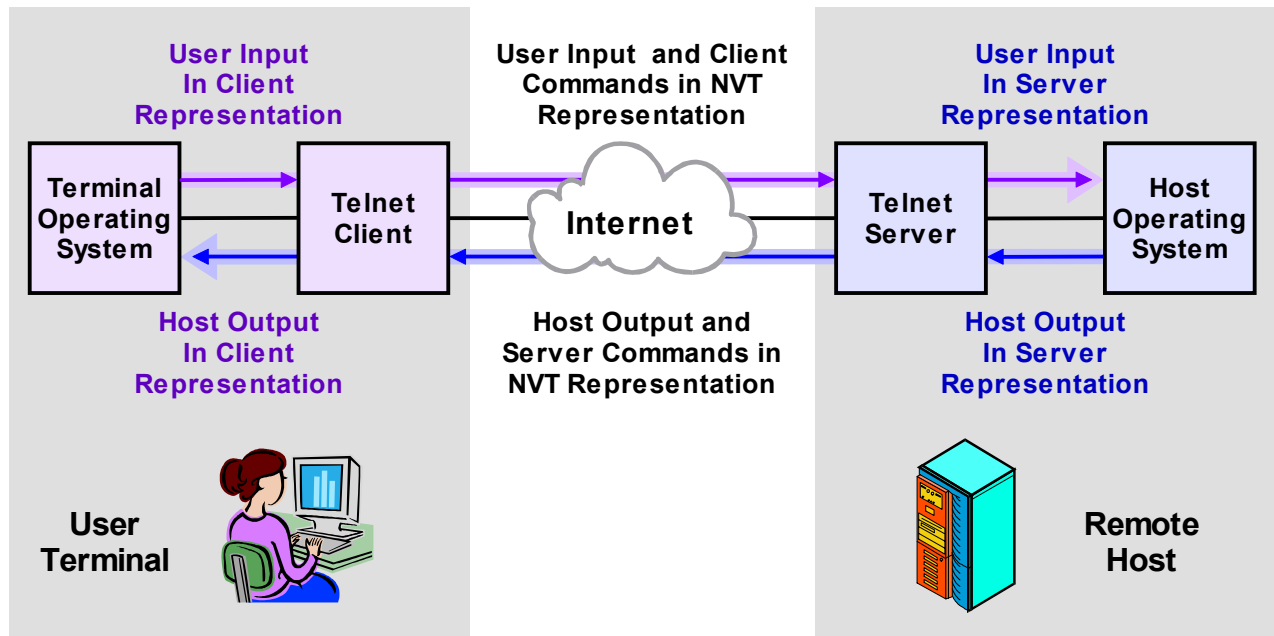

Figure 320: Telnet Communication and the Network Virtual Terminal (NVT)

Telnet uses the Network Virtual Terminal (NVT) representation to allow a user terminal and remote host that use different internal formats to communicate.

The NVT is defined to consist of a logical “keyboard” for input and a logical “printer” for output (the age of the protocol is reflected in these terms; decades ago there were no monitors, all output was on paper). NVT uses the 7-bit *United States ASCII (USASCII)* character set. Each character is encoded using one 8-bit byte. Note however that a client and server can use [Telnet options](#) to negotiate other data representations, including the transmission of either extended ASCII or even full 8-bit binary data.

NVT ASCII Control Codes

Regular ASCII consists of 95 regular, “printable” characters (codes 32 through 126) and 33 control codes (0 through 31 and 127). The Telnet standard specifies that the output device must be able to handle all the printable characters, and it mandates how several of the other common ASCII control codes should be interpreted. Of these codes, three (0, 10 and

13) are required to be accepted by all Telnet software; five others are optional, but if supported, must be interpreted in a manner consistent with the Telnet specification. They are all described in [Table 281](#).

Table 281: Interpretation of Standard Telnet NVT ASCII Control Codes

ASCII Value (Decimal)	ASCII Character Code	ASCII Character	Description	Support Optional / Mandatory
0	NUL	Null	No operation (no effect on output).	Mandatory
7	BEL	Bell	Produces an audible or visible signal on the output without moving the print head. This notification may be used to get the user's attention, as in the case of an error.	Optional
8	BS	Back Space	Moves the print position one character to the left.	Optional
9	HT	Horizontal Tab	Moves the printer to the next horizontal tab stop. The standard does not specify how devices agree on tab stop positions; this can be negotiated using Telnet options.	Optional
10	LF	Line Feed	Moves the printer to the next line, keeping the print position the same.	Mandatory
11	VT	Vertical Tab	Moves the print line to the next vertical tab stop. As with the "HT" character, devices must use an option to come to an agreement on vertical tab stop positions.	Optional
12	FF	Form Feed	Moves the printer to the top of the next page (or on a display, clears the screen and positions the cursor at the top.)	Optional
13	CR	Carriage Return	Moves the printer to the left margin of the current print line.	Mandatory

End-of-Line Representations

The Telnet NVT scheme defines the combination of the carriage return ("CR") and line feed ("LF") characters to represent the end of a line of ASCII text. The literal meaning of these two characters is "return to the left margin" (from the "CR") and "go to the next line" (from the "LF"). However, NVT treats the "CR+LF" sequence as more than just two independent characters; they are taken collectively to define a *logical* "end of line" character. This is necessary because not all terminal types define an end of line using both "CR" and "LF". Translation of end-of-line characters between the native and NVT formats is one of the functions that Telnet client and server software must perform to ensure compatibility between terminals and hosts.



Key Concept: The Telnet NVT format is based on 7-bit US ASCII, with each byte carrying one character. The standard specifies that devices must handle all standard printable ASCII characters, as well as three mandatory control characters. Two of these are the carriage return (“CR”) and line feed (“LF”) characters; when combined, these define the logical end of a line of text. The Telnet standard also describes the interpretation of five other optional ASCII control characters.

Half-Duplex and Full-Duplex Modes

Another artifact of the age of Telnet is that for maximum compatibility, the Network Virtual Terminal specification is designed under the assumption of **half-duplex operation**: only one device can transmit at a time. A device that is sending data is supposed to end its transmission with the special Telnet *Go Ahead* command, telling the other device that it may now transmit ([the next topic describes Telnet protocol commands](#)). This is similar to how people using walkie-talkies end each transmission with “over” to tell their partner that they may now respond.

Of course, modern networks operate in a full-duplex mode, and using half-duplex communication would be needlessly inefficient. In most cases the Telnet client and server agree to use an option (*Suppress Go Ahead*) that eliminates the need to send this command. However, having this as the default is a good example of how NVT acts as a “least common denominator” in Telnet, in case the simpler operating mode is needed by either device.

Telnet Protocol Commands

Most of the input that a user enters at a terminal takes the form of data and commands that are sent to the application program he or she is using. However, computer systems also provide a means by which a user can instruct the terminal to send certain commands that control how the terminal itself operates, and how it interacts with the computer to which it is connected. The best example of this is the command to interrupt a process, which is usually sent by pressing a special key or key combination on the user terminal.

Telnet needs to have a way to allow such commands to be entered by the user. However, here we run into the same problem that we saw in [the last topic](#), when we talked about the communication of data between terminals and computers: a lack of uniformity in representation. While all terminals and computers support the ability to interrupt a running program, for example, they may each use a different keystroke to represent it. For example, on most UNIX systems, the key combination “<Ctrl>+C” interrupts a program, but typing this on a Windows system will not (it usually represents instead the “copy data” function!)

Defining a Universal Representation for Standard Command Functions

Since the problem is the same as the one we ran into in representing data flow, it’s not too surprising that the solution is the same: the use of a universal representation for a set of standard commands to be passed between the terminal and host computer. All keystrokes

that represent these commands are translated to the standard Telnet codes for transmission, and then translated to the specific needs of the host computer. So to take our example again, if a user presses “<Ctrl>+C” on a UNIX terminal where this is defined as the interrupt function, then instead of sending that exact keystroke, the Telnet client sends the special Telnet *Interrupt Process* command, which is translated by the Telnet server to the command code appropriate for the connected host.

The Telnet standard includes a number of these special codes to allow a user to control the operation of the remote computer. It also defines a set of commands that are specific to the Telnet protocol itself; these let the Telnet client and Telnet server software communicate. Collectively, these are called Telnet *protocol commands*.

Escaping Commands and the Interpret As Command (IAC) Character

All Telnet commands are sent in the same communication stream as regular data; they are represented using special byte values in the range from 240 to 254. To differentiate between data bytes of these values and Telnet commands, every command is preceded by a special *escape character*, given the name *Interpret As Command (IAC)*. IAC has a value of 255; when the recipient sees this character, it knows the next byte is a command and not data. So, since the Telnet *Interrupt Process* command has the value 244, to send this command the Telnet client would transmit the byte 255 and then 244. If the actual data byte value 255 needs to be sent, it is transmitted as two 255 bytes. Some Telnet commands also include additional bytes data, which are sent after the command code itself; a good example is the use of parameters in [Telnet option negotiation](#).

You may be wondering at this point why the IAC character is needed at all. After all, Telnet uses US ASCII, which is 7-bit data in the byte range of 0 to 127, and the Telnet commands have values higher than 127. One general rationale for using the IAC escape is to be explicit that a command is being sent. A more specific reason is to accommodate the optional sending of 8-bit binary data over Telnet, which the client and server can negotiate. If this mode were enabled and commands were not preceded by the IAC character, this would require all data bytes with values from 240 to 255 to be somehow marked so they would be interpreted as data and not commands. It is more efficient to include an extra byte for commands than data, since they are sent less frequently. By escaping commands, only data byte value 255 requires two bytes to be sent.



Key Concept: The Telnet protocol defines a set of *protocol commands* that are used for two purposes: first, to represent standard control functions that need to be sent between a terminal and host, such as the command to interrupt a process; and second, to enable protocol communication between the Telnet client and server software. Protocol commands are sent in the normal data communication stream over the Telnet session’s TCP connection. Each is represented by a byte value from 240 to 254, and is preceded by the *Interpret As Command (IAC)* command, byte value 255, which tells the recipient that the next byte in the stream is a command.

Telnet Protocol Command Codes

Table 282 lists the Telnet protocol commands in numerical byte value order, showing for each its command code and name and describing its meaning and use.

Table 282: Telnet Protocol Commands (Page 1 of 2)

Command Byte Value (Decimal)	Command Code	Command	Description
240	<i>SE</i>	Subnegotiation End	Marks the end of a Telnet option subnegotiation, used with the <i>SB</i> code to specify more specific option parameters. See the topic on Telnet options for details.
241	<i>NOP</i>	No Operation	Null command; does nothing.
242	<i>DM</i>	Data Mark	Used to mark the end of a sequence of data that the recipient should scan for urgent Telnet commands. See the topic on Telnet interrupt handling for more information.
243	<i>BRK</i>	Break	Represents the pressing of the “break” or “attention” key on the terminal.
244	<i>IP</i>	Interrupt Process	Tells the recipient to interrupt, abort, suspend or terminate the process currently in use.
245	<i>AO</i>	Abort Output	Instructs the remote host to continue running the current process, but discard all remaining output from it. This may be needed if a program starts to send unexpectedly large amounts of data to the user.
246	<i>AYT</i>	Are You There	May be used to check that the remote host is still “alive”. When this character is sent the remote host returns some type of output to indicate that it is still functioning.
247	<i>EC</i>	Erase Character	Instructs the recipient to delete the last undeleted character from the data stream. Used to “undo” the sending of a character.
248	<i>EL</i>	Erase Line	Tells the recipient to delete all characters from the data stream back to (but not including) the last end of line (“CR”+“LF”) sequence.
249	<i>GA</i>	Go Ahead	Used in Telnet half-duplex mode to signal the other device that it may transmit.
250	<i>SB</i>	Subnegotiation	Marks the beginning of a Telnet option subnegotiation, used when an option requires the client and server to exchange parameters. See the topic on Telnet options for a full description.
251	<i>WILL</i>	Will Perform	In Telnet option negotiation , indicates that the device sending this code is willing to perform or continue performing a particular option.

Table 282: Telnet Protocol Commands (Page 2 of 2)

Command Byte Value (Decimal)	Command Code	Command	Description
252	<i>WON'T</i>	Won't Perform	In Telnet option negotiation , indicates that the device sending this code is either not willing to perform a particular option, or is now refusing to continue to perform it.
253	<i>DO</i>	Do Perform	In Telnet option negotiation , requests that the other device perform a particular option or confirms the expectation that the other device will perform that option.
254	<i>DON'T</i>	Don't Perform	In Telnet option negotiation , specifies that the other party not perform an option, or confirms a device's expectation that the other party not perform an option.
255	<i>IAC</i>	Interpret As Command	Precedes command values 240 through 254 as described above. A pair of IAC bytes in a row represents the data value 255.

Perhaps ironically, the Telnet command are not used as much today as they were when Telnet was in its early days, because many of the compatibility issues that we discussed earlier no longer exist. ASCII has become the standard character set of the computing world, so many of the functions such as aborting output or interrupting a process no longer require the use of Telnet commands. They are still widely used, however, for internal Telnet operations such as option negotiation.

Telnet Interrupt Handling Using Out-Of-Band Signaling: The Telnet Synch Function

All the bytes of data sent from a Telnet client to a server are received in the order that they were sent, and vice-versa. This is, of course, the way we expect an application to operate; in fact, ensuring that data is not received out-of-order is one of the jobs that we assume of [the reliable transport protocol TCP](#), over which Telnet runs. However, this can cause a problem for Telnet because of the way the protocol sends both data and commands over the same connection.

The Problem: Sending an Interrupt Command

The most important case where the issue of all data being received in order arises is when a user needs to interrupt a process. Suppose as an example that you are using Telnet to run an interactive program that takes user input, processes it, and then produces output. You are merrily typing away when you notice that you haven't seen any output from the program for a while. It has apparently hung up due to a programming error or other glitch.

If you were using the program on a directly-connected terminal, you would simply use the key or keystroke command appropriate to that terminal to interrupt or kill the process and restart it. Instead, you are using Telnet, so you enter the appropriate keystroke, which gets converted to the special Telnet *Interrupt Process* command code (byte value 244, preceded by the Telnet *Interpret As Command* code, 255).

Since Telnet uses only a single stream for commands and data, that code is placed into the [TCP data stream](#) to be sent over to the Telnet server. Since you were entering data for a while, that Telnet *Interrupt Process* code will be sitting behind a bunch of regular data bytes. Now, the remote process has stopped reading this data, which means the TCP receive buffer on the server will start to fill up. The *Interrupt Process* command will thus remain stuck in the buffer, waiting to be read. In fact, if the number of data bytes in front of the command is high enough, the TCP buffer on the server may fill entirely, causing the server to [close the client's TCP send window](#). This means the *Interrupt Process* command will wait in the client's outgoing TCP queue and never even be sent to the remote host at all!

Obviously, what we need here is some way to be able to flag the *Interrupt Process* command, so that it can be sent to the remote host regardless of the number of data bytes outstanding in front of it. If you've already perused [the large section of this Guide devoted to TCP](#), you may now be thinking that you have already read about a feature of that protocol that seems ideally suited for this exact problem... and you'd be correct! [The TCP "urgent" function](#) allows an important piece of data to be marked so that it is given priority over regular data, a process sometimes called *out-of-band signaling* (because the signal is "outside" the normal data stream). Telnet makes use of this feature of TCP to define what it calls the *synch function*.

The Synch Function

When needed, as in the example just described, the synch function is invoked by the client sending the special *Telnet Data Mark (DM)* protocol command, while instructing its TCP layer to mark that data "urgent". The *URG* bit in the [TCP segment](#) carrying this command causes it to bypass TCP's normal flow control mechanism so it is sent over to the remote host. The Telnet server software, seeing the synch in the data stream, then searches through all of the data in its buffer looking only for Telnet control commands such as *Interrupt Process*, *Abort Output* and *Are You There*. These commands are then executed immediately. The server continues to search for important commands up to the point where the *Data Mark* command is seen. All intervening data is discarded; it will need to be retransmitted. After the *Data Mark* is processed, the server returns to normal operation.

It is also possible for the server to use the synch function in communication with the user on the client device. For example, if the user sends the *Abort Output* command to the server, he or she is telling the server to discard all remaining output from the current process. The server will stop sending that output, and can also use the synch function to clear all outstanding data that is waiting in buffers to be sent to the client machine (since it causes data to be discarded as mentioned above).



Key Concept: Telnet protocol commands are sent in the same stream with user data, which means a problem with the remote host that stops the flow of data might cause user commands to become backed up and never received by the host. Since this may include commands issued by the user to try to fix the problem on the host, this can be a serious problem. To alleviate this situation, Telnet includes the *synch* function, which uses TCP's urgent data transmission feature to force the receipt of essential commands even when regular data is not being processed.

Telnet Options and Option Negotiation

The basic [Telnet Network Virtual Terminal \(NVT\)](#) specification solves the problem of compatibility between different terminal and computer types by defining a common representation for data and commands that every Telnet client and server uses. The price for this universal representation, however, is very high: all of the advanced or special capabilities of terminals and hosts is stripped off. The result is a language that everyone can speak, but that is not capable of much more than basic conversation.

The creators of Telnet recognized that while it was important to define NVT as a common base to ensure cross-device compatibility, it was also essential that some means be provided by which clients and servers could agree to use more advanced means of communication. They defined a set of *Telnet options*, and a mechanism by which a Telnet client and server can *negotiate* which options they want to use.

Most Telnet options are used for the purpose of improving the efficiency of how data is transferred between devices. For example, by default the NVT assumes half-duplex operation with each device needing to use the *Go Ahead* command after each transmission. However, virtually all hardware now supports full-duplex communication, so devices will usually agree to use the *Suppress Go Ahead* option to eliminate the need to send this character. Similarly, it is possible for devices to negotiate the sending of 8-bit binary data instead of the standard 7-bit ASCII of the Telnet NVT.

The process of Telnet option negotiation is described in the main Telnet standard document, RFC 854, as well as a companion document, RFC 855 ([Telnet Option Specifications](#)). The options themselves are described in a separate set of Internet standards. Several of these were published at the same time as RFCs 854 and 855; others were defined earlier as part of previous versions of Telnet, and still others have been added over the years. There are now several dozen different Telnet options in existence; a master list is maintained by [IANA](#) (like all other TCP/IP parameters).



On The Web: An up-to-date listing of all Telnet options can be found on the IANA Web site at: <http://www.iana.org/assignments/telnet-options>

Common Telnet Options

Each Telnet option is identified using a decimal byte code with a possible value of 0 to 254; the value 255 is reserved to extend the option list should more than 255 options ever be needed. Each option also has a text code string associated with it, which is often used as a symbol in place of the code number in both protocol discussions and diagnostic output.

[Table 283](#) lists some of the more interesting Telnet options and provides a brief description of each.

Table 283: Common Telnet Options (Page 1 of 2)

Option Number	Option Code	Option Name	Description	Defining RFC
0	TRANSMIT-BINARY	Binary Transmission	Allows devices to send data in 8-bit binary form instead of 7-bit ASCII.	856
1	ECHO	Echo	When you press a key on a terminal, you also expect to see the character you entered appear on the terminal screen as output; this is called <i>echoing</i> the input. Echoing is a significant issue in terminal applications because it can be implemented in a number of different ways. This option allows devices to negotiate any of a variety of different echo modes.	857
3	SUPPRESS-GO-AHEAD	Suppress Go Ahead	Allows devices not operating in half-duplex mode to no longer need to end transmissions using the Telnet <i>Go Ahead</i> command.	858
5	STATUS	Status	Lets a device request the status of a Telnet option.	859
6	TIMING-MARK	Timing Mark	Allows devices to negotiate the insertion of a special timing mark into the data stream, which is used for synchronization.	860
10	NAOCRD	Output Carriage-Return Disposition	Lets the devices negotiate how carriage returns will be handled.	652
11	NAOHTS	Output Horizontal Tab Stops	Allows the devices to determine what horizontal tab stop positions will be used for output display.	653
12	NAOHTD	Output Horizontal Tab Stop Disposition	Allows the devices to negotiation how horizontal tabs will be handled and by which end of the connection.	654
13	NAOFFD	Output Formfeed Disposition	Allows the devices to negotiation how form feed characters will be handled.	655
14	NAOVTS	Output Vertical Tabstops	Used to determine what vertical tab stop positions will be used for output display.	656

Table 283: Common Telnet Options (Page 2 of 2)

Option Number	Option Code	Option Name	Description	Defining RFC
15	<i>NAOVTD</i>	Output Vertical Tab Disposition	Lets devices negotiation the disposition of vertical tab stops.	657
16	<i>NAOLFD</i>	Output Linefeed Disposition	Allows devices to decide how line feed characters should be handled.	658
17	<i>EXTEND-ASCII</i>	Extended ASCII	Lets devices agree to use extended ASCII for transmissions and negotiate how it will be used.	698
24	<i>TERMINAL-TYPE</i>	Terminal Type	Allows the client and server to negotiate the use of a specific terminal type. If they agree, this allows the output from the server to be ideally customized to the needs of the particular terminal the user is working on.	1091
31	<i>NAWS</i>	Negotiate About Window Size	Permits communication of the size of the terminal window.	1073
32	<i>TERMINAL-SPEED</i>	Terminal Speed	Allows devices to report on the current terminal speed.	1079
33	<i>TOGGLE-FLOW-CONTROL</i>	Remote Flow Control	Allows flow control between the client and the server to be enabled and disabled.	1372
34	<i>LINEMODE</i>	Linemode	Allows the client to send data one line at a time instead of one character at a time. This improves performance by replacing a large number of tiny TCP transmissions with a smaller number of larger ones.	1184
37	<i>AUTHENTICATION</i>	Authentication	Lets the client and server negotiate a method of authentication to secure connections.	1416



Key Concept: The Telnet NVT specification ensures that all devices using Telnet can talk to each other, but accomplishes this by boiling down communication to the simplest of representations. To allow the use of more sophisticated formats and services, Telnet defines a number of *options*. If a client and server both implement a particular option, they can enable its use through a process of *negotiation*.

Enabling Options Using Negotiation

The first stage in Telnet option negotiation is for the client and server to decide whether or not they want to enable a particular option. One of the aspects of Telnet's symmetry of operation is that either device may choose to initiate the use of an option. The initiating

device may either specify that it wants to start using an option, or that it wants the other device to start using it. The responding device may either agree or disagree in either case; an option can only be enabled if both devices agree to its use.

This negotiation is performed using four Telnet protocol commands, as follows:

- ① **WILL:** Sent by the initiator to indicate that it wants to start using a particular option. There are two possible replies by the responding device:
 - ① **DO:** Sent to indicate agreement that the initiator should use the option; it is then considered enabled.
 - ① **DONT:** Sent to specify that the initiator must not use the option.
- ① **DO:** Sent by the initiator to request that the other device start using an option. That device may respond in two ways:
 - ① **WILL:** Sent to specify that the responding device will agree to use the option; the option is enabled.
 - ① **WONT:** Sent to tell the initiator that the responder will not use the option requested.

The symmetry of Telnet, combined with the fact that both *DO* and *WILL* can be used either to initiate a negotiation or respond to one, make Telnet's option negotiation potentially complicated. Since either device can initiate negotiation of an option at any time, acknowledgment loops could potentially arise if both devices were to try to enable an option simultaneously, or get into a situation where each kept responding to the other's replies.

For this reason, the Telnet standard specifies restrictions on when the *WILL* and *DO* commands are used. One is that a device may only send a negotiation command to request a change in the status of an option; it cannot send *DO* or *WILL* just to confirm or reinforce the current state of the option. Another is that a device receiving a request to start using an option it is already using should not acknowledge it using *DO* or *WILL*.

Disabling Options

Since an option may only be activated if both devices agree to use it, either may disable the use of an option at any time by sending either of these commands:

- ① **WONT:** Sent by a device to indicate that it is going to stop using an option. The other device must respond with *DONT* as a confirmation.
- ① **DONT:** Sent by a device to indicate that it wants the other device to stop using an option. The other device must respond with *WONT*.



Key Concept: Either device may choose to negotiate the use of a Telnet option. The initiator uses the *WILL* command to specify that it wants to start using a particular option; if the other device agrees, it responds with *DO*; otherwise, it sends *DONT*. Alternately, the initiator can use the *DO* command to indicate that it wants the other device to start using an option; that device responds with *WILL* if it agrees to do so, or *WONT* if it does not. Either device may disable the use of an option at any time by sending the other a *WONT* or *DONT* command.

Option Subnegotiation

All of the *DO/DONT/WILL/WONT* stuff above only serves to enable or disable an option. Some options are only either off or on, in which case the negotiation above is sufficient. An example would be the binary transmission option, *TRANSMIT-BINARY*. Others require that after they are enabled, the client and server exchange parameters to control how the option works. For example, the *TERMINAL-TYPE* option requires some way for the client to send the server the name of the terminal.

Telnet allows the client and server to send an arbitrary amount of data related to the option using a process called *option subnegotiation*. A device begins this process by sending a special sequence of Telnet protocol commands and data. First the command *SB* is sent, followed by the option number and parameters as defined by the particular option; the end of the subnegotiation data is marked by the protocol command *SE*. Of course, both *SB* and *SE* must be preceded by the *Interpret As Command (IAC)* command byte.

So, let's take the terminal type option again as an example. Suppose the server supports this option and would like the client to use it. It will send:

IAC DO TERMINAL-TYPE



Note: I am showing the text mnemonics for convenience; this would really be sent as the three decimal bytes 255 253 24.

Assuming the client agrees, it will respond with:

IAC WILL TERMINAL-TYPE

Now the terminal type option is in effect, but the server still doesn't know what terminal the client is using. It can prompt the client to provide that information by sending this:

IAC SB TERMINAL-TYPE SEND IAC SE

The client, receiving this “subnegotiation” command, will respond with:

IAC SB TERMINAL-TYPE IS <some_terminal_type> IAC SE



Key Concept: The *WILL* and *DO* commands only turn on a Telnet option that a client and server agree to use. In some cases, an option requires additional information to be sent between the client and server device for it to function properly. This is accomplished through a process of *option subnegotiation*. Either device sends the other a set of data relevant to the option, bracketed by the *SB* (*subnegotiation*) and *SE* (*end subnegotiation*) Telnet protocol commands.



Berkeley Remote ("r") Commands

TCP/IP has achieved success in large part due to its universality: it has been implemented on virtually every major computing platform. While the suite is thus not specific to any operating system, there is no denying that its history is closely tied to a particular one—UNIX. Most of the computers on the early Internet used UNIX, and the development of TCP/IP has paralleled that of UNIX in a number of respects.

One of the most important organizations involved in the development of UNIX, and thus TCP/IP indirectly, was the University of California at Berkeley. Their well-known *Berkeley Software Distribution (BSD)* UNIX has been in widespread use for over 20 years. A set of commands was developed for BSD UNIX to facilitate various remote operation functions over a TCP/IP internetwork. Each of these programs begins with the letter “r” (for “*remote*”), so they have come to be known as both the *Berkeley remote commands* (or utilities) and also simply the “*r*” *commands*. Since their initial creation, they have been adopted for most variations of UNIX, and some other operating systems as well.

In this section I provide a brief description of the Berkeley remote protocols and how they are used. I begin with a discussion of the main protocol in this group, *rlogin*, and how it is used to enable remote host access. I then describe the remote shell program, *rsh*, and how it allows a command to be executed on a network host. I conclude with a brief summary of the other members of the “r” protocol family: *rcp*, *ruptime* and *rwho*.



Background Information: This section will probably make much more sense to those who have some understanding of the UNIX operating system than those who do not. I also make some reference to [Telnet](#) in this section so you may wish to have at least basic familiarity with that protocol.

Berkeley Remote Login (rlogin)

The “head” of the Berkeley remote protocol family is the remote login command, *rlogin*. As the name clearly implies, the purpose of this program is to allow a user on a UNIX host to log in to another host over a TCP/IP internetwork. Since Telnet is also often used for remote login, *rlogin* and Telnet are sometimes considered alternatives to each other for TCP/IP remote login. While they can be used in a very similar way, however, they are quite different in a few respects.

From a conceptual standpoint, Telnet is designed as a protocol to enable terminal/host communication. As I mentioned in [the Telnet overview topic](#), the protocol was not designed specifically for the purpose of remote login. In contrast, *rlogin* **was** intended for that specific purpose, and this is reflected in its operation.

***rlogin* Operation**

The protocol requires *rlogin* server software to be running on the host that is going to allow remote access; it is usually called *rlogind* (for *rlogin daemon*, the latter word being the standard UNIX term for a background server process). The server listens for incoming connection requests on TCP port 513. A user who wants to remotely log in to the server runs the *rlogin* command on his or her local host, and specifies the name of the server. The client makes a TCP connection to the server, and then sends to the server a string containing the following information:

- ① The login name of the user on the client machine.
- ② The login name that the user wants to use on the server (which is often the same as the user's login name on the client, but not always.)
- ③ Control information such as the type and speed of the terminal.

The server processes this information and begins the login process. It will normally prompt the user for a password to log in to the remote host. Assuming the password is correct, the user will be logged in to the remote host and can use it as if he or she were locally connected.

Comparing rlogin to Telnet

From a practical standpoint, the *rlogin* command is much simpler than Telnet; it does not support Telnet's full [command structure](#), nor capabilities such as [option negotiation](#). It does include a small set of commands, however. The client is able to send to the server one key piece of information: the current size of the terminal window in use. The server is able to tell the client to turn on or off flow control, request that the client send it the current window size, or flush pending output that the server has sent, up to a certain point in the data stream.

Automating rlogin

In some organizations, many different UNIX hosts are used every day and needing to type passwords all the time when using *rlogin* was deemed to be somewhat of a chore. On these systems, it is possible for administrators to set up control files that specify combinations of host names, user names and passwords. If set up correctly, this enables an authorized user to utilize *rlogin* to remotely access a host automatically, without having to enter either a login name or password, which can be a time savings.

rlogin Security Concerns and slogin

As originally designed, *rlogin* is a classic example of a protocol from the early days of TCP/IP: it emphasizes simplicity and usability over security. This is especially true of the automated login process just described. The original schemes used by *rlogin* for authentication are considered inadequate for modern TCP/IP internetworks, especially those connected to the Internet. Later versions of *rlogin* have been enhanced with more secure

authorization methods. There is also a newer program called *slogin* (for *secure login*) that uses stronger authentication and encryption, and is intended to replace *rlogin* on newer systems.



Key Concept: The Berkeley remote or “r” commands facilitate remote operations between UNIX hosts on a TCP/IP internetwork. The base command of the family is the *remote login* command, *rlogin*, which allows a device on one host to access and use another as if he or she were locally connected to it. *rlogin* is often used as an alternative to Telnet, but is simpler both conceptually and practically.

Berkeley Remote Shell (rsh)

The Berkeley [remote login command \(rlogin\)](#) allows a user to easily access a remote UNIX host over a TCP/IP internetwork. A user would normally use *rlogin* when he or she needs to log in to a server to perform a number of tasks. There are some situations, however, where a user needs to only enter one command on a remote host. With *rlogin*, the user would have to log in to the host, execute the command, and then log back out again.

This isn't exactly an earth-shattering amount of inconvenience, especially when the correct configuration files are set up to allow automatic login. Over the course of time, however, all the extra logging in and out can become tedious. As a convenience, a variation of *rlogin* was created called *remote shell (rsh)*, which allows a user to access a remote host and execute a single command upon it without requiring the login and logout steps.



Note: “Shell” is the standard term used in UNIX to refer to the user interface that accepts commands from the user and displays output on the screen.

***rsh* Operation**

The *rsh* command is based on *rlogin* and really works in much the same way, except that it is oriented around executing a command rather than establishing a persistent login session. The server process on the remote host is usually called *rshd* (*remote shell daemon*) and listens for incoming *rsh* requests. When one is received, the user is logged in through the same mechanism as *rlogin*. The command is then run on the remote host and the user is automatically logged out.

Automated Use of rsh by Programs

rsh is most useful when automatic login is employed, so that the program can be run without the need for the user to enter a login name or password. In that case, it is possible to have programs use *rsh* to automatically run commands on remote hosts without the need for human intervention, which opens up a number of possibilities for UNIX users. The

normal UNIX user interface concepts of *standard input (stdin)*, *standard output (stdout)* and *standard error (stderr)* also apply to *rsh*, so you can use it to execute a remote command and redirect the output to a local file. For example, this command would let a user get a listing of his or her home directory on the server “<somehost>” and store it in the local file “remotelist”:

```
rsh <somehost> ls -l >remotelist
```



Key Concept: The *remote shell* or *rsh* command is similar to the Berkeley *rlogin* command, but instead of opening a login session on a remote host, it executes a single, user-provided command. *rsh* can be helpful for users who need to perform a quick operation on a remote host, and can also be employed by other programs to automate network tasks.

rsh* Security Concerns and *ssh

Since *rsh* is based on *rlogin*, all of the concerns that apply to *rlogin* are also relevant here, especially with regard to security. (We no more want an unauthorized user running commands on our servers than logging in to them!) As with *rlogin*, newer versions of *rsh* support more advanced authentication options than the original software. Also, just as *slogin* is a newer, more secure version of *rlogin*, there is a program called *ssh* (*secure shell*) that replaces *rsh* on many systems.



Note: On some systems, if *rsh* is entered without a command specified to execute, then an interactive remote session is established, exactly as if the *rlogin* command had been entered instead of *rsh*.

Other Berkeley Remote ("r") Commands (*rcp*, *ruptime*, *rwho*)

The *rlogin* and *rsh* commands are the generic members of the Berkeley “r” family of programs that allow remote access to a host. To complement these, a small number of specific remote commands were also defined. These are essentially remote versions of some of the more common UNIX functions—instead of the command being applied to only one system, however, it is used between two systems or across all systems on a TCP/IP network.

All of these commands are based on *rlogin* the same way that *rsh* is. They work in the same way, but instead of opening up a session or passing a user-specified command to the remote host, they execute a particular function. The following are the most common of these remote commands and briefly, how each is used:

-
- **Remote Copy (*rcp*):** This is the remote version of the UNIX copy (*cp*) command; it allows a file to be copied between the local host and the remote host, or between two remote hosts. The usual syntax is basically the same as the regular *cp* command, but the source and/or destination is specified as being on a remote host.

The *rcp* command can be used in a manner similar to [FTP](#), but is much simpler and less capable. Or to put it another way: *rcp* is to FTP, what *rlogin* is to [Telnet](#). (That's not a perfect analogy, but it's pretty close.)

- **Remote Uptime (*ruptime*):** The UNIX command *uptime* is used to display how long a computer has been running since it was last booted, along with information related to its current load. *ruptime* is the remote version of this command; it displays the current status of each machine on the network (up or down), how long each up machine has been up since its last boot, and its load statistics.
- **Remote Who (*rwho*):** This is the remote version of the *who* command. Where *who* shows all the users logged on to the host where it is run, *rwho* shows all users logged on to all machines on the network.

The *ruptime* and *rwho* commands both rely on the presence of the *rwhod* (*remote who daemon*) running in the background on networked machines. These processes routinely share information with each other about host uptime and who is logged on to each system, so it can be quickly displayed when either *ruptime* or *rwho* is run.

On some operating systems, other remote commands may also be implemented. As with *rlogin* and *rsh*, security issues may apply to these commands, and there may be efficiency concerns with others (such as *rwho*). For these reasons, on many networks these commands are no longer used.



Internet Relay Chat Protocol (IRC)

The primary advantage that [electronic mail](#) offers over conventional mail is *speed*. Instead of having to wait for days or weeks for a message to be delivered, it usually arrives in minutes or even seconds. This makes electronic mail far more useful than the regular postal service for most types of information transfer. There are some cases, however, where speed of delivery is not sufficient to make electronic mail an ideal mechanism for communication. One such case is where a *dialog* is required between two parties.

Consider that even though electronic mail may be delivered very quickly, it uses a [decoupled model of communication](#). When person *A* sends an e-mail to person *B*, the message may show up in *B*'s inbox in a matter of seconds, but *B* may not in fact be around to read it at the time it arrives. *B* might not see the message until hours later; he would then send a response to *A*, who in turn might not see it for a while. If the subject they are discussing requires several dozen iterations of this sort, it could take a very long time before the exchange is completed.

In the real world, of course, most of us would never use mail for such a conversation, preferring instead that high-tech communication device that we call... the telephone. ☺ Many people using computers realized that it would be useful to have a way for two or more people to interactively discuss issues in a manner similar to a telephone conversation. In the online world, this is commonly called *chatting*, and one of the first and most important application protocols designed to implement it in TCP/IP was the *Internet Relay Chat Protocol (IRC)*.

IRC History and Standards

Prior to the widespread use of the Internet, people with computers would often communicate by dialing in to a *bulletin board system (BBS)* or other proprietary service. IRC was originally created by a gentleman from Finland named Jarkko Oikarinen, based on his experience with chat applications on BBSes. He wrote the first client and server software in 1988; the protocol was later formally defined in RFC 1459, [Internet Relay Chat Protocol](#), published May 1993. In April 2000, the IRC standard was revised and enhanced with several new extended capabilities, and published as a set of four smaller documents: RFCs 2810 through 2813. Each of these focuses on one particular area of IRC functionality.



Note: RFC 1459 has the [RFC status](#) “Experimental”, and the RFC 2810 to 2813 group is designated “Informational”. This makes IRC optional; it need not be implemented on TCP/IP devices.

IRC Communication Model and Client/Server Operation

IRC is an interesting protocol in that it is not based strictly on [the standard client/server model of TCP/IP protocol operation](#). *IRC servers* are TCP/IP machines that run IRC server software. They are configured with information that allows them to establish TCP connec-

tions to each other; **TCP** is used because the connections are maintained over a long period of time and reliable transport of data is required. Server connections are used to exchange control information and user data, forming a logical *IRC network* at the application level, which allows any server to send to any other using intermediate servers as conduits. Servers are managed by *IRC operators (IRCops)* who have special privileges that allow them to ensure that everything runs smoothly on the network.

The IRC network forms the backbone of the IRC communication service. A user can access the network by running *IRC client* software on any TCP/IP-enabled device. The user enters the name of one of the servers on the network and establishes a TCP connection to that server. This causes the user to be connected directly to one server, and thus, indirectly to all of the others on the network. This allows that user to send and receive messages to and from all other users connected either to the user's server or other servers.

Group Messaging and IRC Channels

The most common type of communication in IRC is *group messaging*, which is accomplished using *IRC channels*. A channel is a virtual meeting place of sorts, and is also sometimes called a *chat room* (though IRC purists scoff at the use of that term.) Every IRC network has hundreds or even thousands of different channels, each of which is dedicated to a particular type of discussion, ranging from the serious to the silly. For example, a group of people interested in talking about meteorology could establish a channel called “#weather” where they would meet regularly to discuss various aspects of climatology and interesting weather events.

IRC is an inherently text-based protocol (though it is also possible to use IRC clients to transfer arbitrary files between users, including images and executable programs.) To communicate in a channel, all a user needs to do is enter text in the appropriate spot on the IRC client program; this text is automatically sent to every other member of the channel. The IRC network handles the relaying of these messages in real time from one user, to that user's connected server, to other servers in the network, and then to all user machines on those servers. When other users see the first user's message they can reply with messages of their own, which will in turn be propagated across the network. Each IRC user chooses a nickname (often abbreviated nick) that is like a “handle” used for communication while connected to the network.

Individual Messaging

IRC also supports one-to-one communication, which can be used for private conversation. To use this method, all a user needs is the nickname of another user to whom he or she wants to talk; he or she uses a special command to send messages directly to that user, who can respond in kind. This is not a secure form of communication, since the messages are not encrypted, and they pass through servers where they could be monitored. However, there is so much traffic on a typical IRC network that any given message is unlikely to be monitored, so there is not much concern (unless you work for the CIA or just developed a cure for the common cold or something. ☺)

The IRC protocol defines a rich command set that allows users to perform essential functions, such as joining or leaving a channel, changing nicknames, changing servers, setting operating modes for channels and so forth. The exact command set and features available depends both on the specific software used for the user's IRC client, and the features available on the IRC network itself, not all of which run the same version of the protocol.

IRC became very popular in the early 1990s because of the powerful way that it allows users from anywhere on the Internet to meet and share information dynamically. Not only does it act like a text-based "telephone", it allows users across the globe to communicate without the expense of a long-distance call.

IRC and the Modern Internet

One of the most important characteristics of IRC is its open-ended nature: it gives every person the freedom to communicate in whatever way he or she considers best. For example, every IRC channel has an owner, who has certain rights related to how the channel is used, including the ability to decide who should be allowed in the channel and who not. This may seem autocratic, but IRC lets anyone start a new channel instantly and become that channel's owner, without the need for prior registration or authorization. This means that if you don't like how a particular channel is run, you can start your own with a minimum of fuss; you are not forced to adhere to anyone's rules, other than the rules set forth for the server (which are usually just intended to prevent abuse.)

This same principle extends to the IRC networks themselves as well—there isn't just one single IRC network, there are dozens of different ones. Some are large, well-established networks that may have over 100 servers and thousands of users, while others are smaller and devoted to specific areas of interest or geographical regions. Anyone can set up their own IRC network if they have the hardware and software, and some organizations have in fact set up private, dedicated IRC servers for their own use.

IRC is considered by many to be the most important "ancestor" of the related interactive applications collectively known as *instant messaging*. These services are offered by several organizations, including America Online (AOL), Yahoo! and Microsoft's MSN. The idea behind them is very similar to that of IRC; each allows a message sent by one user to be displayed immediately to another, though most are focused primarily on user-to-user messages rather than groups. Instant messaging has in fact surpassed IRC in overall use, perhaps due to the large subscriber base of services like AOL. However, IRC is still widely used by thousands of enthusiasts on a daily basis for both entertainment and business purposes.



TCP/IP Administration and Troubleshooting Utilities and Protocols

The first two large subsections of [the large section devoted to TCP/IP applications and application protocols](#) discussed file and message transfer applications, and interactive and remote access applications, respectively. These are the classical applications that are most often employed by the users of TCP/IP internetworks. Since they are the means by which users communicate, they can be considered in some ways the “raison d’être” of TCP/IP and the Internet itself.

In contrast, this third subsection is a bit different. It doesn’t describe applications designed for end-users. Rather, it discusses a set of *TCP/IP troubleshooting utilities and protocols*, which are normally the province of internetwork administrators. Even though millions of people use TCP/IP every day without even knowing that these applications exist—much less how they work—they are critically important to those who maintain TCP/IP internetworks. Since many of you are studying TCP/IP so that you can implement and administer this technology, understanding how these applications work is well worth your time.

In this section I provide an overview description of a number of software utilities that are commonly employed to help set up, configure and maintain TCP/IP internetworks. These programs allow a network administrator to perform functions such as checking the identity of a host; verifying connectivity between two hosts; checking the path of routers between devices; examining the configuration of a computer; looking up a DNS domain name; and much more.



Note: The goal of this section is to provide explanations of the general purpose and function of troubleshooting utilities, so you will know how they can help you manage TCP/IP networks. As part of these descriptions, I demonstrate the typical syntax used to invoke each utility in both UNIX and Windows. While I have tried to be quite complete in these depictions, they are intended only to give you a better idea of what these programs can do—this section should not be considered a reference manual for these utilities. Due to variations in software implementations, please consult your operating system documentation for the details on exactly how each program should be used on your own network. On Windows systems, try “<program> /?” to see the syntax of the program; on UNIX/Linux try “man <program>”.



Background Information: Many of the software tools described in this section are designed to manage the operation of other TCP/IP protocols, such as the [Internet Protocol](#), [Domain Name System](#) or [Dynamic Host Configuration Protocol](#). To fully appreciate how these utilities work, you need to understand the basics of these and other key TCP/IP protocols. In particular, a number of the utilities discussed here communicate use ICMP messages, so I would recommend familiarity with [ICMP](#) before proceeding.

TCP/IP Host Name Utility (hostname)

They say the best place to start is at the beginning. Therefore, in examining TCP/IP administration and troubleshooting utilities, why not begin with the basics? One of the most fundamental of tasks in diagnosing problems with a networked computer is identifying it. Just as the first thing we usually do when we meet someone is exchange names, one of the first actions an administrator takes when accessing a device is to determine its name, if it is not known. This is accomplished using the *hostname* utility.

You may recall from our [discussion of TCP/IP name systems](#) that there are two different ways that hosts can be named. The first way is to manually assign “flat” names to devices using [host tables](#) or equivalent means; this is most often used for devices that not going to be accessed on the public Internet. The second is to give a device a domain name within the [Domain Name System \(DNS\)](#). The *hostname* utility can be used for both types of named hosts, but it functions in a slightly different way for each.

On most systems, including Windows and many UNIX implementations, the *hostname* utility is very, very simple. When the command is entered by itself on a line with no arguments, it displays the full name of the host. If it is entered with the “-s” (“short”) parameter, then if the host name is a [fully qualified DNS domain name](#), only the local label of the node is shown and not the full domain name; if the host has a flat (non-DNS) name the parameter has no effect. A simple example is shown in [Table 284](#).

Table 284: Using the *hostname* Utility To Check A Host Name

```
% hostname
fearn.pair.com
% hostname -s
fearn
```

The *hostname* utility is also intended to allow an administrator to set the name of a host. The syntax for this is also simple; you just supply the name of the host as a parameter, as follows:

```
hostname <new_hostname>
```

However, in most implementations, the use of the *hostname* command for setting a device’s name is either disabled or restricted. In Windows systems, a special applet in the Control Panel is used to set the device’s name; attempting to set it using *hostname* will result in an error message. In UNIX, the super-user of the system can use *hostname* to set the device’s name, but it is more common for this to be done by other means, such as editing the configuration file */etc/hosts*. Obviously, if a simple flat name is being assigned to this host, the administrator has full control over it, while if DNS is used then the proper procedures for registering the name must be followed.

In most operating systems, the “-s” parameter is the only one that this command supports. The parameter is not supported on all implementations of the “hostname” command, however; on some of these, if you use “hostname -s”, the system may report its host name

as being “-s”. On certain Linux systems, a few additional parameters are included that allow different ways for the host name to be displayed, as well as some miscellaneous functions such as showing the version number of the program.



Note: One point worth mentioning is that the *hostname* utility is not, strictly speaking, tied into the operation of DNS or other formal mechanisms for identifying a host. It simply displays what the administrator has set it to show. Obviously it makes sense for this to be set to the host’s DNS name, but there may be exceptions.



Key Concept: The simplest and most basic of TCP/IP administrative utilities is *hostname*, which returns the name of the host upon which it is run.

TCP/IP Communication Verification Utility (ping/ping6)

One of the most common classes of problems that network administrators are often called upon to solve is an inability of two hosts to communicate. For example, a user on a corporate network might not be able to retrieve one of his files from a local server, or another user might be having difficulty loading her favorite Web site. In these and many similar situations, one important step in diagnosing the problem is to verify that basic communication is possible between the TCP/IP software stacks on the two machines. This is most often done using the *ping* utility, or *ping6* in IPv6 implementations.



Note: Some people say that “ping” is an acronym for “Packet Internet Groper”, while others insist that it is actually based on the use of the term to refer to a sonar pulse sent by a submarine to check for nearby objects. I really don’t know which of these is true, but I prefer the second explanation. Consider that the utility works in a way similar to a sonar “ping”, and that it was originally written by a gent named Mike Muuss, who worked at the US Army Ballistics Research Laboratory. The first explanation is weaker; it’s possible, but the phrase “Packet Internet Groper” isn’t really grammatical, and I don’t even want to *think* about what it is this utility is supposed to be “groping”! ☺

The *ping* diagnostic utility is one of the most commonly used, and is present in just about every TCP/IP implementation. It is usually implemented and accessed as a command-line utility, though there are also now graphical and menu-based versions of the program on some operating systems.

Operation of the ping Utility

The *ping* utility is implemented using ICMP *Echo (Request)* and *Echo Reply* messages. As explained in [the topic discussing these message types](#), they are designed specifically for these sorts of diagnostic purposes. When Device *A* sends an ICMP *Echo* message to device *B*, device *B* responds by sending an ICMP *Echo Reply* message back to device *A*. The same functionality exists in ICMPv6, the IPv6 version of ICMP; the [ICMPv6 Echo and Echo Reply messages](#) only differ from the IPv4 ones slightly in their field structure.

This would seem to indicate that *ping* would be an extremely simple utility that would send one *Echo* message and wait to see if an *Echo Reply* was received back; if so, then this would provide that the two devices were able to communicate, and if not, this would indicate a problem somewhere on the internetwork between the two. However, almost all *ping* implementations are much more complex than this. They use multiple sets of *Echo* and *Echo Reply* messages, along with considerable internal logic, to allow an administrator to determine all of the following, and more:

- ① Whether or not the two devices can communicate;
- ② Whether congestion or other problems exist that might allow communication to succeed sometimes but cause it to fail in others, seen as packet loss—if so, how bad the loss is;
- ③ How much time it takes to send a simple ICMP message between devices, which gives an indication of the overall latency between the hosts, and also indicates if there are certain types of problems.

Basic ping Use

The most basic use of the *ping* command is to enter it by itself with the IP address of a host. Virtually all implementations also allow a host name to be used, which will be [resolved to an IP address](#) automatically. When the utility is invoked with no additional options, default values are used for parameters such as what size message to send, how many messages to be sent, how long to wait for a reply, and so on. The utility will transmit a series of *Echo* messages to the host and report back whether or not a reply was received for each; if a reply is seen, it will also indicate how long it took for the response to be received. When the program is done, it will provide a statistical summary showing what percentage of the *Echo* messages received a reply, and the average amount of time for them to be received.

Table 285 shows an example using the *ping* command on a Windows XP computer (mine!), which by default sends four 32-byte *Echo* messages and allows four seconds before considering an *Echo* message lost. I use a satellite Internet connection that has fairly high latency and also occasionally drops packets. This isn't great for me, but it is useful for illustrating how *ping* works.

Table 285: Verifying Communication Using the *ping* Utility

```
D:\aa>ping www.pcguide.com
Pinging pcguide.com [209.68.14.80] with 32 bytes of data:

Reply from 209.68.14.80: bytes=32 time=582ms TTL=56
Reply from 209.68.14.80: bytes=32 time=601ms TTL=56
Request timed out.
Reply from 209.68.14.80: bytes=32 time=583ms TTL=56

Ping statistics for 209.68.14.80:
    Packets: Sent = 4, Received = 3, Lost = 1 (25% loss),
    Approximate round trip times in milli-seconds:
        Minimum = 582ms, Maximum = 601ms, Average = 588ms
```

Methods of Diagnosing Connectivity Problems Using *ping*

Most people find that using *ping* with default settings is enough for their needs. In fact, the utility can be used in this simplest form to perform a surprising number of diagnostic checks. In many cases, the *ping* command can be used to diagnose connectivity problems by using it multiple times in sequence, often starting with checks at or close to the transmitting device and then proceeding outwards towards the other device with which the communication problem has been observed. Some examples of how *ping* can be used in this way:

- ① **Internal Device TCP/IP Stack Operation:** By performing a *ping* on the device's own address, you can verify that its internal TCP/IP stack is working. This can also be done using the standard IP loopback address, 127.0.0.1.
- ② **Local Network Connectivity:** If the internal test succeeds, it's a good idea to do a *ping* on another device on the local network, to verify that local communication is possible.
- ③ **Local Router Operation:** If there is no problem on the local network, it makes sense to *ping* whatever local router the device is using to make sure it is operating and reachable.
- ④ **Domain Name Resolution Functionality:** If a *ping* performed on a DNS domain name fails, you should try it with the device's IP address instead. If that works, this implies either a problem with domain name configuration or resolution.
- ⑤ **Remote Host Operation:** If all the preceding checks succeed, you can try *pinging* a remote host to see if it responds. If it does not, you can try a different remote host; if that one works, it is possible that the problem is actually with the first remote device itself and not with your local device.



Note: While the inability to get a response from a device to a *ping* has traditionally been interpreted as a problem in communication, this is not always necessarily the case. In the current era of increased security consciousness, some networks are set up to not respond to *Echo* messages, to protect against attacks that use floods of such messages. In this case a *ping* will fail, even though the host may be quite reachable.



Key Concept: The TCP/IP *ping* utility is used to verify the ability of two devices on a TCP/IP internetwork to communicate. It operates by having one device send ICMP *Echo (Request)* messages to another, which responds with *Echo Reply* messages. The program can be helpful in diagnosing a number of connectivity issues, especially if it is used to test the ability to communicate with other devices in different locations. It also allows the average round-trip delay to exchange messages with another device to be estimated.

***ping* Options and Parameters**

All *ping* implementations include a number of options and parameters that allow an administrator to fine-tune how it works. They allow *ping* to be used for more extensive or specific types of testing. For example, *ping* can be set in a mode where it sends *Echo* messages continually, to check for an intermittent problem over a long period of time. You can also increase the size of the messages sent or the frequency with which they are transmitted, to test the ability of the local network to handle large amounts of traffic.

As always, the exact features of the *ping* program are implementation-dependent; even though UNIX and Windows systems often include many of the same options, they usually use completely different option codes. [Table 286](#) shows some of the more important options that are often defined for the utility on many UNIX systems, and where appropriate, the parameters supplied with the option. [Table 287](#) shows a comparable table for a typical Windows system.

Table 286: Common UNIX *ping* Utility Options and Parameters (Page 1 of 2)

Option / Parameters	Description
-c <count>	Specifies the number of <i>Echo</i> messages that should be sent.
-f	Flood mode; sends <i>Echo</i> packets at high speed to stress-test a network. This can cause serious problems if not used carefully!
-i <wait-interval>	Tells the utility how long to wait between transmissions.
-m <ttl-value>	Overrides the default Time To Live (TTL) value for outgoing <i>Echo</i> messages.
-n	Numeric output only; suppresses lookups of DNS host names to save time.

Table 286: Common UNIX *ping* Utility Options and Parameters (Page 2 of 2)

Option / Parameters	Description
-p <pattern>	Allows a byte pattern to be specified for inclusion in the transmitted <i>Echo</i> messages. This can be useful for diagnosing certain odd problems that may only occur with certain types of transmissions.
-q	Quiet output; only summary lines are displayed at the start and end of the program's execution, while the lines for each individual message are suppressed.
-R	Tells the utility to include the <i>Record Route IP option</i> , so the route taken by the ICMP <i>Echo</i> message can be displayed. This option is not supported by all implementations; the <i>traceroute utility</i> is usually a better idea.
-s <packet-size>	Specifies the size of outgoing message to use.
-S <src-addr>	On devices that have multiple IP interfaces (addresses), allows a ping sent from one interface to use an address from one of the others.
-t <timeout>	Specifies a timeout period, in seconds, after which the <i>ping</i> utility will terminate, regardless of how many requests or replies have been sent or received.

Table 287: Common Windows *ping* Utility Options and Parameters

Option / Parameters	Description
-a	If the target device is specified as an IP address, force the address to be resolved to a DNS host name and displayed.
-f	Sets the <i>Don't Fragment</i> bit in the outgoing datagram.
-i <ttl-value>	Specifies the <i>TTL value</i> to be used for outgoing <i>Echo</i> messages.
-j <host-list>	Sends the outgoing messages using the specified <i>loose source route</i> .
-k <host-list>	Sends the outgoing messages using the indicated <i>strict source route</i> .
-l <buffer-size>	Specifies the size of the data field in the transmitted <i>Echo</i> messages.
-n <count>	Tells the utility how many <i>Echo</i> messages to send.
-r <count>	Specifies the use of the <i>Record Route IP option</i> and the number of hops to be recorded. As with the corresponding UNIX "-R" option, the <i>traceroute utility</i> is usually preferable.
-s <count>	Specifies the use of the <i>IP Timestamp option</i> to record the arrival time of the <i>Echo</i> and <i>Echo Reply</i> messages.
-t	Sends <i>Echo</i> messages continuously until the program is interrupted.
-w <timeout>	Specifies how long the program should wait for each <i>Echo Reply</i> before giving up, in milliseconds (default is 4000, for 4 seconds).

The *ping6* Utility

The IPv6 version of *ping*, sometimes called *ping6*, works in very much the same way as IPv4 *ping*. The main differences between the two utilities are that *ping6*'s options and parameters reflect the [changes made in addressing and routing in IPv6](#).

TCP/IP Route Tracing Utility (tracert/traceroute6)

The *ping* utility described in [the preceding topic](#) is extremely helpful for checking whether or not two devices are able to talk to each other. However, it provides very little information regarding what is going on between those two devices. In the event that ping shows either a total inability to communicate or intermittent connectivity with high loss of transmitted data, we need to know more about what is happening to IP datagrams as they are carried across the internetwork. This is especially important when the two devices are far from each other, especially if we are trying to reach a server on the public Internet.

I described in my [overview of IP datagram delivery](#) that when two devices are not on the same network, data sent between them must be delivered from one network to the next until it reaches its destination. This means that any time data is sent from device *A* on one network to device *B* on another, it follows a *route*, which may not be the same for each transmission.

When communication problems arise, it is very useful to be able to check the specific route taken by data between two devices. A special route tracing utility is provided for this function, called *tracert* (abbreviated *tracert* in Windows systems, a legacy of the old eight-character limit for DOS program names). The IPv6 equivalent of this program is called *traceroute6*.

Operation of the traceroute Utility

Like the *ping* utility, *tracert* is implemented using [ICMP messages](#). However, unlike *ping*, *tracert* was originally not designed to use a special ICMP message type intended exclusively for route tracing. Instead, it makes clever use of the IP and ICMP features that are designed to prevent routing problems.

Recall that the [IP datagram format](#) includes a *Time To Live (TTL)* field. This field is set to the maximum number of times that a datagram may be forwarded before it must be discarded; it exists to prevent datagrams from circling an internetwork endlessly. If a datagram must be discarded due to expiration of the *TTL* field, the device that discards it is supposed to send back to the device that sent that datagram an ICMP *Time Exceeded* message. This is explained in much more detail in [the topic that describes that message](#).

Under normal circumstances, this only occurs when there is a problem, such as a router loop or other misconfiguration issue. What *tracert* does is to force each router in a route to report back to it by intentionally setting the *TTL* value in test datagrams to a value too low to allow them to reach their destination.

Suppose we have device *A* and device *B*, which are separated by routers *R1* and *R2*—three hops total. If you do a *tracert* from device *A* to device *B*, here's what happens:

1. The *tracert* utility sends a dummy UDP message (sometimes called a *probe*) to a port number that is intentionally selected to be invalid. The *TTL* field of the IP datagram is set to 1. When *R1* receives the message, it decrements the field, which will make its value 0. That router discards the probe and sends an ICMP *Time Exceeded* message back to device *A*.

-
2. Device A then sends a second UDP message with the *TTL* field set to 2. This time, *R1* reduces the *TTL* value to 1 and sends it to *R2*, which reduces the *TTL* field to 0 and sends a *Time Exceeded* message back to A.
 3. Device A sends a third UDP message, with the *TTL* field set to 3. This time, the message will pass through both routers and be received by device B. However, since the port number was invalid, the message is rejected by device B, which sends back a *Destination Unreachable* message to device A.

This process is illustrated in [Figure 321](#). Amusingly, we see that A sends out three messages to B, and gets back three error messages, and is happy about it! ☺ The route to device B is thus indicated by the identities of the devices sending back the error messages, in sequence. By keeping track of the time between when it sent each UDP message and received back the corresponding error message, the *traceroute* utility can also display how long it took to communicate with each device. In practice, usually three dummy messages are sent with each *TTL* value, so their transit times can be averaged by the user if desired.



Key Concept: The *traceroute* utility takes the idea behind *ping* one step further, allowing not only communication between two devices to be checked, but also letting an administrator see a list of all the intermediate devices between the pair. It works by having the initiating host send a series of test datagrams with *TTL* values that cause each to expire sequentially at each device on the route. The *traceroute* program also shows how much time it takes to communicate with each device between the sending host and a destination device.

Basic Use of the *traceroute* Utility

[Table 288](#) shows an example of a *traceroute* sent between two of the UNIX computers I use on a regular basis. I added the “-q2” parameter to change the default of three dummy messages per hop to two, so the output would fit better in its display table. In this case, the servers are separated by 14 hops. Notice how the elapsed time generally increases as the distance from the transmitting device increases, but it is not consistent because of random elements in the delay between any two devices (see the incongruously-large value in hop #10, for example). Also notice the asterisk (“*”) in the seventh hop, which means that no response was received before the timeout period for the second transmission with a *TTL* value of 7. Finally, there is no report at all for hop #13; this machine may have been configured not to send *Time Exceeded* messages.

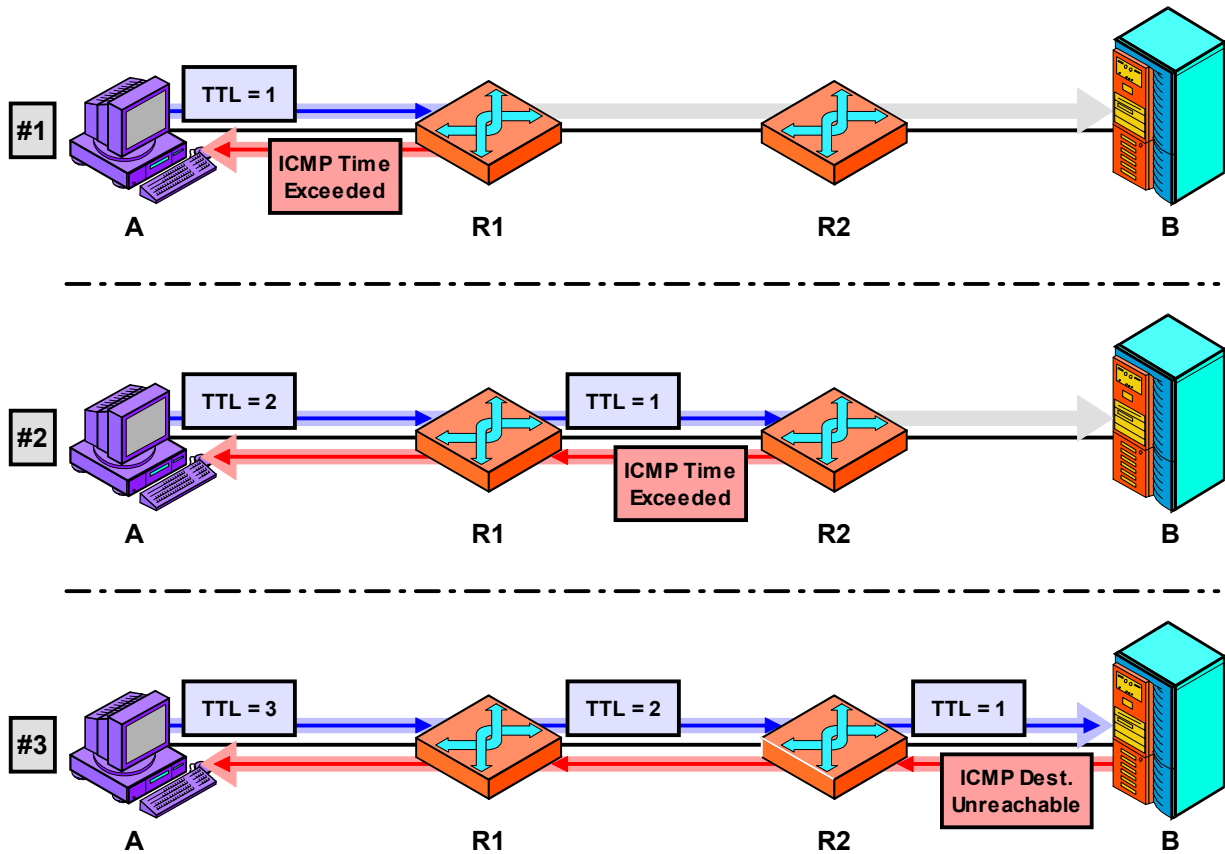

Figure 321: Operation of the traceroute/tracert Utility

The traceroute utility identifies the devices in a route by forcing them to report back failures to route datagrams with parameters intentionally set to invalid values. The first message sent by device A here has a *Time To Live (TTL)* value of 1, which will cause R1 to drop it and send an *ICMP Time Exceeded* message back to A. The second one has a *TTL* value of 2, so it will be dropped and reported by R2. The third will pass both routers and get to the destination host, B, but since the message is deliberately chosen with a bogus port number, this will cause an *ICMP Destination Unreachable* to be returned. These error messages identify the sequence of devices in the route between devices A and B.

Table 288: Route Tracing Using the *traceroute* Utility

```
traceroute -q2 www.pcguides.com
traceroute to www.pcguides.com (209.68.14.80), 40 hops max, 40 byte packets
 1 cisco0fe0-0-1.bf.sover.net (209.198.87.10)  1.223 ms  1.143 ms
 2 cisco1fe0.bf.sover.net (209.198.87.12)  1.265 ms  1.117 ms
 3 cisco0a5-0-102.wnsvtao.sover.net (216.114.153.170)  8.004 ms  7.270 ms
 4 207.136.212.234 (207.136.212.234)  7.163 ms  7.601 ms
 5 sl-gw18-nyc-2-0.sprintlink.net (144.232.228.145)  15.948 ms  20.931 ms
 6 sl-bb21-nyc-12-1.sprintlink.net (144.232.13.162)  21.578 ms  16.324 ms
 7 sl-bb27-pen-12-0.sprintlink.net (144.232.20.97)  18.296 ms  *
 8 sl-bb24-pen-15-0.sprintlink.net (144.232.16.81)  18.041 ms  18.338 ms
 9 sl-bb26-rly-0-0.sprintlink.net (144.232.20.111)  20.259 ms  21.648 ms
10 sl-bb20-rly-12-0.sprintlink.net (144.232.7.249)  132.302 ms  37.825 ms
11 sl-gw9-rly-8-0.sprintlink.net (144.232.14.22)  23.085 ms  20.082 ms
12 sl-exped4-1-0.sprintlink.net (144.232.248.126)  43.374 ms  42.274 ms
13 * *
14 pcguides.com (209.68.14.80)  41.310 ms  49.455 ms
```

Additional “unusual” results may be displayed under certain circumstances. For example, the traceroute program may display a code such as “!H”, “!N” or “!P” to indicate receipt of an unexpected *Destination Unreachable* message for a host, network, or protocol, respectively. Other error messages may also exist, depending on the implementation.



Note: Not all *traceroute* utility implementations use the technique described above. Microsoft’s *tracert* works not by sending UDP packets but rather ICMP *Echo* messages with increasing TTL values. It knows it has reached the final host when it gets back an *Echo Reply* message. A [special ICMP Traceroute message](#) was also developed in 1993, which was intended to improve the efficiency of *traceroute* by eliminating the need to send many UDP messages for each route tracing. Despite its technical advantages, since it was introduced long after TCP/IP was widely deployed, it never became a formal Internet standard and is not seen as often as the traditional method.

***traceroute* Options and Parameters**

As is the case with *ping*, *traceroute* can be used with an IP address or host name. If no parameters are supplied, default values will be used for key parameters; on the system I used, the defaults are three “probes” for each *TTL* value, a maximum of 64 hops tested, and packets 40 bytes in size. However, a number of options and parameters are also supported

to give an administrator more control over how the utility functions (such as the “-q” parameter I used in [Table 288](#)). Some of the typical ones in UNIX systems are described in [Table 289](#), while a smaller number of options exist in Windows, shown in [Table 290](#).

Table 289: Common UNIX *traceroute* Utility Options and Parameters

Option / Parameters	Description
-g <host-list>	Specifies a source route to be used for the trace.
-M <initial-ttl-value>	Overrides the default value of 1 for the initial <i>TTL</i> value of the first outgoing probe message.
-m <max-ttl-value>	Sets the maximum <i>TTL</i> value to be used; this limits how long a route the utility will attempt to trace.
-n	Displays the route using numeric addresses only, rather than showing both IP addresses and host names. This speeds up the display by saving the utility from having to perform reverse DNS lookups on all the devices in the route (ICMP messages use IP addresses, not domain names.)
-p <port-number>	Specifies the port number to be used as the destination of the probe messages.
-q <queries>	Tells the utility how many probes to send to each device in the route (default is 3).
-r	Tells the program to bypass the normal routing tables and send directly to a host on an attached network.
-s <src-addr>	On devices that have multiple IP interfaces (addresses), allows the device to use an address from one interface on a traceroute using another interface.
-S	Instructs the program to display a summary of how many probes did not receive a reply.
-v	Sets verbose output mode, which informs the user of all ICMP messages received during the trace.
-w <wait-time>	Specifies how long the utility should wait for a reply to each probe, in seconds (typical default is 3 to 5).

Table 290: Common Windows *tracert* Utility Options and Parameters

Option / Parameters	Description
-d	Displays the route using numeric addresses only rather than showing both IP addresses and host names, for faster display. This is the same as the “-n” option on UNIX systems.
-h <maximum-hops>	Specifies the maximum number of hops to use for tracing; default is 30.
-j <host-list>	Sends the outgoing probes using the specified loose source route.
-w <wait-time>	Specifies how long to wait for a reply to each probe, in milliseconds (default is 4000, for 4 seconds).

The traceroute6 Utility

The *traceroute6* utility is the IPv6 version of *traceroute* and functions in a very similar manner to its IPv4 predecessor. It obviously uses [IPv6 datagrams](#) instead of IPv4 ones, and responses from traced devices are in the form of [ICMPv6 Time Exceeded](#) and [Destination Unreachable](#) messages rather than their ICMPv4 counterparts.

TCP/IP Address Resolution Protocol Utility (arp)

TCP/IP allows us to create very large internetworks by connecting individual networks together. When we send data between devices on different networks, the data is routed between networks using the [Internet Protocol](#). This permits us to view even a huge internetwork such as the global Internet as if it were just a single large network. All devices on the internetwork are considered to be virtually connected at [layer three](#), since the process of routing lets any device talk to any other one.

However, there is no way for devices on distant networks to communicate directly. The internetwork communication at layer three really consists of a number of steps, called *hops*, that carry the data from its source to destination. Each hop in a route requires that data be sent between a pair of hardware devices, and each transmission must use layer two hardware addresses. Since TCP/IP uses layer three addresses, this means each hop requires that we translate the IP address of the target of the hop to a hardware address. This is called *address resolution*; the reasons why it is needed and the methods used for it are explained in detail in [the section on address resolution concepts](#).

In TCP/IP, address resolution functions are performed by the aptly-named [Address Resolution Protocol \(ARP\)](#). When a device needs to transmit to a device with a particular IP address, it can use [ARP's request/reply messaging protocol](#) to find out which hardware device corresponds to that IP address. However, each such message exchange takes time and network bandwidth, so for efficiency, every device maintains an [ARP cache](#), which is a table containing mappings between IP and hardware addresses. The ARP cache table can contain a combination of static cache entries that are manually inserted for frequently-accessed devices, and dynamic entries, which are entered automatically when a request/reply resolution is done, so the next time it is necessary to send to that device, the lookup process can be avoided.

arp Utility Functions

To allow administrators to manage this ARP cache table, TCP/IP devices include an *arp* utility. It has three basic functions, which are invoked using three different versions of the command (which, for once, are the same in UNIX and Windows!):

- ☉ **ARP Cache Table Display (“arp -a”)**: When the “-a” option is used with the utility, it displays the current contents of the ARP cache table. Each entry in the table shows the IP address and hardware address pair for one device (interface, actually); usually an indication is also given as to whether each entry is static or dynamic

The exact format of the display varies from one implementation to the next; some programs show IP addresses while others show host names, and still others may show both. Some systems default to displaying host names but allow the “-n” option to also be used to force only IP addresses to be displayed and not names.

- ☉ **ARP Cache Table Entry Addition (“arp -s <host-name> <hw-addr>”):** This syntax allows an administrator to make a new manual ARP cache table entry that maps the given host name to the specified hardware address.
- ☉ **ARP Cache Table Entry Deletion (“arp -d <host-name>”):** This command removes the specified cache entry from the table. Some implementations allow the addition of another parameter to specify that all entries should be removed from the cache.

Additional arp Features

Certain versions of the software may also supplement these basic commands with additional features. One common additional option on UNIX systems is the ability to specify a file from which cache table entries may be read, using “arp -f <file-name>”. This saves a considerable amount of time and effort compared to typing each entry manually using “arp -s”.

Note also that access to options that cause the ARP cache table to be changed may be restricted by the operating system to only authorized users. This is especially true of the delete function, and especially especially true of the function that allows the entire ARP table to be deleted. ☺



Key Concept: The TCP/IP *arp* utility is used by an administrator to inspect or modify a host’s ARP cache table, which contains mappings between TCP/IP host names and IP addresses.

TCP/IP DNS Name Resolution and Information Lookup Utilities **(nslookup, host and dig)**

The [Domain Name System \(DNS\)](#) is a critically important part of TCP/IP internetworks, especially the modern Internet, because it allows hosts to be accessed using easily-remembered names rather than confusing numerical addresses. Two different primary types of devices are involved in the operation of DNS: [DNS name servers](#) that store information about domains, and [DNS resolvers](#) that query DNS servers to transform names into addresses, as well as performing other necessary functions.

DNS resolvers are employed by Internet users on a continual basis to translate DNS names into address, but under normal circumstances, they are always invoked indirectly. Each time a user types a DNS name into a program such as a [World Wide Web](#) browser or [FTP](#) client—or even uses it in one of the other utilities in this section, such as [ping](#) or [traceroute](#)—the resolver automatically performs the name resolution without the user having to ask. For this reason, there is no need for users to manually resolve DNS names into addresses.

However, administrators often **do** need to perform a DNS resolution manually. For example, when troubleshooting a problem, the administrator may know a host's name but not its address; in the case of a security problem, the address may show up in a log file but the host name may not be known. In addition, even though users do not need to know the specifics of the [resource records](#) that define a DNS domain, administrators often need to be able to check these details, to make sure a domain is set up properly. Finally, admins also need some way to be able to diagnose problems with DNS servers themselves.

The nslookup Utility

To support all of these needs, modern TCP/IP implementations come equipped with one or more DNS name resolution and information lookup utilities. One of the most common DNS diagnostic utilities is *nslookup* (“name server lookup”), which has been around for many years. The details of how the program is implemented of course depend on the operating system, though most of them are quite similar in operation and settings. The utility can normally be used in two modes: interactive or non-interactive.

Non-Interactive Use of *nslookup*

The non-interactive version of *nslookup* is the simplest, and is most often used when an administrator wants to just quickly translate a name into an address or vice-versa. It is run by issuing the *nslookup* command using the following simple syntax:

```
nslookup <host> [<server>]
```

Here, “<host>” can be a DNS domain name, in which case a [normal resolution](#) will be performed, or it may be an IP address, which will cause *nslookup* to do a [reverse resolution](#) to return the associated DNS domain name. The “<server>” parameter is optional; if omitted, the program uses the default name server of the host where the command was issued. [Table 291](#) shows a simple example of non-interactive use of *nslookup*.

Table 291: DNS Name Resolution Using the *nslookup* Utility

```
D:\aa>nslookup www.pcguid.com
Server: ns1-mar.starband.com
Address: 148.78.249.200

Non-authoritative answer:
Name: pcguide.com
Address: 209.68.14.80
Aliases: www.pcguid.com
```

This example was done on my home PC that uses the Starband satellite Internet service; it is configured to use Starband's name server (“ns1-mar.starband.com”). The answer provided here is labelled “non-authoritative” because it came not from one of the DNS name servers that is a [DNS authority](#) for www.pcguid.com, but rather the Starband name server's [DNS cache](#).



Note: It is also possible to specify one or more options to modify the behavior of the lookup in non-interactive mode. These options are the same as the parameters controlled by the `nslookup set` command described in [Table 292](#); they are specified by preceding them with a dash. For example, “`nslookup -timeout=10 www.pcguides.com`” would perform the same lookup as in [Table 291](#) but with the timeout interval set to 10 seconds.

Interactive Use of *nslookup*

The interactive mode of *nslookup* is selected by simply issuing the name of the command with no parameters. This will cause the program to display the current default name server’s DNS name and address, and then provide a prompt at which the administrator may enter commands. Interactive mode allows someone to perform multiple lookups easily without having to type “`nslookup`” each time. More importantly, it provides more convenient control over the types of information that can be requested and how the lookups are performed.

The exact command set available in an *nslookup* implementation can usually be determined by issuing the command “`help`” or “`?`” at the *nslookup* prompt. [Table 292](#) shows some of the commands that are usually found in most *nslookup* implementations.

Table 292: Typical *nslookup* Utility Commands (Page 1 of 2)

Command and Parameters	Description
<code><host> [<server>]</code>	Look up the specified host, optionally using the specified DNS name server. Note that there is no actual command here, you just enter the name directly at the command prompt.
<code>server <server></code>	Change the default server to <code><server></code> , using information obtained from the current default server.
<code>!server <server></code>	Change the default server to <code><server></code> , using information obtained from the initial name server—that is, the system’s default server that was in place when the <code>nslookup</code> command was started (prior to any preceding changes of the current name server in this session).
<code>root</code>	Changes the default name server to one of the DNS root name servers .
<code>ls [-t <type>] <name></code>	Requests a list of information available for the specified domain name, by conducting a zone transfer . By default, the host names and addresses associated with the domain are listed; the “-t” option may be used to restrict the output to a particular record type. Other options may also be defined. Most servers restrict the use of zone transfers to designated slave servers, so this command may not work for ordinary clients.
<code>help</code>	Displays help information (usually a list of valid commands and options).
<code>?</code>	Same as “ <code>help</code> ” (only on some systems).
<code>set all</code>	Displays the current value of all <i>nslookup</i> options

Table 292: Typical *nslookup* Utility Commands (Page 2 of 2)

Command and Parameters	Description
<code>set <option>[=<value>]</code>	Sets an option to control the behavior of the utility. Most implementations include quite a number of options, some of which are controlled by just specifying a keyword, while others require a value for the option. For example, “set recurse” tells the program to use recursive resolution , while “set norecurse” turns it off; “set retry=3” sets the number of retries to 3.
<code>exit</code>	Quits the program.

Problems With *nslookup*

The *nslookup* utility is widely deployed on both UNIX and Windows systems, but the program is not without its critics. The complaints about it mainly center around its use of non-standard methods of obtaining information, rather than standard resolution routines. I have also read reports that it can produce spurious results in some cases. One example of a significant problem with the command is that it will abort if it is unable to perform reverse lookup of its own IP address. This can cause confusion, because users mistake that error for an error trying to find the name they were looking up.

For this and other reasons, a number of people in UNIX circles consider *nslookup* to be a “hack” of sorts, and for this reason, in some newer UNIXes *nslookup* has been *deprecated*. This simply means that it is still included in the operating system for compatibility, but it is not recommended and may be removed in the future. Instead, a pair of newer utilities are provided: *host* and *dig*.

The *host* Utility

The first alternative to *nslookup*, *host*, is most often used for simple queries such as would normally be performed using *nslookup*'s non-interactive mode. It is invoked in the same way as non-interactive *nslookup*:

```
host <host> [<server>]
```

The output is also similar to that of non-interactive *nslookup*, but less verbose. An example is shown in [Table 293](#).

Table 293: DNS Name Resolution Using the *host* Utility

```
%host www.pcguides.com
www.pcguides.com is an alias for pcguides.com.
pcguides.com has address 209.68.14.80
```

Even though *host* does not operate interactively, it includes a number of options that can allow an administrator to get the same information that would have been obtained using *nslookup*'s interactive mode. Some of the more common options are shown in [Table 294](#).

Table 294: Typical *host* Utility Options and Parameters

Option / Parameters	Description
-d	Turn on debug mode.
-l	Provides a complete list of information for a domain; this is similar to the “ls” command in interactive <i>nslookup</i> . This may be used with the “-t” option to select only a particular type of resource record for the domain.
-r	Disable recursion in the request. When this is specified, only the server directly queried will return any information; it will not query other servers.
-t <querytype>	Specifies a query for a particular resource record type, allowing any type of DNS information to be retrieved.
-v	Use verbose mode for output (additional details are provided).
-w	Wait as long as necessary for a response (no timeout).

The dig Utility

The second alternate to *nslookup* is *dig*, which stands for “Domain Information Groper” (likely a play on the supposed origin of the name “ping”). It differs from the *host* command in that it provides considerably more information about a domain, even when invoked in the simplest of ways. It is also quite a bit more complicated, with a large number of options, and features such as a batch mode for obtaining information about many domains.

The basic syntax for the *dig* command is different from *nslookup* or *host*, because if a non-default name server is specified, it is prepended with an at sign (“@”) and comes before the host to be looked up. A specific type of resource record can also be specified, like this:

```
dig [@<server>] <host> [<type>]
```

Table 295 shows the output from running *dig* on the same domain (www.pcguide.com) that I used as an example for *nslookup* and *host*. You can see that it provides much more information about the domain.

Table 295: DNS Name Resolution Using the *dig* Utility

```
%dig www.pcguide.com
; <<>> DiG 9.2.1 <<>> www.pcguide.com
;; global options: printcmd
;; Got answer:
;; ->>HEADER<<- opcode: QUERY, status: NOERROR, id: 15912
;; flags: qr rd ra; QUERY: 1, ANSWER: 2, AUTHORITY: 2,
ADDITIONAL: 0

;; QUESTION SECTION:
;www.pcguide.com.                IN      A

;; ANSWER SECTION:
www.pcguide.com.                 3600   IN      CNAME   pcguide.com.
pcguide.com.                    3600   IN      A       209.68.14.80

;; AUTHORITY SECTION:
pcguide.com.                    3600   IN      NS      ns0.ns0.com.
pcguide.com.                    3600   IN      NS      ns23.pair.com.

;; Query time: 1840 msec
;; SERVER: 209.68.1.87#53(209.68.1.87)
;; WHEN: Tue Nov 18 16:05:08 2003
;; MSG SIZE rcvd: 109Server: ns1-mar.starband.com
```

The *dig* command also allows specific types of resource records to be looked up, and includes dozens of options and settings. Since this topic is already getting very long and *dig* is by far the most advanced of the three utilities, I will stop here; consult your system's documentation for the full instructions on how *dig* works and a list of its parameters.



Key Concept: Most TCP/IP implementations provide one or more utilities that can be employed by an administrator to manually resolve DNS domain names to IP addresses or perform related searches for DNS information. One of the most common is *nslookup*, which allows a host name to be translated to an address or vice-versa; it has both interactive and non-interactive modes. On some operating systems, *nslookup* has been replaced by the *host* utility for simple DNS lookups, and the *dig* program for more detailed inspections of DNS resource information.



On The Web: The *dig* utility is very useful, but has still not been implemented on some systems. Fortunately, there is an online dig utility you can access using your browser on the Internet. Find it at <http://www.gont.com.ar/tools/dig>.

TCP/IP DNS Registry Database Lookup Utility (whois/nicname)

Utilities such as *nslookup* and *host* allow an administrator to resolve a DNS domain name to an address and also view detailed information about a domain's resource records. There are cases, however, where we need to know not the technical information about a domain but rather its [DNS registration](#) information. This includes details such as what organization owns the domain, when its registration expires, and who are the [designated contacts](#) who manage it.

In the early days of DNS, all domain names were centrally registered by a single authority, called the *Internet Network Information Center* (*InterNIC* or just the *NIC*). To allow Internet users to look up information about domains and contacts, a special server at this center was set up. A protocol was created to allow users to retrieve information from this server, called both *nicname* and *whois*. It was initially described in RFC 812 (1982) and then later, RFC 943 (1985). Over time, the name "whois" has become the preferred of the two, and is the one used today for the utility program that allows an administrator to look up DNS registration data. (It can also be used to look up information about IP addresses, but is used for this purpose much less commonly.)

As the Internet grew and expanded, it of course moved away from having a single centralized authority. The modern Internet has a [hierarchical structure of authorities](#) that are responsible for registering domain names in different portions of the [DNS name space](#). In recent years, this has been further complicated by the deregulation process that allows multiple registries for the generic top-level domains such as .COM, .NET and .ORG. All of this means that more work is needed to look up domain registration information, since it is distributed across many databases on different servers.

Syntax and Use of the whois Utility

To make it easier for administrators to find information about domains in this large distributed database, modern TCP/IP implementations generally come with an intelligent version of the *whois* utility. It is able to accept as input the name of a domain and automatically locate the appropriate registry in which that domain's information is located. The utility is usually used as follows:

```
whois [-h <whois-host>] <domain>
```

In this syntax, "<domain>" represents the name about which registration information is requested. The administrator can use the "-h" parameter to force the program to query a particular *whois* server, but again, this is usually not required. Some implementations also include other options that can be used to direct queries to particular registries.

Sample whois Output

Table 296 shows the sample output of the *whois* command on a FreeBSD UNIX machine (I have stripped out some of the preliminary general information and legal disclaimers to keep the table down to size).

Table 296: DNS Domain Registry Lookup Using the *whois* Program

```
%whois pcguide.com
Registrant:
  The PC Guide
  2080 Harwood Hill Road
  Bennington, VT 05201
  US

  ixl@fearn.pair.com
  +1.8025555555

Domain Name: PCGUIDE.COM

Administrative & Technical Contact:
  Charles Kozierok
  The PC Guide
  2080 Harwood Hill Road
  Bennington, VT 05201
  US

  ixl@fearn.pair.com
  +1.8025555555

Domain Name Servers:
  NS23.PAIR.COM
  NS0.NS0.COM

  Created:      August 25, 1997
  Modified:    July  7, 2003
  Expires:     August 24, 2008

** Register Now at http://www.pairNIC.com/ **
```

In this case, the registrar of the domain “pcguide.com” is *pairNIC*, the DNS registry division of *pair Networks*, the company I have used for Web hosting for many years (since 1997, as you can see). This output is public information, and lets anyone who has an interest in pcguide.com, for whatever reason, determine that I own the domain and learn how to contact me. (That is obviously not my real phone number, of course.) It also tells them that pair Networks runs the name servers that contain domain information for my domain.

Third-Party whois Tools

Many operating systems, including Windows, do not come with a *whois* command implementation, but there are third-party programs that will support the function. In recent years many different organizations have also set up Web sites that implement the *whois* function, which is much more convenient and user-friendly to those more accustomed to graphical operating systems like Windows. Many of these sites are provided as free services by DNS registrars, so customers can check if a name they are interested in is already taken, and if so, by whom.

One drawback of some of these systems is that they usually do not have the intelligence to check all the different registries where domain name records are stored. In most cases, a *whois* service provided by a registrar will only search for names in the particular [top-level domains \(TLDs\)](#) in which the registrar operates. So, if the registrar deals with .COM, .ORG and .NET, it may only support *whois* queries for those TLDs. To check the registration information for domains in more obscure TLDs, such as some of the less common [geopolitical \(country code\) domains](#), a considerable amount of searching may be required.



Key Concept: The TCP/IP *whois* utility allows registration information to be displayed for a DNS domain, such as its owner, contact information and the date that its registration expires. The program is most commonly found on UNIX operating systems, where it is given intelligence that allows it to automatically query the correct servers to find the information for most domains. Newer Web-based *whois* utilities also now exist, but are usually limited to displaying information about domains in only a specific subset of top-level domains.

TCP/IP Network Status Utility (*netstat*)

TCP/IP is a very complex protocol suite, as I am sure you would agree after perusing the contents of this Guide. It is actually quite amazing that most of the time, all of the different protocols, services and programs perform their jobs both efficiently and silently. Most of us don't even realize just how much is going on in the background, and that's as it should be. ☺ On the other hand, when a problem does occur on a TCP/IP network, the administrator charged with fixing it needs to obtain as much information as possible about what all those bits and pieces of the suite are doing behind the scenes. The network status utility, *netstat*, is provided for this purpose.

The *netstat* program is very simple in concept, being designed for only one purpose: to show information about the operation of TCP/IP on a device. The aforementioned complexity of TCP/IP, however, leads to *netstat* being rather elaborate itself: the program can provide a large variety of information. As usual, the options and output of *netstat* depend on the particular operating system type and version. It is somewhat different on UNIX and Windows machines, so I will describe each platform separately.

UNIX netstat

On most UNIX systems the *netstat* utility is very full-featured, with a typical implementation including dozens of options that can be used to control what information is displayed. These options may not all be used simultaneously; rather, they are arranged into *option groups*, each of which presents one class of information. Within each group, one option is mandatory; it identifies the group, and hence, the general kind of information that will be displayed. Other options are also possible in each group, which are optional and modify the command to provide better control on exactly what is output. In essence, then, *netstat* is really like many related utilities rolled into one.

UNIX netstat Option Groups, Options and Parameters

Table 297 provides a simplified summary of the option groups for a typical UNIX *netstat* implementation, in this case FreeBSD.

Table 297: Typical UNIX *netstat* Option Groups, Options and Parameters (Page 1 of 2)

Option Group, Options and Parameters	Description
netstat [-AaLSW] [-f <family>] [-p <protocol>] [-n]	This is the default invocation of <i>netstat</i> , with no mandatory options. It prompts the utility to display a list of active sockets on the host machine. The other options shown can be used to control what precisely is output; for example, “-a” causes server processes also to be shown.
netstat -i [-abdt] [-f <family>] [-n] netstat -I <interface> [-abdt] [-f <family>] [-n]	Tells <i>netstat</i> to provide information about all network interfaces (“-i”) or a particular network interface (“-I <interface>”). The “-a” option causes multicast addresses to be shown as well, “-b” displays bytes of data in and out on the interface, “-d” shows the number of dropped packets, and “-t” displays the value of watchdog timers.
netstat -w <interval> -d [-I <interface>]	Displays packet traffic information on all interfaces every “<interval>” seconds, or just on the specified interface if “-I <interface>” is included. If “-d” is included, also indicates the number of dropped packets.
netstat -s [-s] [-z] [-f <family>] [-p <protocol>]	Shows system-wide statistics for each of the protocols on the system (which may be modified to show information for only a particular address family or protocol). If the “-s” option is repeated, counters that have a value of zero are suppressed; the “-z” option resets the statistics after they are displayed.
netstat -i -s [-f <family>] [-p <protocol>] netstat -I <interface> -s [-f <family>] [-p <protocol>]	Displays statistics as for “netstat -s” just above, but on a per-interface basis rather than aggregated for the whole system.
netstat -m	Outputs memory management routine statistics.
netstat -r [-Aa] [-f <family>] [-n] [-W]	Displays the contents of the host’s routing tables . The options “-A” and “-a” provide additional information about the routes.
netstat -rs [-s]	Displays routing statistics; “-s” suppresses counters with a zero value.

Table 297: Typical UNIX *netstat* Option Groups, Options and Parameters (Page 2 of 2)

Option Group, Options and Parameters	Description
<code>netstat -g [-W] [-f <family>]</code>	Shows multicast routing information.
<code>netstat -gs [-s] [-f <family>]</code>	Shows multicast routing statistics; “-s” suppresses counters with a zero value.

UNIX *netstat* Universal Options and Parameters

Most of the options shown in these option groups are particular to those groups; for example, you cannot use “-s” when issuing the command “netstat -i”. However, there are also a number of *universal* options that can be used with more than one of these groups to modify the behavior of *netstat* variations in a consistent way. These options are described in [Table 298](#).

Table 298: Typical UNIX *netstat* Universal Options and Parameters

Option / Parameters	Description
<code>-f <family></code>	Limits the output of the command to information on a particular protocol address family, for hosts running multiple protocol suites. For example, the address family for regular TCP/IP is “inet”, while for IPv6 it is “inet6”. Others may also be supported.
<code>-p <protocol></code>	Restricts output to data related only to a particular protocol, such as IP, TCP, UDP, or ICMP.
<code>-n</code>	Shows network addresses in numeric form, instead of showing them as symbolic names. Also shows ports as numbers instead of converting well-known UDP and TCP port numbers to the protocol names that use them (for example, “23” rather than “telnet”).
<code>-W</code>	Suppresses the automatic truncation of addresses (which is sometimes done for display formatting).

Sample UNIX *netstat* Output

The *netstat* command can produce a startling amount of output, especially if you do not restrict it with some of the options in [Table 298](#). This is particularly true for *netstat* by itself and with the “-s” option. In [Table 299](#) I have shown sample output from running “plain” *netstat*, but I have truncated the list of connections so it would not be too long (I also reformatted the table so it would display better). Notice the last column, which shows the current state of the TCP connection (see, that [TCP finite state machine](#) stuff was useful after all! ☺)

Table 300 shows an example of the output of “netstat -s”; here I have shortened the size of the output by using “-p ip” to tell the program to only show me the statistics for the Internet Protocol.

Table 299: Sample Connections List From UNIX *netstat* Utility

```
%netstat
Active Internet connections
Prot Rcv Snd Local Address      Foreign Address    (state)
tcp4  0   0 pcguide.com.http  c-24-118-141-124.3384 ESTABLISHED
tcp4  0 827 pcguide.com.http  webcacheB03a.cac.46075 ESTABLISHED
tcp4  0   0 qs36.smtp         MV1-24.171.17.64.1339 ESTABLISHED
tcp4  0   0 pcguide.com.http  1Cust234.tnt1.le.1338 ESTABLISHED
tcp4  0   0 pcguide.com.http  1Cust234.tnt1.le.1337 FIN_WAIT_1
tcp4  0  84 pcguide.com.http  dial81-131-97-70.2902 FIN_WAIT_1
tcp4  0   0 pcguide.com.http  216.76.14.221.9954    FIN_WAIT_2
tcp4  0   0 pcguide.com.http  216.76.14.221.9945    FIN_WAIT_2
tcp4  0   0 pcguide.com.http  1Cust234.tnt1.le.1326 TIME_WAIT
```

Table 300: Sample IP Statistics From UNIX *netstat* Utility

```
%netstat -s -p ip
ip:
    57156204 total packets received
    0 bad header checksums
    4 with size smaller than minimum
    0 with data size < data length
    0 with ip length > max ip packet size
    0 with header length < data size
    0 with data length < header length
    0 with bad options
    0 with incorrect version number
    138 fragments received
    6 fragments dropped (dup or out of space)
    128 fragments dropped after timeout
    2 packets reassembled ok
    57085912 packets for this host
    24736 packets for unknown/unsupported protocol
    0 packets forwarded (0 packets fast forwarded)
    44957 packets not forwardable
    4 packets received for unknown multicast group
    0 redirects sent
    66183465 packets sent from this host
    177 packets sent with fabricated ip header
    0 output packets dropped due to no bufs, etc.
    0 output packets discarded due to no route
    0 output datagrams fragmented
    0 fragments created
    0 datagrams that can't be fragmented
    0 tunneling packets that can't find gif
    22 datagrams with bad address in header
```

Windows *netstat*

The Windows *netstat* utility is quite a bit simpler than the UNIX one, because it has a lot fewer options. This is good for those of us learning about the program, but not so wonderful for those who want maximum power and flexibility in using it.

Windows *netstat* Option Groups, Options and Parameters

Like the UNIX *netstat*, the Windows one has a set of options groups that dictate the general type of information shown, and a few universal options that can be used with multiple groups. The option groups and generic options are shown in [Table 301](#) and [Table 302](#).

Table 301: Typical Windows *netstat* Option Groups, Options and Parameters

Option Group, Options and Parameters	Description
<i>netstat [-n] [-o] [<interval>]</i>	When called with no mandatory options, <i>netstat</i> displays information about active TCP connections.
<i>netstat -a [-n] [-o] [-p <protocol> [<interval>]</i>	Displays all active TCP connections, as well as both TCP and UDP ports to which the host is listening.
<i>netstat -e [<interval>]</i>	Shows statistics for Ethernet interfaces.
<i>netstat -r [<interval>]</i>	Displays the current routing table for the device.
<i>netstat -s [-p <protocol> [<interval>]</i>	Displays TCP/IP statistics for the system by protocol.

Table 302: Typical Windows *netstat* Universal Options and Parameters

Option / Parameters	Description
<i>-n</i>	Displays network addresses in numeric form instead of symbolic name form. Also shows ports in numeric form instead of displaying standard process names associated with well-known UDP or TCP port numbers .
<i>-o</i>	Displays the process ID associated with each connection.
<i>-p <protocol></i>	Limits the display to only the information associated with the specified protocol.
<i><interval></i>	Causes the <i>netstat</i> command to be repeated every “<interval>” seconds, rather than just displaying its information once. This can be used with any of the <i>netstat</i> option groups. For example, “ <i>netstat -s 5</i> ” would display TCP/IP statistics every five seconds.

Sample Windows *netstat* Output

The output from the Windows *netstat* program is fairly similar to that of the UNIX utility when the same or similar options are given, but the UNIX version usually provides more details. I have shown in [Table 303](#) an example illustrating TCP/IP statistics on my home Windows XP machine, using “-p icmp” to restrict the output to ICMP stats only. [Table 304](#) shows the routing table display from *netstat* (which I modified slightly to fit the size limits of the table.) You would get similar output as these from the UNIX “*netstat -s -p icmp*” or “*netstat -r*” commands, but additional information would be provided.

Table 303: Sample ICMP Statistics From Windows *netstat* Utility

```
D:\aa>netstat -s -p icmp
ICMPv4 Statistics

                Received      Sent
Messages                243        248
Errors                   0           0
Destination Unreachable  9           4
Time Exceeded            7           0
Parameter Problems      0           0
Source Quenches         0           0
Redirects                0           0
Echos                   224        20
Echo Replies             3          224
Timestamps              0           0
Timestamp Replies       0           0
Address Masks           0           0
Address Mask Replies    0           0
```

Table 304: Sample Routing Table Display From Windows *netstat* Utility

```
D:\aa>netstat -r
Route Table
=====
Interface List
0x1 ..... MS TCP Loopback interface
0x2 ...00 04 76 4e 75 3f ..... 3Com 10/100 Mini PCI Ethernet
=====
Active Routes:
    Network Dest          Netmask          Gateway          Interface Met
    0.0.0.0          0.0.0.0    148.64.128.1    148.64.133.73    30
    127.0.0.0        255.0.0.0     127.0.0.1      127.0.0.1        1
    148.64.128.0     255.255.192.0 148.64.133.73  148.64.133.73    30
    148.64.133.73    255.255.255.255 127.0.0.1      127.0.0.1        30
    148.64.255.255  255.255.255.255 148.64.133.73  148.64.133.73    30
    224.0.0.0        240.0.0.0    148.64.133.73  148.64.133.73    30
    255.255.255.255  255.255.255.255 148.64.133.73  148.64.133.73    1
Default Gateway:    148.64.128.1
=====
Persistent Routes:
None
```



Key Concept: TCP/IP implementations include the *netstat* utility to allow information about network status to be displayed. On UNIX systems, *netstat* is a full-featured program with many options arranged into option groups, each of which shows a particular type of information about the operation of TCP/IP protocols. On Windows systems, *netstat* is somewhat more limited in function but still allows a considerable amount of information to be displayed.

TCP/IP Configuration Utilities (ipconfig, winipcfg and ifconfig)

A significant part of any network administrator's job is setting up and maintaining the devices that make a TCP/IP network function, a process generally called *configuration*. Networked hosts consist of both hardware and software that work together to implement all the layers and functions of the protocol stack. An administrator uses hardware tools to configure physical devices, performing tasks such as installing network interface cards, connecting cables, and manipulating switches and other hardware settings. Similarly, tools are required to configure the software that runs TCP/IP interfaces and controls the operation of higher-layer protocols on networked hosts.

The ifconfig Utility

On UNIX systems, the interface configuration utility, *ifconfig*, is used to view and modify the software settings that control how TCP/IP functions on a host. It is a very powerful program that allows an administrator to set up and manage a very wide array of network settings. The implementation of *ifconfig* varies greatly even between flavors of UNIX—while most are similar in general terms, they may have rather different options and syntaxes.

The *ifconfig* program can be used for a variety of purposes: to create or remove a network interface, change its settings, or simply examine the existing configuration. Thus, like the [netstat utility](#), *ifconfig* is really like several related programs combined into one, with the particular mode in which the program is used depending on the syntax used to invoke it. And also like *netstat*, *ifconfig* has a number of universal options that can be applied to many of its different uses.

***ifconfig* Syntaxes, Options and Parameters**

[Table 305](#) provides a simplified summary of the different functions that *ifconfig* can perform, and the syntaxes that are used to specify each in a typical UNIX implementation (NetBSD in this case). [Table 306](#) describes the common options and parameters that can be used for many of these different modes. When *ifconfig* is used to modify an interface's configuration,

this is done by setting any of several dozen configuration parameters, using the syntax shown in the last row of [Table 305](#); I have provided a brief description of some sample parameters in [Table 307](#) (see your *ifconfig* documentation for a complete list).

Table 305: Typical UNIX *ifconfig* Syntaxes, Options and Parameters

Syntax, Options and Parameters	Description
<i>ifconfig</i> [-L] [-m] <interface>	When <i>ifconfig</i> is called with just an interface specification and no other options (other than possibly “-L” and “-m”), it displays the configuration information for that network interface. Note that entering “ifconfig” by itself with no interface just causes help information for the parameter to be displayed; to see all interfaces, the “-a” parameter should be used.
<i>ifconfig -a</i> [-L] [-m] [-b] [-d] [-u] [-s] [<family>]	Displays information about all the interfaces on the host. The output may be restricted using the universal parameters shown, or by specifying an address family (see Table 306).
<i>ifconfig -l</i> [-b] [-d] [-u] [-s]	Lists all available interfaces on the system.
<i>ifconfig</i> <interface> create	Creates the specified logical network interface on the host, which is then configured using the syntax shown in the last row of this table. Note that some variations of UNIX allow certain parameters to be set at the time of creation.
<i>ifconfig</i> <interface> destroy	Destroys the specified logical interface.
<i>ifconfig</i> <interface> [<family>] [<address> [<dest_address>]] [<parameters>]	Configures parameters for a particular interface on the host. If the address is being set, it is the first parameter specified, after the optional address family, if present. The “<dest_address>” is used to specify a destination address for a point-to-point link. After this, any of several dozen parameters may be specified for the interface, some of which are shown in Table 307 .

Table 306: Typical UNIX *ifconfig* Universal Options and Parameters

Option / Parameter	Description
-L	Displays the address lifetime for IPv6 addresses.
-m	Displays all supported media for the interface.
-b	Limits the display of interface information to broadcast interfaces.
-d	Shows only interfaces that are presently down (disabled).
-u	Shows only interfaces that are presently up (operational).
-s	Shows only interfaces that may be connected.
<family>	Specifies a particular address family, either to limit output or indicate what address type is being configured. The value “inet” is used for IPv4 and “inet6” for IPv6.

Table 307: Typical UNIX *ifconfig* Interface Configuration Parameters

Parameters	Description
<i>alias</i> / <i>-alias</i>	Establishes or removes a network address alias.
<i>arp</i> / <i>-arp</i>	Enables / disables the use of ARP on this interface.
<i>delete</i>	Removes the specified network address.
<i>down</i>	Marks an interface as being “down”, disabling it.
<i>media</i> < <i>type</i> >	Sets the media type of the interface to a particular value.
<i>mtu</i> < <i>n</i> >	Sets the maximum transmission unit (MTU) of the interface.
<i>netmask</i> < <i>mask</i> >	Sets the network or subnet mask for the interface’s address.
<i>prefixlen</i> < <i>n</i> >	Same as “netmask” but allows the mask to be specified using a CIDR-style prefix length.
<i>up</i>	Sets an interface “up”, enabling it.



Note: Since creating, destroying or modifying interfaces can cause a host to stop working properly, administrative (super-user) rights are generally required on most systems in order to do anything with *ifconfig* other than examining the existing configuration.

ifconfig Sample Output

In [Table 308](#), I have provided a sample output of the “*ifconfig -a*” command on one of the UNIX machines I use regularly, showing the settings for its interfaces.

Table 308: Sample Routing Table Display From Windows *netstat* Utility

```
%ifconfig -a
fxp0: flags=8843<UP,BROADCAST,RUNNING,SIMPLEX,MULTICAST> mtu 1500
  address: 00:a0:c9:8c:f4:a1
  media: Ethernet autoselect (100baseTX full-duplex)
  status: active
  inet 166.84.1.3 netmask 0xffffffe0 broadcast 166.84.1.31
  inet alias 166.84.1.13 netmask 0xffffffff broadcast 166.84.1.13
lo0: flags=8009<UP,LOOPBACK,MULTICAST> mtu 33228
  inet 127.0.0.1 netmask 0xff000000
```

The *ipconfig* Utility

Windows takes a somewhat different approach to network configuration than UNIX. As we have seen, the UNIX *ifconfig* program can be used both to view and modify a wide range of configuration parameters. In Windows, however, most setup and parameter modification is done using the Windows Control Panel. Windows does include a utility that is somewhat

similar to UNIX's *ifconfig*, but it has far less functionality, and is used mainly to inspect the existing configuration, not change it. It also allows an administrator to easily perform a few simple functions on a host.

***ipconfig* Options and Parameters**

On most newer versions of Windows, the equivalent of *ifconfig* is a command-line utility called *ipconfig*. Like *ifconfig*, the Windows utility is controlled using options that are supplied to the program. However, because it is so much simpler than *ifconfig*, there are only a few different options that can be used. These are summarized in [Table 309](#).

Table 309: Typical Windows *ipconfig* Options and Parameters

Option / Parameters	Description
<i>(none)</i>	When called with no options or parameters, <i>ipconfig</i> displays the IP address, subnet mask and default gateway for each interface on the host.
<i>/all</i>	Similar to calling <i>ipconfig</i> with no options, but displays more detailed configuration information about the host's interfaces.
<i>/release [<adapter>]</i>	Releases (terminates) the DHCP lease on either the specified adapter (interface), or all interfaces if none is provided.
<i>/renew [<adapter>]</i>	Manually renews the DHCP lease for either the specified adapter (interface), or all adapters if none is mentioned.
<i>/displaydns</i>	Displays the contents of the host's DNS resolver cache.
<i>/flushdns</i>	Clears the host's DNS resolver cache.
<i>/registerdns</i>	Refreshes (renews) all DHCP leases and also re-registers any DNS names associated with the host.
<i>/showclassid <adapter></i>	Displays DHCP class IDs associated with this adapter (these are used to arrange clients into groups that are given different treatment by DHCP servers.) The adapter must be specified, even if there is only one.
<i>/setclassid <adapter> [<classid>]</i>	Modifies the DHCP class ID for the specified adapter.

As mentioned earlier, *ipconfig* is most often used to just examine the existing configuration. When simplified information is needed it is called with no options; an example of the output from this use of the command is shown in [Table 310](#). For detailed information on interfaces, the */all* option is used; an example is in [Table 311](#) (slightly modified so it is easier to read).

ipconfig Sample Output

You can see from the list of options in [Table 309](#) that most of the non-viewing uses of ipconfig are actually related not to configuring a host but rather controlling the operation of protocols such as [DNS](#) and [DHCP](#). One common use of *ipconfig* is to force a host to seek out a new [DHCP lease](#), which can be done using “ipconfig /release” followed by “ipconfig /renew”.

Table 310: Simplified Configuration Information From Windows *ipconfig* Utility

```
D:\aa>ipconfig
Windows IP Configuration

Ethernet adapter Local Area Connection 2:

    Connection-specific DNS Suffix  . :
    IP Address. . . . . : 148.64.133.73
    Subnet Mask . . . . . : 255.255.192.0
    Default Gateway . . . . . : 148.64.128.1
```

Table 311: Detailed Configuration Information From Windows *ipconfig* Utility

```
D:\aa>ipconfig /all
Windows IP Configuration

Host Name . . . . . : ixl
Primary Dns Suffix . . . . . :
Node Type . . . . . : Hybrid
IP Routing Enabled. . . . . : No
WINS Proxy Enabled. . . . . : No

Ethernet adapter Local Area Connection 2:

    Connection-specific DNS Suffix  . :
    Description . . . . . : 3Com PCI Ethernet Adapter
    Physical Address. . . . . : 00-04-76-4E-75-3F
    Dhcp Enabled. . . . . : Yes
    Autoconfiguration Enabled . . . . . : Yes
    IP Address. . . . . : 148.64.133.73
    Subnet Mask . . . . . : 255.255.192.0
    Default Gateway . . . . . : 148.64.128.1
    DHCP Server . . . . . : 148.64.128.1
    DNS Servers . . . . . : 148.78.249.200
                             148.78.249.201
    Lease Obtained. . . . . : April 19, 2003 11:51:37 AM
    Lease Expires . . . . . : April 19, 2003 12:21:37 PM
```

The *wipcfg* Utility

In earlier versions of Windows, a graphical tool called *wipcfg* is supplied (either instead of, or in addition to, the *ipconfig* command-line utility). This program allows configuration parameters to be examined in much the same way as *ipconfig*, and also allows DHCP leases to be released and renewed, but does not support the other options of *ipconfig* (such as displaying the host's DNS cache). An example of the main *wipcfg* screen is shown in Figure 322.

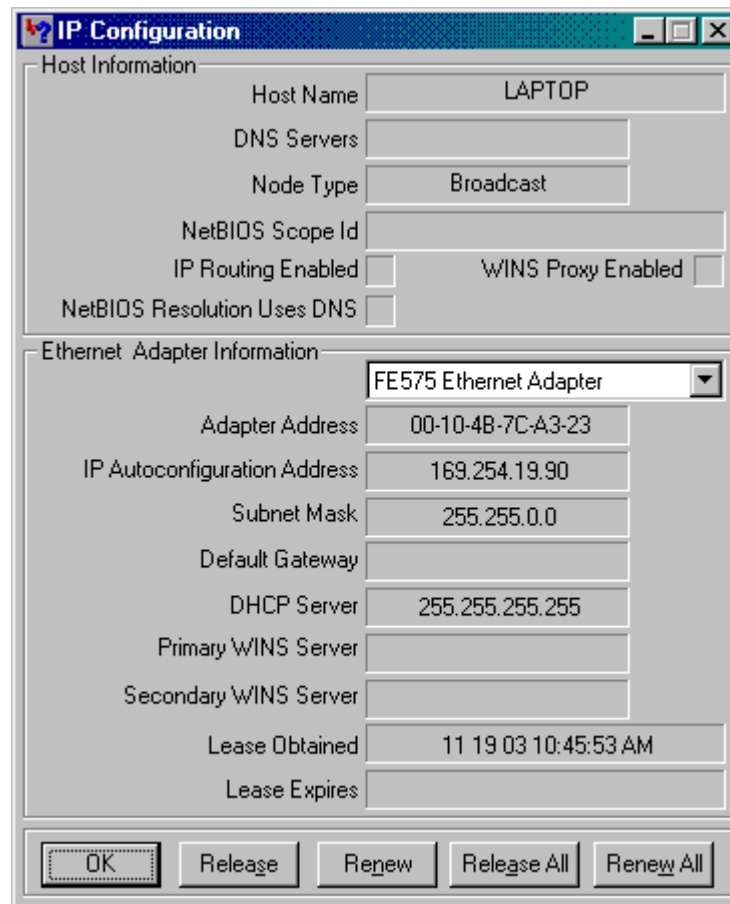

Figure 322: Windows 95/98/ME *wipcfg* Utility

The *wipcfg* utility can be used in older consumer-oriented versions of Windows to check the configuration of a host and release/renew DHCP leases.



Key Concept: On UNIX systems, the *ifconfig* utility can be used to display or modify a large number of TCP/IP configuration settings. Windows systems provide either the command-line utility *ipconfig* or the graphical tool *wipcfg*. Both let an administrator see basic TCP/IP configuration information for a host and allow tasks to be performed such as renewing a DHCP lease, but they are otherwise quite limited compared to the UNIX *ifconfig* program.

Miscellaneous TCP/IP Troubleshooting Protocols: Echo, Discard, Character Generator, Quote Of The Day, Active Users, Daytime, Time

The old quip says that the only guarantees in life are death and taxes. When it comes to networking, you can add a few more, including this one: as soon as you set up a network, it will very quickly develop problems that you will need to address. Recognizing that the complexity of TCP/IP internetworks would make diagnosing certain problems difficult, the suite's architects defined a number of miscellaneous utility protocols that can be helpful in testing and troubleshooting networks. Despite having been around for over 20 years, these protocols are somewhat obscure and get little attention. I too will not devote much time to them (since they are no longer implemented on many systems) but I do feel they are worth a quick look.

These simple protocols are designed to be implemented as services that run on TCP/IP servers. Each listens for requests on a dedicated [well-known port number](#), and then responds with a particular type of information. These protocols can be used with both TCP and UDP, enabling each transport protocol to be tested. In the case of UDP, the server counts each UDP sent to it as a request, and sends a response to it. When used with TCP, a connection is of course first established by the client to the server. In some of the protocols, this connection is then used to send data continuously between the client and server; in others, the establishment of the connection is considered an implied request to the server, which will immediately send a response and then close the connection.

[Table 312](#) provides a brief description of each of these troubleshooting protocols/services under both UDP and TCP. I have shown for each the port number that the service uses, and also the RFC that defines it, if you want additional information.

Table 312: Miscellaneous TCP/IP Troubleshooting Protocols (Page 1 of 2)

Protocol	Well-Known Port Number	Defining RFC	Description
Echo Protocol	7	862	Echoes received data back to its originator. When used on UDP, the payload of each message is simply packaged into a return UDP datagram and sent back. For TCP, each byte sent by the client is echoed back by the server until the connection is closed.
Discard Protocol	9	863	Throws away all data that is sent to it. I think this should be called the "Black Hole Protocol". ☺

Table 312: Miscellaneous TCP/IP Troubleshooting Protocols (Page 2 of 2)

Protocol	Well-Known Port Number	Defining RFC	Description
Character Generator Protocol	19	864	Generates random characters of data and sends them to a device. When used with UDP, each UDP message sent to the server causes it to send back a UDP message containing a random number (0 to 512 bytes) of data. When used with TCP, the server just starts sending characters as soon as a client establishes a connection, and continues until the connection is terminated by the client.
Quote of the Day Protocol	17	865	Sends a short message (selected by the server's administrator) to a client device. For UDP, the message is sent for each incoming UDP message; for TCP, the message is sent by the server once when the connection is established, which is then closed.
Active Users	11	866	Sends a list of active users to a device. For UDP, the list is sent for each incoming UDP message; if it is longer than 512 bytes it will be sent in multiple messages. For TCP, the list is sent automatically when the connection is made to the server, and then the connection is terminated.
Daytime Protocol	13	867	Returns the current time on the server in human-readable form, in response to receipt of a UDP message or an incoming TCP connection.
Time Protocol	37	868	Returns the current time in machine-readable form—specifically, the number of seconds since midnight, January 1, 1900 GMT. The time is sent for each UDP message received by the server, or upon establishment of a TCP connection. Note that this protocol cannot be used for time synchronization of servers, because it does not compensate for variability in the time required for the messages to be carried over the internetwork.

